

Amika

Price List
Lista de precios - Listino prezzi

2017





Index - Índice - Indice

2	230X	glasswasher	32	9XLE	utensilwasher
4	240X	glasswasher	34	9HXLE	utensilwasher
6	250X	glasswasher	36	Rack Cestas - Cesti	
8	260X	dishwasher	48	Detergents Detergencia - Detergenza	
10	260XL	dishwasher	50	Conditions of sales Condiciones de venta - Condizioni di vendita	
12	280X	hoodtype			
14	Accessories for Hood-type Accesorios para Lavavajillas de cúpula - Accessori per Capot				
20	101XL	rackconveyor			
22	102XL	rackconveyor			
24	Accessories for Rack-Conveyor Accesorios para lavavajillas de arrastre - Accessori per Traino				

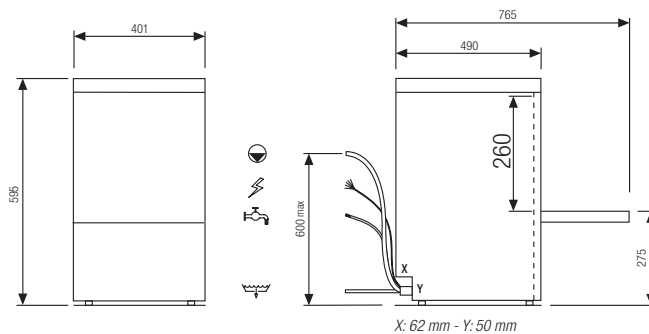
230X





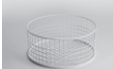



Model - Modelo - Modello	Cod.	€
230X	917844	1.230,00
230XD	917845	1.320,00
230XR	917903	-----

Standard Equipment - Equipamiento - Dotazioni	Cod.
 n. 2	781038
 n. 1	780139
 n. 2 (round rack version - versión cesta redonda - versione con cesto rotondo)	706095

*D: peristaltic detergent dispenser - dosificador de detergente peristáltico - dosatore detergente peristaltico
 *R: round rack version - versión cesta redonda - versione con cesto rotondo

Technical data - Datos técnicos - Dati tecnici

Dimension - Dimensiones - Dimensioni		cm	40.1x49x59.5
Door opening height - Altura puerta - Apertura porta		cm	26
Dish max. height - Altura máxima plato - Altezza max piatto		cm	-
Glass max. height - Altura máxima vaso - Altezza max bicchiere		cm	25
Washing cycle - Ciclo de lavado - Ciclo di lavaggio		sec.	120
Rack - Cesta - Cesto		cm	35x35 - Ø35
Water consumption - Consumo de agua - Consumo acqua		L/cycle - L/ciclo - L/ciclo	2
Wash pump - Bomba propulsora - Pompa di lavaggio		kW	0.15
		L	7
Tank - Cuba - Vasca		kW	0.6
		°C	60
		L	2.6
Booster - Calderín - Boiler		kW	2.6
		°C	65
Peristaltic rinse dispenser - Dosificador peristáltico de abrillantador - Dosatore brillantante peristaltico			✓

Optional	Cod.	€	Installed power Potencia instalada - Potenza Installata	Amp.	kW
Drain pump Bomba de desagüe - Pompa scarico	999354	160,00	230 V - 50 Hz - 1N	16	3.5
Detergent dispenser Dosificador de detergente - Dosatore detergente	999347	190,00	Available -Disponibile - Disponibile		
			230 V - 60 Hz - 1N	16	3.5

240X

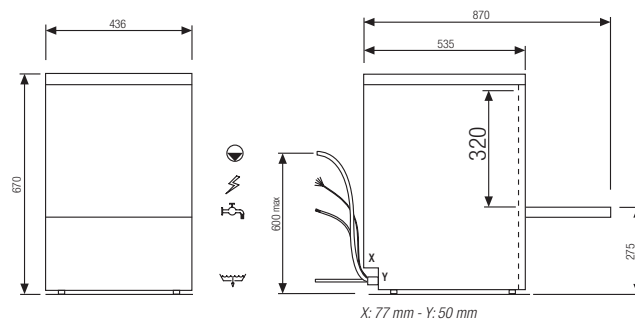

Model - Modelo - Modello	Cod.	€
240X	917846	1.460,00
240XD	917847	1.550,00
240XDP	917905	-----
240XR	917904	-----

Standard Equipment - Equipamiento - Dotazioni

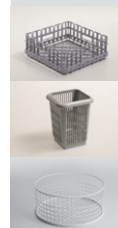

n. 2

780133

n. 1

780139







n. 1+1
(round rack version - versión cesta redonda
versione con cesto rotondo)

983060

983015

*D: peristaltic detergent dispenser - dosificador de detergente peristáltico - dosatore detergente peristaltico
 **DP: peristaltic detergent dispenser and drain pump - dosi cadór de detergente peristáltico y bomba de desagüe - dosatore detergente peristaltico e pompa scarico
 ***R: round rack version - versión cesta redonda - versione con cesto rotondo

Technical data - Datos técnicos - Dati tecnici



Dimension - Dimensiones - Dimensioni		cm	43.6x53.5x67
Door opening height - Altura puerta - Apertura porta		cm	32
Dish max. height - Altura máxima plato - Altezza max piatto		cm	30
Glass max. height - Altura máxima vaso - Altezza max bicchiere		cm	30
Washing cycle - Ciclo de lavado - Ciclo di lavaggio		sec.	120
Rack - Cesta - Cesto		cm	39x39 - Ø39
Water consumption - Consumo de agua - Consumo acqua		L/cycle - L/ciclo - L/ciclo	2
Wash pump - Bomba propulsora - Pompa di lavaggio		kW	0.2
		L	8
Tank - Cuba - Vasca		kW	0.6
		°C	60
		L	2.6
Booster - Calderín - Boiler		kW	2.6
		°C	65
Peristaltic rinse dispenser - Dosificador peristáltico de abrillantador - Dosatore brillantante peristaltico			✓

Optional	Cod.	€	Installed power Potencia instalada - Potenza Installata	Amp.	kW
Drain pump Bomba de desagüe - Pompa scarico	999354	160,00	230 V - 50 Hz - 1N	16	3.5
Detergent dispenser Dosificador de detergente - Dosatore detergente	999347	190,00	Available -Disponibile - Disponibile		
			230 V - 60 Hz - 1N	16	3.5

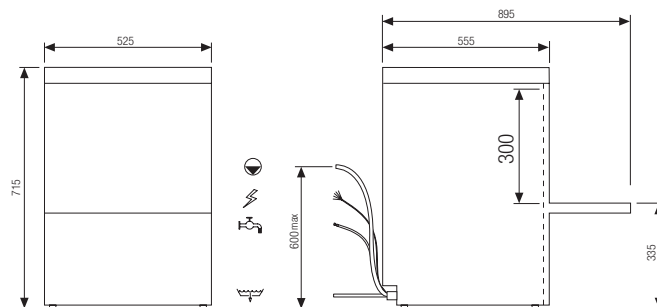
250X





Model - Modelo - Modello	Cod.	€
250X	917848	1.860,00
250XD	917849	1.950,00

Standard Equipment - Equipamiento - Dotazioni		Cod.
	n. 1	780129
	n. 1	780128
	n. 1	780139

* D: peristaltic detergent dispenser - dosificador de detergente peristáltico - dosatore detergente peristaltico

Technical data - Datos técnicos - Dati tecnici



Dimension - Dimensiones - Dimensioni		cm	52.5x55.5x71.5
Door opening height - Altura puerta - Apertura porta		cm	30
Dish max. height - Altura máxima plato - Altezza max piatto		cm	28
Glass max. height - Altura máxima vaso - Altezza max bicchiere		cm	28
Washing cycle - Ciclo de lavado - Ciclo di lavaggio		sec.	120
Rack - Cesta - Cesto		cm	45x45
Water consumption - Consumo de agua - Consumo acqua		L/cycle - L/ciclo - L/ciclo	2
Wash pump - Bomba propulsora - Pompa di lavaggio		kW	0.2
		L	14
Tank - Cuba - Vasca		kW	0.6
		°C	60
Booster - Calderín - Boiler		L	2.6
		kW	2.6
Peristaltic rinse dispenser - Dosificador peristáltico de abrillantador - Dosatore brillantante peristaltico		°C	65 - 80
			✓

Optional	Cod.	€	Installed power Potencia instalada - Potenza Installata	Amp.	kW
Drain pump Bomba de desagüe - Pompa scarico	999357	190,00	230 V - 50 Hz - 1N	16	3.5
Detergent dispenser Dosificador de detergente - Dosatore detergente	999347	190,00	Available -Disponibile - Disponibile		
			230 V - 60 Hz - 1N	16	3.5

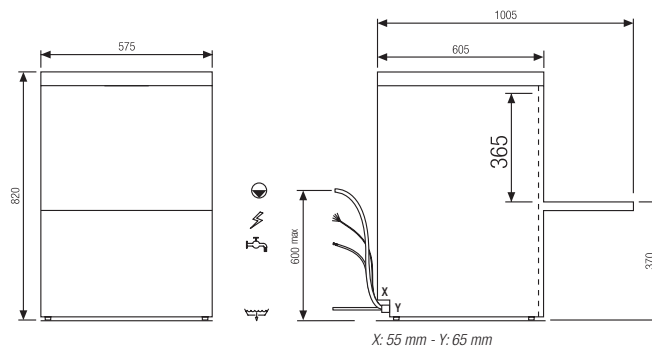
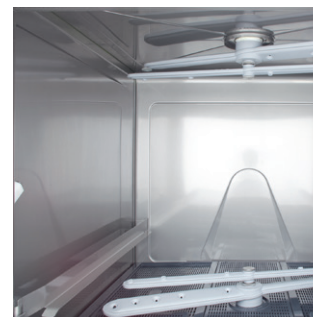
260X



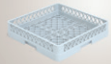





Model - Modelo - Modello	Cod.	€
260X	917850	2.060,00
260XD	917851	2.150,00

Standard Equipment - Equipamiento - Dotazioni		Cod.
	n. 1	780131
	n. 1	780132
	n. 1	780139

* D: peristaltic detergent dispenser - dosificador de detergente peristáltico - dosatore detergente peristaltico

Technical data - Datos técnicos - Dati tecnici

Dimension - Dimensiones - Dimensioni		cm	57.5x60.5x82
Door opening height - Altura puerta - Apertura porta		cm	36.5
Dish max. height - Altura máxima plato - Altezza max piatto		cm	36.5
Glass max. height - Altura máxima vaso - Altezza max bicchiere		cm	32.5
Washing cycle - Ciclo de lavado - Ciclo di lavaggio		sec.	60 -120
Rack - Cesta - Cesto		cm	50x50
Water consumption - Consumo de agua - Consumo acqua		L/cycle - L/ciclo - L/ciclo	2.4
Wash pump - Bomba propulsora - Pompa di lavaggio		kW	0.5
		L	20
Tank - Cuba - Vasca		kW	2.1
		°C	60
		L	6
Booster - Calderín - Boiler		kW	3
		°C	80
Peristaltic rinse dispenser - Dosificador peristáltico de abrillantador - Dosatore brillantante peristaltico			✓



Optional	Cod.	€
Drain pump Bomba de desagüe - Pompa scarico	999342	190,00
Detergent dispenser Dosificador de detergente - Dosatore detergente	999347	190,00
Composit tank strainer - Filtro cuba en material compuesto - Filtri vasca in materiale composito	121994	70,00

Installed power Potencia instalada - Potenza Installata	Amp.	kW
230 V - 50 Hz - 1N	16	3.5
Available -Disponibile - Disponibile		
230 V - 60 Hz - 1N	16	3.5

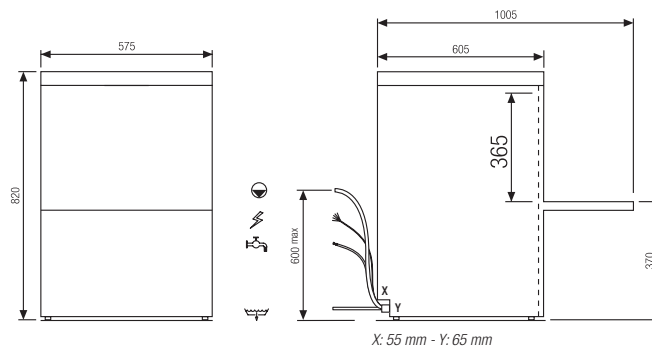
260XL



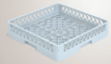





Model - Modelo - Modello	Cod.	€
260XL	917852	2.160,00
260XLD	917853	2.250,00

Standard Equipment - Equipamiento - Dotazioni		Cod.
	n. 1	780131
	n. 1	780132
	n. 1	780139

* D: peristaltic detergent dispenser - dosificador de detergente peristáltico - dosatore detergente peristaltico

Technical data - Datos técnicos - Dati tecnici

Dimension - Dimensiones - Dimensioni		cm	57.5x60.5x82
Door opening height - Altura puerta - Apertura porta		cm	36.5
Dish max. height - Altura máxima plato - Altezza max piatto		cm	36.5
Glass max. height - Altura máxima vaso - Altezza max bicchiere		cm	32.5
Washing cycle - Ciclo de lavado - Ciclo di lavaggio		sec.	60 -120
Rack - Cesta - Cesto		cm	50x50
Water consumption - Consumo de agua - Consumo acqua		L/cycle - L/ciclo - L/ciclo	2.4
Wash pump - Bomba propulsora - Pompa di lavaggio		kW	0.5
		L	20
Tank - Cuba - Vasca		kW	2.1
		°C	60
		L	6
Booster - Calderín - Boiler		kW	4.9
		°C	80
Peristaltic rinse dispenser - Dosificador peristáltico de abrillantador - Dosatore brillantante peristaltico			✓

Optional	Cod.	€
Drain pump Bomba de desagüe - Pompa scarico	999342	190,00
Detergent dispenser Dosificador de detergente - Dosatore detergente	999347	190,00
Composit tank strainer - Filtro cuba en material compuesto - Filtri vasca in materiale composito	121994	70,00

Installed power Potencia instalada - Potenza Installata	Amp.	kW
400 V - 50 Hz - 3N	16	5.4
Available -Disponibile - Disponibile		
400 V - 60 Hz - 3N	16	5.4

280XL

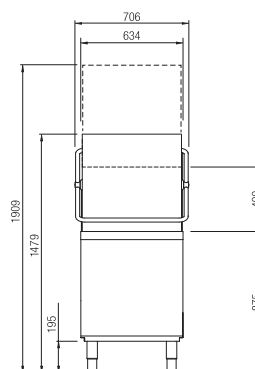

Height - Altura - Altezza: ± 3 cm

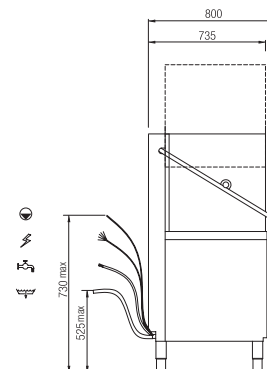

Model - Modelo - Modello

Cod.

€

280XL

TH50STAMK

3.710,00

Standard Equipment - Equipamiento - Dotazioni

Cod.

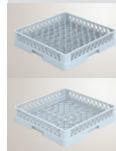

n. 1

780131

n. 1





780132

Technical data - Datos técnicos - Dati tecnici



Dimension - Dimensiones - Dimensioni		cm	63.5x73.5x148
Door opening height - Altura puerta - Apertura porta		cm	40
Dish max. height - Altura máxima plato - Altezza max piatto		cm	40
Glass max. height - Altura máxima vaso - Altezza max bicchiere		cm	39
Washing cycle - Ciclo de lavado - Ciclo di lavaggio		sec.	60 - 120
Rack - Cesta - Cesto		cm	50x50
Water consumption - Consumo de agua - Consumo acqua		L/cycle - L/ciclo - L/ciclo	2.4
Wash pump - Bomba propulsora - Pompa di lavaggio		kW	0.5
		L	15
Tank - Cuba - Vasca		kW	2.1
		°C	60
		L	6
Booster - Calderin - Boiler		kW	8
		°C	80
ThermoStop			✓
Peristaltic rinse dispenser - Dosificador peristáltico de abrillantador - Dosatore brillantante peristaltico			✓

Optional	Cod.	€	Installed power Potencia instalada - Potenza Installata	Amp.	kW
Drain pump Bomba de desagüe - Pompa scarico	70710	190,00	400 V - 50 Hz - 3N	16	8.5
Detergent dispenser Dosificador de detergente - Dosatore detergente	41954	182,00	Available -Disponibile - Disponibile		
Composit tank strainer - Filtro cuba en material compuesto - Filtri vasca in materiale composito	69820	70,00	400 V - 60 Hz - 3N	16	8.5



Accessories for Hood-type
Accesorios para Lavavajillas de cúpula
Accessori per Capot

	Mod.	Dim. (cm)	Cod.	€
	P 70	70x57.5x85	80202	350,00
	PA 70 DX	70x71.5x85	80200	465,00
	PA 70 SX	70x71.5x85	80201	465,00
	PA 120 DX	120x71.5x85	80204	650,00



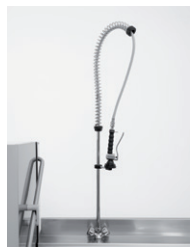

Accessories for Hood-type
Accesorios para Lavavajillas de cúpula
Accessori per Capot

	Mod.	Dim. (cm)	Cod.	€
	PA 120 SX	120x71.5x85	80203	650,00
	PAL 70 DX	70x71.5x85	80206L700	1.015,00
	PAL 70 SX	70x71.5x85	80205L700	1.015,00
	PAL 120DX	120x71.5x85	80206	1.015,00



Accessories for Hood-type
Accesorios para Lavavajillas de cúpula
Accessori per Capot

	Mod.	Dim. (cm)	Cod.	€
	PAL 120SX	120x71.5x85	80205	1.015,00
	PALS 120 DX	120x71.5x85	80208	1.095,00
	PALS 120 SX	120x71.5x85	80207	1.095,00
	Pre-wash shower Ducha Gruppo doccia		799003	290,00





Accessories for Hood-type
Accesorios para Lavavajillas de cúpula
Accessori per Capot

	Mod.	Dim. (cm)	Cod.	€
	Caster mounted cylindrical garbage Contenedor de basura Pattumiera carrellata in acciaio inox	Ø 40 - h 70	704002	340,00
	Rubber ring Anillo de goma Anello in gomma		199064	70,00
	Open inox plinth Soporte abierto Zoccolo inox aperto (EW560-EW563)	57,6x55,6x37,4 H	798005	258,00
	Closed inox plinth Soporte cerrado Zoccolo inox chiuso (EW560-EW563)	57,5x56,6x(min38,9-max45,4 H)	798006	320,00

Accessories for Hood-type Accesorios para Lavavajillas de cúpula Accessori per Capot

	Mod.	Cod.	€	
		EW530 - EW540	999354	160,00
	Drain pump kit Kit bomba de desagüe Kit pompa scarico	EW 550	999357	190,00
		EW 560 - EW 563	999342	190,00
		EW 580 - EW 583	70710	190,00
		EW 530/540/550/560/563	999347	190,00
	Detergent dispenser kit Kit dosificador de detergente Kit dosatore detergente	EW 580/583	41953	182,00
	Rinse aid dispenser kit Kit dosificadores de abrillan- tador Kit dosatore brillantante	EW 3101/3103/3104/3105	41952	182,00

Water softner Suavizador Addolcitore

	Mod.	Dim. (cm)	Cod.	€
	Manual water softner 8L Suavizador manual 8L Addolcitore manuale 8L	24 x 19 x 42	708001	115,00
	Manual water softner 12L Suavizador manual 12L Addolcitore manuale 12L	24 x 19 x 42	708002	126,00
	Manual water softner 16L Suavizador manual 16L Addolcitore manuale 16L	24 x 19 x 62	708003	172,00
	Manual water softner 20L Suavizador manual 20L Addolcitore manuale 20L	24 x 19 x 71	708004	205,00

101XL

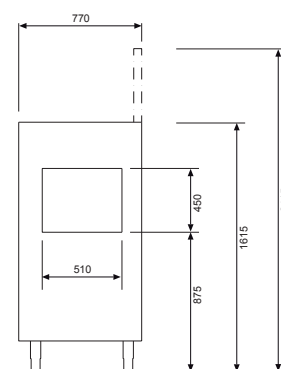
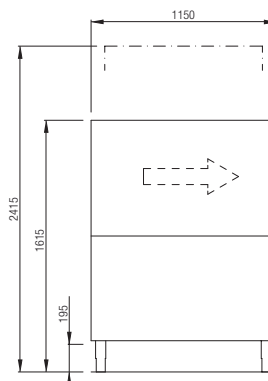
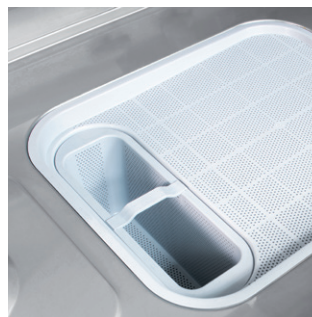

Height - Altura - Altezza: ± 3 cm

Model - Modelo - Modello

Cod.

€

101XL
(exit rack: R - salida cesta: DCHO - uscita cesto: DX)

T101AMKD

9.000,00

101XL
(exit rack: L - salida cesta: IZDO - uscita cesto: SX)

T101AMKS

9.000,00

Standard Equipment - Equipamiento - Dotazioni

Cod.



n. 1

780072



n. 1





780135



n. 1

780139

Technical data - Datos técnicos - Dati tecnici

Dimension - Dimensiones - Dimensioni		cm	77x115x161
Door opening height - Altura puerta - Apertura porta		cm	45
Dish max. height - Altura máxima plato - Altezza max piatto		cm	46
Glass max. height - Altura máxima vaso - Altezza max bicchiere		cm	44
Productivity - Producción - Produttività		rack/h - cesti/h - cestas/h	60 - 120
Rack - Cesta - Cesto		cm	50x50
Water consumption - Consumo de agua - Consumo acqua		L/h	160
Wash pump - Bomba propulsora - Pompa di lavaggio		kW	1.5
		L	70
Tank - Cuba - Vasca		kW	10.5
		°C	60
		L	17
Booster - Calderín - Boiler		kW	9.5
		°C	82
Composit tank strainer - Filtro cuba en material compuesto - Filtri vasca in materiale composito			✓

Installed power Potencia instalada - Potenza Installata	kW	kW (6.55)	kW (9.55)
Maximum power absorption with 50 °C water feed Potencia maxima con agua a 50 °C - Assorbimento massimo con acqua a 50 °C		With dry unit Con módulo secado Con asciugatura	
400 V - 50/60 Hz - 3N	22	28.55	31.55
Maximum power absorption with 15 °C water feed Potencia maxima con agua a 15 °C - Assorbimento massimo con acqua a 15 °C			
400 V - 50/60 Hz - 3N	28.5	35.05	38.05
Maximum power absorption with 15 °C water feed and heat recovery system Potencia maxima con agua a 15 °C con recuperador de vahos - Assorbimento massimo con acqua a 15 °C e recuperatore di calore			
400 V - 50/60 Hz - 3N	24.7	31.25	34.25

102XL

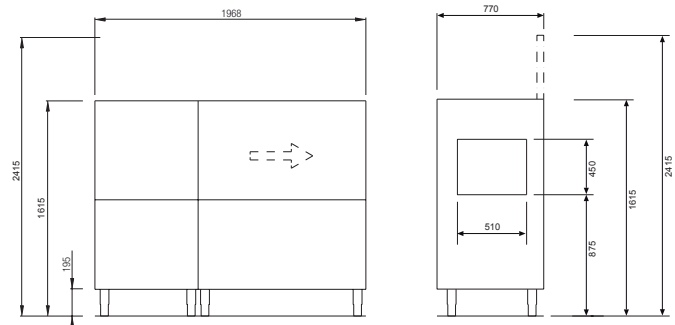

Height - Altura - Altezza: ± 3 cm

Model - Modelo - Modello

Cod.

€

102XL
(exit rack: R - salida cesta: DCHO - uscita cesto: DX)

T102AMKD

15.450,00

102XL
(exit rack: L - salida cesta: IZDO - uscita cesto: SX)

T102AMKS

15.450,00

Standard Equipment - Equipamiento - Dotazioni

Cod.



n. 1

780072

n. 1

780135

n. 1

780139

Technical data - Datos técnicos - Dati tecnici



Dimension - Dimensiones - Dimensioni		cm	77x197x161
Door opening height - Altura puerta - Apertura porta		cm	45
Dish max. height - Altura máxima plato - Altezza max piatto		cm	46
Glass max. height - Altura máxima vaso - Altezza max bicchiere		cm	44
Productivity - Producción - Produttività		rack/h - cesti/h - cestas/h	110 - 200
Rack - Cesta - Cesto		cm	50x50
Water consumption - Consumo de agua - Consumo acqua		L/h	270
Wash pump - Bomba propulsora - Pompa di lavaggio		kW	1.5
Prewash pump - Bomba de prelavado - Pompa di prelavaggio		kW	1.5
Prewash tank - Cuba de prelavado - Vasca di prelavaggio		L	70
Tank - Cuba - Vasca		L	70
		kW	10.5
		°C	60
		L	17
Booster - Calderín - Boiler		kW	15.5
		°C	82
Composit tank strainer - Filtro cuba en material compuesto - Filtri vasca in materiale composito			✓

Installed power Potencia instalada - Potenza Installata	kW	kW (6.55)	kW (9.55)
Maximum power absorption with 50 °C water feed Potencia maxima con agua a 50 °C - Assorbimento massimo con acqua a 50 °C		With dry unit Con módulo secado Con asciugatura	
400 V - 50/60 Hz - 3N	29.5	36.05	39.05
Maximum power absorption with 15 °C water feed Potencia maxima con agua a 15 °C - Assorbimento massimo con acqua a 15 °C			
400 V - 50/60 Hz - 3N	41	47.55	50.55
Maximum power absorption with 15 °C water feed and heat recovery system Potencia maxima con agua a 15 °C con recuperador de vahos - Assorbimento massimo con acqua a 15 °C e recuperatore di calore			
400 V - 50/60 Hz - 3N	34.2	40.75	43.75

Accessories for Rack-Conveyor

Accesorios para lavavajillas de arrastre

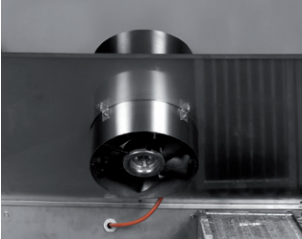

Accessori per Traino

	Mod.	Dim. (cm)	m ³ /h	Volt/kW	Cod.	€
	Line drying zone Módulo de secado Zona asciugatura elettrica	60x77x177.5	1400	400/50/3N 6.55 kW	A	4.250,00
				400/50/3N 9.55 kW	L	4.565,00
	Corner drying zone Módulo de secado en ángulo Zona asciugatura ad angolo	82x87.9x177.5	1400	400/50/3N 6.55 kW	B	8.370,00
				400/50/3N 9.55 kW	I	8.650,00
	Pressure reducer with pressure gauge Válvula reductor de presión Riduttore di pressione	99x82x161			N	255,00
	Exhaust port Collar con aspirador Collarino e aspirazione vapori	Ø 25 - h 21	700	400/50/3N 0.2 kW	E	1.050,00

Accessories for Rack-Conveyor

Accesorios para lavavajillas de arrastre

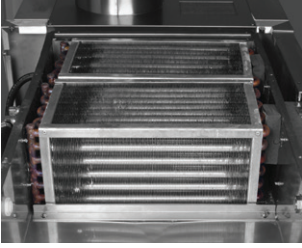
Accessori per Traino

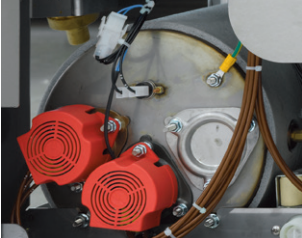
	Mod.	Dim. (cm)	m ³ /h	Volt/kW	Cod.	€
	Corner pre-washing Suplemento prelavado en ángulo Prelavaggio ad angolo	99x82x161			P	2.190,00
	Heat recovery Recuperador de vahos Recuperatore calore	Ø 25 - h 21	700	400/50/3N 0.2 kW	R	3.610,00
	Rinse aid and detergent dispenser Dosificadores de detergente y abrillantador Dosatore detersivo e brillantante installato				Y	378,00
	Powered booster Suplemento resistencia calderin Alimentazione ad acqua fredda			9.5 kW	W	280,00

Accessories for Rack-Conveyor

Accesorios para lavavajillas de arrastre

Accessori per Traino

	Mod.	Dim. (cm)	m ³ /h	Volt/kW	Cod.	€
	Drying kit (right exit machine) Módulo de secado kit (maquina salida derecha) Kit zona asciugatura elettrica (macchina uscita DX)	60x77x177.5	1400	400/50/3N 6.0 kW	65588D	4.750,00
	Drying kit (left exit machine) Módulo de secado kit (maquina salida izquierda) Kit zona asciugatura elettrica (macchina uscita SX)	60x77x177.5	1400	400/50/3N 6.0 kW	65588S	4.750,00
	Rinse aid and detergent dispensers kit Kit dosificadores de detergente y abrillantador Kit dosatore detersivo e brillantante installato				65850	395,00
	Powered booster kit Kit suplemento resistencia calderin Kit alimentazione ad acqua fredda			9.5 kW	65587	342,00



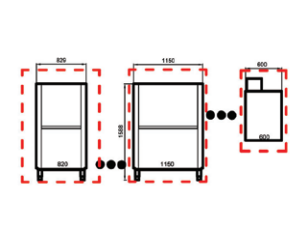

Accessories for Rack-Conveyor
Accesorios para lavavajillas de arrastre
Accessori per Traino

	Mod.	Dim. (cm)	m³/h	Volt/kW	Cod.	€
	End switch for roller table and table kit Kit final de carrera para mesar Kit micro finecorsa per tavoli e rulliere				75861	165,00
	Separate moduls shipment Envío módulos separados Spedizione moduli separati					Su richiesta

Accessories for Rack-Conveyor

Accesorios para lavavajillas de arrastre





Accessori per Traino

	Mod.	Dim. (cm)	Cod.	€
	Entry or exit table Mesa entrada salida Piano entrata/uscita	70x70x85	75482	596,00
		110x70x85	75483	612,00
	Exit table with drying module Mesa entrada salida para secado Piano uscita con zona asciugatura	70x70x85	75484	655,00
		110x70x85	75485	684,00
	Mechanized rack-feeding corner unit for right exit machine Mesa esquina mecanizada para máquina salida derecha Piano laterale angolo meccanizzato per macchina uscita DX	60x65x85	75480	1.628,00
	Mechanized rack-feeding corner unit for left exit machine Mesa esquina mecanizada para máquina salida izquierda Piano laterale angolo meccanizzato per macchina uscita SX	60x65x85	75481	1.628,00

Accessories for Rack-Conveyor

Accesorios para lavavajillas de arrastre





Accessori per Traino

	Mod.	Dim. (cm)	Cod.	€
	Sorting table with sink and splashguard for right machine	120x70x85	75451	1.185,00
	Mesa selección con cuba para máquina salida derecha	150x70x85	75452	1.288,00
	Piano di cernita con vasca e azatina per macchina uscita DX	180x70x85	75453	1.364,00
	Sorting table with sink and splashguard for left machine	120x70x85	75456	1.185,00
	Mesa selección con cuba para máquina salida izquierda	150x70x85	75457	1.288,00
	Piano di cernita con vasca e azatina per macchina uscita SX	180x70x85	75458	1.364,00
	Sorting table with sink, dump hole and splashguard for right exit machine	120x70x85	75446	1.352,00
	Mesa selección con cuba, peto y desbrascado para máquina salida derecha	150x70x85	75447	1.515,00
	Piano di cernita con vasca, sbarazzo e alzatina per macchina uscita DX	180x70x85	75448	1.662,00
	Sorting table with sink, dump hole and splashguard for left exit machine	120x70x85	75441	1.353,00
	Mesa selección con cuba, peto y desbrascado para máquina salida izquierda	150x70x85	75442	1.515,00
	Piano di cernita con vasca, sbarazzo e alzatina per macchina uscita SX	180x70x85	75443	1.662,00



Accessories for Rack-Conveyor

Accesorios para lavavajillas de arrastre

Accessori per Traino

	Mod.	Dim. (cm)	Cod.	€
	Straight roller unit with basin and legs with limit switch	110 (114,5)x63x87.5	717066	1.340,00
	Rodillos con cuba palatas y final de carrera	160 (164,5)x63x87.5	717067	1.782,00
	Rulliera rettilinea con vasca, gambe e fine corsa	210 (214,5)x63x87.5	717086	2.360,00
	A= + 4,5 cm	260 (264,5)x63x87.5	717087	2.910,00
	Mobile roller unit with baff e-type limit switch	114.5x64x87.5	717069	2.360,00
	Rodillos con cuba palatas sobre ruedas y final de carrera	164.5x64x87.5	717070	2.782,00
	Rulliera mobile con fine corsa	214.5x64x87.5	717088	3.735,00
	90° roller curve with basin and legs	110x110x87.5	717068	1.995,00
Curva con rodillos 90°				
Curva a rulli a 90° con vasca e gambe				
	90° machine-moved curve only for unloading	80x80x87.5	75500	3.625,00
Curva mecanizada 90°				
Curva meccanizzata a 90° per scarico				

Accessories for Rack-Conveyor
Accesorios para lavavajillas de arrastre
Accessori per Traino

	Mod.	Dim. (cm)	Cod.	€
	180° machine-moved curve only for unloading right exit Curva mecanizada 180° salida derecha Curva meccanizzata a 180° per scarico uscita destra	140x80x87.5	75660DX	5.830,00
	180° machine-moved curve only for unloading left exit Curva mecanizada 180° salida izquierda Curva meccanizzata a 180° per scarico uscita sinistra		75660SX	5.830,00
	Rubber ring Anilo de goma Anello in gomma		199064	70,00

9XLE

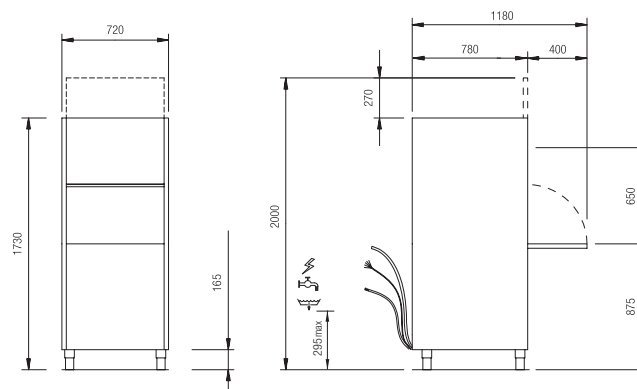
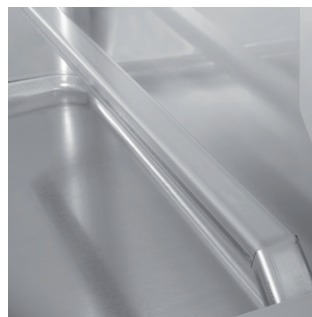

Height - Altura - Altezza: ± 3 cm

Model - Modelo - Modello

Cod.

€

9XLE

NT901AMK

5.150,00

Standard Equipment - Equipamiento - Dotazioni





Cod.



n. 1

41305

Technical data - Datos técnicos - Dati tecnici

Dimension - Dimensiones - Dimensioni		cm	72x78x170
Door opening height - Altura puerta - Apertura porta		cm	65
Washing cycle - Ciclo de lavado - Ciclo di lavaggio		min.	2 - 4 - 8 - ∞
Rack - Cesta - Cesto		cm	56x63
Water consumption - Consumo de agua - Consumo acqua		L/cycle - L/ciclo - L/ciclo	4
Wash pump - Bomba propulsora - Pompa di lavaggio		kW	1.4
		L	37
Tank - Cuba - Vasca		kW	3
		°C	55
Booster - Calderín - Boiler		L	7
		kW	6
		°C	80
Tank strainer - Filtro cuba - Filtri vasca			✓

Optional	Cod.	€	Installed power Potencia instalada - Potenza Installata	Amp.	kW
Rinse dispenser Dosificador de abrillantador - Dosatore brillantante	41952	178,00	400 V - 50 Hz - 3N	16	7.4
Detergent dispenser Dosificador de detergente - Dosatore detergente	41953	178,00	Available -Disponibile - Disponibile		
			400 V - 60 Hz - 3N	16	7.4

9HXLE

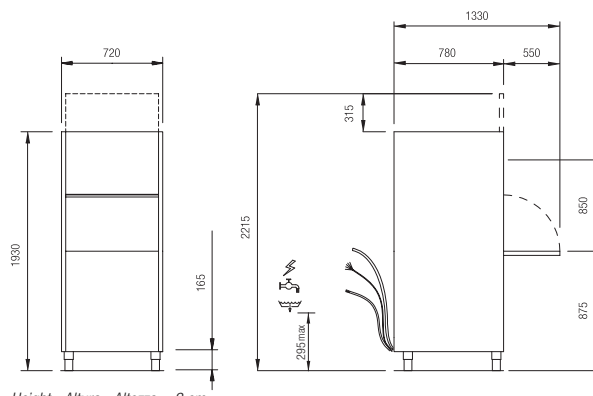

Model - Modelo - Modello

Cod.

€

9HXLE

NT902AMK

5.960,00

Standard Equipment - Equipamiento - Dotazioni





Cod.



n. 1



41305

Technical data - Datos técnicos - Dati tecnici

Dimension - Dimensiones - Dimensioni		cm	72x78x190
Door opening height - Altura puerta - Apertura porta		cm	85
Washing cycle - Ciclo de lavado - Ciclo di lavaggio		min.	2 - 4 - 8 - ∞
Rack - Cesta - Cesto		cm	56x63
Water consumption - Consumo de agua - Consumo acqua		L/cycle - L/ciclo - L/ciclo	4
Wash pump - Bomba propulsora - Pompa di lavaggio		kW	1.7
		L	37
Tank - Cuba - Vasca		kW	3
		°C	55
		L	7
Booster - Calderín - Boiler		kW	6
		°C	80
Tank strainer - Filtro cuba - Filtri vasca			✓



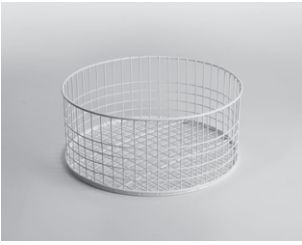
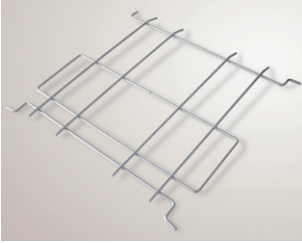

Optional	Cod.	€	Installed power Potencia instalada - Potenza Installata	Amp.	kW
Rinse dispenser Dosificador de abrillantador - Dosatore brillantante	41952	178,00	400 V - 50 Hz - 3N	16	7.7
Detergent dispenser Dosificador de detergente - Dosatore detergente	41953	178,00	Available -Disponibile - Disponibile		
			400 V - 60 Hz - 3N	16	7.7

**Rack
Cestas
Cesti**
35x35
39x39





	Mod.	Dim. (cm)	(cm)	Cod.	€
	Square flat rack for glasses Cesta cuadrada de varilla Cesto bicchieri quadrato fondo piano	35x35x15		983063	44,00
		39x39x10		983055	42,00
		39x39x15		983056	45,00
	Round rack Cesto redondo de varilla Cesto bicchieri rotondo	Ø 35 - h 11		706095	45,00
		Ø 35 - h 16.5		706107	51,00
		Ø 39 - h 11		983060	51,00
		Ø 39 - h 16.5		983015	51,00
	Round rack adapter Adaptador para cesta redonda Griglia supporto cesto tondo (EW530)	Ø 35		433030	26,00
	Round rack adapter Adaptador para cesta redonda Griglia supporto cesto tondo (EW540)	Ø 39		433031	26,00
	Square sloping rack 3 rows Cesta quadra con fondo inclinado 3 filas Cesto bicchieri quadrato 3 file fondo inclinato	39x39x17	Ø 11	983041	62,00

Rack Cestas Cesti

35x35
39x39



	Mod.	Dim. (cm)	(cm)	Cod.	€
	Square sloping rack 4 rows Cesta quadra con fondo inclinado 4 filas Cesto bicchieri quadrato 4 file fondo inclinato	39x39x17	Ø 8.5	983038	64,00
	Glass rack close mesh Cesta vasos Cesto bicchieri quadrato fondo piano	35x35x11		780138	40,00
		39x39x15		780133	53,00
	Sloping glass insert for rack 780135 Contenedor inclinador para cesta 780135 Inserto inclinado bicchieri per cesto 780135			780136	17,00
	Standard small dish insert Insertador para platos Inserto inclinado universale per piattini	30.5 x 9 x 7.5	n. 13	712020	17,00

**Rack
Cestas
Cesti**
45x45

	Mod.	Dim. (cm)	(cm)	Cod.	€
	Square dishes rack Cesta platos de varilla Cesto piatti quadrato	45x45	n. 14 - Ø 24	983067	64,00
	Square plat rack for glasses Cesta cuadrada de varilla Cesto bicchieri quadrato fondo piano	45x45x10		983068	63,00
	Glass rack Cesta vasos Cesto bicchieri	45x45x10.6		780128	53,00
	Dish rack Cesta platos Cesto piatti	45x45x10.6		780129	53,00



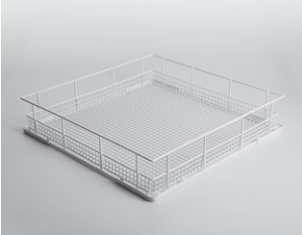

Rack Cestas Cesti

50x50

	Mod.	Dim. (cm)	(cm)	Cod.	€
	Square rack Cesta de varilla Cesto quadro	50x50x15		983032	64,00
	Square sloping rack 6 rows Cesta quadra con fondo inclinado 5 filas Cesto bicchieri quadrato 5 file fondo inclinato	50x50x17	n. 14 - Ø 24	983082	81,00
	Square dishes rack Cesta platos de varilla Cesto piatti quadrato	50x50	n. 18 - Ø 24 n. 8 - Ø 33	983027	60,00
	Square cutlery rack Cesta quadra para cubiertos Cesto posate quadrato	50x50		983033	89,00





Rack Cestas Cesti

50x50

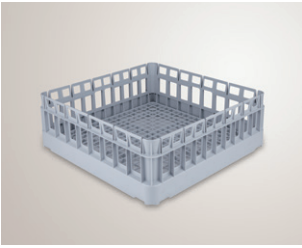
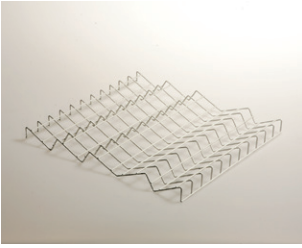

	Mod.	Dim. (cm)	(cm)	Cod.	€
	Flat rack close mesh Cesta vasos Cesto posate	50x50		780080	58,00
	Cesta para platos pizza Plate rack for pizza dishes Cesti piatti pizza	50x50	n. 9 - Ø 38	780074	65,00
	Tray rack Cesta para bandejas Cesto vassoi	50x50	n. 6 - 53x37	780106	67,00
	Tray rack Cesta para bandejas Cesto vassoi	50x50	n. 4 - 53x37	780077	130,00

Rack Cestas Cesti



50x50

	Mod.	Dim. (cm)	(cm)	Cod.	€
	Glass rack Cesta vasos Cesto bicchieri	50x50		780135	53,00
	Sloping cup insert for rack 780135 Parrilla insertador para tazas para cesta 780135 Inserto inclinatore tazze per cesto 780135			780082	33,00
	Sloping glass insert for rack 780135 Contenedor inclinador para cesta 780135 Inserto inclinato bicchieri per cesto 780135			780136	17,00
	Dish rack Cesta platos Cesto piatti	50x50	n. 18 - Ø 24	780072	55,00

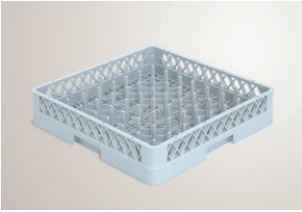
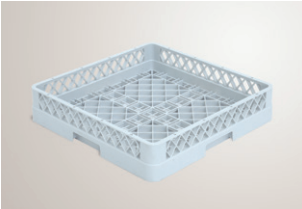



**Rack
Cestas
Cesti**

	Mod.	Dim. (cm)	(cm)	Cod.	€
	Cutlery insert Contenedor de cubiertos Cestello porta posate	11x11x14		780139	10,00
	4 division cutlery insert Contenedor de cubiertos de 4 compartimentos Inserto posate a 4 divisioni	21.7x21.7x13.4		780081	27,00
Not usable for rack conveyor-no utilizable en lavavajillas de arrastre-non utlizzabile nelle lavastovlie a traino					
	Dish rack Cesta platos Cesto piatti	50x50		780131	44,00
	Glass rack Cesta vasos Cesto bicchieri	50x50		780132	44,00

**Rack
Cestas
Cesti**
**Utensil-washer
Lava-utensilios
Lavapentole**

	Mod.	Dim. (cm)	(cm)	Cod.	€
	Inox rack Cesto acero Cesto inox EW3102 EW3103	56x63		41305	210,00
	Inox rack Cesto acero Cesto inox EW3104	70x70		42305	252,00
	Inox rack Cesto acero Cesto inox EW3105	131x70		43305	520,00





**Rack
Cestas
Cesti**

	Mod.	Dim. (cm)	(cm)	Cod.	€
	Inox insert for funnel and sac à poche Insertador en embudo para confitería Inserto inox per imbuti e sac à poche	Ø 17		706128	47,00
	Inox insert for 8 tray for tray 4 cm deep Soporte para 8 bandejas Profundidad máxima de la bandeja 4 cm Telaio inox per 8 teglie profondità max 4 cm	50x50		H.324660	150,00
	Inox insert for 5 tray for tray 6.5 cm deep Soporte para 5 bandejas Profundidad máxima de la bandeja 6.5 cm Inserto inox per 5 teglie profondità max 6.5 cm	50x50		712018	174,00
	Inox insert for cutlery and utensils Contenedor de cúbrertos Contentitore inox per posate ed utensili	15x15		712017	63,00

Detergents

Detergencia

Detergenza

	Mod.	Dim. (cm)	(cm)	Cod.	€
	PRO RINSE				
	Rinse-aid for soft water (5 liters can - box of 4 cans) Abillantador para el agua blanda (caja de 5 litros - 4 bidónes) Brillantante per acque dolci (scatola da 4 taniche - taniche da 5 l)			131320	103,00
	PRO RINSE H				
	Rinse-aid for hard water (5 liters can - box of 4 cans) Abillantador para el agua dura (caja de 5 litros - 4 bidónes) Brillantante per acque dure (scatola da 4 taniche - taniche da 5 l)			131321	122,00
	PRO WASH 1				
	Liquid detergent for soft water (6 liters can - box of 4 cans) Detergente líquido para el agua blanda (caja de 6 litros - 4 bidónes) Detersivo liquido per acque dolci (scatola da 4 taniche - taniche da 6 l)			131318	100,00
	PRO WASH 2				
	Liquid detergent for hard water (6 liters can - box of 4 cans) Detergente líquido para el agua dura (caja de 6 litros - 4 bidónes) Detersivo liquido per acque dure (scatola da 4 taniche - taniche da 6 l)			131316	122,00

GENERAL SALES CONDITIONS

All machines, accessories and ancillary equipment quoted in this price-list are subject to following sales conditions:

PRICES Ex-factory.

PAYMENTS As agreed.

PACKING Standard packing is included in the list price for all machines quoted.

SHIPMENT The manufacturer is not responsible for damage during the transport.

The consignee must check the good on arrival and contest any damage with the forwarding agent, who is responsible.

The good are the manufacturer's property until the corresponding payment has been made in full.

GUARANTEE 12 months.

SPECIAL VOLTAGE For voltage request differing from the usual electric standards, an extra charge of 5% shall be added to the basic price

(a minimum quantity to be order will be established when placing the order).

NO LIABILITY WHATSOEVER WILL BE ACCEPTED FOR SHIPMENT DELAYS DUE TO CAUSE OUTSIDE THE CONTROL OF AMIKA

CONDICIONES GENERALES DE VENTA

Las máquinas y los accesorios que figuran en la presente lista de precios están sujetas a las siguientes condiciones de venta:

PRECIOS Franco nuestros almacenes.

I.V.A. No incluido, a cargo del comprador.

PAGO Según condiciones acordadas.

EMBALAJE Standard incluido en el precio.

El fabricante no responde de los daños causados durante el transporte.

EXPEDICIÓN A la recepción de la mercancía por parte del destinatario, debe verificar que se encuentra en perfecto estado.

En caso de observar algún deterioro debe presentar la reclamación al transportista que es el responsable.

En el caso de que la mercancía viajara franco al destino, el destinatario es así mismo responsable de la mercancía.

GARANTÍA Contra cualquier defecto en su fabricación doce meses.

La garantía no cubre los daños causados en la máquina por una errónea conexión o manipulación.

VOLTAJES ESPECIALES Para máquinas que trabajen a voltajes y frecuencias diferentes a nuestros standard, el precio se verá incrementado en el 5%.

(pedido mínimo de máquinas, se determinará en cada caso).

LA EMPRESA NO ACEPTARÁ NINGÚN CARGO POR RETRASO EN EL SUMINISTRO DE LA MÁQUINA CUANDO SE TRATE DE UN CASO DE FUERZA MAYOR

CONDIZIONI GENERALI DI VENDITA

Le macchine e gli accessori di cui al presente listino sono soggetti alle seguenti condizioni di vendita:

PREZZI Franco nostro stabilimento.

I.V.A. A carico del committente.

PAGAMENTI Secondo le condizioni concordate.

IMBALLO Standard incluso nel prezzo. Il costruttore non risponde ai danni causati durante il trasporto.

SPEDIZIONE All'arrivo della merce il destinatario è tenuto al controllo e deve contestare eventuali danni al trasportatore che ne è responsabile.

Qualora, per accordi speciali, la spedizione avvenga franco destino, la merce viaggia comunque a rischio e pericolo del committente.

GARANZIA 12 mesi.

VOLTAGGI SPECIALI Per macchine a voltaggi diversi dagli allestimenti standard, supplemento del 5%

(lotto minimo di ordinazioni da definire all'atto dell'ordine).

NESSUN ADDEBITO VERRÀ ACCETTATO PER RITARDI DI CONSEGNA DOVUTI A CAUSE DI FORZA MAGGIORE

ITW Food Equipment Group

EUROTEC s.r.l.

Via Provinciale Romana, 6

55010 Badia Pozzeveri, LUCCA

Tel. +39 0583 2783 - Fax +39 0583 276506

www.amika.eurotecgrou.com - amika@itweurotec.it