

# TW52T

	Date	Name	 <small>THE INFORMATION CONTAINED IN THIS DRAWING IS THE SOLE PROPERTY OF CAVANOVA. ANY REPRODUCTION IN PART OR AS A WHOLE WITHOUT THE WRITTEN PERMISSION OF CAVANOVA IS PROHIBITED.</small>	
Design:	04/09/2019	Diego		
Checked:		Diego		
Modified:		Diego		
Notes:	Scale: 1:20	Part name: TW52T	Top assembly: TW52T	Client: Cavanova
		Description: Capacidad para 52 botellas		Material: Acero pintado
				Reference: TW52T
				Count: 1
				Pages: 1 OF 4

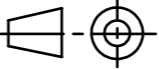

ALZADO

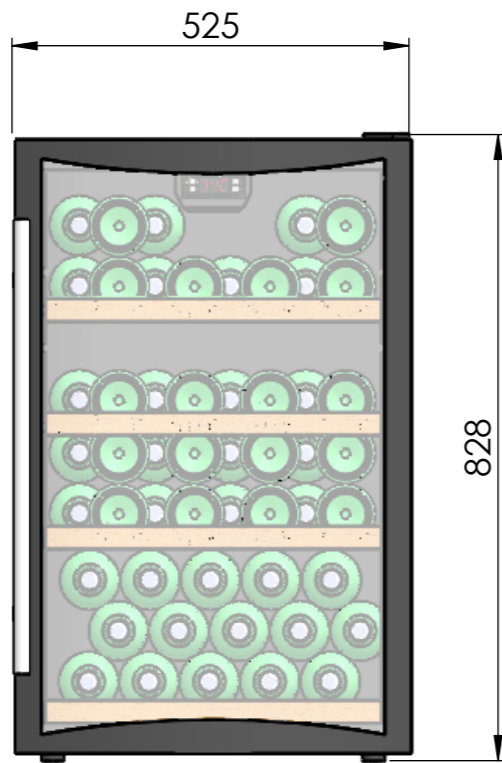
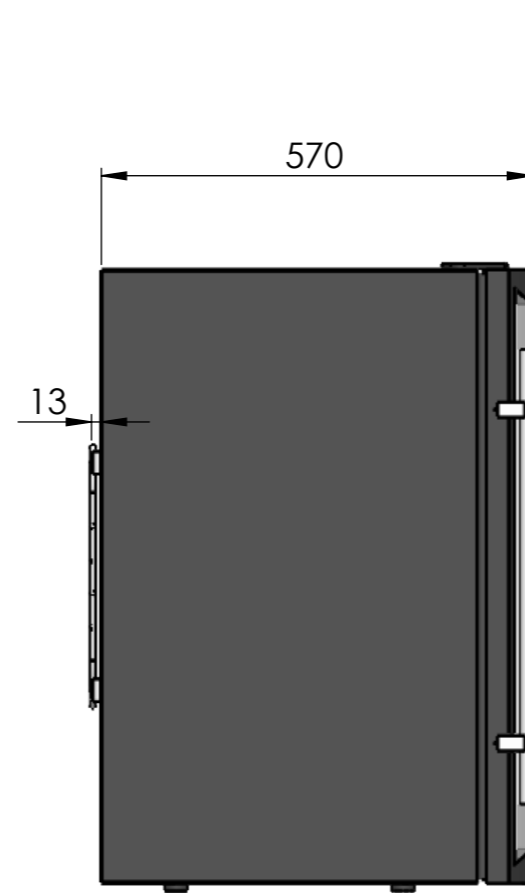

PERFIL

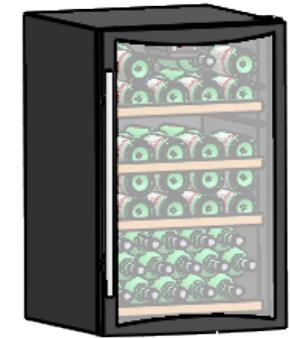

DATOS TÉCNICOS	
Volumen	133L
Peso	56kg
Botellas	52
Rango de temperatura	4-18°C
Frecuencia	50-60hz
Consumo	198Kwh/año
Voltaje	220/240V
Ruido	43db
Refrigerante	R600a
Humedad interior	>70%RH
Sistema de frío	Compresor

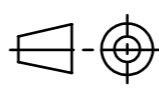
Date	Name	 <small>THE INFORMATION CONTAINED IN THIS DRAWING IS THE SOLE PROPERTY OF CAVANOVA WINE S.L. IN MÁLAGA, SPAIN. ANY REPRODUCTION IN PART OR AS A WHOLE WITHOUT THE WRITTEN PERMISSION OF CAVANOVA WINE S.L. IS PROHIBITED.</small>	
Design:	10/12/2018 Diego		
Checked:	Diego		
Modified:	Diego		
Scale: 1:20	Part name: TW52T	Top assembly: TW52T	Client: Cavanova
Unit: mm			Material: Acero pintado
	Description:		Reference: TW52T
	Capacidad para 52 botellas		Count:
			Pages: 2 OF 4

Sign:

4 baldas de madera

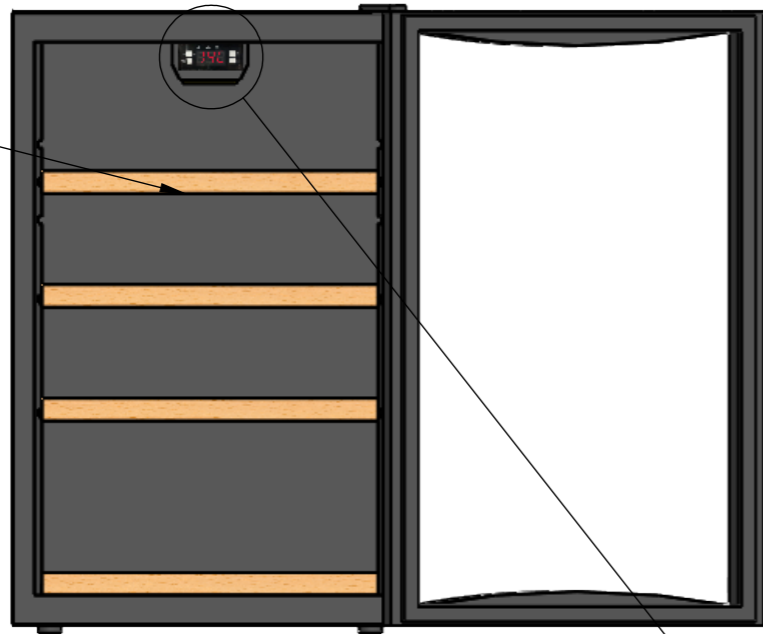

ALZADO

condensador

Compresor

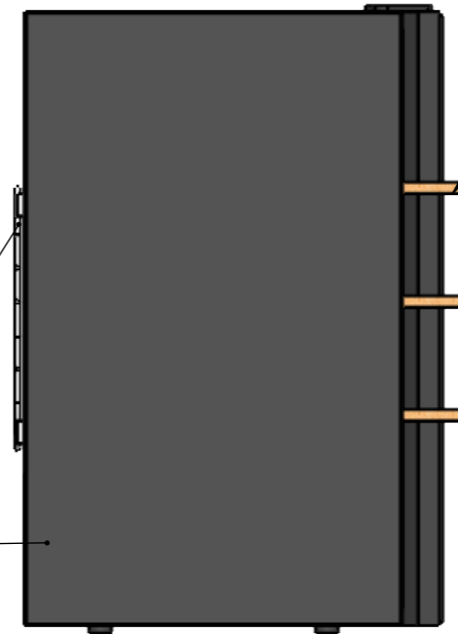

PERFIL

Baldas extraíbles

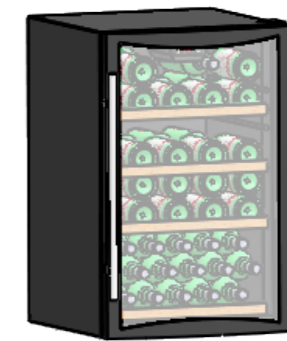

Control de temperatura

Luz

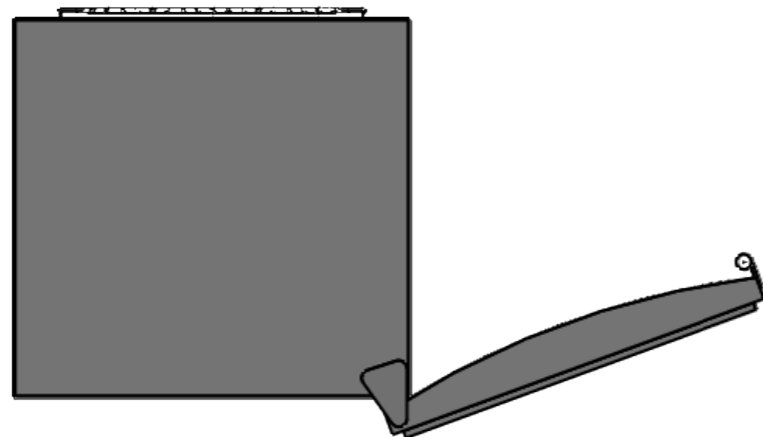
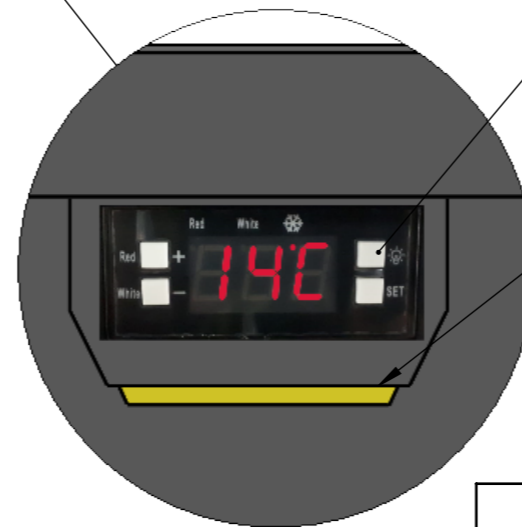

PLANTA

DATOS TÉCNICOS

Volumen	230L
Peso	56kg
Botellas	80
Rango de temperatura	4-18°C
Frecuencia	50-60hz
Consumo	230Kwh/año
Voltaje	220/240V
Ruido	43db
Refrigerante	R600a
Humedad interior	>70%RH
Sistema de frío	Compresor

	Date	Name
Design:	04/09/2019	Diego
Checked:		Diego
Modified:		Diego

**cavanova**

THE INFORMATION CONTAINED IN THIS DRAWING IS THE SOLE PROPERTY OF CAVANOVA WINE S.L. IN MÁLAGA, SPAIN. ANY REPRODUCTION IN PART OR AS A WHOLE WITHOUT THE WRITTEN PERMISSION OF CAVANOVA WINE S.L. IS PROHIBITED.

Sign:

Scale: 1:20  
Unit: mm

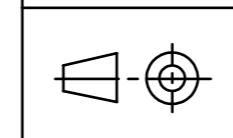

Part name: TW52T

Description: Capacidad para 52 botellas

Top assembly: TW52T

Client: Cavanova  
Material: Acero pintado  
Reference: TW52T  
Count:  
Pages: 3 OF 4

Medidas recomendadas	
Altura	878mm
Anchura	50mm por cada lado
Profundidad	100mm de espacio

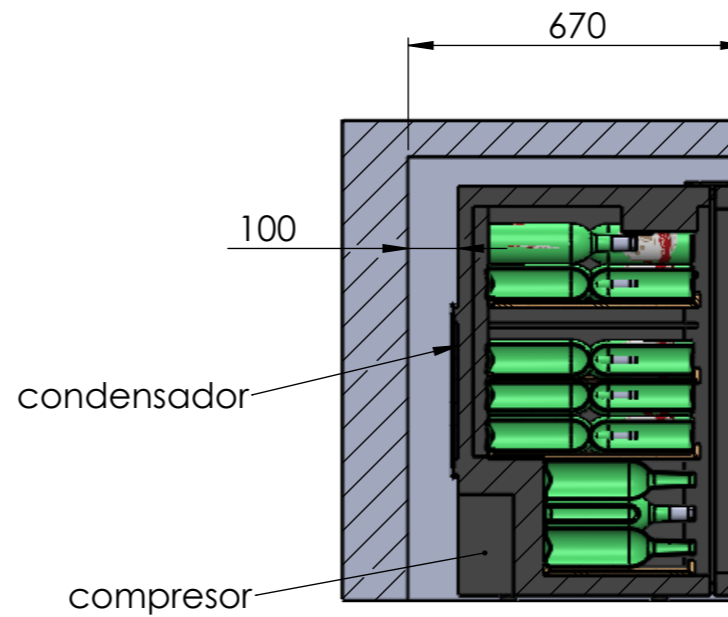
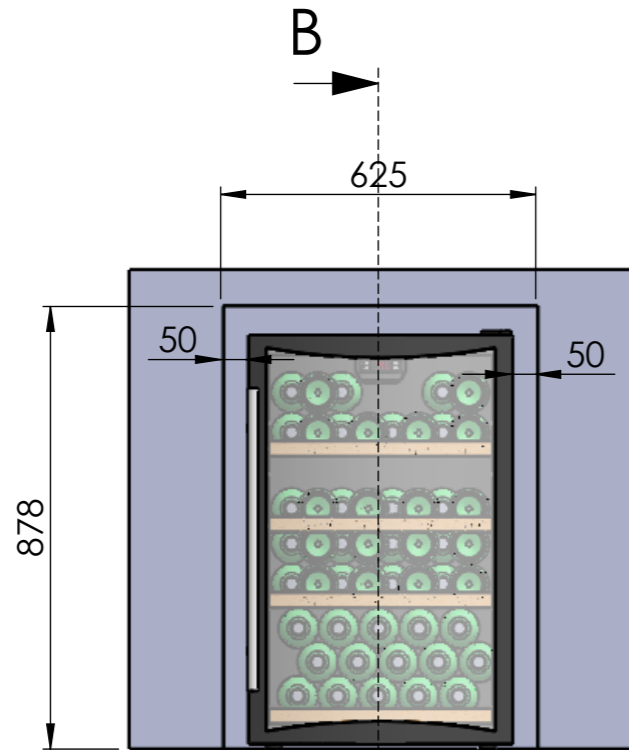

SECCIÓN B-B

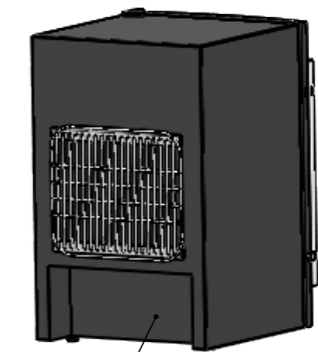

Compresor (correcta ventilación)

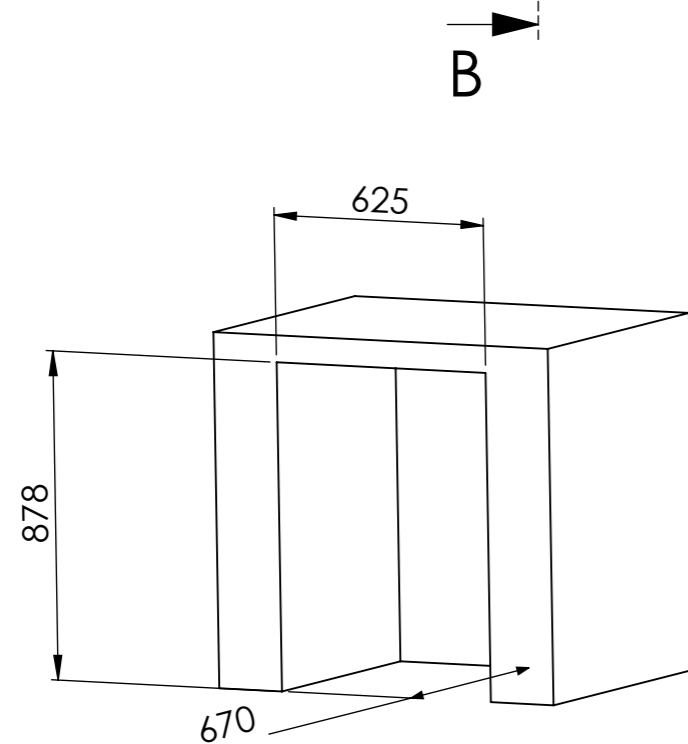

Hueco para vinoteca

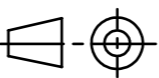
	Date	Name	 <small>THE INFORMATION CONTAINED IN THIS DRAWING IS THE SOLE PROPERTY OF CAVANOVA WINE S.L. IN MÁLAGA, SPAIN. ANY REPRODUCTION IN PART OR AS A WHOLE WITHOUT THE WRITTEN PERMISSION OF CAVANOVA WINE S.L. IS PROHIBITED.</small>	
Design:	03/09/2019	Diego		
Checked:		Diego		
Modified:		Diego		
Sign:	Scale: 1:20	Part name: TW52T-ENTORNO	Top assembly: TW52T	Client: Cavanova
	Unit: mm			Material: Varios
	Description: Empotramiento del equipo (built-in)			Reference: TW52T-ENTORNO
				Count:
				Pages: 4 OF 4