



## Index

---

Notes.....	2
Pre-installation .....	3
Maintenance openings .....	5
Data sheets for bathtubs and whirltubs .....	9

## Notes

---

### PLANNING

Before starting the installation, plan the layout in detail, taking the site conditions into consideration.

### TARGET READERSHIP AND QUALIFICATIONS

All work associated with the installation and water connection may only be undertaken by a plumber and all work associated with the electrical installation may only be undertaken by a licensed electrician.

### SAFETY INSTRUCTIONS

#### **Incorrect handling/transport may result in product damage.**

The metal frame and whirl system are not resilient.

- > Never hold by the metal frame or whirl system.

Improper transport can cause damage to the product and/or property damage, e.g. leaks.

- > Wear appropriate protective clothing.
- > Avoid knocks.

#### **Risk of product and/or property damage!**

The breach of local and country-specific regulations and standards can cause damage to the product and/or property damage.

- > Observe the local installation regulations and any country-specific standards at all times.

Duravit AG assumes no liability for the consequences of improper handling or improper transport.

## Pre-installation

### INSTALLATION LOCATION / INSTALLATION ROOM

> Make sure that the installation location fulfils the following criteria

<b>Doors / external access</b>	<ul style="list-style-type: none"> <li>Ensure that doors or other access openings are large enough to accommodate transport dimensions, keeping in mind the weight and need for sufficient manoeuvring room.</li> </ul>
<b>Required area</b>	<ul style="list-style-type: none"> <li>Allow for enough space around the tub for the installation.</li> </ul>
<b>Floor</b>	<ul style="list-style-type: none"> <li>Completely level.</li> <li>At a right angle to the wall.</li> <li>Note the overall strength of the floor structure including the floor finish.</li> <li>There must not be any underfloor heating under the tub.</li> <li>Install tubs <b>after</b> the tiles. (Top edge of finished floor).</li> <li>Depending on the combination of tub and whirl system it is possible that system components may protrude beyond the edge of the tub. We therefore recommend installation in a support frame.</li> <li><b>Tolerances for acrylic:</b> As a result of the manufacturing process, deviations from the nominal dimensions may occur within the limits specified in the DIN 198 standard. Please take this into account in your planning.</li> </ul>
<b>Wall</b>	<ul style="list-style-type: none"> <li>Tiled.</li> <li>At a right angle to the tub.</li> <li>Completely straight.</li> <li>Note the overall strength of the wall structure including the wall finish.</li> </ul>

### WATER INSTALLATION

#### NOTE

A pipe interrupter is absolutely essential for tubs with a base inlet (DIN EN 1717).

> Comply with assembly scheme.

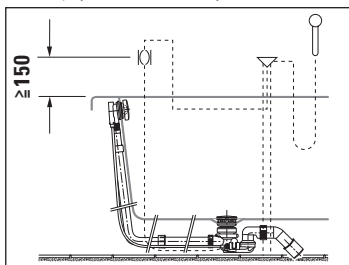

#### Water connection

- Connections for the water supply and drains must be in compliance with the currently valid standards and public regulations.
- Position the water drain (DN 50) flush to the mounting surface or out of

the wall directly above the mounting surface; see drawing for recommended area.

### MAINTENANCE OPENINGS AND AIR SUPPLY

#### NOTE

It is recommended to install the tub with a removable bathtub panel due to the improved maintenance options.

#### Tiling the tub

The following maintenance openings must be provided:

- Cable-driven waste and overflow 200 x 200 mm
- Units 500 x 500 mm  
(Please see the section on "Maintenance openings")
- Control unit for coloured LED light 200 x 200 mm  
(Maintenance opening at the foot end)
- Provide an opening in the panel for the air supply with an effective area of approx. 15cm<sup>2</sup> (e.g. 3 x 5 cm or 2 x 7.5 cm).

#### Tub with a panel

- The panel must be removed for maintenance, and with a seamless panel, the tub must be removed from the wall. Your plans should therefore include a clearance in front of the tub.
- The air supply for the whirl system (ventilation grille/ventilation slot) must not be covered.

### ELECTRICAL INSTALLATION



**DANGER**

**Risk of fatal electric shock**

- Disconnect the power supply while working on the electrical components.
- The device must be earthed. Earthed appliances must be permanently connected to fixed wiring.
- Connect the device only to the designated electrical cable.
- NEVER touch the power supply line with wet hands.

#### Pre-installation

- Lay a permanent power supply line which must be on a separate circuit.
  - The device itself does not have electrical leakage protection function. The device must be supplied through a residual current device (RCD) with a rated residual operating current not exceeding 30 mA.
  - Means for disconnection must be incorporated in the fixed wiring in accordance with the wiring rules and have a contact separation in all poles that provides full disconnection under overvoltage category III conditions outside the prescribed protection zones (0 – 2).
    - Leave 3000 mm of the supply line exposed.
- Lay an equipotential bonding cable:
  - Leave 3000 mm of cable exposed.
- Select a supply line cross-section based on the connected load on the identification plate (2.5 mm – 4 mm).
- Confirm that the grounding wire is 10 mm (3/8") longer than the L and N wire.
- Install a circuit breaker.

## PROTECTION ZONES

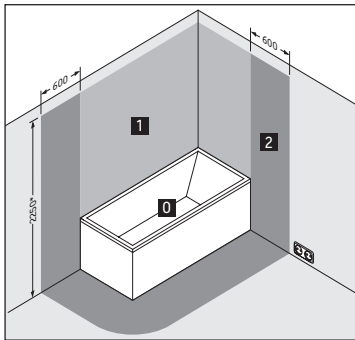

\* Or the height of the highest fixed-location shower head/water outlet, whichever is higher.

Combi-System L (# 760XXX XX X CL 10XX)	1.59 kW	2.64 kW
Jet System E (# 760XXX XX X JE 10XX)	1.14 kW	2.20 kW

### Power supply

# 76XXXX XX X XX XXX0: 220 – 240 V AC, 50 Hz

# 76XXXX XX X XX XXX6: 220 – 240 V AC, 60 Hz

**Fuse**  $I_N = 16 \text{ A}$

**RCD**  $I_{\Delta N} \leq 30 \text{ mA}$

## COLOURED LED LIGHT/WHITE LED LIGHT UNDER THE EDGE OF THE TUB FOR BATHTUBS

### Electrical data

#### Power supply

Coloured LED light with remote control for bathtubs #790840 00 0 00 xx00	110 – 240 V AC, 50/60 Hz, 30 W
Coloured LED light with remote control for Blue Moon bathtub #790846 00 0 00 xx00	110 – 240 V AC, 50/60 Hz, 60 W
White LED light under the edge of the tub #791847 00 0 00 0000 #791848 00 0 00 0000 #791849 00 0 00 0000	220 – 240 V AC, 50/60 Hz, 50 W

**Fuse**  $I_N = 16 \text{ A}$

**RCD**  $I_{\Delta N} \leq 30 \text{ mA}$

## WHIRLTUBS

### Electrical data

Whirl system	Rated power with standard equipment	Max. rated power, fully-equipped
Air System (# 760XXX XX X AS 00XX)	0.76 kW	0.85 kW
Air System (DuraSolid) (# 760XXX XX X AS 00XX)	0.58 kW	0.58 kW
Jet Project (# 760XXX XX X JP 10XX)	0.66 kW	0.66 kW
Jet System (# 760XXX XX X JS 10XX)	0.59 kW	0.67 kW
Combi-System P (# 760XXX XX X CP 10XX)	1.89 kW	1.98 kW
Combi-System E (# 760XXX XX X CE 10XX)	1.91 kW	2.96 kW

## Maintenance openings

### Maintenance

Install the whirltub in such a way that all of the important equipment (pump, blower and control system) remains accessible. It is recommended to install the tub with a removable furniture panel for easy maintenance.

### Location of the whirl system components

The illustrations show the standard configuration for the components of the whirl system\* with the location of the operating unit. The back massage is located at the head end (depending on the whirl system).

Custom-made designs available on request. In such cases we will require a drawing showing the desired layout. Duravit will confirm whether the desired layout can be implemented.

### Blue Moon

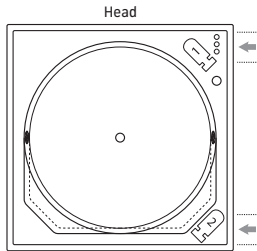

# 760143

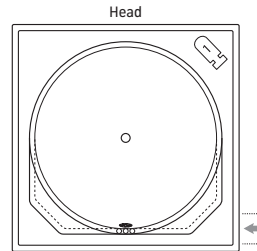

# 760402

### Cape Cod

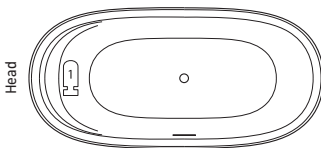

# 760330

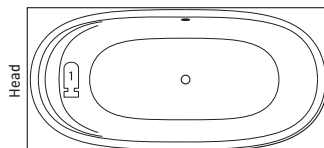

# 760362

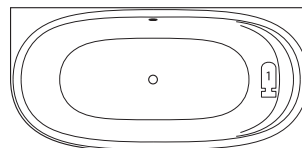

# 760363

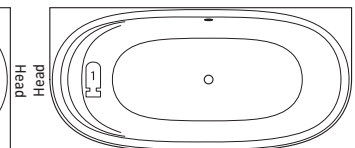

# 760364

### Darling New

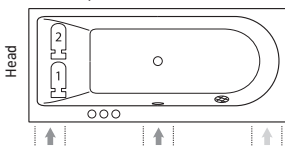

# 760242

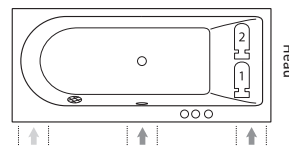

# 760243

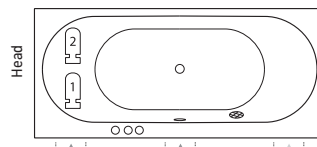

# 760244, # 760245

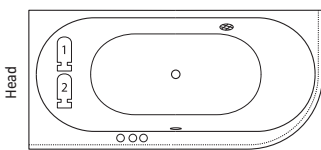

# 760246

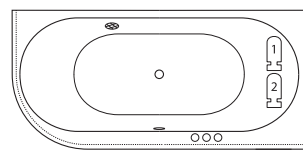

# 760247

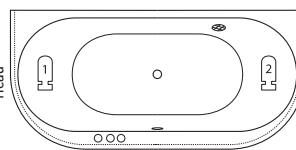

# 760248

### D-Code

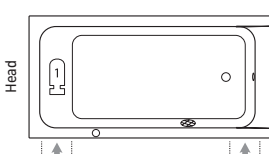

# 760095, # 760096,  
# 760098, # 760100

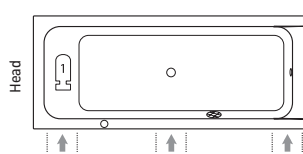

# 760097, # 760099

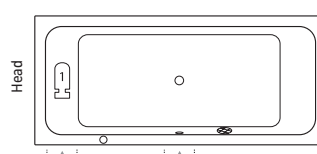

# 760101

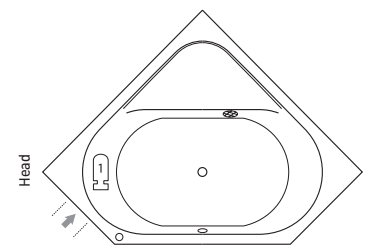

# 760137

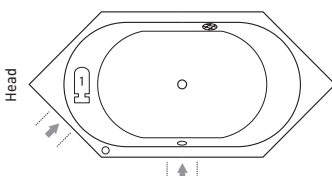

# 760138

\* Please note that depending on the combination of tub and whirl system it is possible that system components may protrude beyond the edge of the tub. We therefore recommend installation in a support frame

**DuraSquare**

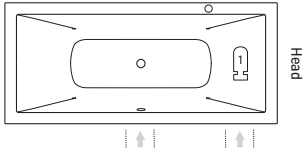

# 760426

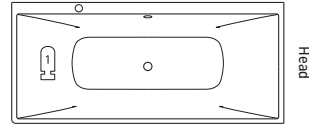

# 760427

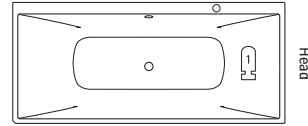

# 760428, # 760429

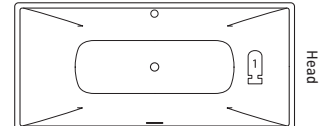

# 760430

**DuraStyle**

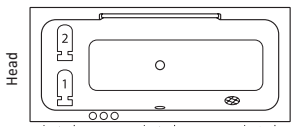

# 760292, # 760294, # 760296

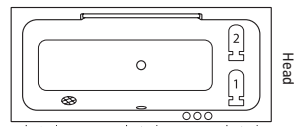

# 760293, # 760295, # 760297

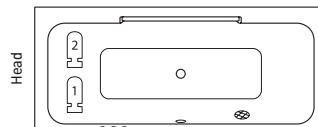

# 760298, # 760299

**Happy D.2**

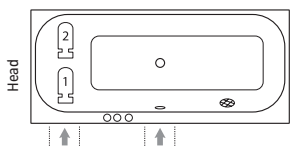

# 760308, # 760310, # 760312

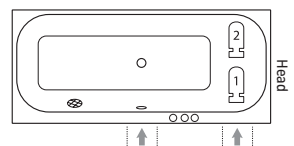

# 760309, # 760311, # 760313

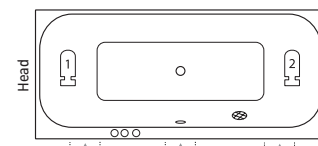

# 760314, # 760315

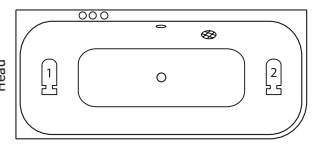

# 760316

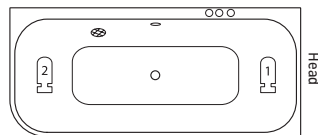

# 760317

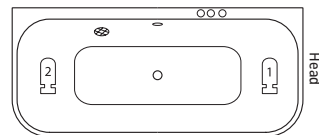

# 760318

**Happy D.2 Plus**

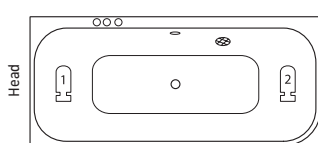

# 760449

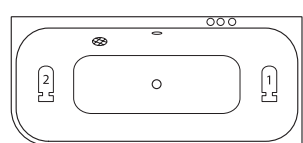

# 760450

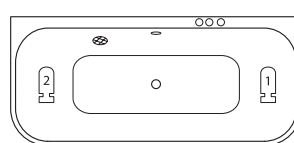

# 760451

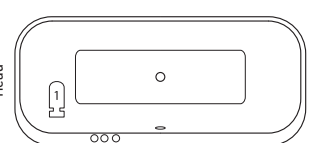

# 760453

**Luv**

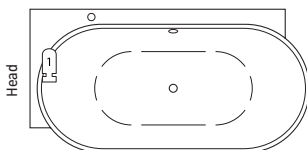

# 760431

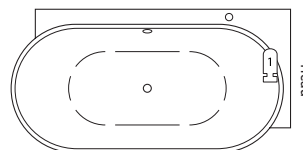

# 760432

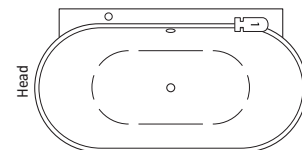

# 760433

### P3 Comforts

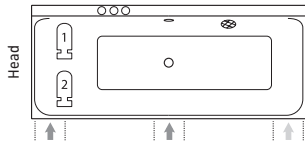

# 760371, # 760373, # 760375

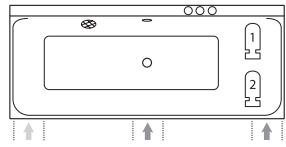

# 760372, # 760374, # 760376

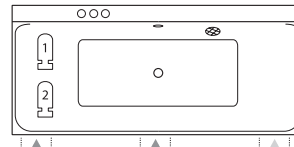

# 760377, # 760378

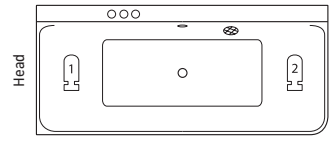

# 760379

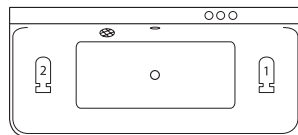

# 760380

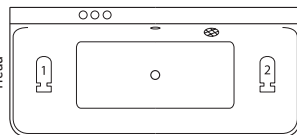

# 760381

### Paiova

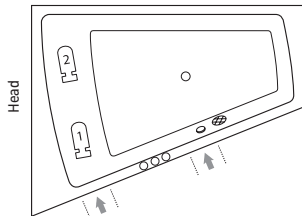

# 760212, # 760214, # 760216

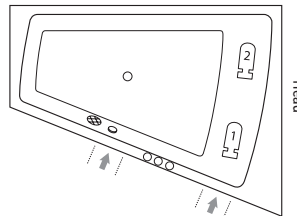

# 760213, # 760215, # 760217

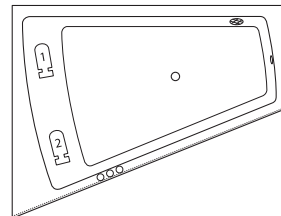

# 760264, # 760266, # 760268

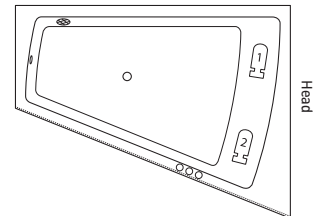

# 760265, # 760267, # 760269

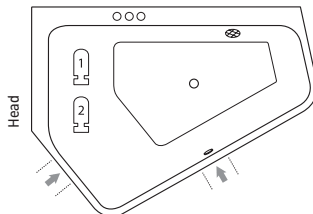

# 760390, # 760392

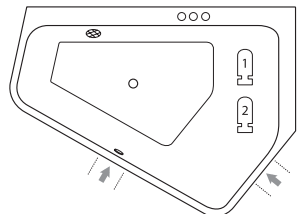

# 760391, # 760393

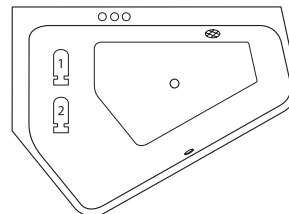

# 760394, # 760396

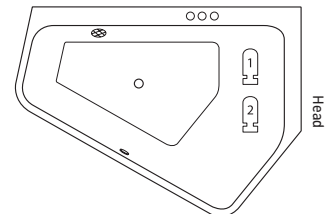

# 760395, # 760397

### Starck

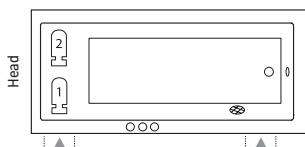

# 760050, # 760331, # 760332,  
# 760333, # 760334, # 760335,  
# 760336, # 760337

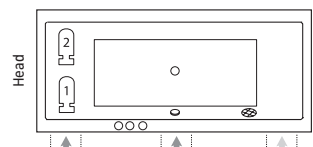

# 760052, # 760338, # 760339,  
# 760340, # 760341

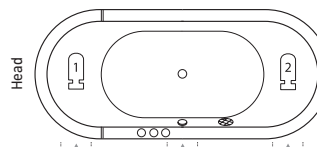

# 760009

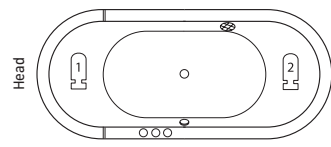

# 760010

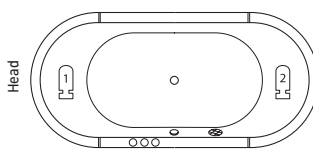

# 760011

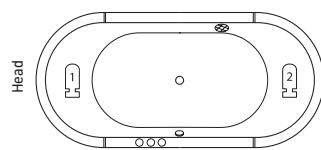

# 760012

### Vero Air

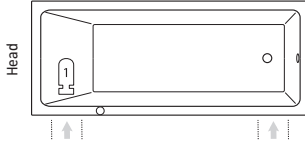

# 760411, # 760412

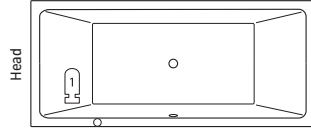

# 760413, # 760414

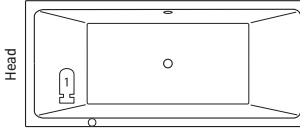

# 760415, # 760416, # 760417,  
# 760418

### Vero

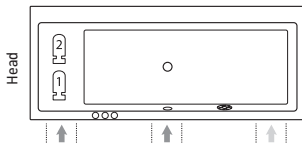

# 760133

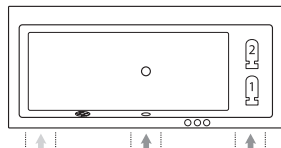

# 760134

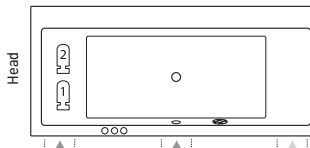

# 760135, # 760136

### Legend



Unit 1



Unit 2\*



Control panel\*\*



Suction  
screen



Pull  
button



Tap module



Recommended  
equipment covers



Recommended  
equipment covers\*\*\*

\* Only Combi-Systems / \*\* The number of operating elements is based on the whirl system and the additional modules selected / \*\*\* Only necessary for Combi-System E/L in combination with sound and/or coloured LED light



## Data sheets for bathtubs and whirltubs

---

# Pre-installation Starck # 700009/760009

1800 x 800 x 460

Design by Philippe Starck

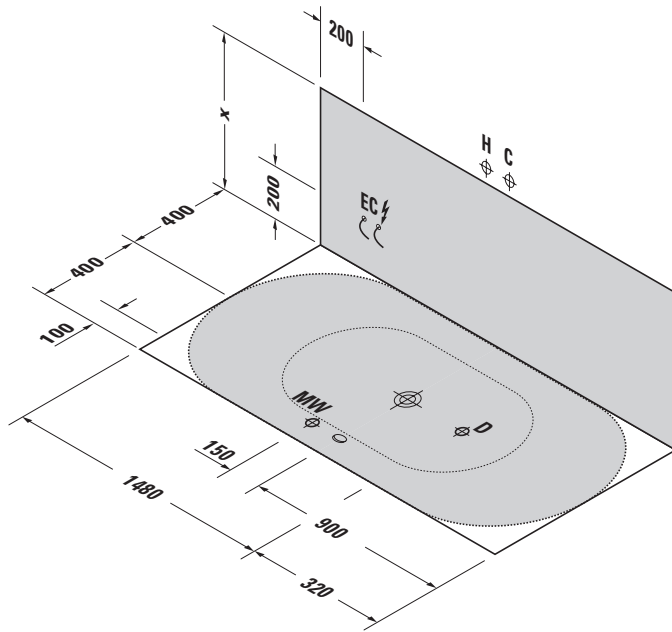

- H Hot water connection
- C Cold water connection
- D Drain connection
- MW Mixed water connection for outlet and overflow fittings with inlet function
- EC Electricity connection

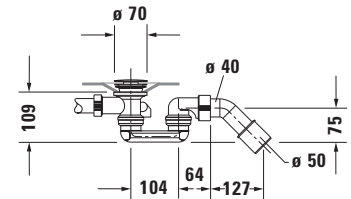

Siphon for bathtub # 700009

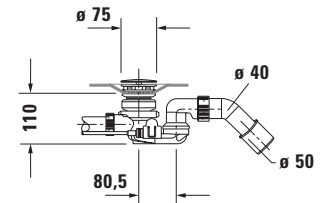

Siphon with base inlet for bathtub #700009

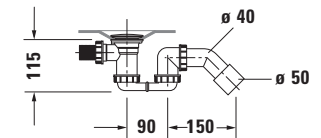

Siphon for whirltub # 760009

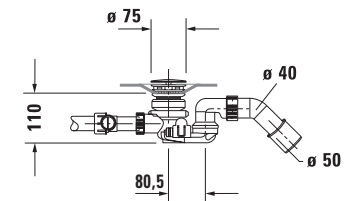

Siphon with base inlet for whirltub #760009

	Height	including feet	including support	including panel	including acrylic panel
X Bathtub	520	640 - 760	~ 600	-	-
X Whirltub	-	640 - 675	-	-	-

## Technical specifications

Net weight kg	Floor load kg/m <sup>2</sup>	Shipping weight kg	Shipping dimensions l x w x h (cm)	Water inlet OD, ID	Whirlsystem	Model-No.
26,0	178	41,0	120 x 80 x 195	3/4", 1/2"		700009 00 0 00 0000
37,0	185	79,0	202 x 105 x 86	3/4", 1/2"	Air-System	760009 00 0 AS 0000
41,0	188	83,0	202 x 105 x 86	3/4", 1/2"	Jet-System	760009 00 0 JS 1000
46,0	192	84,0	202 x 105 x 86	3/4", 1/2"	Combi-System P	760009 00 0 CP 1000
59,0 - 66,0	201 - 206	101,0 - 108,0	202 x 105 x 86	3/4", 1/2"	Combi-System E	760009 00 0 CE 1000
66,0 - 73,0	206 - 210	108,0 - 115,0	202 x 105 x 86	3/4", 1/2"	Combi-System L	760009 00 0 CL 1000

# Pre-installation Starck # 700010/760010

↳ 1800 x 800 x 460 ‹

Design by Philippe Starck

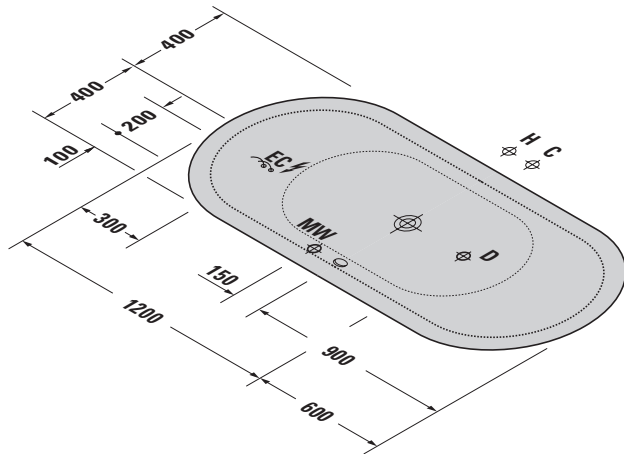

- H** Hot water connection
- C** Cold water connection
- D** Drain connection
- MW** Mixed water connection for outlet and overflow fittings with inlet function
- EC** Electricity connection

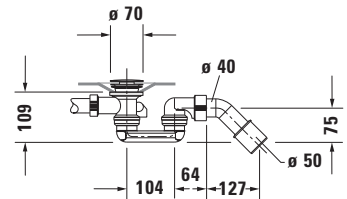

Siphon for bathtub # 700010

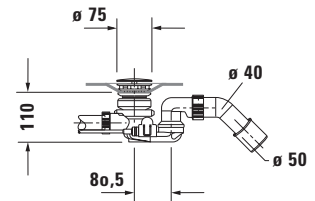

Siphon with base inlet for bathtub #700010

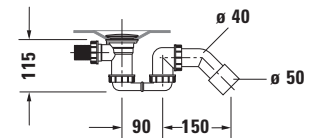

Siphon for whirltub # 760010

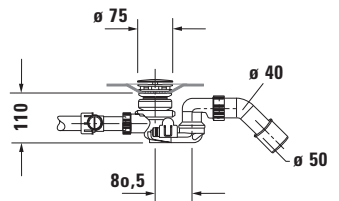

Siphon with base inlet for whirltub #760010

## Technical specifications

Net weight kg	Floor load kg/m <sup>2</sup>	Shipping weight kg	Shipping dimensions l x w x h (cm)	Water inlet OD, ID	Whirlsystem	Model-No.
58,0	200	73,0	187 x 213 x 87	3/4", 1/2"		700010 00 0 00 0000
65,0	205	107,0	202 x 105 x 86	3/4"	Air-System	760010 00 0 AS 0000
68,0	207	110,0	202 x 105 x 86	3/4"	Jet-System	760010 00 0 JS 1000
74,0	211	116,0	202 x 105 x 86	3/4"	Combi-System P	760010 00 0 CP 1000
87,0 - 94,0	220 - 225	129,0 - 136,0	202 x 105 x 86	3/4"	Combi-System E	760010 00 0 CE 1000
94,0 - 101,0	225 - 230	136,0 - 143,0	202 x 105 x 86	3/4"	Combi-System L	760010 00 0 CL 1000

# Pre-installation Starck # 700011/760011

↳ 1900 x 900 x 460 ‹

Design by Philippe Starck

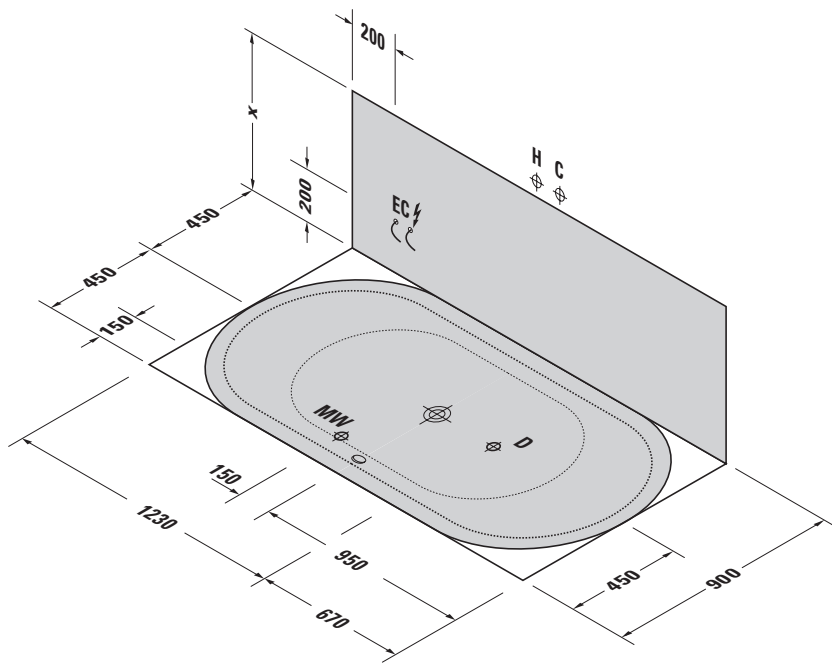

- H Hot water connection
- C Cold water connection
- D Drain connection
- MW Mixed water connection for outlet and overflow fittings with inlet function
- EC Electricity connection

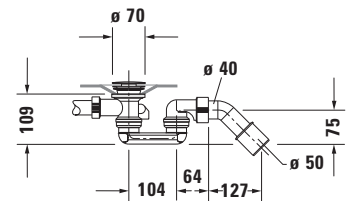

Siphon for bathtub # 700011

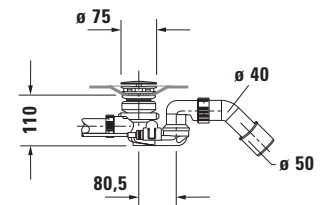

Siphon with base inlet for bathtub # 700011

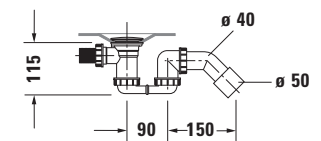

Siphon for whirltub # 760011

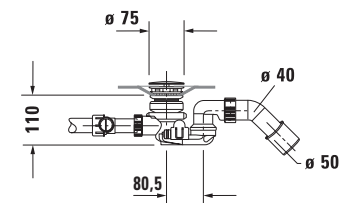

Siphon with base inlet for whirltub # 760011

	Height	including feet	including support	including panel	including acrylic panel
X Bathtub	520	640 - 760	~ 590	-	-
X Whirltub	-	640 - 660	-	-	-

## Technical specifications

Net weight kg	Floor load kg/m <sup>2</sup>	Shipping weight kg	Shipping dimensions l x w x h (cm)	Water inlet OD, ID	Whirlsystem	Model-No.
32,0	185	47,0	120 x 80 x 205	3/4", 1/2"		700011 00 0 00 0000
43,0	192	85,0	202 x 105 x 86	3/4", 1/2"	Air-System	760011 00 0 AS 0000
47,0	194	89,0	202 x 105 x 86	3/4", 1/2"	Jet-System	760011 00 0 JS 1000
52,0	197	94,0	202 x 105 x 86	3/4", 1/2"	Combi-System P	760011 00 0 CP 1000
65,0 - 72,0	205 - 211	107,0 - 114,0	202 x 105 x 86	3/4", 1/2"	Combi-System E	760011 00 0 CE 1000
72,0 - 79,0	211 - 213	114,0 - 121,0	202 x 105 x 86	3/4", 1/2"	Combi-System L	760011 00 0 CL 1000

## Pre-installation Starck # 700012/760012

↳ 1900 x 900 x 460 ‹

Design by Philippe Starck

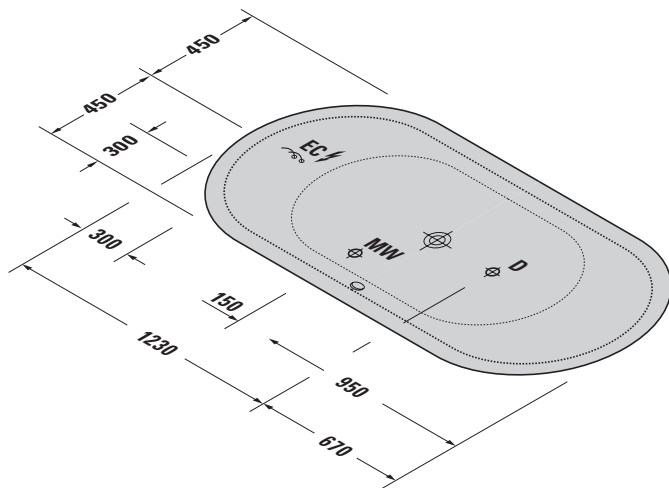

- H Hot water connection
- C Cold water connection
- D Drain connection
- MW Mixed water connection for outlet and overflow fittings with inlet function
- EC ⚡ Electricity connection

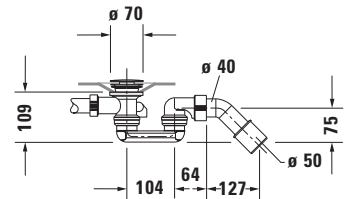

Siphon for bathtub # 700012

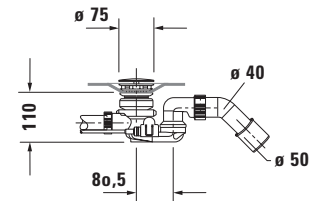

Siphon with base inlet for bathtub #700012

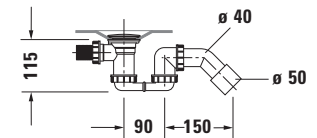

Siphon for whirltub # 760012

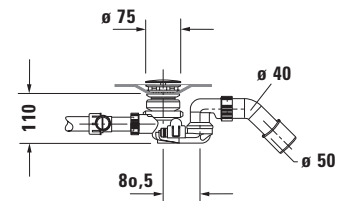

Siphon with base inlet for whirltub #760012

### Technical specifications

Net weight kg	Floor load kg/m <sup>2</sup>	Shipping weight kg	Shipping dimensions l x w x h (cm)	Water inlet OD, ID	Whirlsystem	Model-No.
72,0	212	87,0	197 x 213 x 87	3/4", 1/2"		700012 00 0 00 0000
79,0	213	121,0	202 x 105 x 86	3/4", 1/2"	Air-System	760012 00 0 AS 0000
82,0	215	124,0	202 x 105 x 86	3/4", 1/2"	Jet-System	760012 00 0 JS 1000
88,0	218	130,0	202 x 105 x 86	3/4", 1/2"	Combi-System P	760012 00 0 CP 1000
101,0 - 108,0	226 - 230	143,0 - 150,0	202 x 105 x 86	3/4", 1/2"	Combi-System E	760012 00 0 CE 1000
108,0 - 115,0	230 - 234	150,0 - 157,0	202 x 105 x 86	3/4", 1/2"	Combi-System L	760012 00 0 CL 1000

# Pre-installation Starck # 700409

↳ 1600 x 800 x 460 ‹

Design by Philippe Starck

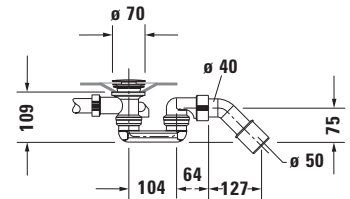
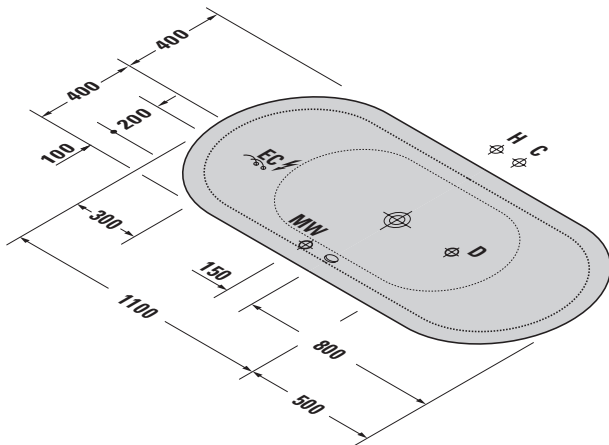

Siphon for bathtub # 700409

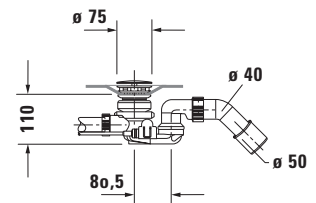

Siphon with base inlet for bathtub #700409

- H Hot water connection
- C Cold water connection
- D Drain connection
- MW Mixed water connection for outlet and overflow fittings with inlet function
- EC ⚡ Electricity connection

### Technical specifications

Net weight	Floor load	Shipping weight	Shipping dimensions	Water inlet	Whirlsystem	Model-No.
kg	kg/m <sup>2</sup>	kg	l x w x h (cm)	OD, ID		
46,0	250	61,0	168 x 222 x 88	3/4", 1/2"		700409 · 0 00 0000

# Pre-installation Starck # 700048

↳ 1800 x 900 x 460 ‹

Design by Philippe Starck

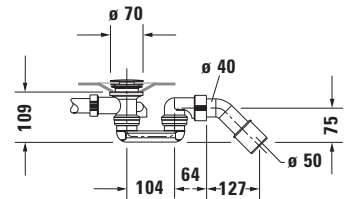
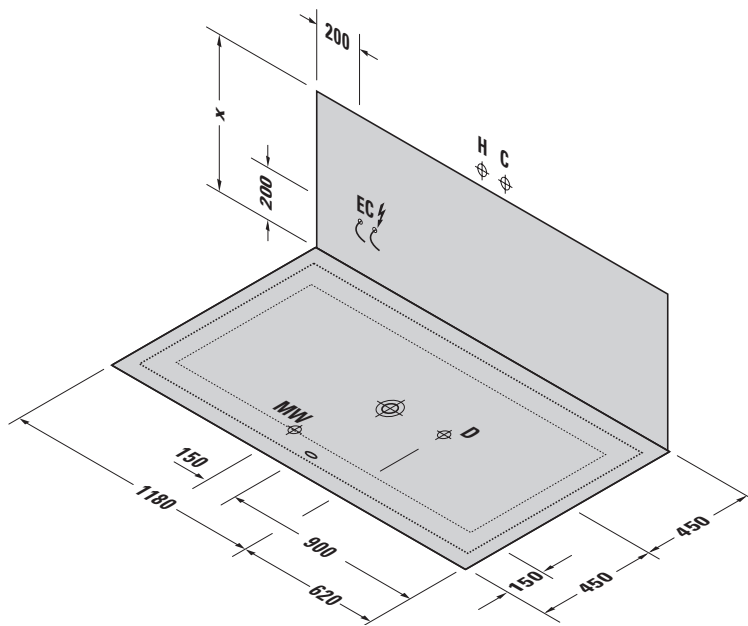

Siphon for bathtub # 700048

- H Hot water connection
- C Cold water connection
- D Drain connection
- MW Mixed water connection for outlet and overflow fittings with inlet function
- EC ⚡ Electricity connection

	Height	including feet	including support	including panel	including acrylic panel
X Bathtub	485	605 - 675	~ 590	-	-

### Technical specifications

Net weight	Floor load	Shipping weight	Shipping dimensions	Water inlet	Whirlsystem	Model-No.
kg	kg/m <sup>2</sup>	kg	l x w x h (cm)	OD, ID		
45,5	285	60,5	120 x 80 x 195	3/4", 1/2"		700048 · 0 00 0000

# Pre-installation Starck # 700050/760050

↳ 1800 x 900 x 460 ‹

Design by Philippe Starck

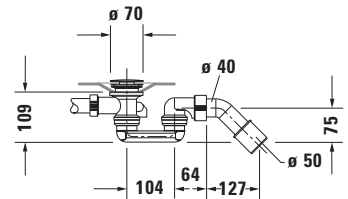
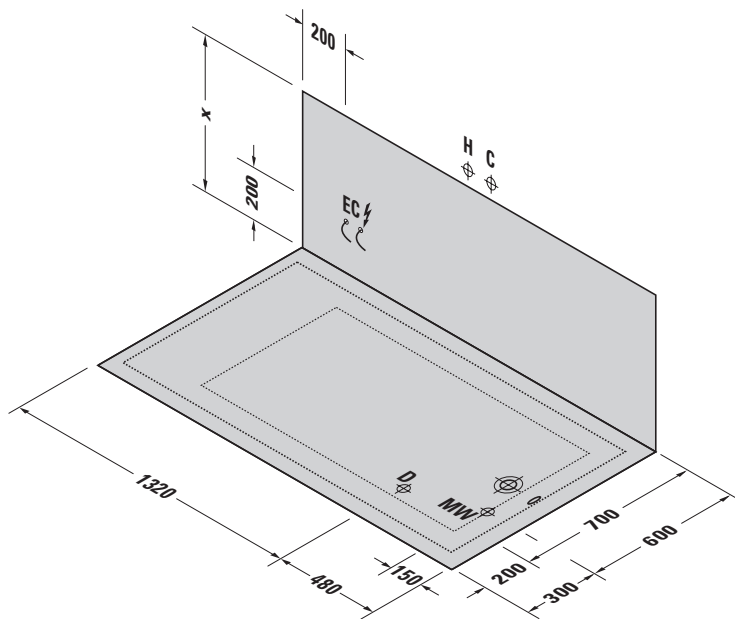

Siphon for bathtub # 700050

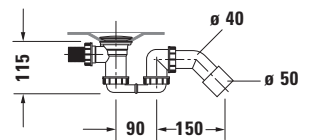

Siphon for whirltub # 760050

- H Hot water connection
- C Cold water connection
- D Drain connection
- MW Mixed water connection for outlet and overflow fittings with inlet function
- EC Electricity connection

	Height	including feet	including support	including panel	including acrylic panel
X Bathtub	485	605 - 675	~ 590	-	-
X Whirltub	-	605 - 640	-	-	-

## Technical specifications

Net weight kg	Floor load kg/m <sup>2</sup>	Shipping weight kg	Shipping dimensions l x w x h (cm)	Water inlet OD, ID	Whirlsystem	Model-No.
43,0	249	58,0	120 x 80 x 195	3/4", 1/2"		700050 00 0 00 0000
54,0	256	96,0	202 x 105 x 86	3/4"	Air-System	760050 00 0 AS 0000
58,0	259	100,0	202 x 105 x 86	3/4"	Jet-System	760050 00 0 JS 1000
63,0	262	105,0	202 x 105 x 86	3/4"	Combi-System P	760050 00 0 CP 1000
76,0 - 83,0	270 - 274	118,0 - 125,0	202 x 105 x 86	3/4"	Combi-System E	760050 00 0 CE 1000
83,0 - 90,0	274 - 278	125,0 - 132,0	202 x 105 x 86	3/4"	Combi-System L	760050 00 0 CL 1000



# Pre-installation Starck # 700052/760052

↳ 1800 x 900 x 460 ‹

Design by Philippe Starck

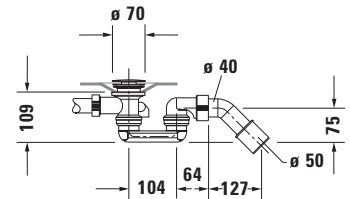
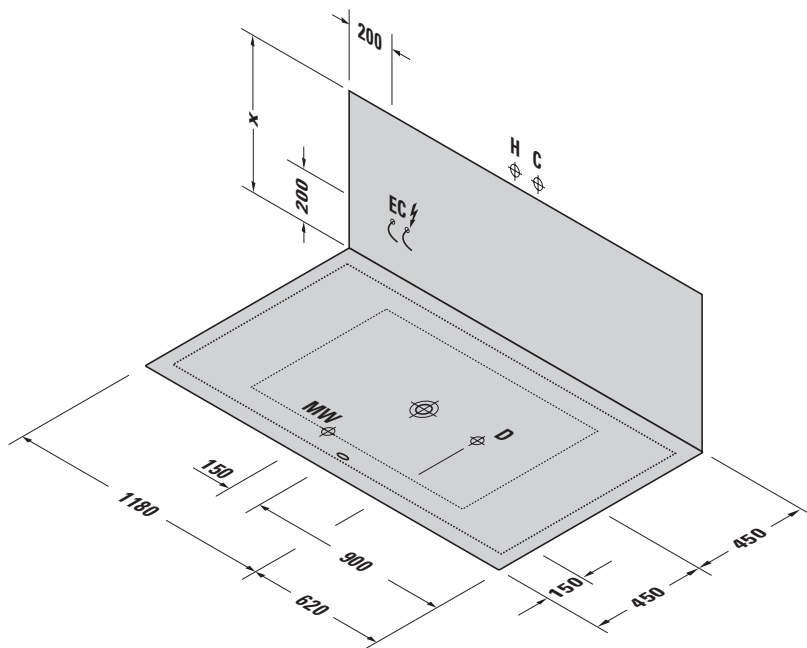

Siphon for bathtub # 700052

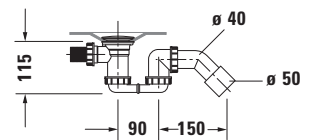

Siphon for whirltub # 760052

- H Hot water connection
- C Cold water connection
- D Drain connection
- MW Mixed water connection for outlet and overflow fittings with inlet function
- EC Electricity connection

	Height	including feet	including support	including panel	including acrylic panel
X Bathtub	485	605 - 675	~ 590	-	-
X Whirltub	-	605 - 640	-	-	-

### Technical specifications

Net weight kg	Floor load kg/m <sup>2</sup>	Shipping weight kg	Shipping dimensions l x w x h (cm)	Water inlet OD, ID	Whirlsystem	Model-No.
42,5	219	57,5	120 x 80 x 195	3/4", 1/2"		700052 00 0 00 0000
54,0	226	96,0	202 x 105 x 86	3/4"	Air-System	760052 00 0 AS 0000
57,0	228	99,0	202 x 105 x 86	3/4"	Jet-System	760052 00 0 JS 1000
63,0	231	105,0	202 x 105 x 86	3/4"	Combi-System P	760052 00 0 CP 1000
76,0 - 83,0	240 - 244	118,0 - 125,0	202 x 105 x 86	3/4"	Combi-System E	760052 00 0 CE 1000
83,0 - 89,0	244 - 248	125,0 - 131,0	202 x 105 x 86	3/4"	Combi-System L	760052 00 0 CL 1000

# Pre-installation Starck # 700331/760331

↳ 1500 x 700 x 440 ‹

Design by Philippe Starck

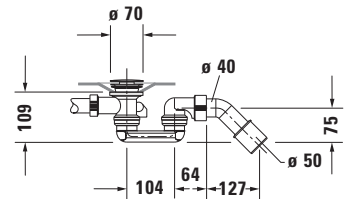
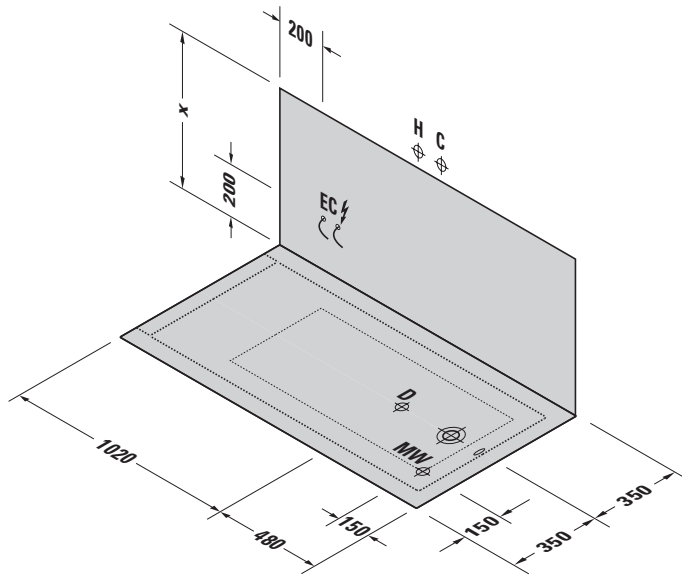

Siphon for bathtub # 700331

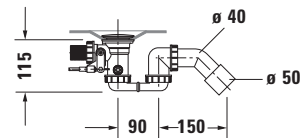

Siphon for whirltub # 760331

- H Hot water connection
- C Cold water connection
- D Drain connection
- MW Mixed water connection for outlet and overflow fittings with inlet function
- EC Electricity connection

	Height	including feet	including support	including panel	including acrylic panel
X Bathtub	485	605 - 675	~ 600	600	600
X Whirltub	-	605 - 640	-	600	600

### Technical specifications

Net weight kg	Floor load kg/m <sup>2</sup>	Shipping weight kg	Shipping dimensions l x w x h (cm)	Water inlet OD, ID	Whirlsystem	Model-No.
24,0	195	39,0	120 x 80 x 165	3/4", 1/2"		700331 00 0 00 0000
35,0	206	77,0	202 x 105 x 86	3/4"	Air-System	760331 00 0 AS 0000
39,0	210	81,0	202 x 105 x 86	3/4"	Jet-System	760331 00 0 JS 1000
44,0	214	86,0	202 x 105 x 86	3/4"	Combi-System P	760331 00 0 CP 1000
57,0 - 64,0	227 - 233	99,0 - 106,0	202 x 105 x 86	3/4"	Combi-System E	760331 00 0 CE 1000
64,0 - 71,0	233 - 240	106,0 - 113,0	202 x 105 x 86	3/4"	Combi-System L	760331 00 0 CL 1000

# Pre-installation Starck # 700332/760332

↳ 1500 x 750 x 440 ‹

Design by Philippe Starck

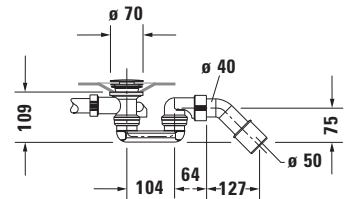
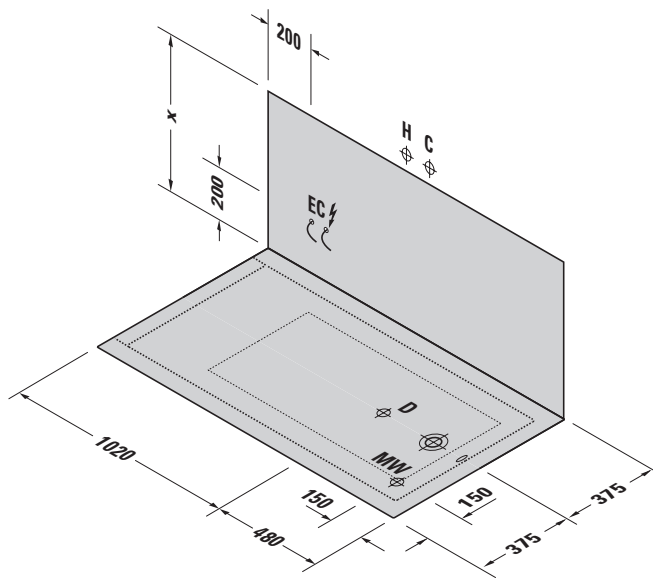

Siphon for bathtub # 700332

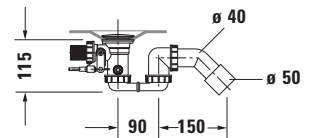

Siphon for whirltub # 760332

- H Hot water connection
- C Cold water connection
- D Drain connection
- MW Mixed water connection for outlet and overflow fittings with inlet function
- EC ⚡ Electricity connection

	Height	including feet	including support	including panel	including acrylic panel
X Bathtub	485	605 - 675	~ 600	600	600
X Whirltub	-	605 - 640	-	600	600

## Technical specifications

Net weight kg	Floor load kg/m <sup>2</sup>	Shipping weight kg	Shipping dimensions l x w x h (cm)	Water inlet OD, ID	Whirlsystem	Model-No.
24,5	200	39,5	120 x 80 x 165	3/4", 1/2"		700332 00 0 00 0000
36,0	210	78,0	202 x 105 x 86	3/4"	Air-System	760332 00 0 AS 0000
39,0	212	81,0	202 x 105 x 86	3/4"	Jet-System	760332 00 0 JS 1000
45,0	218	87,0	202 x 105 x 86	3/4"	Combi-System P	760332 00 0 CP 1000
58,0 - 65,0	229 - 236	100,0 - 107,0	202 x 105 x 86	3/4"	Combi-System E	760332 00 0 CE 1000
65,0 - 71,0	236 - 241	107,0 - 113,0	202 x 105 x 86	3/4"	Combi-System L	760332 00 0 CL 1000

# Pre-installation Starck # 700333/760333

1600 x 700 x 460

Design by Philippe Starck

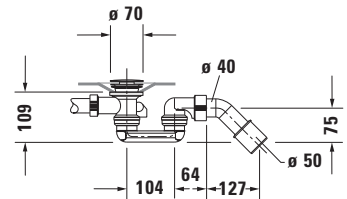
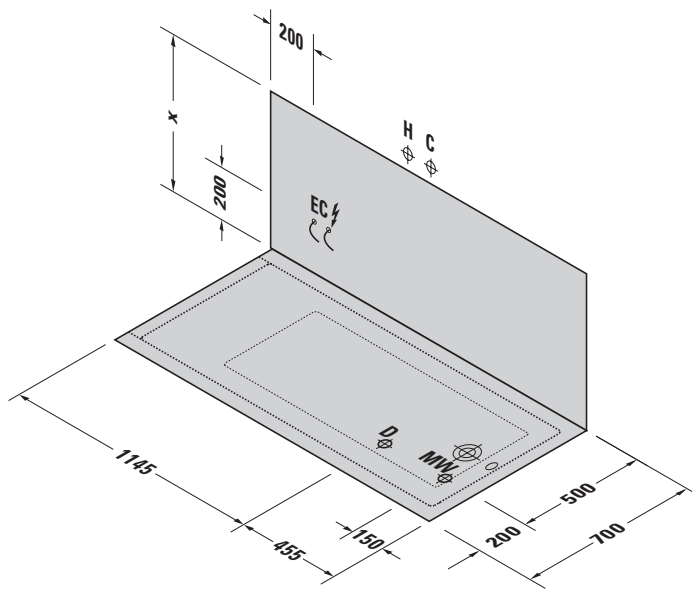

Siphon for bathtub # 700333

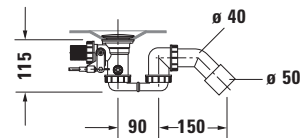

Siphon for whirltub # 760333

- H Hot water connection
- C Cold water connection
- D Drain connection
- MW Mixed water connection for outlet and overflow fittings with inlet function
- EC Electricity connection

	Height	including feet	including support	including panel	including acrylic panel
X Bathtub	485	605 - 675	~ 600	600	600
X Whirltub	-	605 - 640	-	600	600

### Technical specifications

Net weight kg	Floor load kg/m <sup>2</sup>	Shipping weight kg	Shipping dimensions l x w x h (cm)	Water inlet OD, ID	Whirlsystem	Model-No.
26,0	197	41,0	120 x 80 x 175	3/4", 1/2"		700333 00 0 00 0000
37,0	207	79,0	202 x 105 x 86	3/4"	Air-System	760333 00 0 AS 0000
41,0	211	83,0	202 x 105 x 86	3/4"	Jet-System	760333 00 0 JS 1000
46,0	215	88,0	202 x 105 x 86	3/4"	Combi-System P	760333 00 0 CP 1000
59,0 - 66,0	227 - 233	101,0 - 108,0	202 x 105 x 86	3/4"	Combi-System E	760333 00 0 CE 1000
66,0 - 73,0	233 - 239	108,0 - 115,0	202 x 105 x 86	3/4"	Combi-System L	760333 00 0 CL 1000

# Pre-installation Starck # 700334/760334

↳ 1700 x 700 x 460 ‹

Design by Philippe Starck

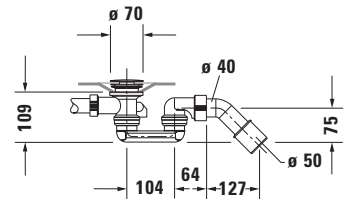
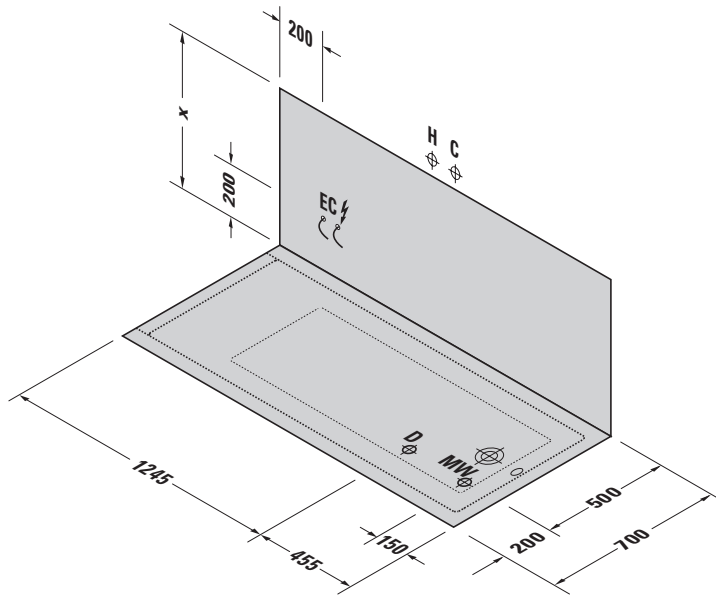

Siphon for bathtub # 700334

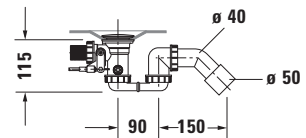

Siphon for whirltub # 760334

- H Hot water connection
- C Cold water connection
- D Drain connection
- MW Mixed water connection for outlet and overflow fittings with inlet function
- EC Electricity connection

	Height	including feet	including support	including panel	including acrylic panel
X Bathtub	485	605 - 675	~ 600	600	600
X Whirltub	-	605 - 640	-	600	600

### Technical specifications

Net weight kg	Floor load kg/m <sup>2</sup>	Shipping weight kg	Shipping dimensions l x w x h (cm)	Water inlet OD, ID	Whirlsystem	Model-No.
27,5	204	42,5	120 x 80 x 185	3/4", 1/2"		700334 00 0 00 0000
39,0	213	81,0	202 x 105 x 86	3/4"	Air-System	760334 00 0 AS 0000
42,0	216	84,0	202 x 105 x 86	3/4"	Jet-System	760334 00 0 JS 1000
48,0	221	90,0	202 x 105 x 86	3/4"	Combi-System P	760334 00 0 CP 1000
61,0 - 68,0	232 - 238	103,0 - 110,0	202 x 105 x 86	3/4"	Combi-System E	760334 00 0 CE 1000
68,0 - 74,0	238 - 243	110,0 - 116,0	202 x 105 x 86	3/4"	Combi-System L	760334 00 0 CL 1000

# Pre-installation Starck # 700335/760335

↳ 1700 x 750 x 460 ‹

Design by Philippe Starck

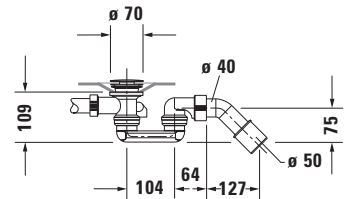
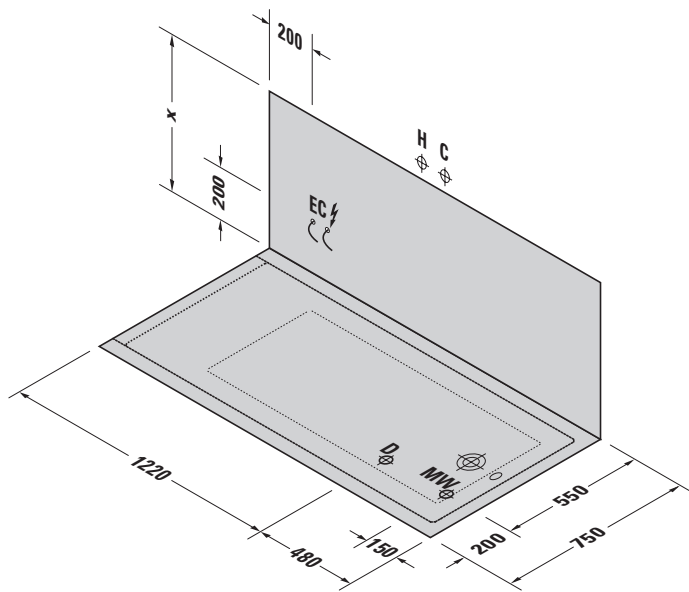

Siphon for bathtub # 700335

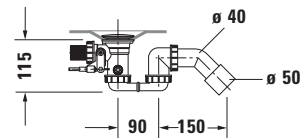

Siphon for whirltub # 760335

- H** Hot water connection
- C** Cold water connection
- D** Drain connection
- MW** Mixed water connection for outlet and overflow fittings with inlet function
- EC** Electricity connection

	Height	including feet	including support	including panel	including acrylic panel
<b>X</b> Bathtub	485	605 - 675	~ 600	600	600
<b>X</b> Whirltub	-	605 - 640	-	600	600

### Technical specifications

Net weight kg	Floor load kg/m <sup>2</sup>	Shipping weight kg	Shipping dimensions l x w x h (cm)	Water inlet OD, ID	Whirlsystem	Model-No.
29,0	199	44,0	120 x 80 x 185	3/4", 1/2"		700335 00 0 00 0000
40,0	208	82,0	202 x 105 x 86	3/4"	Air-System	760335 00 0 AS 0000
44,0	211	86,0	202 x 105 x 86	3/4"	Jet-System	760335 00 0 JS 1000
49,0	215	91,0	202 x 105 x 86	3/4"	Combi-System P	760335 00 0 CP 1000
62,0 - 69,0	225 - 231	104,0 - 111,0	202 x 105 x 86	3/4"	Combi-System E	760335 00 0 CE 1000
69,0 - 76,0	231 - 236	111,0 - 118,0	202 x 105 x 86	3/4"	Combi-System L	760335 00 0 CL 1000

# Pre-installation Starck # 700336/760336

1700 x 800 x 460

Design by Philippe Starck

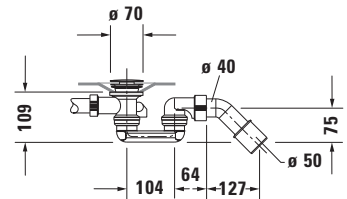
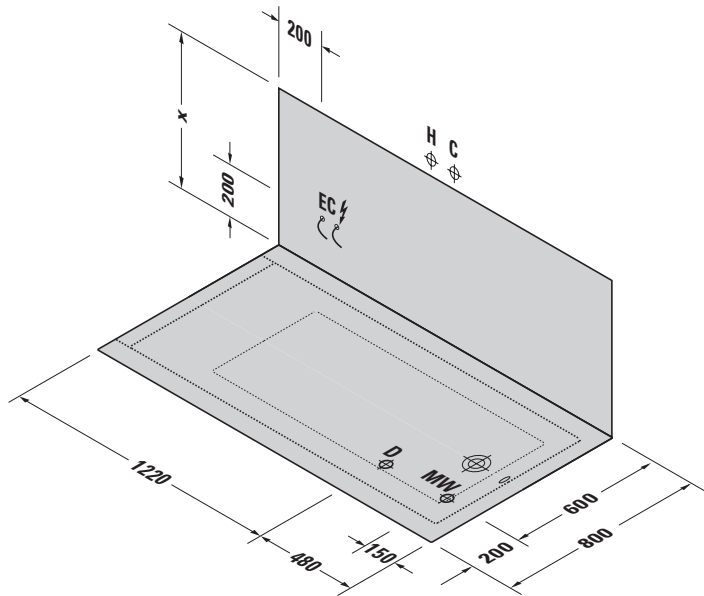

Siphon for bathtub # 700336

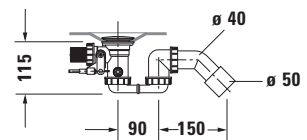

Siphon for whirltub # 760336

- H Hot water connection
- C Cold water connection
- D Drain connection
- MW Mixed water connection for outlet and overflow fittings with inlet function
- EC Electricity connection

	Height	including feet	including support	including panel	including acrylic panel
X Bathtub	485	605 - 675	~ 600	600	600
X Whirltub	-	605 - 640	-	600	600

### Technical specifications

Net weight kg	Floor load kg/m <sup>2</sup>	Shipping weight kg	Shipping dimensions l x w x h (cm)	Water inlet OD, ID	Whirlsystem	Model-No.
29,5	203	44,5	120 x 80 x 185	3/4", 1/2"		700336 00 0 00 0000
41,0	211	83,0	202 x 105 x 86	3/4", 1/2"	Air-System	760336 00 0 AS 0000
44,0	213	86,0	202 x 105 x 86	3/4", 1/2"	Jet-System	760336 00 0 JS 1000
50,0	218	92,0	202 x 105 x 86	3/4", 1/2"	Combi-System P	760336 00 0 CP 1000
63,0 - 70,0	227 - 232	105,0 - 112,0	202 x 105 x 86	3/4", 1/2"	Combi-System E	760336 00 0 CE 1000
70,0 - 76,0	232 - 237	112,0 - 118,0	202 x 105 x 86	3/4", 1/2"	Combi-System L	760336 00 0 CL 1000

# Pre-installation Starck # 700337/760337

1700 x 900 x 460

Design by Philippe Starck

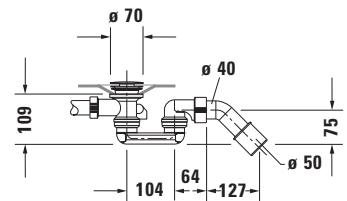
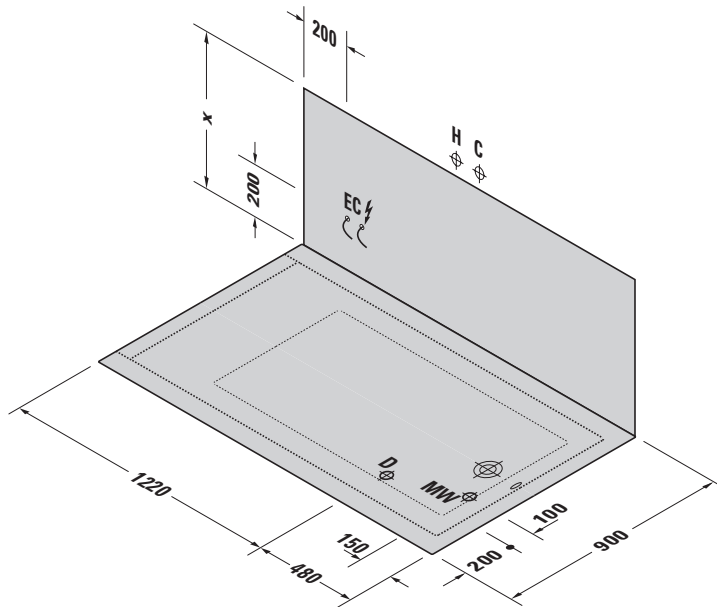

Siphon for bathtub # 700337

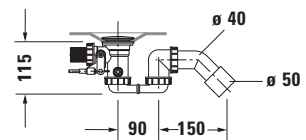

Siphon for whirltub # 760337

- H Hot water connection
- C Cold water connection
- D Drain connection
- MW Mixed water connection for outlet and overflow fittings with inlet function
- EC Electricity connection

	Height	including feet	including support	including panel	including acrylic panel
X Bathtub	485	605 - 675	~ 600	600	600
X Whirltub	-	605 - 640	-	600	600

### Technical specifications

Net weight kg	Floor load kg/m <sup>2</sup>	Shipping weight kg	Shipping dimensions l x w x h (cm)	Water inlet OD, ID	Whirlsystem	Model-No.
33,5	206	48,5	120 x 80 x 185	3/4", 1/2"		700337 00 0 00 0000
45,0	213	87,0	202 x 105 x 86	3/4", 1/2"	Air-System	760337 00 0 AS 0000
48,0	215	90,0	202 x 105 x 86	3/4", 1/2"	Jet-System	760337 00 0 JS 1000
54,0	219	96,0	202 x 105 x 86	3/4", 1/2"	Combi-System P	760337 00 0 CP 1000
67,0 - 74,0	227 - 232	109,0 - 116,0	202 x 105 x 86	3/4", 1/2"	Combi-System E	760337 00 0 CE 1000
74,0 - 80,0	232 - 236	116,0 - 122,0	202 x 105 x 86	3/4", 1/2"	Combi-System L	760337 00 0 CL 1000



# Pre-installation Starck # 700338/760338

↳ 1800 x 800 x 460 ‹

Design by Philippe Starck

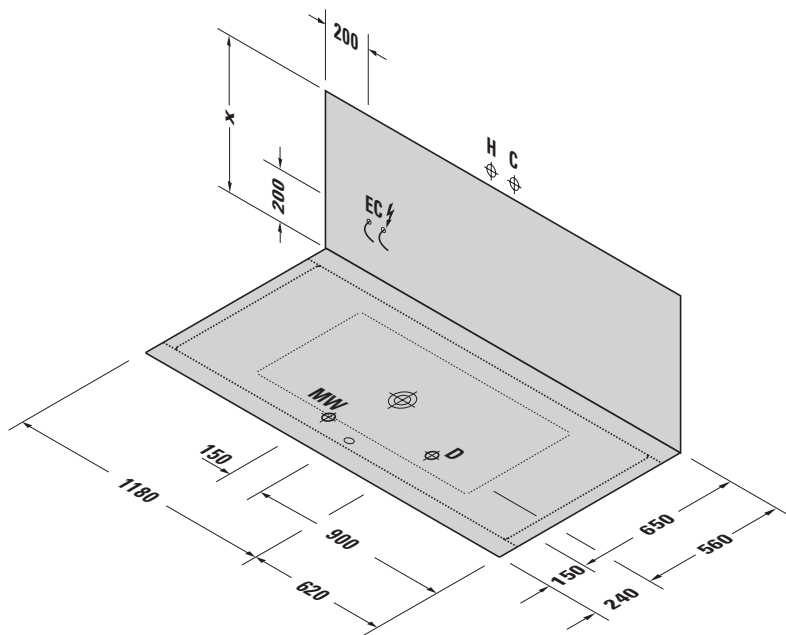

- H Hot water connection
- C Cold water connection
- D Drain connection
- MW Mixed water connection for outlet and overflow fittings with inlet function
- EC Electricity connection

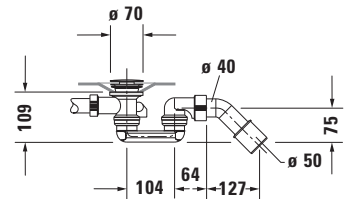

Siphon for bathtub # 700338

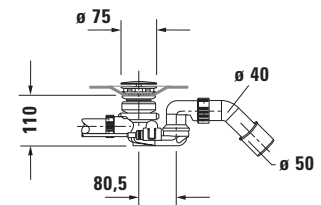

Siphon with base inlet for bathtub #700338

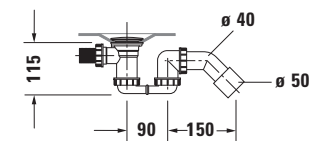

Siphon for whirltub # 760338

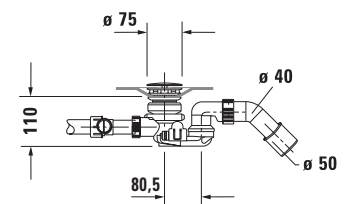

Siphon with base inlet for whirltub #760338

	Height	including feet	including support	including panel	including acrylic panel
X Bathtub	485	605 - 675	~ 600	600	600
X Whirltub	-	605 - 640	-	600	600

### Technical specifications

Net weight kg	Floor load kg/m <sup>2</sup>	Shipping weight kg	Shipping dimensions l x w x h (cm)	Water inlet OD, ID	Whirlsystem	Model-No.
31,5	184	46,5	120 x 80 x 195	3/4", 1/2"		700338 00 0 00 0000
43,0	192	85,0	202 x 105 x 86	3/4", 1/2"	Air-System	760338 00 0 AS 0000
46,0	194	88,0	202 x 105 x 86	3/4", 1/2"	Jet-System	760338 00 0 JS 1000
52,0	199	94,0	202 x 105 x 86	3/4", 1/2"	Combi-System P	760338 00 0 CP 1000
65,0 - 72,0	208 - 213	107,0 - 114,0	202 x 105 x 86	3/4", 1/2"	Combi-System E	760338 00 0 CE 1000
72,0 - 78,0	213 - 217	114,0 - 120,0	202 x 105 x 86	3/4", 1/2"	Combi-System L	760338 00 0 CL 1000

# Pre-installation Starck # 700339/760339

↳ 1800 x 900 x 460 ‹

Design by Philippe Starck

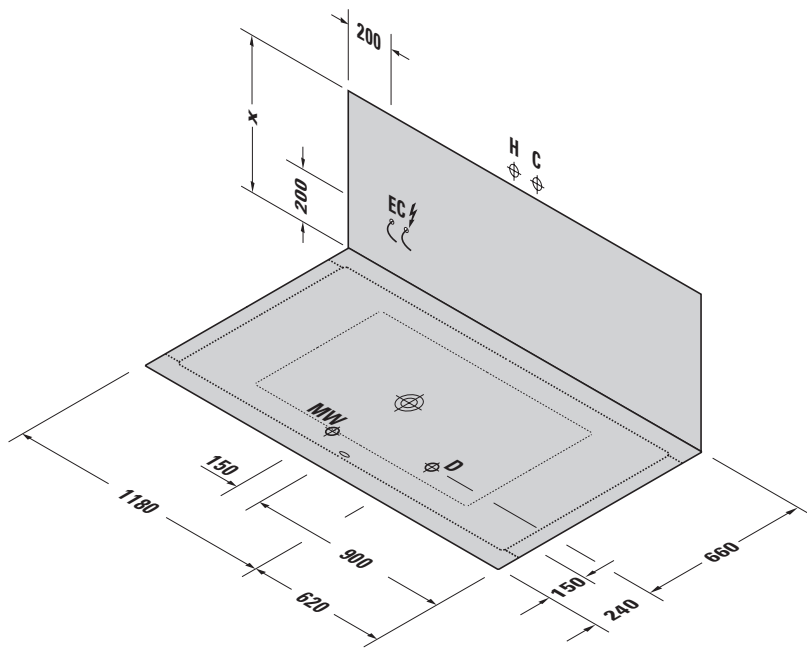

- H Hot water connection
- C Cold water connection
- D Drain connection
- MW Mixed water connection for outlet and overflow fittings with inlet function
- EC Electricity connection

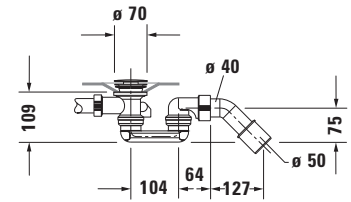

Siphon for bathtub # 700339

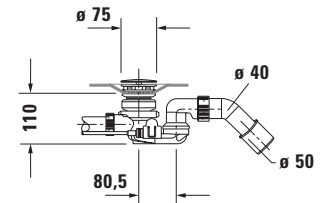

Siphon with base inlet for bathtub #700339

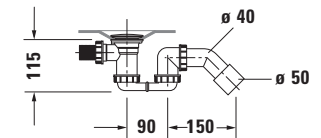

Siphon for whirltub # 760339

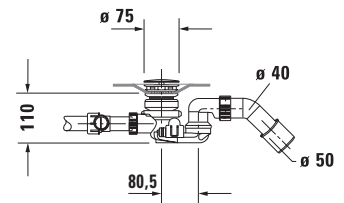

Siphon with base inlet for whirltub #760339

	Height	including feet	including support	including panel	including acrylic panel
X Bathtub	485	605 - 675	~ 600	600	600
X Whirltub	-	605 - 640	-	600	600

## Technical specifications

Net weight kg	Floor load kg/m <sup>2</sup>	Shipping weight kg	Shipping dimensions l x w x h (cm)	Water inlet OD, ID	Whirlsystem	Model-No.
32,5	188	47,5	120 x 80 x 195	3/4", 1/2"		700339 00 0 00 0000
44,0	195	86,0	202 x 105 x 86	3/4", 1/2"	Air-System	760339 00 0 AS 0000
47,0	197	89,0	202 x 105 x 86	3/4", 1/2"	Jet-System	760339 00 0 JS 1000
53,0	201	95,0	202 x 105 x 86	3/4", 1/2"	Combi-System P	760339 00 0 CP 1000
66,0 - 73,0	209 - 213	108,0 - 115,0	202 x 105 x 86	3/4", 1/2"	Combi-System E	760339 00 0 CE 1000
73,0 - 79,0	213 - 217	115,0 - 121,0	202 x 105 x 86	3/4", 1/2"	Combi-System L	760339 00 0 CL 1000

# Pre-installation Starck # 700340/760340

↳ 1900 x 900 x 460 ‹

Design by Philippe Starck

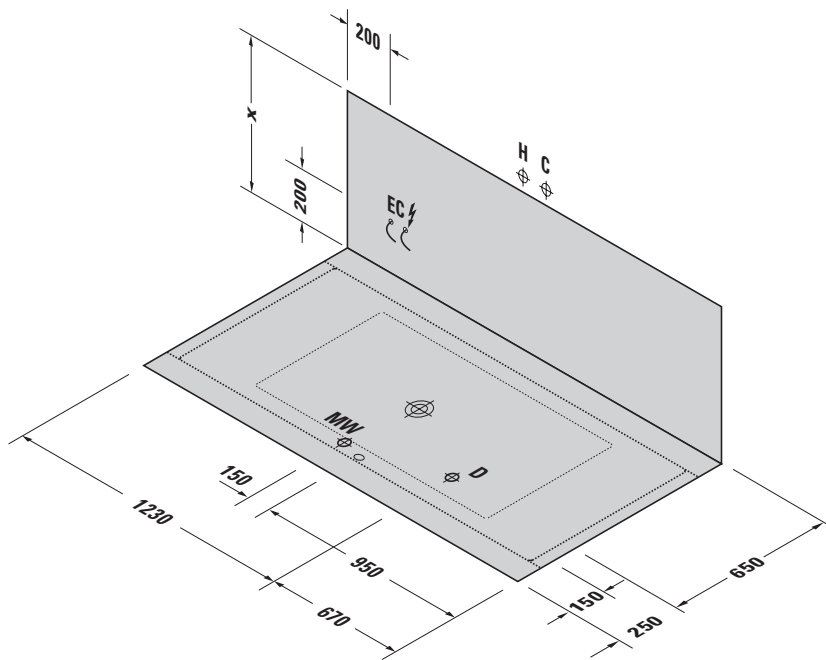

- H** Hot water connection
- C** Cold water connection
- D** Drain connection
- MW** Mixed water connection for outlet and overflow fittings with inlet function
- EC** Electricity connection

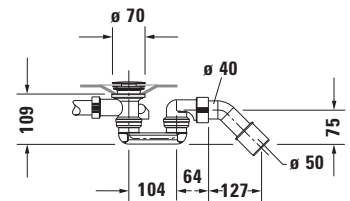

Siphon for bathtub # 700340

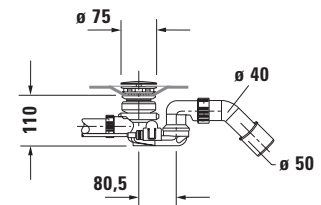

Siphon with base inlet for bathtub #700340

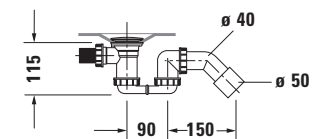

Siphon for whirltub # 760340

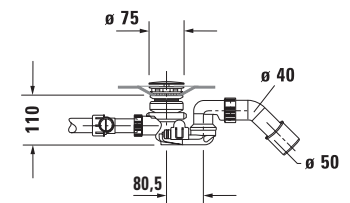

Siphon with base inlet for whirltub #760340

	Height	including feet	including support	including panel	including acrylic panel
<b>X</b> Bathtub	485	605 - 675	~ 600	600	600
<b>X</b> Whirltub	-	605 - 640	-	600	600

## Technical specifications

Net weight kg	Floor load kg/m <sup>2</sup>	Shipping weight kg	Shipping dimensions l x w x h (cm)	Water inlet OD, ID	Whirlsystem	Model-No.
33,6	196	48,6	120 x 80 x 205	3/4", 1/2"		<b>700340 00 0 00 0000</b>
45,0	202	87,0	202 x 105 x 86	3/4", 1/2"	Air-System	<b>760340 00 0 AS 0000</b>
48,0	204	90,0	202 x 105 x 86	3/4", 1/2"	Jet-System	<b>760340 00 0 JS 1000</b>
54,0	208	96,0	202 x 105 x 86	3/4", 1/2"	Combi-System P	<b>760340 00 0 CP 1000</b>
67,0 - 74,0	215 - 219	109,0 - 116,0	202 x 105 x 86	3/4", 1/2"	Combi-System E	<b>760340 00 0 CE 1000</b>
74,0 - 80,0	219 - 223	116,0 - 122,0	202 x 105 x 86	3/4", 1/2"	Combi-System L	<b>760340 00 0 CL 1000</b>

# Pre-installation Starck # 700341/760341

↳ 2000 x 1000 x 460 ‹

Design by Philippe Starck

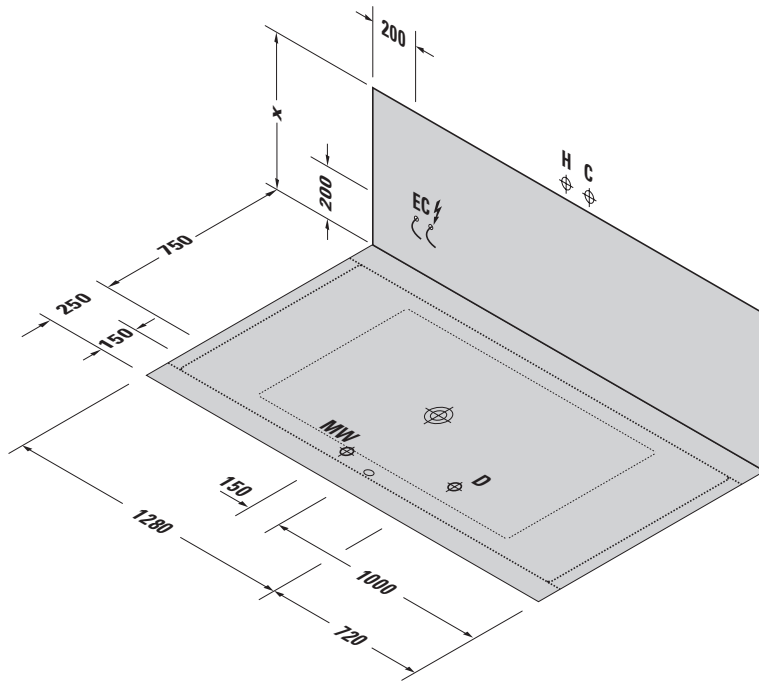

- H Hot water connection
- C Cold water connection
- D Drain connection
- MW Mixed water connection for outlet and overflow fittings with inlet function
- EC Electricity connection

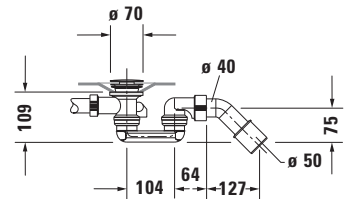

Siphon for bathtub # 700341

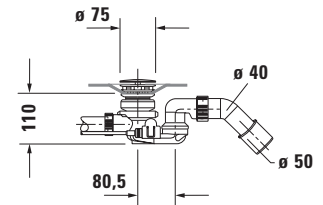

Siphon with base inlet for bathtub #700341

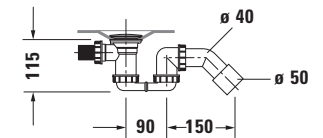

Siphon for whirltub # 760341

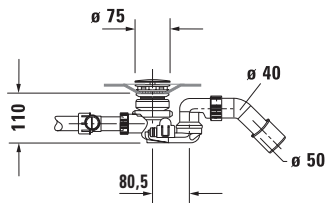

Siphon with base inlet for whirltub #760341

	Height	including feet	including support	including panel	including acrylic panel
X Bathtub	485	605 - 675	~ 600	600	600
X Whirltub	-	605 - 640	-	600	600

## Technical specifications

Net weight kg	Floor load kg/m <sup>2</sup>	Shipping weight kg	Shipping dimensions l x w x h (cm)	Water inlet OD, ID	Whirlsystem	Model-No.
39,5	204	54,5	120 x 80 x 215	3/4", 1/2"		700341 00 0 00 0000
51,0	210	93,0	202 x 105 x 86	3/4", 1/2"	Air-System	760341 00 0 AS 0000
54,0	212	96,0	202 x 105 x 86	3/4", 1/2"	Jet-System	760341 00 0 JS 1000
60,0	215	102,0	202 x 105 x 86	3/4", 1/2"	Combi-System P	760341 00 0 CP 1000
73,0 - 80,0	221 - 225	115,0 - 122,0	202 x 105 x 86	3/4", 1/2"	Combi-System E	760341 00 0 CE 1000
80,0 - 86,0	225 - 228	122,0 - 128,0	202 x 105 x 86	3/4", 1/2"	Combi-System L	760341 00 0 CL 1000

**DURAVIT AG**  
P.O. Box 240  
Werderstr. 36  
78132 Hornberg  
Germany  
Phone +49 78 33 70 0  
Fax +49 78 33 70 289  
info@duravit.com  
www.duravit.com

