

INSTALLATION AND MAINTENANCE MANUAL

NABOO

SAPIENS

AROMA NABOO

AROMA SAPIENS

CAUTION: Read the instructions
prior to using the equipment

MODELS

Each letter of the model number identifies an oven feature followed by a number that identifies the capacity of the model.

NA_B = Naboo with boiler

NA_V = Naboo with direct steam

NA_M = Naboo with boiler + Naboo with direct steam

SA_B = Sapiens with boiler

SA_V = Sapiens with direct steam

SA_M = Sapiens with boiler + Sapiens with direct steam

AR_N = Aroma Naboo

AR_S = Aroma Sapiens

E = Electric

G = Gas

CAPACITY

7 x GN 1/1 (**071**)

7 x GN 2/1 (**072**)

10 x GN 1/1 (**101**)

10 x GN 2/1 (**102**)

17 x GN 1/1 (**171**)

20 x GN 1/1 (**201**)

20 x GN 2/1 (**202**)

6 x (600x400) (**064**)

8 x (600x400) (**084**)

14 x (600x400) (**144**)

15 x (600x400) (**154**)

Technical service



CONTENTS

	Page
1 • GENERAL REMINDERS	5
2 • TECHNICAL DATA	6
3 • SPECIAL REQUIREMENTS FOR THE INSTALLATION SITE	10
4 • STATUTORY REQUIREMENTS, TECHNICAL REGULATIONS AND DIRECTIVES	11
5 • POSITIONING	11
6 • ELECTRICAL CONNECTIONS AND EQUIPOTENTIAL BONDING	14
7 • POINTS TO REMEMBER WHEN MAKING THE ELECTRICAL CONNECTION	15
8 • WATER AND DRAIN CONNECTIONS	16
9 • WASHING SYSTEM	18
10 • CALOUT	26
11 • VENTS	28
12 • GAS CONNECTION PROCEDURES	29
13 • OPERATING AT THE RATED HEAT OUTPUT	31
14 • COMMISSIONING AND TESTING	40
15 • IMPORTANT INFORMATION FOR THE USER	41
16 • DISMANTLING AND DISPOSAL	42
17 • INSTALLATION DIAGRAMS	43

The manufacturer accepts no liability for any inaccuracies in this manual attributable to printing or copying errors. We reserve the right to modify our products as we deem fit, without impairing their basic features.

The reproduction or copying of any part of this manual by any means whatsoever is strictly forbidden unless authorized previously in writing by the manufacturer.

- ORIGINAL INSTRUCTIONS -

1 • GENERAL REMINDERS

- **The oven must be installed, commissioned and maintained only by an authorized service agent.**

- **Carefully read** the directions given in this manual; they contain important information on safety during installation, operation and maintenance.

Keep this manual in a safe place for future consultation!

- This appliance must be put **only to the use for which it is specifically intended**, i.e. cooking foods; any other type of use is improper and therefore dangerous.

- Use suitable lifting systems or accessories when handling the equipment or packaging.

- Having removed the packing **check that the appliance is not damaged in any way.** If in doubt, proceed no further with installation of the appliance and contact the Customer Service or your dealer immediately.

- Packing materials **are potentially dangerous and must not be left where children** can play with them.



- Packing materials **must be disposed of in conformity with local regulations.** This normally means that the different materials are sorted according to type and collected as urban refuse.

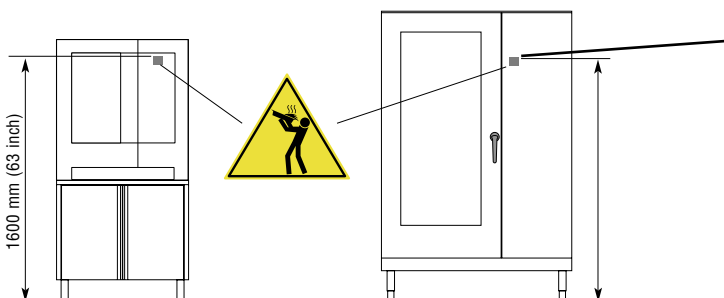

- Before positioning and connecting the appliance, check that the utilities (electrical power, water and gas supplies) **are as indicated on the data plate.**

The data plate is on the right-hand side, at the bottom.



- Example of a data plate:

LOGO		
TYP. XXXXXXXXX		
2014	NR XXXXXXXXXX	
3N AC 400V 50Hz		
1 x 0.25 kW	TOT 8 kW	kPa 200 - 500 
IPX 5		

LOGO		
TYP. XXXXXXXXX		
2014	NR XXXXXXXXXX	
EN 203/A1	AC 230V 50Hz	
1 x 0.55 kW	TOT 1 kW	ΣQn 40 kW
A3 <input type="checkbox"/>	B13 <input type="checkbox"/>	B23 <input type="checkbox"/>
G 25 / m ³ /h	G 20 / m ³ /h	kPa 200 - 500 
Pmax / mbar	Pmax / mbar	G 30 3.16 Kg/h
Pmin / mbar	Pmin / mbar	Pmin / mbar
IT	Cat. II 2H3+	P mbar 20; 28-30/37
IPX 5		 0085

- The positions of the inlet and drain connections are clearly labelled. For further details, see the installation diagram attached to this manual.

- In the event of breakdown or faulty operation, **switch off the oven immediately!**

- During installation and/or maintenance work it is recommended you wear gloves to protect your hands.

- Safety sticker

- Maximum height for inserting containers with liquids.

ATTENTION: to avoid scalding, do not use the containers filled with liquid or food which, through cooking become fluid, at levels higher than those which can be observed.

2 • TECHNICAL DATA

TABLE 1: GENERAL DATA - ELECTRIC OVENS

Model	Supply voltage	Frequency (**)	Total power input	Amps	Chamber power	Boiler power	Motor	Oil-proof connection cable (*)
NAEB071. SAEB071.	3N AC 400 V 3 AC 230 V AC 230 V	50/60 Hz	10,5 kW	16 26 46	10 kW	7,5 kW	1 x 0,37 kW	5 x 2,5 mm ² 4 x 4 mm ² 3 x 10 mm ²
NAEV071. AREN064. SAEV071. ARES064.	3N AC 400 V 3 AC 230 V AC 230 V	50/60 Hz	10,5 kW	16 26 46	10 kW	-	1 x 0,37 kW	5 x 2,5 mm ² 4 x 4 mm ² 3 x 10 mm ²
NAEB101. SAEB101.	3N AC 400 V 3 AC 230 V	50/60 Hz	16 kW	30 54	15 kW	15 kW	1 x 0,55 kW	5 x 4 mm ² 4 x 10 mm ²
NAEV101. AREN084. SAEV101. ARES084.	3N AC 400 V 3 AC 230 V	50/60 Hz	16 kW	24 40	15 kW	-	1 x 0,55 kW	5 x 4 mm ² 4 x 10 mm ²
NAEB072. SAEB072.	3N AC 400 V 3 AC 230 V	50/60 Hz	19 kW	34 60	18 kW	15 kW	1 x 0,55 kW	5 x 6 mm ² 4 x 10 mm ²
NAEV072. SAEV072.	3N AC 400 V 3 AC 230 V	50/60 Hz	19 kW	30 49	18 kW	-	1 x 0,55 kW	5 x 6 mm ² 4 x 10 mm ²
NAEB102. SAEB102.	3N AC 400 V 3 AC 230 V	50/60 Hz	31 kW	46 78	30 kW	30 kW	1 x 0,55 kW	5 x 10 mm ² 4 x 25 mm ²
NAEV102. SAEV102.	3N AC 400 V 3 AC 230 V	50/60 Hz	31 kW	46 78	30 kW	-	1 x 0,55 kW	5 x 10 mm ² 4 x 25 mm ²
NAEB171. SAEB171.	3N AC 400 V 3 AC 230 V	50/60 Hz	26,5 kW	46 80	10+15 kW	7,5 + 15 kW	0,37 + 0,55 kW	5 x 10 mm ² 4 x 25 mm ²
NAEM171. SAEM171.	3N AC 400 V 3 AC 230 V	50/60 Hz	26,5 kW	46 80	10+15 kW	15 kW	0,37 + 0,55 kW	5 x 10 mm ² 4 x 25 mm ²
NAEV171. AREN144. SAEV171. ARES144.	3N AC 400 V 3 AC 230 V	50/60 Hz	26,5 kW	40 66	10+15 kW	-	0,37 + 0,55 kW	5 x 10 mm ² 4 x 25 mm ²
NAEB201. SAEB201.	3N AC 400 V 3 AC 230 V	50/60 Hz	31,8 kW	60 103	30 kW	30 kW	2 x 0,55 kW	5 x 10 mm ² 4 x 25 mm ²
NAEV201. AREN154. SAEV201. ARES154.	3N AC 400 V 3 AC 230 V	50/60 Hz	31,8 kW	48 80	30 kW	-	2 x 0,55 kW	5 x 10 mm ² 4 x 25 mm ²
NAEB202. SAEB202.	3N AC 400 V 3 AC 230 V	50/60 Hz	61,8 kW	92 155	60 kW	60 kW	2 x 0,55 kW	5 x 25 mm ² 2x (4 x 25 mm ²)
NAEV202. SAEV202.	3N AC 400 V 3 AC 230 V	50/60 Hz	61,8 kW	92 155	60 kW	-	2 x 0,55 kW	5 x 25 mm ² 2x (4 x 25 mm ²)

Caution: The residual current device to be installed between the mains and the appliance must be sized for a leakage of 1 mA x kW of power installed.

(*) Flexible cable underneath sheath resistant to oil with designation 60245-IEC-57

(**) for ovens compatible with operation at a frequency of 60 Hz, the data is the same. Always check the frequency shown on the technical data label affixed to the appliance.

2 • TECHNICAL DATA

TABLE 2: GENERAL DATA GAS OVENS

Model	Supply voltage	Frequency (**)	Input	Motor	Oil-proof connection cable (*)	Gas power w/boiler	Gas power w/o boiler	Gas connection
NAGB071. SAGB071.	AC 230 V	50/60 Hz	0,5 kW	1 x 0,37 kW	3 x 1 mm ²	15 kW	-	1 x R 1/2"
NAGV071. ARGN064. SAGV071. ARGS064.	AC 230 V	50/60 Hz	0,5 kW	1 x 0,37 kW	3 x 1 mm ²	-	12 kW	1 x R 1/2"
NAGB101. SAGB101.	AC 230 V	50/60 Hz	1 kW	1 x 0,55 kW	3 x 1 mm ²	28 kW	-	1 x R 1/2"
NAGV101. ARGN084. SAGV101. ARGS084.	AC 230 V	50/60 Hz	1 kW	1 x 0,55 kW	3 x 1 mm ²	-	18 kW	1 x R 1/2"
NAGB072. SAGB072.	AC 230 V	50/60 Hz	1 kW	1 x 0,55 kW	3 x 1 mm ²	30 kW	-	1 x R 1/2"
NAGV072. SAGV072.	AC 230 V	50/60 Hz	1 kW	1 x 0,55 kW	3 x 1 mm ²	-	20 kW	1 x R 1/2"
NAGB102. SAGB102.	AC 230 V	50/60 Hz	1 kW	1 x 0,55 kW	3 x 1 mm ²	40 kW	-	1 x R 1/2"
NAGV102. SAGV102.	AC 230 V	50/60 Hz	1 kW	1 x 0,55 kW	3 x 1 mm ²	-	27 kW	1 x R 1/2"
NAGB171. SAGB171.	AC 230 V	50/60 Hz	0,5 kW + 1 kW	1 x 0,37 kW + 1 x 0,55 kW	3 x 1,5 mm ²	43 kW	-	2 x R 1/2"
NAGM171. SAGM171.	AC 230 V	50/60 Hz	0,5 kW + 1 kW	1 x 0,37 kW + 1 x 0,55 kW	3 x 1,5 mm ²	28 kW	12 kW	2 x R 1/2"
NAGV171. ARGN144. SAGV171. ARGS144.	AC 230 V	50/60 Hz	0,5 kW + 1 kW	1 x 0,37 kW + 1 x 0,55 kW	3 x 1,5 mm ²	-	30 kW	2 x R 1/2"
NAGB201. SAGB201.	AC 230 V	50/60 Hz	1,8 kW	2 x 0,55 kW	3 x 1,5 mm ²	48 kW	-	1 x R 3/4"
NAGV201. ARGN154. SAGV201. ARGS154.	AC 230 V	50/60 Hz	1,8 kW	2 x 0,55 kW	3 x 1,5 mm ²	-	36 kW	1 x R 3/4"
NAGB202. SAGB202.	AC 230 V	50/60 Hz	1,8 kW	2 x 0,55 kW	3 x 1,5 mm ²	80 kW	-	1 x R 3/4"
NAGV202. SAGV202.	AC 230 V	50/60 Hz	1,8 kW	2 x 0,55 kW	3 x 1,5 mm ²	-	54 kW	1 x R 3/4"

Caution: The residual current device to be installed between the mains and the appliance must be sized for a leakage of 1 mA x kW of power installed.

(*) Flexible cable underneath sheath resistant to oil with designation 60245-IEC-57

(**) for ovens compatible with operation at a frequency of 60 Hz, the data is the same. Always check the frequency shown on the technical data label affixed to the appliance.

2 • TECHNICAL DATA

TABLE 3: GENERAL WATER DATA

WITH STEAM GENERATOR					WITHOUT STEAM GENERATOR				
	Model	Water pressure kPa	Softened water consumption max. l/h	Water connection		Model	Water pressure kPa	Softened water consumption max. l/h	Water connection
ELECTRIC	7 x GN 1/1 6 x 600x400	200 - 500	10	2 x R 3/4 ⁽¹⁾	ELECTRIC	7 x GN 1/1 6 x 600x400	200 - 500	8	2 x R 3/4 ⁽¹⁾
	7 x GN 2/1 10 x GN 1/1	200 - 500	19	2 x R 3/4 ⁽¹⁾		7 x GN 2/1 10 x GN 1/1 10 x 600x400	200 - 500	15	2 x R 3/4 ⁽¹⁾
	10 x GN 2/1	200 - 500	30	2 x R 3/4 ⁽¹⁾		10 x GN 2/1	200 - 500	15	2 x R 3/4 ⁽¹⁾
	7 x GN 1/1 + 10 x GN 1/1	200 - 500	29	2 x R 3/4 ⁽¹⁾		7 x GN 1/1 + 10 x GN 1/1 6 x 600x400 + 8 x 600x400	200 - 500	23	2 x R 3/4 ⁽¹⁾
	20 x GN 1/1	200 - 500	37	2 x R 3/4 ⁽¹⁾		20 x GN 1/1 15 x 600x400	200 - 500	30	2 x R 3/4 ⁽¹⁾
	20 x GN 2/1	200 - 500	68	2 x R 3/4 ⁽¹⁾		20 x GN 2/1	200 - 500	30	2 x R 3/4 ⁽¹⁾
GAS	7 x GN 1/1	200 - 500	8	2 x R 3/4 ⁽¹⁾	GAS	7 x GN 1/1 6 x 600x400	200 - 500	15	2 x R 3/4 ⁽¹⁾
	7 x GN 2/1 10 x GN 1/1	200 - 500	17	2 x R 3/4 ⁽¹⁾		7 x GN 2/1 10 x GN 1/1 10 x 600x400	200 - 500	22	2 x R 3/4 ⁽¹⁾
	7 x GN 1/1 + 10 x GN 1/1	200 - 500	25	2 x R 3/4 ⁽¹⁾		10 x GN 2/1	200 - 500	22	2 x R 3/4 ⁽¹⁾
	10 x GN 2/1	200 - 500	24	2 x R 3/4 ⁽¹⁾		7 x GN 1/1 + 10 x GN 1/1 6 x 600x400 + 8 x 600x400	200 - 500	37	2 x R 3/4 ⁽¹⁾
	20 x GN 1/1	200 - 500	24	2 x R 3/4 ⁽¹⁾		20 x GN 1/1 15 x 600x400	200 - 500	30	2 x R 3/4 ⁽¹⁾
	20 x GN 2/1	200 - 500	48	2 x R 3/4 ⁽¹⁾		20 x GN 2/1	200 - 500	44	2 x R 3/4 ⁽¹⁾

⁽¹⁾ The ovens are equipped with two water inlets, one for non-softened cold water and the other for hot water (max. 50 C) or softened cold water.

TABLE 4: FLUE GAS EXTRACTION DATA (TYPE B13)

Models	7 x GN 1/1	10 x GN 1/1	10 x GN 2/1	20 x GN 1/1	20 x GN 2/1
Flue liner pressure	- 0,9 Pa	- 1,8 Pa	- 2,7 Pa	- 2,2 Pa	-
Volumetric mass	18,6 g/sec.	28,4 g/sec.	34,5 g/sec.	39,9 g/sec.	-
Flue gas Temperature	145 °C	190 °C	250 °C	210 °C	-

2 • TECHNICAL DATA

TABLE 5: GENERAL DATA - NET WEIGHT

Naboo Model	Net Weight Kg.
NAEB071.	139
NAEB101.	174
NAEB072.	180
NAEB102.	240
NAEB171.	275
NAEM171.	268
NAEB201.	330
NAEB202.	395
NAGB071.	156
NAGB101.	186
NAGB072.	220
NAGB102.	235
NAGB171.	325
NAGM171.	315
NAGB201.	345
NAGB202.	465

Naboo Model	Net Weight Kg.
NAEV071.	117
NAEV101.	142
NAEV072.	158
NAEV102.	201
NAEV171.	255
NAEV201.	260
NAEV202.	345
NAGV071.	125
NAGV101.	180
NAGV072.	203
NAGV102.	218
NAGV171.	284
NAGV201.	290
NAGV202.	400

Sapiens Model	Net Weight Kg.
SAEB071.	139
SAEB101.	174
SAEB072.	180
SAEB102.	240
SAEB171.	275
SAEM171.	268
SAEB201.	330
SAEB202.	395
SAGB071.	156
SAGB101.	186
SAGB072.	220
SAGB102.	235
SAGB171.	325
SAGM171.	315
SAGB201.	345
SAGB202.	465

Sapiens Model	Net Weight Kg.
SAEV071.	117
SAEV101.	142
SAEV072.	158
SAEV102.	201
SAEV171.	255
SAEV201.	260
SAEV202.	345
SAGV071.	125
SAGV101.	180
SAGV072.	203
SAGV102.	218
SAGV171.	284
SAGV201.	290
SAGV202.	400

Aroma by Naboo Model	Net Weight Kg.
AREN064.	117
AREN084.	142
AREN144.	255
AREN154.	260
ARGN064.	125
ARGN084.	180
ARGN144.	284
ARGN154.	290

Aroma by Sapiens Model	Net Weight Kg.
ARES064.	117
ARES084.	142
ARES144.	255
ARES154.	260
ARGS064.	125
ARGS084.	180
ARGS144.	284
ARGS154.	290

3 • SPECIAL REQUIREMENTS FOR THE INSTALLATION SITE

- 3.1** • The room where the oven is to be fitted has to be well ventilated with all the openings required for rooms with gas installations (see specific regulations).
- 3.2** • In addition, it is good policy to locate the appliance under an extractor hood so that cooking vapours can be removed rapidly and continuously.
- 3.3** • The room must have a flue gas extraction stack (appliances with installation type B13), or a suitable flue gas extraction system fitted with all relevant safety devices (appliances with installation type B23). Further details are given under the heading: “*Gas connection procedures*”. Check with the appropriate agency whether or not special authorization is required for the emission of flue gases into the atmosphere.
- 3.4** • Current IEC (International Electrotechnical Committee) regulations require the installation of a multiple pole switch between the oven and the electrical power supply; the switch must have a contact gap of at least 3 mm on each pole.
- 3.5** • The oven needs two water supplies, one of which does not need to be softened, but does need to be cooled (for steam condensation).
For direct steam ovens, the other supply system must have a softener with adequate capacity and pressure (see the technical data and chapter regarding the water hookup).
If the oven has a steam generator, a softener does not need to be installed.
All supply lines upstream of the appliance require a shut-off valve.
- 3.6** • The room must have a water drain in a good position for the oven to be installed, its specifications are given under the heading “*Water and drain connections*” in this manual.
- 3.7** • The gas supply plumbing must be installed in accordance with current regulations, adopting pipe sections and pressures suitable for the appliance (see technical data and gas connections heading).
A fast acting shutoff valve must be installed on the gas inlet line to the appliance. It is absolutely essential that this valve should be specified to current standards and type test approved.
- 3.8** • The electrical isolating switch and the water and gas shutoff valves must all be located near to the appliance, within easy reach for the user.

4 • STATUTORY REQUIREMENTS, TECHNICAL REGULATIONS AND DIRECTIVES

Throughout installation it is vital to observe the following requirements:

- 4.1 Throughout installation it is vital to observe the following requirements:
- 4.1 • any health and hygiene standards applicable to kitchens and eating places;
- 4.2 • local and/or territorial building regulations and fire prevention standards;
- 4.3 • current accident prevention guidelines;
- 4.4 • IEC requirements relating to electrical systems;
- 4.5 • UNI-CIG 8723 Standard “Gas systems for appliances used in professional kitchens and communal facilities”;
- 4.6 • the regulations of the gas supply company or agency;
- 4.7 • the regulations of the electrical power supply company or agency;
- 4.8 • any other local regulations.

5 • POSITIONING

- 5.1 • To position the appliances, it is recommended to use the mount offered by the manufacturer; should you want to do things differently, it is necessary to take account of the weight of the appliance.

Current fire regulations should be meticulously observed and respected. Do not obstruct the openings and slots in the casing as they disperse the heat in the electric component compartment.
Keep strictly to the installation diagrams.
- 5.2 • Before permanently fixing the oven in position, the water, electrical and gas connections must be made (see relative sections).
- 5.3 • The distances from other appliances or from adjacent walls that must be left to allow access for servicing operations will be found on the installation diagram for the oven to connect. In the event of the oven being installed directly against an inflammable wall, suitable heat insulation must be provided.
- 5.4 • Once the appliance is installed, the electrical power cable must be protected, and never stretched or tugged.
- 5.5 • The appliance must be level: any difference in level or sloping of the supporting surface should be eliminated. Differences in level or sloping negatively affect oven operation.

5 • POSITIONING

• LIFTING AND HANDLING OF FLOOR-STANDING OVENS

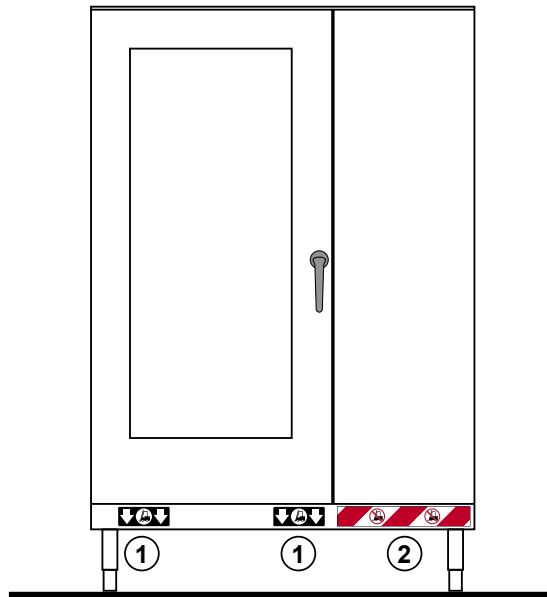

- 5.6 • Lift the appliance using forklifts or jack pallets only where indicated



Do not insert forklift or jack pallet forks in the areas marked with



CAUTION: the centre of gravity of the appliance is shifted to the right with respect to the central axis, therefore, given that it tends to tilt during lifting, it is important to proceed with caution, lifting it slowly by the minimum necessary amount and manually supporting it, if possible, on the right-hand side.

During handling, slight dragging of the right-hand feet along the floor is allowed.

DO NOT LIFT TOO MUCH, RISK OF TIPPING.

- 5.7 • To remove the appliance from the pallet using a forklift, cautiously and slightly lift it by the minimum necessary amount, manually supporting it on the right-hand side, then pull the pallet out from underneath and lay it slowly on the floor.

Do not lift it too much and do not move with the forklift during this operation. This can only be done once it has been lowered as close as possible to the floor.

5 • POSITIONING

- 5.8** • Remove all packing materials and peel away the protective plastic film from all external surfaces of the oven.
- 5.9** • For free-standing models, the appliance needs to be levelled: small differences in level of the supporting surface can be eliminated with the adjustable feet (by screwing or unscrewing them). A significantly uneven or sloping stance can affect the operation of the oven adversely. For models equipped with a pan trolley, it is necessary to pay special attention when levelling.

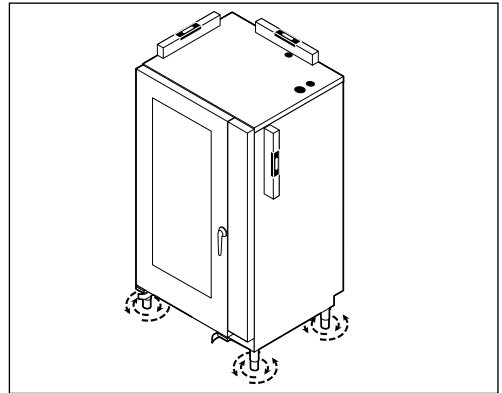

- 5.10** • **Lining up the pan trolleys.** If the floor is not level, a remedy must be found using an access ramp with a maximum gradient of 4° (not included in the supply). If there is an outlet grate in front of the appliance, it is necessary to fit runners in the pan trolley entry area.

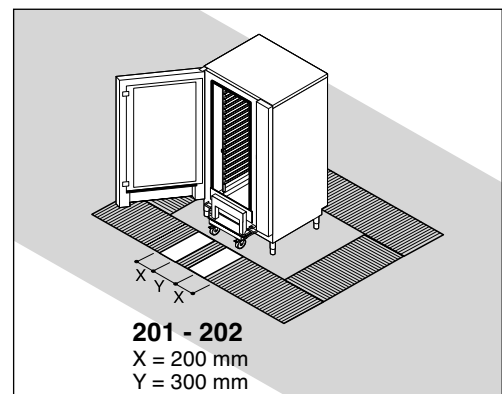
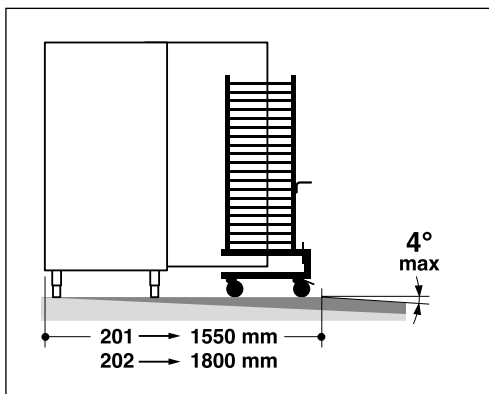
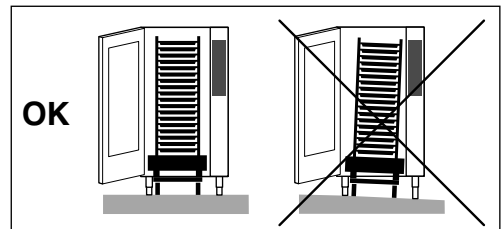
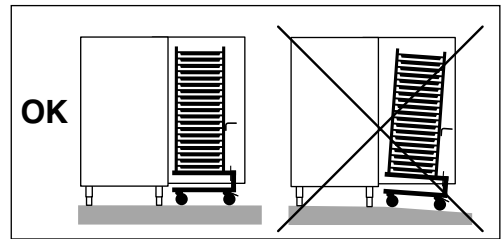

6 • ELECTRICAL CONNECTIONS AND EQUIPOTENTIAL BONDING

- 6.1** • As this oven is an appliance with a type Y attachment, (oven without power cable and plug), the cable and other hardware needed to make the connection to the electrical power supply must be provided by the installer. The cable must satisfy the requirements indicated in table 1 “*General data*”. As already mentioned, the oven must be connected to the power supply by way of a multiple pole main isolating switch ensuring a gap between open contacts of at least 3 mm on each pole.
- 6.2** • To gain access to the AC mains connection terminal board, the right hand panel of the casing must be removed by undoing the fixing screws (all models).
- 6.3** • The cable must be fed in from beneath the clamp. The individual wires are then fastened to the corresponding terminals of the terminal board. The earth wire must be longer than the other wires, so that in the event of the cable being jerked or the clamp broken, the live wires will disconnect first.
Check the efficiency of the isolating switch.
- 6.4** • The oven must be kept in an equipotential system. This connection is made by wiring a conductor of nominal cross section 10 mm² to the corresponding terminal at the back of the oven, which is marked with the internationally recognized symbol IEC60417 – 5021.
All appliances in the room are bonded in this way and connected to the earth system of the building.
- 6.5** • The electrical safety of this appliance can be guaranteed only when it is connected correctly to an efficient earth system, in compliance with current standards.
- 6.6** • If the supply cord is damaged, it must be replaced by the manufacturer, its service agent or similarly qualified persons in order to avoid a hazard.

7 • POINTS TO REMEMBER WHEN MAKING THE ELECTRICAL CONNECTION

- 7.1** • As all ovens of the series are fitted with an alternating fan motor (clockwise and anticlockwise rotation), there is no need for the fan to rotate in any particular direction. Simply verify, when commissioning the appliance, that the fan is balanced and rotates freely. **Warning:** the 20 x GN 1/1 and 20 x GN 2/1 models are equipped with two motors.
- 7.2** • When making the electrical connection you need to take care that the neutral pin of the terminal block corresponds to the neutral wire of the supply line. If this connection is not made correctly, the burners will not be able to operate. This error is signalled by the electronic circuit board.
- 7.3** • Check also that the neutral registers zero potential when tested. If not, the fault already described in point three of this section will occur. In this eventuality, consult the installer of the building's electrical system.

8 • WATER AND DRAIN CONNECTIONS

Appliances are intended to be permanently connected to the water mains

8.1 • WATER PRESSURE

The pressure of the water in the network must be between 200 and 500 kPa, as already stated under the heading "Technical Data". If the supply pressure is higher than this, a pressure reduction valve must be installed between the oven and the main.

8.2 • WATER HOOKUP TO SUPPLY THE STEAM GENERATOR (IF PRESENT) AND VAPORIZER

Direct steam ovens:

The vaporizer requires softened cold or hot (max 50°C) water depending upon the characteristics.

Ovens with steam generators:

The vaporizer and steam generator do not require a softener and can use cold or hot (max 50°C) water.

The water attachment is R 3/4". The water hose must be provided by the installer and must be in compliance to IEC 61770. Do not reuse pre-existing or used hoses. A water shut-off valve must be installed upstream of the oven.

8.3 • WATER SPECIFICATIONS

The characteristics of the water must come within the limits given below, in order to prevent both corrosion, which is extremely damaging for the appliance, due to supplying water that is too softened or too aggressive, and scaling in the oven and in the water system in the case of supplying water that is too hard.

Hardness: **between 6° and 9° fH**

PH: **greater than 7.5**

Chlorides: **less than 30 ppm**

These values are important for ensuring that the water used by the appliance is suitably treated!

8.4 • WATER CONNECTION FOR STEAM CONDENSATION

Cold water must be hooked up for steam condensation. The water attachment is R 3/4". The water hose must be provided by the installer and must be in compliance to IEC 61770. Do not reuse pre-existing or used hoses. A water shut-off valve must be installed upstream of the oven.

It is advisable not to use a treatment system that causes carbonate hardness less than 6 °fH as water having these characteristics may be aggressive and corrosive, thus shortening the service life of the appliance.

UK only:

WRAS approval IRN 160. To be carried out by the installer: An approved double check valve or some other no less effective backflow prevention device shall be fitted at the point of connection between the supply and the fitting.

Recommended water composition limits:

CL ⁻	max 30 mg/l
Fe	max 0,1 mg/l
Mn	max 0,05 mg/l
Cu	max 0,05 mg/l
Cl ₂	max 0,1 mg/l
Water conductivity: 50 - 200 µs	

Water hardness parameters conversion table

	°fH (°tH)	°dH	°eH (Clark°)	ppm (mg/l)	gr/gal (US)
1 °fH (°tH)	1	0,56	0,7	10	0,6
1 °dH	1,79	1	1,25	17,9	1,07
1 °eH (Clark°)	1,43	0,8	1	14,28	0,86
1 ppm (mg/l)	0,1	0,06	0,07	1	0,06
1 gr/gal (US)	1,71	0,96	1,2	17,15	1

8 • WATER AND DRAIN CONNECTIONS

8.5 • DRAINING

The water is drained off by gravity through a heat-resistant pipe **DN 50** (not flexible), maximum length 2 m, installed at an angle of no less than 4°.

Mean temperature of the drain water: 65 °C.

For the range with the drain as per fig.1 it is possible to make a direct connection with an air trap, without fitting a drain cup, as the drainage manifold system has an internal air drop (Fig. 2). In the case of floor drains without trap, an air gap must be developed with a minimum clearance of 2 cm. (Fig. 3).

Fig. 1



Fig. 2

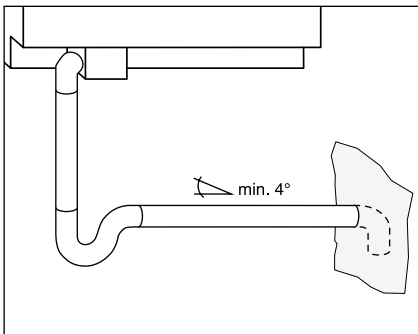
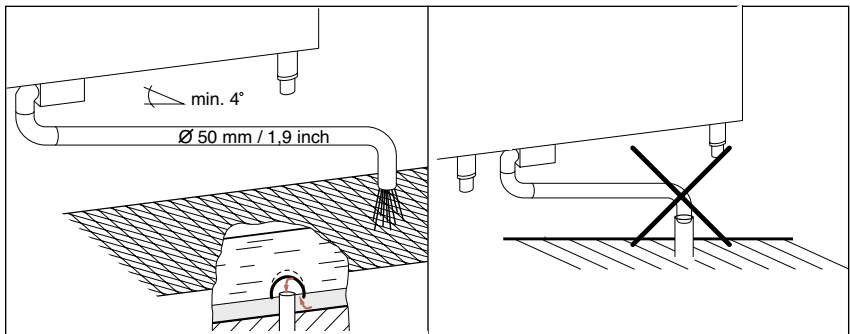
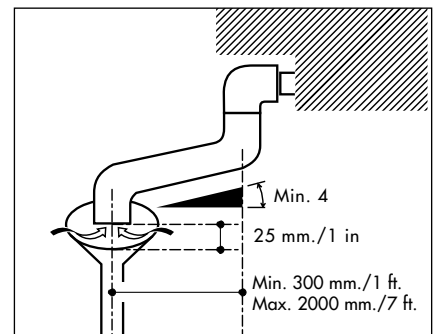

Fig. 3



For the remaining models an air gap cup must be interposed guaranteeing a minimum clearance of 25 mm between the appliance's plastic drain bend and the drain piping. **Direct connections are prohibited.**



WARNING:

The drain must be outside the oven perimeter, Min. 300 mm./1 ft. and Max. 2000 mm / 7 ft.

It is prohibited to reduce the drain diameter.

9 • WASHING SYSTEM

AVAILABLE WASHING SYSTEM TYPES

FOR COUNTERTOP MODELS: 071 / 101 / 072 / 102 / 064 / 084

LIQUID DETERGENTS



SOLID DETERGENTS



FOR FLOOR MODELS: 171 / 201 / 202 / 144 / 154

ONLY LIQUID DETERGENTS



9 • WASHING SYSTEMS

LIQUID DETERGENTS

FOR SA.... / ARGS.... / ARES.... MODELS

9.1 • POSITIONING AND SETTING COMBICLEAN DETERGENT CARTRIDGE/CONTAINER

The **COMBICLEAN** cartridge/container has a **YELLOW** cap.

COUNTERTOP MODELS: Open the oven door and the door below the oven cooking chamber.

Put the cartridge in the oven housing.

IMPORTANT: Wait for the liquid to stabilize before opening the cap.

Remove the cap from the new cartridge and insert the hose with the **YELLOW** cap, making sure the hose is turned to the front of the cartridge, and close the cap tightly.

FLOOR MODELS:

Position the container close to the oven.

IMPORTANT: Wait for the liquid to stabilize before opening the cap.

Remove the cap from the container and insert the hose with the **YELLOW** cap, making sure it reaches the bottom of the container, and close the cap tightly.

With the device receiving power and the display off, press the button **6** "Cooking programs/Recipes". The upper display **7** shows **[USb]**. Turn the upper knob **8** until **[hrs]** is displayed. Press the upper knob **8** to confirm the selection.

Turn the upper knob **8** until **[dEt]** is shown on the upper display **7**.

If the lower display **9** shows a value other than **[100]** press buttons **2 - 4 - 15** for 3 seconds (until display **7** shows **[100]**), otherwise press button **6** to exit.

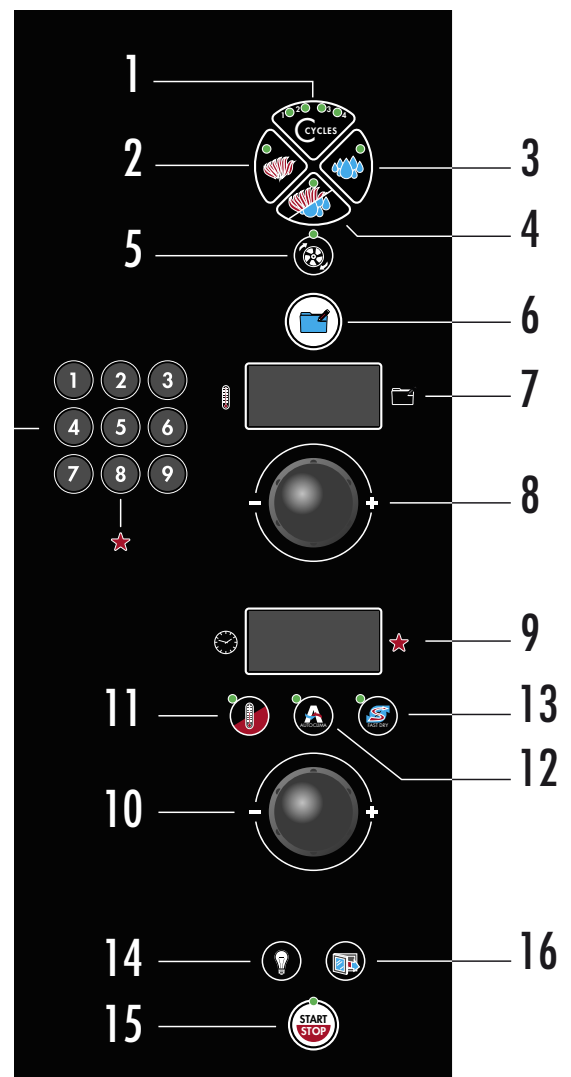

FOR SA.... / ARGs.... / ARES.... MODELS

9.2 • POSITIONING AND SETTING CALFREE DESCALER CARTRIDGE/CONTAINER

The **CALFREE** descaler cartridge/container has a **GREEN** cap.

COUNTERTOP MODELS: Open the oven door and the door below the oven cooking chamber.

Put the cartridge in the oven housing.

IMPORTANT: Wait for the liquid to stabilize before opening the cap.

Remove the cap from the new cartridge and insert the hose with the **GREEN** cap, making sure the hose is turned to the front of the cartridge, and close the cap tightly.

FLOOR MODELS Position the container near the oven.

IMPORTANT: Wait for the liquid to stabilize before opening the cap.

Remove the cap from the container and insert the hose with the **GREEN** cap, making sure it reaches the bottom of the container, and close the cap tightly.

With the device receiving power and the display off, press the button **6** "Cooking programs/Recipes". The upper display **7** shows **[USb]**. Turn the upper knob **8** until **[hrs]** is displayed. Press the upper knob **8** to confirm the selection.

Turn the upper knob **8** until **[SCA]** is shown on the upper display **7**.

If the lower display **9** shows a value other than **[100]** press buttons **2 - 4 - 15** for 3 seconds (until display **7** shows **[100]**), otherwise press button **6** to exit.

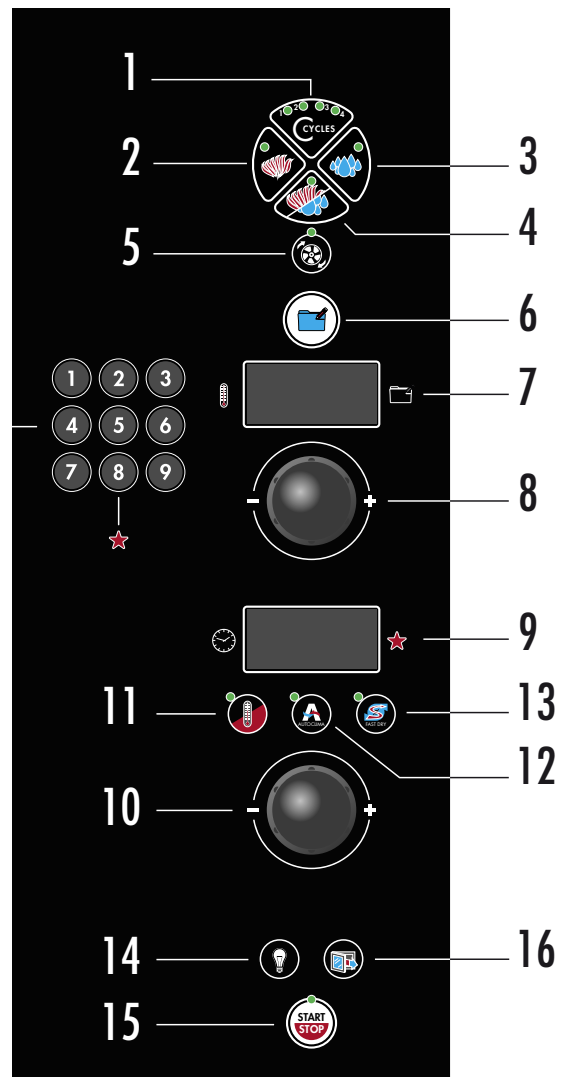

FOR SA....R / ARGS....R / ARES...R. MODELS

9.3 • REPLACING THE COMBICLEAN DETERGENT CARTRIDGE

If when you recall the **ECO, SOFT, HARD** or **HARD PLUS** wash procedure, the message “Check COMBICLEAN level” appears on display **15**, check the detergent level:

Counter top model: open the oven door and the hatch located under the oven's cooking chamber and check the amount of detergent in the cartridge.

Floor-standing model: check the quantity of detergent in the tank.

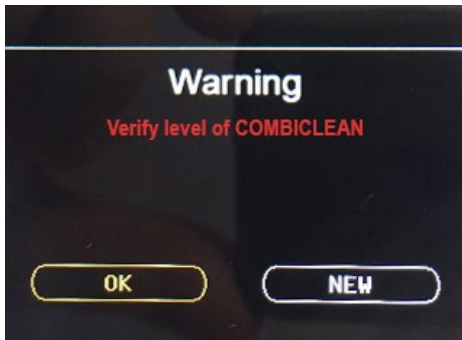

If the cartridge/tank is empty, replace it following the instructions in the following paragraph, otherwise confirm the “OK” message by pressing knob **16** to start the wash.

The “**COMBICLEAN**” detergent cartridge has a **YELLOW** coloured cap.

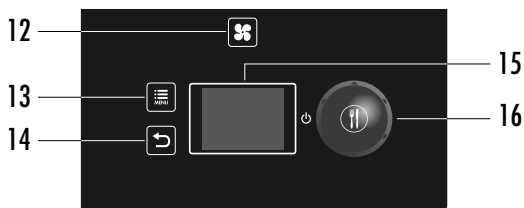

9.3.1 • COUNTER TOP MODEL - REPLACING THE CARTRIDGE:

Unscrew the cap of the empty cartridge and remove it.

Position the new cartridge in its dedicated housing in the oven.

IMPORTANT: Wait for the liquid to stabilise before opening the cap.

Remove the cap from the new cartridge and insert the tube with the **YELLOW** cap, making sure that the tube is facing the front part of the cartridge, and close the cap well.

Turn knob **16**, select “New” and confirm by pressing knob **16** to continue with the wash procedure.

9.3.2 • FLOOR-STANDING MODEL - REPLACING THE TANK:

Unscrew the cap of the empty tank and remove it.

Reposition the tank.

IMPORTANT: Wait for the liquid to stabilise before opening the cap.

Remove the cap from the tank and insert the tube with the **YELLOW** cap, making sure that the tube is on the bottom of the tank, and close the cap well.

Turn knob **16**, select “New” and confirm by pressing knob **16** to continue with the wash procedure.

FOR SA....R / ARG....R / ARES....R MODELS

9.4 • REPLACING THE CALFREE DESCALER CARTRIDGE/TANK

If when you recall the **ECO**, **SOFT**, **HARD** or **HARD PLUS** wash procedure, the message “Check CALFREE level” appears on display **15**, check the detergent level:

Counter top model: open the oven door and the hatch located under the oven's cooking chamber and check the amount of detergent in the cartridge.

Floor-standing model: check the quantity of detergent in the tank.

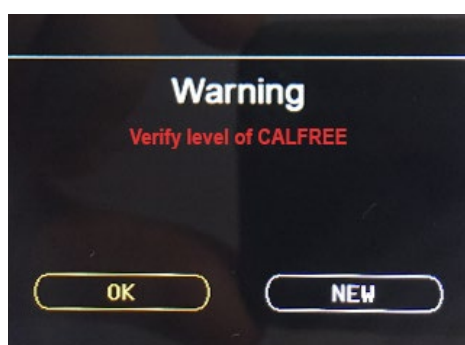

If the cartridge/tank is empty, replace it following the instructions in the following paragraph, otherwise confirm the “OK” message by pressing knob **16** to start the wash.

The “**CALFREE**” descaler cartridge has a GREEN coloured cap.

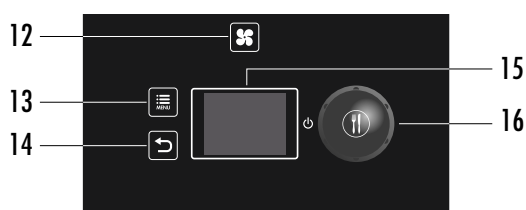

9.4.1 • COUNTER TOP MODEL - REPLACING THE CARTRIDGE:

Unscrew the cap of the empty cartridge and remove it.

Position the new cartridge in its dedicated housing in the oven.

IMPORTANT: Wait for the liquid to stabilise before opening the cap.

Remove the cap from the new cartridge and insert the tube with the **GREEN** cap, making sure that the tube is facing the front part of the cartridge, and close the cap well.

Turn knob **16**, select “New” and confirm by pressing knob **16** to continue with the wash procedure.

9.4.2 • FLOOR-STANDING MODEL - REPLACING THE TANK:

Unscrew the cap of the empty tank and remove it.

Reposition the tank.

IMPORTANT: Wait for the liquid to stabilise before opening the cap.

Remove the cap from the tank and insert the tube with the **GREEN** cap, making sure that the tube is on the bottom of the tank, and close the cap well.

Turn knob **16**, select “New” and confirm by pressing knob **16** to continue with the wash procedure.

FOR NA.... / ARGN.... / AREN....
NA....R / ARGN....R / AREN....R
MODELS

9.5 • POSITIONING AND SETTING COMBICLEAN DETERGENT AND/OR CALFREE DESCALER CARTRIDGE/CONTAINER

The **COMBICLEAN** cartridge/container has
a **YELLOW** cap.

The **CALFREE** descaler cartridge/
container has a **GREEN** cap.

COUNTERTOP MODELS: Open the oven
door and the door below the oven cooking
chamber.

Put the cartridge/container in the oven
housing.

**IMPORTANT: Wait for the liquid to
stabilize before opening the cap.**

Remove the cap from the new cartridge
and insert the hose with the cap (**YELLOW**
for **COMBICLEAN** detergent and **GREEN**
for **CALFREE** descaler), making sure the
hose is turned to the front of the cartridge,
and close the cap tightly.

FLOOR MODELS:

Position the container close to the oven.

**IMPORTANT: Wait for the liquid to
stabilize before opening the cap.**

Remove the cap from the container and
insert the hose with the cap (**YELLOW** for
COMBICLEAN detergent and **GREEN** for
CALFREE descaler), making sure the hose
is turned to the front of the cartridge, and
close the cap tightly.

Press the **SET MAX** button for the
COMBICLEAN or **CALFREE** cartridge/
container replaced.

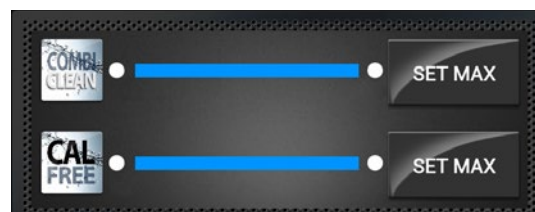

The gauge now shows the blue bar to be
completely full. Choose the desired wash
to start the procedure.

9 • WASHING SYSTEMS

SOLID DETERGENTS

FOR SA.... / ARGS.... / ARES.... MODELS

9.6.1 • FIRST DETERGENT CREATION

Only for appliances equipped with wash kit.

With the device receiving power and the display off, press the button **6** “Cooking programs/Recipes”. The upper display **7** shows **[USB]**. Turn the upper knob **8** until **[CLn]** is displayed. Press the upper knob **8** to confirm the selection.

Turn the upper knob **8** until **[riG]** is shown on the upper display **7** and **[dEt]** is shown on the lower display **9**.

Press **15** “**START/STOP**” to start the detergent creation procedure.

Follow the instructions on the lower display **9** as indicated in paragraph 26 of the manual.

9.6.2 • FIRST DESCALER CREATION

Only for appliances equipped with CALOUT.

With the device receiving power and the display off, press the button **6** “Cooking programs/Recipes”. The upper display **7** shows **[USB]**. Turn the upper knob **8** until **[CLn]** is displayed. Press the upper knob **8** to confirm the selection.

Turn the upper knob **8** until **[riG]** is shown on the upper display **7** and **[SCA]** is shown on the lower display **9**.

Press **15** “**START/STOP**” to start the descaler creation procedure.

Follow the instructions on the lower display **9** as indicated in paragraph 27 of the manual.

9.6.3 • DETERGENT AND DESCALER CREATION

Only for appliances equipped with wash kit and CALOUT.

With the device receiving power and the display off, press the button **6** “Cooking programs/Recipes”. The upper display **7** shows **[USB]**. Turn the upper knob **8** until **[CLn]** is displayed. Press the upper knob **8** to confirm the selection.

Turn the upper knob **8** until **[riG]** is shown on the upper display **7** and **[d-C]** is shown on the lower display **9**.

Press **15** “**START/STOP**” to start the detergent and descaler creation procedure.

Follow the instructions on the lower display **9** as indicated in paragraphs 26 and 27 of the manual.

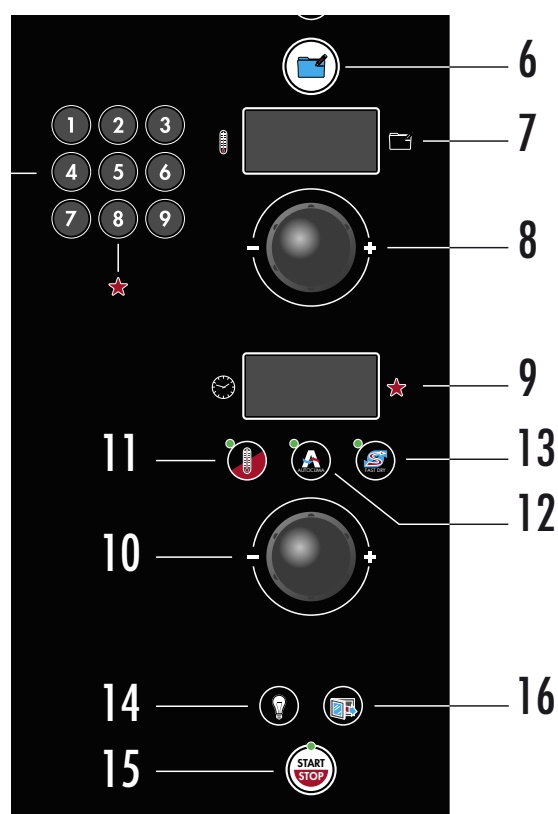

9 • WASHING SYSTEMS

SOLID DETERGENTS

FOR NA.... / ARGN.... / AREN....
NA....R / ARGN....R / AREN....R
MODELS

9.7 • FIRST DETERGENT/DESCALER CREATION



Press the **“SETTINGS”** icon to access the Naboo settings.



Press the **“SERVICE”** icon and key in the password.

Press the **“DRAWER WASHES”** icon

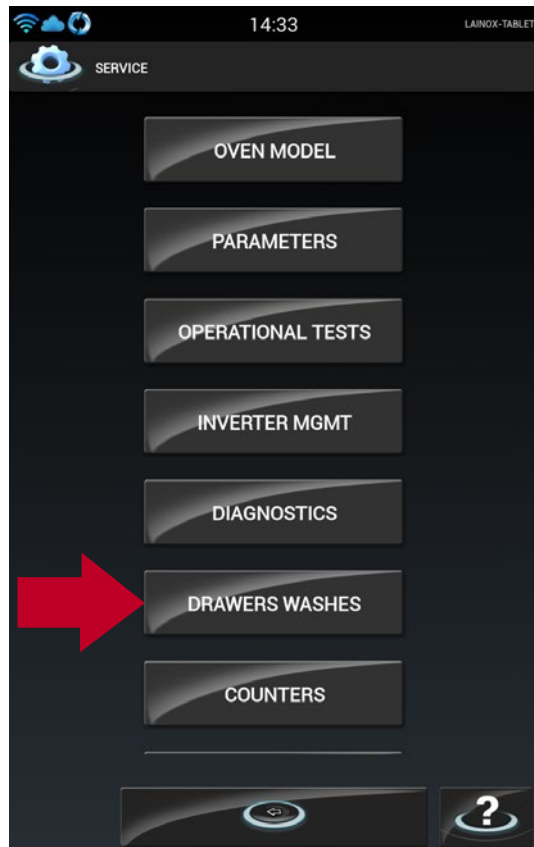

Press the **“Generate SolidClean”** icon and follow the guided procedure to create the detergent.

Press the **“Generate SolidClean”** icon and follow the guided procedure to create the descaler.

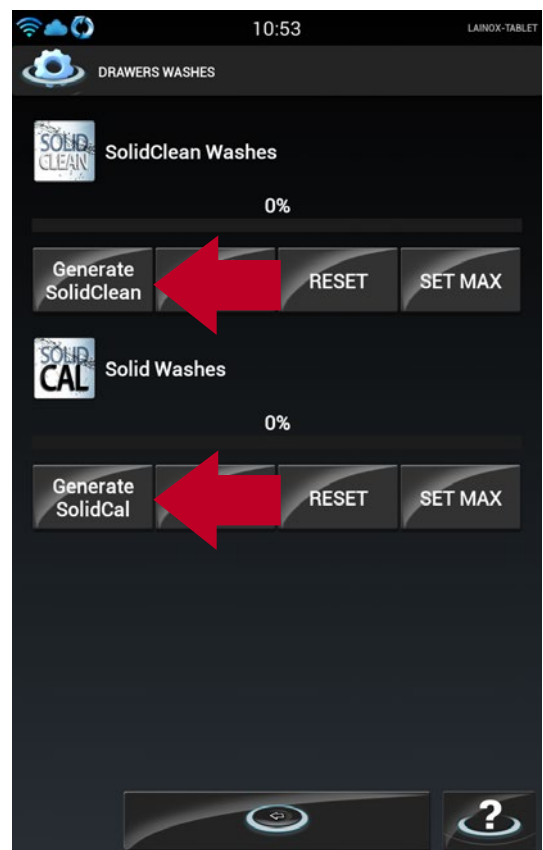

10 • CALOUT (if present)

10.1 • THE CALOUT

The **CALOUT** is a cleaning system, which keeps the steam generator free from limescale and prevents the latter from building up.

The **CALOUT** system is available for ovens equipped with steam generator.

The **CALOUT** system allows for periodic cleaning of the steam generator through a specific program to be initiated by the user when signalled by the oven warning (see the oven user manual).

The ovens equipped with **CALOUT** can be directly connected to the water supply without any need for a water softener.

The water characteristics must still be within the limit values (see chapter 8) in order to prevent corrosion due to overly aggressive water, which could be extremely damaging to the equipment.

WARNING: FAILURE TO COMPLY WITH THE CALOUT USAGE TIMES MAY AFFECT THE OPERATION AND INTEGRITY OF THE STEAM GENERATOR (in this case the steam generator repair or replacement will not be honoured as warranty).

ONLY USE THE “CF 010 - CALFREE or SCA01 - SOLID CAL” PRODUCT SUPPLIED BY THE PRODUCER.

NEVER USE GENERIC ANTI-LIMESCALE OR DESCALING PRODUCTS.

10.2 • INSTALLING OVENS WITH CALOUT DEVICE (SEE CHAPTER 9)

- Place the tank of the anti-limescale “**Calfree**” with the **GREEN** cap (supplied with the oven) on the right side of the oven.
- Insert the little hose with the **GREEN** cap that comes with the oven and is marked with the **CALOUT** label (**see the connection on the right side of the oven**) until it touches the bottom of the tank and close the cap tightly.

IMPORTANT:

The manufacturer to avoid connection errors and tank exchange or confusion has provided the following features:

- The cap of the tank containing the anti-limescale product “**Calfree**” for the oven **CALOUT** system is **GREEN** coloured.
- The cap of the tank containing the alkaline detergent “**Combiclean**” (intended for the washing system) for the oven is **YELLOW** coloured.

In any case, the tanks containing the anti-limescale “Calfree” and the “Combiclean” detergent are marked with labels bearing products name, specifications and instructions for use.

11 • VENTS

11.1 • Under no circumstances must vents A and B be shut, blocked or ducted into other pipes.

A - Vent to extract vapours from the oven

B - Safety vent

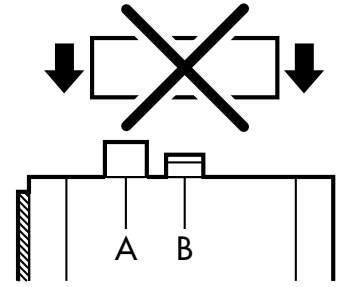

12 • GAS CONNECTION PROCEDURES

12.1 • GAS CONNECTION

The section of the gas supply pipe must be chosen according to the type of gas and the consumption of the appliance to be connected. The system must be designed and installed in accordance with current regulations. **The gas connection on the oven is R 1/2" or R 3/4", and this section must never be reduced.**

A fast acting shutoff valve must be installed on the gas inlet line to the oven. The valve must be type test approved in accordance with current regulations.

The connection to the gas main can be permanent or detachable; if flexible metal tube is used, this should be made of a stainless and corrosion resistant material.

If when making the connection you use any sealing materials, they must be type test approved for this purpose.

12.2 • LEAK TEST

All connections between the mains and the appliance must be tested for leakage. The recommended method is to use a proprietary leak detection spray; alternatively, a non-corrosive foamy liquid of any general description can simply be brushed onto the fittings: whichever method is used, no bubbles should appear.

Never under any circumstances test for gas leaks with a naked flame!

12.3 • EXHAUSTING FLUE GASES

Model 7 GN 1/1 - 6 x 600x400

Since this appliance due to its capacity has installation type A3, it is not necessary to connect it to a stack for extracting the flue gases. The flue gases can be exhausted into the installation room. Proper and continuous aeration is essential!

Remaining models

As these ovens have a power rating of >14 kW, type B installation is required. The installer must select one of the methods described below, according to the design of the building and of the room where the appliance is sited. The diameter of the flue pipes must be as indicated in the installation diagrams.

Warning:

flue gases may reach temperatures of 400 °C!

Fumes must never be ducted away utilizing an extraction system!

Clear the gas supply system of any machining debris before connecting the oven!

For UK market can be used when replacing similar equipment in kitchens where installation of the air inlet/extraction was prior to September 2001 & providing there is a documented risk assessment to ensure that there will always be sufficient make-up air and extraction available when running the equipment. Please observe Current Gas Regulations (BS 6173). Advised B23 installation due to interlocking regulations.

12 • GAS CONNECTION PROCEDURES

Installation type B13

Extraction with natural draught **fitted with a damper** and a heat-resistant pipe (see “Flue gas temperatures” in Table 4 under the heading “*Technical Data*”) connected to the stack. Selecting this type of installation the oven must be fitted with a damper that is specific for each oven (as shown in the drawing). If the oven is equipped with an adaptor collar for standard size flue pipes, fit the adaptor. Never under any circumstances must flue gases be ducted away directly utilizing a mechanical extraction system.

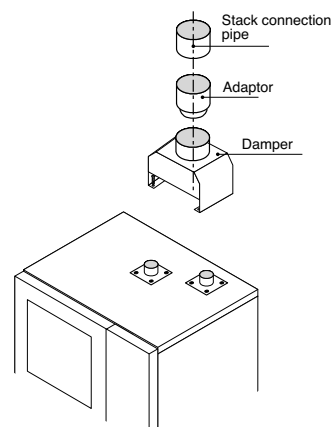

Installation type B23

Flue gases are exhausted mechanically through a suction hood with a heat-resistant filter or a ducted ceiling, **without a damper being fitted**, and either conveyed into a stack or released directly to the atmosphere together with other fumes extracted from the room. Leave a suitable distance between the oven’s smoke outlet and the hood filter or the top intake.

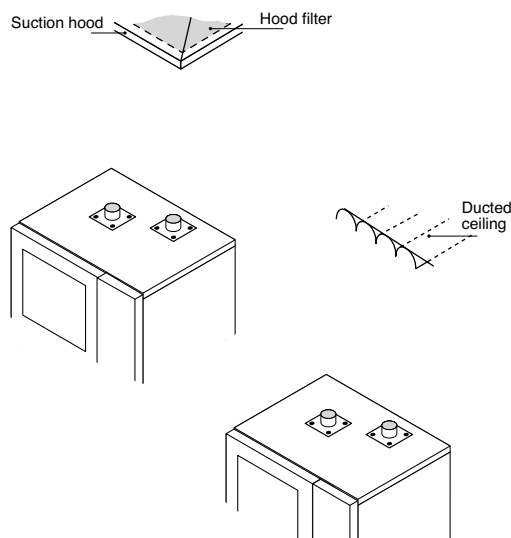

Where extraction systems are selected for type B23 installations, these must be properly sized and specified with at least one interlock device that will shut off the gas supply to the oven automatically in the event of the extractor system failing to operate.

From top of draft diverter shall end 450mm below the fat filter. The unit must be installed underneath a vented hood/ceiling. By monitoring the flue gas evacuation it must be made sure, that the supply of gas supply of the burner is only enabled in case the ventilation is ensured.

After installation, the installer must update the data plate by ticking the box, corresponding to the type of installation made, with an indelible marker pen.

A3 <input type="checkbox"/>	B13 <input checked="" type="checkbox"/>	B23 <input type="checkbox"/>
-----------------------------	---	------------------------------

The manufacturer accepts no liability for any damage or malfunctioning of the appliance attributable to the absence or inadequacy of earthing systems, to the incorrect arrangement or installation of auxiliary systems, also to incorrectly made connections or to non-compliance of the building’s electrical system with current regulations.

13 • OPERATING AT THE RATED HEAT OUTPUT

- 13.1** • All appliances, during final testing in the factory, are fitted for the type of gas shown on the sticker next to the data plate. Should the appliance fitting not correspond to the family of gases available on location, the appliance must be converted to adapt to the type of gas available. If conversion is necessary, then you must inform Customer Service and refer to the technical manual.
- 13.2** • Commissioning of the appliance to operate at the rated heat output is dependent on the inlet pressure and calorific value of the gas and the correct amount of primary air.
- 13.3** • The inlet pressure required for the appliance to operate with the various types of gas typically available will be within the limits indicated in table 6 of the “*Technical gas data*” booklet.
The appliance must not be commissioned if inlet pressure values are outside these limits. If pressures differ from those indicated in Table 6, the gas supply company or agency should be contacted, or alternatively the contractor by which the system was installed in the building.
- 13.4** • The lower calorific value of the gas can be checked with the supply company or agency, and should comply with the information given in table 5 of the “*Technical gas data*” booklet.
- 13.5 • MEASURING THE INLET PRESSURE**
The inlet pressure is measured using a manometer connected to the pressure tap (3) of the gas adjustment valve. To gain access to the valve, the right-hand side casing panel has to be removed.
Before connecting the manometer it is necessary to loosen the screw sealing the pressure tap (3). You then measure the pressure with the burner in operation. The value shown on the manometer must come within the limits given in table 6 “of the “*Technical gas data*” booklet.
After checking, carefully close the screw (3). The sealed screws you can see on the valves must never be tampered with under any circumstances.
Tampering immediately invalidates warranty!

Warning!

The gas system components are fitted for a maximum pressure of 65 mbar. Higher working pressures are not permissible.

13 • OPERATING AT THE RATED HEAT OUTPUT

CHECKING NOMINAL HEAT CAPACITY

SAGB.... - SAGV.... - ARGS....

- Chamber Burner

Check the depth of the screw “A” in accordance with **table 5** of the “*Technical gas data*” booklet, using a gauge.

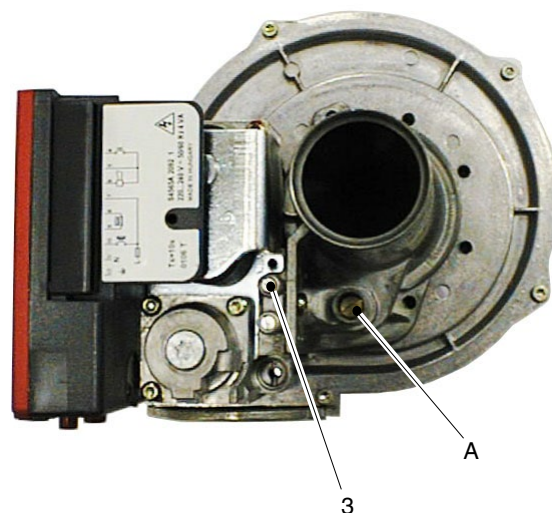

Check that the burner fan speed, corresponds to the data given in **table 5** of the “*Technical gas data*” booklet.

To enter the management screen of the burner to check:

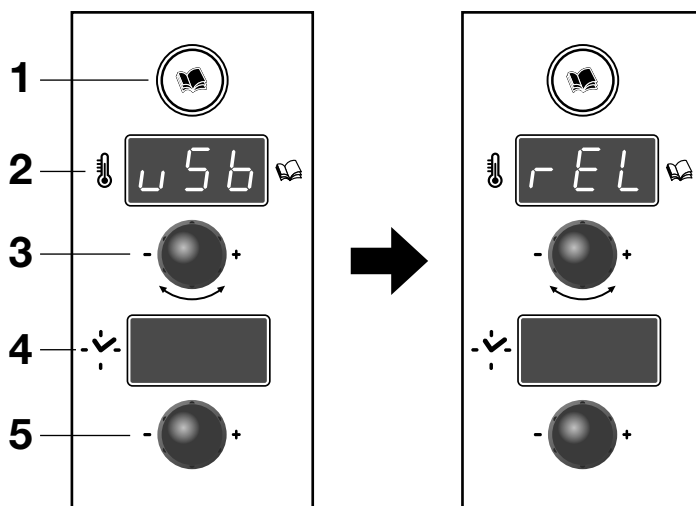

With the appliance live and display off, press button **1**, the display **2** shows [USb], turn knob **3** until [rEL] is displayed, press the knob to confirm the selection

Turn knob **3** to set the password for parameter modification and confirm by pressing knob **3**.

13 • OPERATING AT THE RATED HEAT OUTPUT

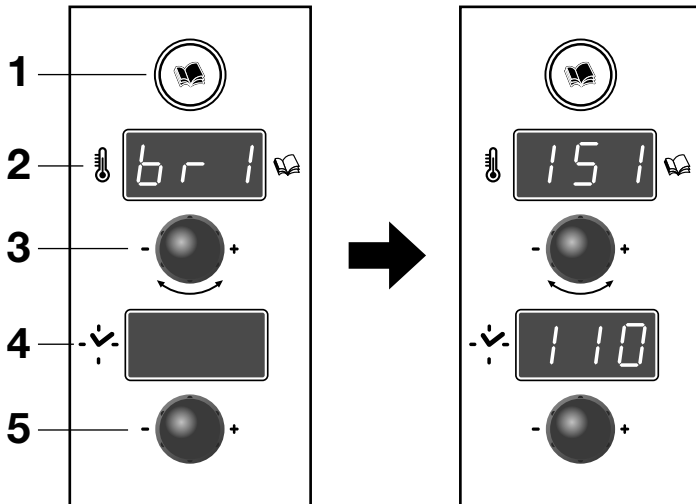

Turn knob **5** until **[br1]** on display **2** and confirm by pressing knob **3**.

display **2** shows parameter **[151]** IGN ignition speed and display **4** shows the ignition speed value (example **[110]**).

To modify the value press knob **5**, turn to knob **5** to set the new value and confirm by pressing knob **5**.

Turning knob **3** takes us to display **2** visualisation of parameter **[152]** minimum speed, and display **4** shows the minimum speed value (example **[136]**).

Turning knob **3** again takes us to display **2** visualisation of parameter **[153]** maximum speed, and display **4** shows the maximum speed value (example **[173]**).

Press button **1** to select another burner by turning knob **5**.

Proceed in the same way to check the values of the other burners if present (example **[br2]**).

13 • OPERATING AT THE RATED HEAT OUTPUT

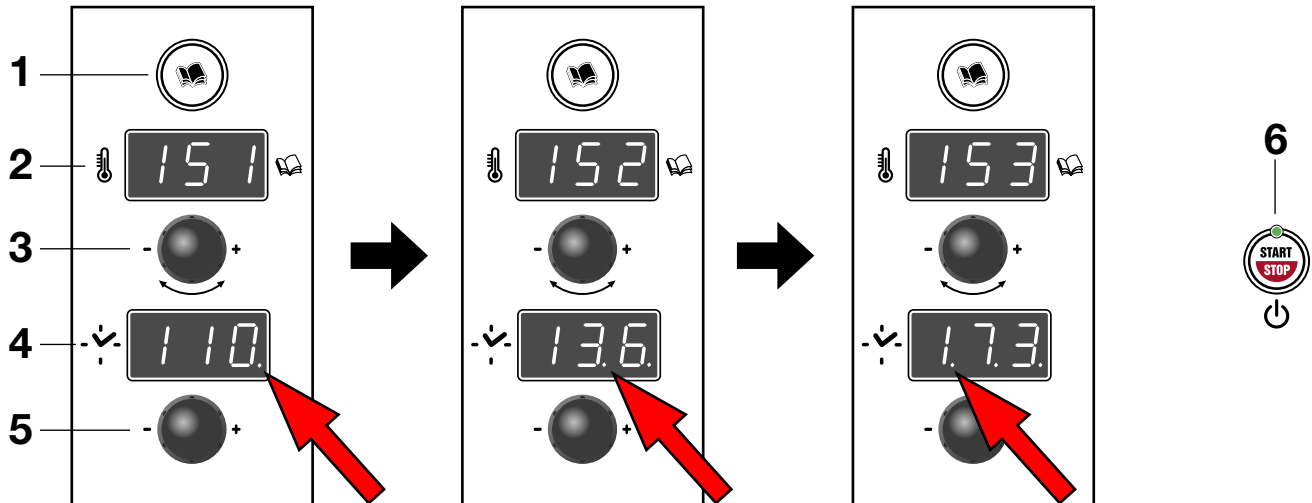

Then, to test the correct functioning of the burners, exit the screen by pressing **1**.

To test chamber burner [**br1**], turn scroller **5** until [**br1**] on display **2**, and then start-up the cycle with the **6** "START/STOP" button.

The burner will go in pre-ventilation to then pass on to the set IGN ignition. The first IGN ignition stage is indicated on display **4**, by the first point under the speed value.

Then, the minimum and maximum speed stages, indicated respectively in the second and third points, will automatically activate.

The correct burner functioning is highlighted by the increase of the temperature in the cooking compartment.

To deactivate burner functioning, press button **6** "START/STOP" again.

To exit the cycle press button **1**.

NOTE: To check/adjust the boiler burner, activate the Boiler Burner section (example [**br2**]) as operated for cooking compartment burner heating.

During testing, it is possible to manually block the sequence by pressing button **1**; this way, the burner blocks in the desired phase (ex. IGN ignition) allowing the technician to carry out other verifications in this phase.

When a phase is blocked, the point indicating phase 1, 2 or 3 flashes.

To restart the sequence, always press button **1**.

NOTE: in case of maximum speed, the cycle block becomes pointless since the oven is already working normally; it is possible to shift to minimum phase by pressing key **1**.

To carry out the tests with the door open, once the cycle is started, press the "CLIMA" button; this function is useful during combustion analysis and for functioning tests of the prolonged burner without reaching the temperature previously set in the chamber.

13 • OPERATING AT THE RATED HEAT OUTPUT

CHECKING NOMINAL HEAT CAPACITY

SAGB....R - SAGV....R - ARGV....R

- Chamber Burner

Check the depth of the screw “A” in accordance with **table 5** of the “*Technical gas data*” booklet, using a gauge.

Check that the burner fan speed, corresponds to the data given in **table 5** of the “*Technical gas data*” booklet.

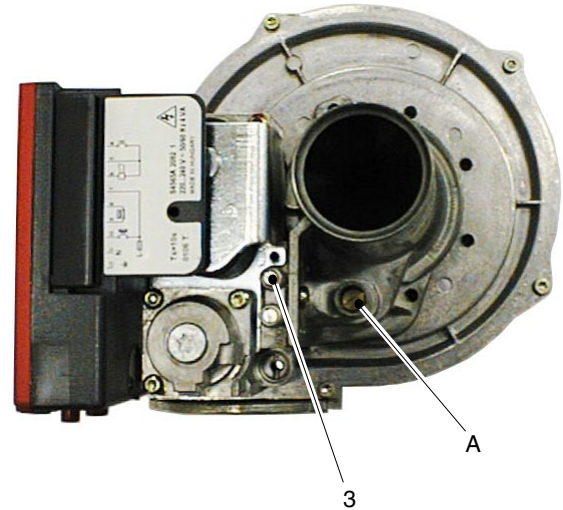

To enter the management screen of the burner to check:

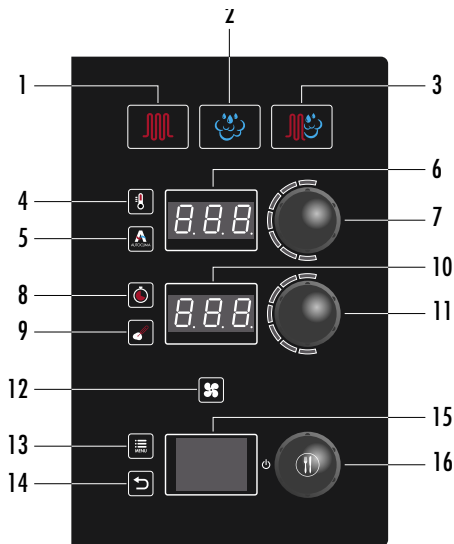

Press the MENU button **13**, turn knob **16** until “Settings” is displayed and confirm by pressing knob 16.

Select “Gas” and press knob **16** to confirm. Turn knob **16** to set the password for parameter modification and confirm by pressing the knob **16**.

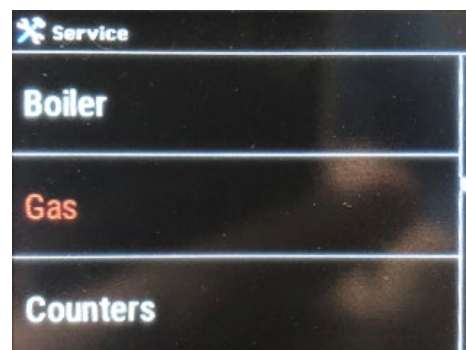
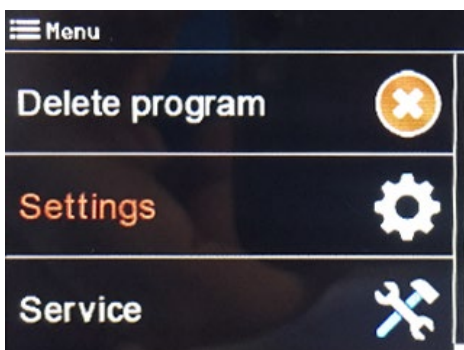

13 • OPERATING AT THE RATED HEAT OUTPUT

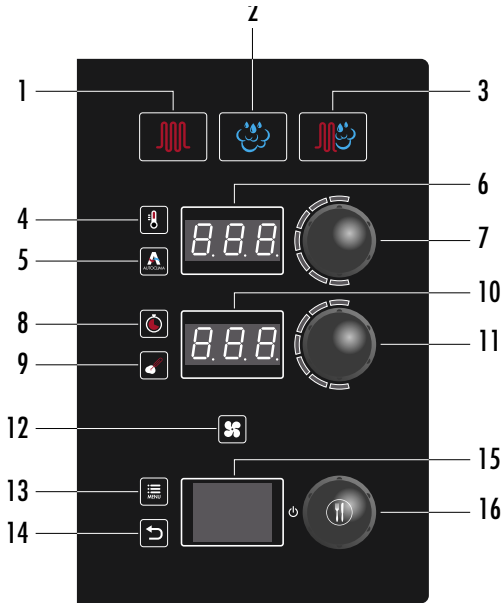

Select the burner, by turning knob **16** and confirm by pressing knob **16**.

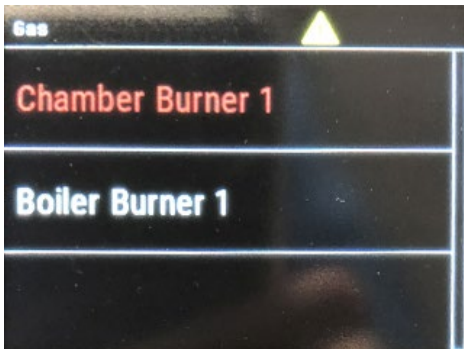

Set the new value, by turning knob **16** and confirm by pressing knob **16**.



To change a value, highlight it by turning knob **16** and confirm by pressing knob **16**.

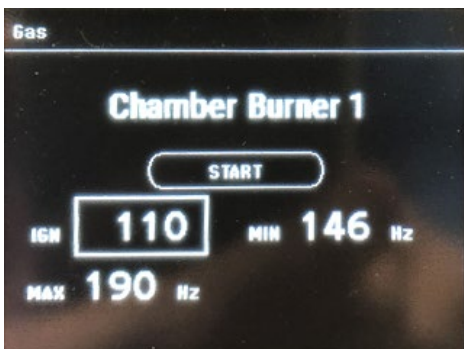

Proceed in the same way to change the values of the other burners if present (example "Chamber burner 2").

13 • OPERATING AT THE RATED HEAT OUTPUT

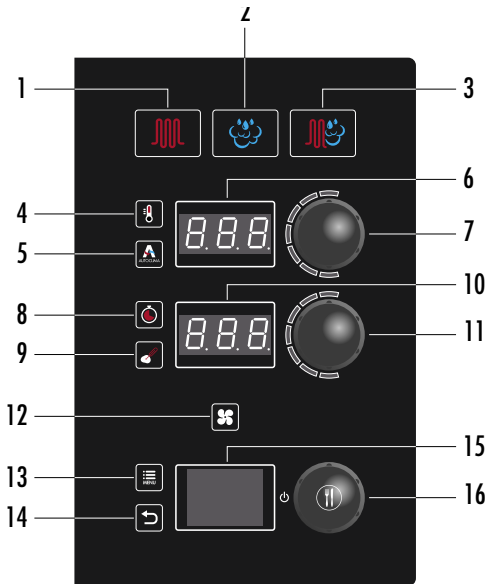

Then, to test the correct functioning of the burners, select “start” by turning knob **16** and confirm by pressing knob **16**.

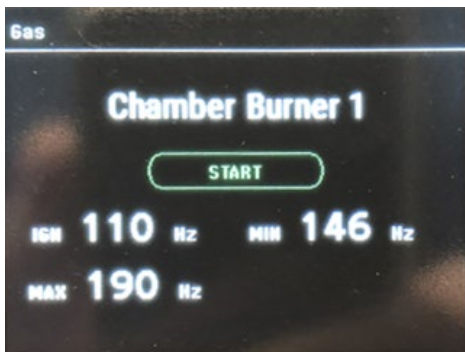

The burner will go in pre-ventilation to then pass on to the set IGN ignition. The first IGN ignition stage is indicated on display **10** by the first point under the speed value.

Then, the minimum and maximum speed stages, indicated respectively in the second and third points, will automatically activate.

The correct burner functioning is highlighted by the increase of the temperature in the cooking compartment.

To deactivate burner functioning, press “STOP”, displayed on the display **15**.

To exit the cycle press button **14**.

NOTE: To check/adjust the boiler burner, activate the Boiler Burner section (example “Boiler burner 1”) as operated for cooking compartment burner heating.

During testing, it is possible to manually block the sequence by pressing “MENU” **13**; this way, the burner blocks in the desired phase (ex. IGN ignition) allowing the technician to carry out other verifications in this phase.

When a phase is blocked, the point indicating phase 1, 2 or 3 flashes.

To restart the sequence, always press “MENU” **13**.

NOTE: in case of maximum speed, the cycle block becomes pointless since the oven is already working normally; it is possible to shift to minimum phase by pressing “MENU” **13**.

To carry out the tests with the door open, once the cycle is started, press the “CLIMA” button **5**; this function is useful during combustion analysis and for functioning tests of the prolonged burner without reaching the temperature previously set in the chamber.

13 • OPERATING AT THE RATED HEAT OUTPUT

Check the combustion, **CO (ppm)** and **CO₂ (%)** values, with an appropriate instrument. Start the oven working, with the door open, and wait for approximately 5 minutes. Position the flue gas collection probe in the flue gas outlet pipe (chamber and boiler).

The **CO₂** must be for:

Natural gas **between 9% and 10.5%**

L.P.G. **between 9% and 13%**

The **CO** must be no greater than **300 ppm** (measured).

If these readings are outside the ranges, proceed as stated in the technical manual.

For the conversion from natural gas to LPG, or vice versa, proceed as described in the technical manual.

- Boiler Burner

Repeat these operations, setting 130°C steam cooking (also with door closed).

Conversion: As mentioned above, every appliance is factory set to burn the type of gas specified, it may become necessary nonetheless to convert the appliance from one type of gas to another. Therefore, only personnel authorized by the company and belonging to the technical service who have the corresponding technical handbook can do this work.

13 • OPERATING AT THE RATED HEAT OUTPUT

CHECKING NOMINAL HEAT CAPACITY

NAGB.... - NAGV.... - ARGN....

NAGB....R - NAGV....R - ARGN....R

Check the depth of the screw “A” in accordance with **table 5** of the “*Technical gas data*” booklet, using a gauge.

Access the settings page for the burner to be checked:



Check that the burner fan speed, corresponds to the data given in table 5 of the “*Technical gas data*” booklet.

Set 180°C convection cooking, operating with “MIN” and “MAX” speeds and with the doors open.

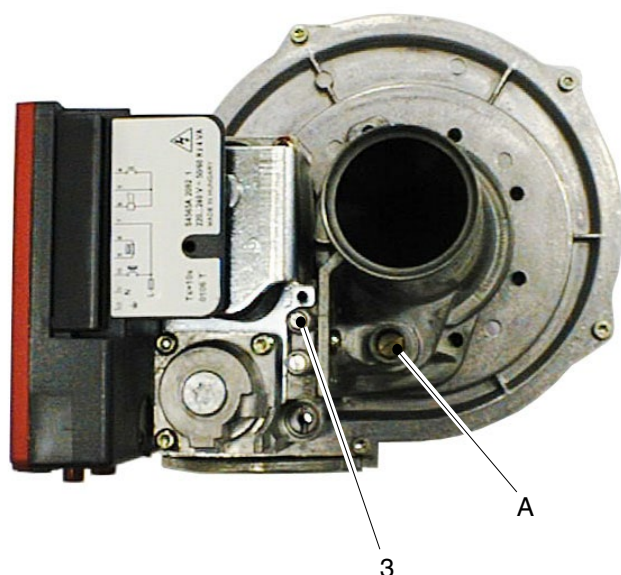

Check the combustion, **CO (ppm)** and **CO2 (%)** values, with an appropriate instrument. Start the oven working, with the door open, and wait for approximately 5 minutes. Position the flue gas collection probe in the flue gas outlet pipe (chamber and boiler).

The **CO2** must be for:

Natural gas between 9% and 10.5%

L.P.G. between 9% and 13%

The **CO** must be no greater than **300 ppm** (measured).

If these readings are outside the ranges, proceed as stated in the technical manual.

For the conversion from natural gas to LPG, or vice versa, proceed as described in the technical manual.

- Boiler Burner

Repeat these operations, setting 130°C steam cooking (also with door closed).

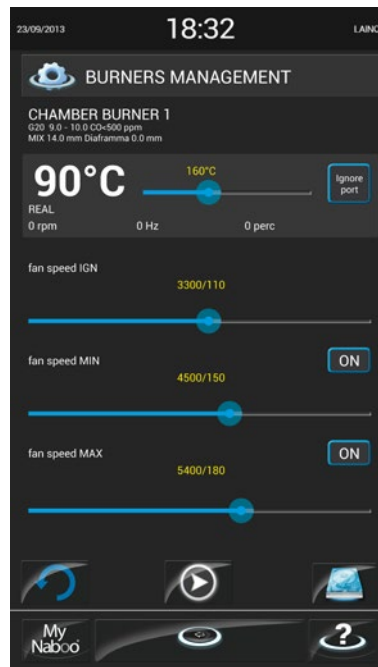

Conversion: As mentioned above, every appliance is factory set to burn the type of gas specified, it may become necessary nonetheless to convert the appliance from one type of gas to another. Therefore, only personnel authorized by the company and belonging to the technical service who have the corresponding technical handbook can do this work.

14 • COMMISSIONING AND TESTING

- 14.1** • Check the appliance and the entire installation straight after connecting. Check in particular:
- there are no traces of the protective film on the outside walls and the oven is empty;
 - all the vents are clear;
 - the connections are made as required and instructed in this handbook;
 - all the safety requirements of the current standards, laws and directives are met;
 - there is no leakage from the gas and water connections;
 - water drainage and flue gas extraction are clear.
- Apply the adhesive with the warning signal against the scalding danger at a height from the ground of 1.6m.

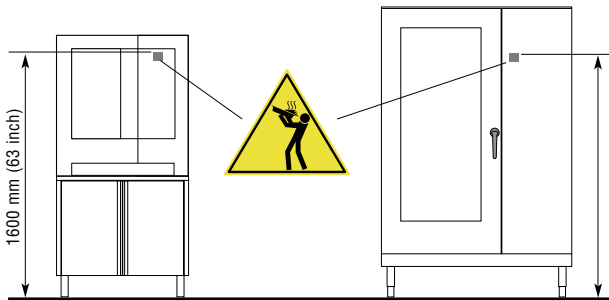

- 14.2** • Now proceed to light the oven as directed in the user manual, checking the smooth ignition of the burner.
- 14.3** • You should moreover check that the silicone joints and sleeves of the water circuit (oven vent, oven outlet, drip tray) do not leak.
- 14.4** • For equipment with automatic washing system with drawers. Follow the generation of detergent/descaler.
- 14.5** • Carefully refit the right-hand side that was removed for the above work.
- 14.6** • For additional certainty that the appliance is operating correctly, carry out a volumetric measurement of the quantity of gas consumed. The meter will show how much gas has been consumed over a given period of time, and this value can be checked against the values given in Table 5 of the “*Technical gas data*” booklet.
- 14.7** • The test report must be completed in all its parts, registered on the “service-planner” technical portal and submitted to the Client, who must sign it for acceptance. This operation automatically starts the oven warranty period.
- 14.8** • **ATTENTION:** Upon installation, we recommend updated the oven software to the latest version.

15 • IMPORTANT INFORMATION FOR THE USER

- 15.1** • With the user manual to hand, show the user the functions, safety devices, appropriate use and, above all, the time intervals for servicing the oven. Maintenance operations include cleaning the burners, inspecting the combustion chamber and cleaning the various ducts and pipes, and should be carried out at least once a year. With this in mind, customers are recommended to sign a service agreement.
- 15.2** • **Ensure the user is fully aware that such repair and/or maintenance operations as may become necessary over time must be carried out only by an authorized service agent.**
- 15.3** • Explain clearly to the user that in the event of breakdown or faulty operation, all connected utilities (water, electricity and gas) should be shut off immediately.
- 15.4** • Keep the installation manual and the wiring diagram for future reference.
Explain to the user that the user manual supplied with the oven must be kept near the oven in a place where it can be seen. It is good policy to make a note, in the user manual, of the name and contact numbers of the selected Service Agent.
- 15.5** • Explain to the user that certain faults in operation are often due to simple errors or oversights such as failure to switch on or connect utilities. Accordingly, kitchen staff should be trained in such a way that they can use the appliance confidently and understand how it operates.
Faults of a recurring or persistent nature must be investigated by an authorized Service Agent.
- 15.6** • Explain clearly that any alterations to the room or changes in ventilation may affect the operation of gas-fired appliances. In these cases, it is advisable to have the oven functions checked over.

16 • DISMANTLING AND DISPOSAL

“Implementation of Directives 2002/95/EC, 2002/96/EC and 2003/108/EC relating to the use of hazardous substances in electrical and electronic equipment, as well as waste disposal.”

161 • DISPOSAL

The barred bin symbol on the equipment indicates that at the end of its useful life it must be collected separately from other waste.

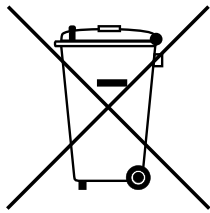

16.2 • The user must therefore dispose of the equipment at the end of its useful life at the appropriate centres for the separate collection of electronic and electrical waste, or return it to the dealer when purchasing a new equivalent product, on a one to one basis.

16.3 • Proper separate collection for subsequent recycling treatment and environmentally friendly disposal of the equipment helps prevent possible negative effects on health and the environment and promotes the recycling of the materials that make up the equipment.

16.4 • Illegal dumping of the product by the user will result in the application of administrative sanctions according to the current law.

17 • INSTALLATION DIAGRAMS

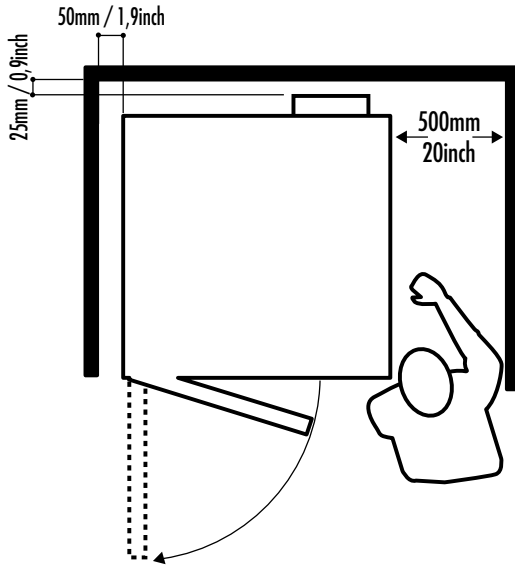

DISTANCES TO OBSERVE

Keep a distance of 500mm/20inch on the right-hand side in order to carry out maintenance work.

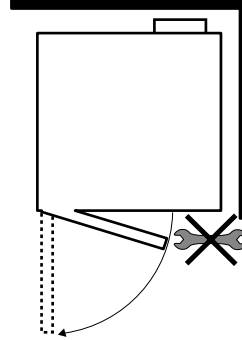

For installations different to those described, consult the manufacturer/distributor of the appliance.

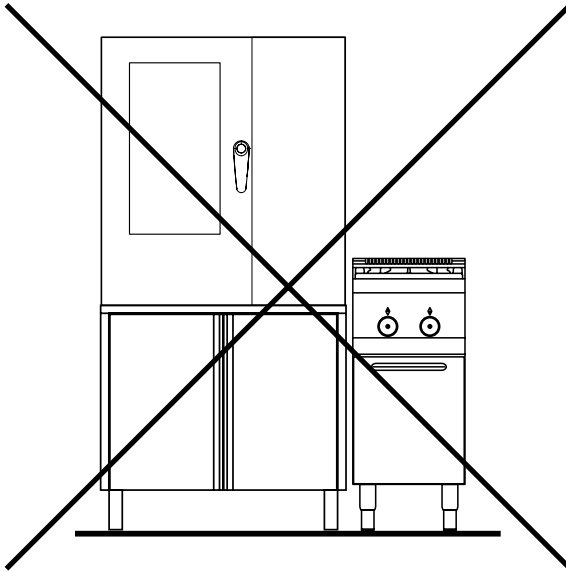

CAUTION: if the ambient temperature to the right of the appliance is too high, the oven will stop for reasons of safety.

DO NOT INSTALL APPLIANCES WITH A SOURCE OF HEAT ON THE RIGHT-HAND SIDE OF THE OVEN

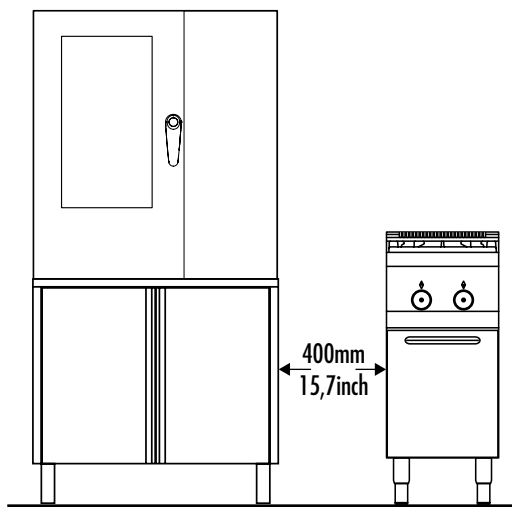

Minimum distance from sources of heat on the right-hand side: 400mm/15,7mm.

LA90027911 MANUALE INST. NAB00/SAPIENS/AROMA - EN

