

Microwave combination oven

Part number: 32Z9170

 **Read instructions before use**

Models: **50Hz & 60Hz**

Language: **ENGLISH**

Expanding your Opportunities

Section no.		Page no.
1	General information	4
1.1	Declaration of conformity	4
1.2	Environmental protection	4
1.3	Important information	4
1.4	Identifying your microwave combination oven	5
1.5	About this service and repair manual	6
2	For your safety	7
2.1	Basic safety code	7
2.2	Requirements to be met by personnel and working positions	8
2.3	Personal protective equipment	8
2.4	Intended use of the microwave combination oven	10
2.5	Warning signs on the microwave combination oven	11
2.6	Safety devices	12
2.7	Summary of hazards	13
2.8	Hazards and safety precautions when setting up the appliance, during installation, preparing the appliance for use and cleaning	13
2.9	Safe working when working on the appliance	14
2.10	Hazards and safety precautions during servicing and repair	14
2.11	Hazards and safety precautions when taking the appliance out of service	17
2.12	Safe working during electrical installation	18
2.13	Electrical installation requirements	19
2.14	Safe working when testing components	20
2.15	Process for discharging the capacitors	21
2.16	Safe working when replacing appliance parts	22
3	Technical data	24
3.1	Technical data charts	24
3.2	Dimensional drawings	31
4	Accessing the easyTouch® 2.0 screen	33
4.1	Main menu screen	33
4.2	The keyboard screen	34
4.3	Cleaning procedures	35
4.4	Using a USB stick	36
4.5	Firmware updates	37
5	Service information	41
5.1	Service procedure	41
5.2	Errors and diagnostics	42
5.3	Fault finding	49
5.4	Safe working when testing components	56
5.5	Requirements	56
5.6	Testing selected components (casing mounted)	56
(5.6)	Recommissioning test	61
5.7	High voltage components (casing removed)	65
5.8	Mains voltage components (casing removed)	67
5.9	KitchenConnect components	69
6	Replacing components	69
6.1	Safe working when replacing appliance parts	69
6.2	Overview	70

6.3	Removing / fitting the casing	74
6.4	Removing / fitting the door assembly and hinges	75
6.5	Adjusting the door microswitches/interlocks	77
6.6	Replacing the door gasket	80
6.7	Replacing a magnetron	81
6.8	Replacing the cooling fan	83
6.9	Replacing the UI (User Interface) assembly	84
6.10	Replacing the IO Board (Input Output Board)	87
6.11	PM (Personality Module) replacement	88
6.12	Replacing the stirrer motor and stirrer assembly	89
6.13	Replacing the convection fan motor	91
6.14	Replacing a transformer (high voltage)	92
6.15	Removing the convection fan motor speed controller	94
6.16	Replacing the heating element	95
6.17	Overview – further components	96
6.18	Technical data summary sheet	104
7	Circuit boards and diagrams	105
7.1	IO circuit board	105
7.2	Circuit diagrams	109
8	Annual PM check procedure for connex®	117

1.1 Declaration of conformity

Manufacturer

Authorised representative (brand headquarters)

Welbilt UK Limited
Ashbourne House, The Guildway,
Old Portsmouth Road
Guildford GU3 1LR
United Kingdom

Factory

Welbilt UK Limited
Provincial Park,
Nether Lane,
Sheffield, S35 9ZX
United Kingdom

Equipment details

Generic model number conneX® X12 & X16**Description** Commercial combination microwave oven

Declaration of conformity with directives and standards

The manufacturer hereby declares that this commercial combination microwave oven complies with the required directives and standards. Please see the Installation and User Manual for further details.

Quality and environmental management

Welbilt UK Limited (Sheffield) employs a quality management system and a certified environmental management system. Please see the Installation and User Manual for further details.

1.2 Environmental protection

Statement of principles

Our customers' expectations, the legal regulations and standards and our company's own reputation set the quality and service for all our products.

We have an environmental management policy that not only ensures compliance with all environmental regulations and laws, but also commits us to continuous improvement of our green credentials.

We have developed a quality and environmental management system in order to guarantee the continued manufacture of high-quality products and to be sure of meeting our environmental targets.

Environmental protection procedures

We observe the following procedures:

- Use of RoHS2-compliant products
- REACH chemical law
- Recycling of electronic waste
- Environmentally friendly disposal of old appliances via the manufacturer

Join us in our commitment to protect the environment.

1.3 Important information

Users are cautioned that maintenance and repairs should be performed by a Merrychef® authorised service agent using genuine Merrychef® replacement parts. Merrychef® will have no obligation with respect to any product that has been improperly installed, adjusted, operated or not maintained in accordance with national and local codes or installation instructions provided with the product, or any product that has its serial number defaced, obliterated or removed, or which has been modified or repaired using unauthorised parts or by unauthorised service agents. For a list of authorised service agents please refer to your distributor.

1.4 Identifying your microwave combination oven

Position of nameplate

The nameplate is located on the rear of your microwave combination oven.

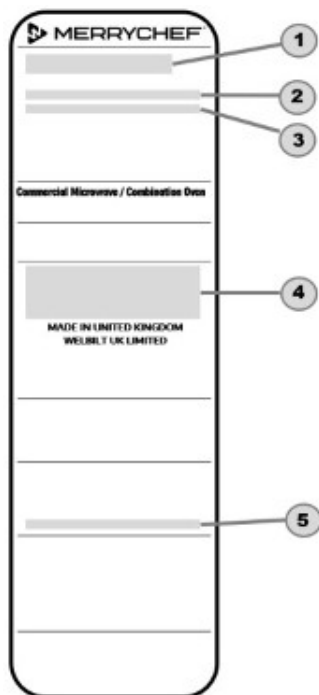

1 Model number conneX® 12 & conneX® 16

2 Item Number

Elements of the item

Elements of the item	Label	Meaning
Model	X12 or X16	
Power output convection	D	2200W
	F	2200W / 1300W
	G	2200W / 900W
	S	3200W
	B	2000W (High power version)
Power output microwave	X	1000W (Standard power version)
Voltage	MV5	220-230V / 50Hz
	MV6	208-240V / 60Hz
	00	200V
	20	220V
Frequency	5	50Hz
	6	60Hz
Lead	A - Z	Examples:A= L+N+E (1.5mm) B = L1+L2+L3+N+E (2.5mm) G = L1+L2+L3+N+E (4mm) H = L+N+E (4mm)
Plug	A - Z	Examples:A = UK 13A 3-pin C = 32A 3ph D = 16A 3ph (90°) E = 32A 1ph
Communication Version	L	USB + LAN + WiFi
	A, B	A, B (pre-production)
	1, 2, ...	1, 2, ... (serial production)
Accessory / Customer	BK	"Carbon Black" exterior
	TL	"Stainless Steel" exterior
	WW	Specific customer
Region / Country	EU	Europe
	US	United States of America

3 Serial Number

Elements of the serial number

Elements of the serial number	Label	Meaning
Year of manufacture	21	2021
	22, ...	2022, ...
Month of manufacture	01	January
	02, ...	February, ...
Place of manufacture	2130	Sheffield (UK)
Production number	12345	

4 Technical data

5 Manufacturer addresses

1.5 About this service and repair manual

■ Purpose

This service and repair manual is intended for all trained Merrychef service technicians who work with the microwave combination oven and provides them with the necessary information for carrying out servicing and repair work properly and safely.

■ Who should read the service and repair manual?

Name of target group: Merrychef trained service technicians

Tasks: All servicing and repair work

■ Parts of this document that must be read without fail

If you do not follow the information in this document, you risk potentially fatal injury and property damage.

To guarantee safety, all people who work with the microwave combination oven must have read and understood the following parts of this document before starting any work:

- Section 2 'For your safety'
- The sections that describe the activity to be carried out

■ Safety alert symbol

Symbol



Meaning



Warns of potential injuries. Heed all the warning notices that appear after this symbol to avoid potential injuries or death.

■ Form of warning notices

The warning notices are categorized according to the following hazard levels:

Hazard level	Consequences	Likelihood
 DANGER	Death / serious injury (irreversible)	Immediate risk
 WARNING	Death / serious injury (irreversible)	Potential risk
 CAUTION	Minor injury (reversible)	Potential risk
NOTICE	Damage to property	Potential risk

■ Standards

This service and repair manual has been written and produced in the UK, following UK and EU standards. Any additional local country standards, outside of the UK, must be understood and adhered to.



2 For your safety

Purpose

This chapter provides you with all the information you need in order to work with the microwave combination oven safely without putting yourself or others at risk.

This is a particularly important chapter that you must read through carefully.

IMPORTANT:

This manual provides technical guidance for technicians who have successfully undertaken a recognized product familiarization and training course run by Merrychef to carry out service/repair tasks to the appliance/s shown on the front cover of this manual which must not be used for any other make or model of appliance.

Please remember that it is wiser not to attempt a service task if you are unsure of being able to complete it competently, quickly, and above all safely.

To avoid injury to yourself or others and to protect the appliance from possible damage, ensure you have read and understand all the relevant instructions and ALWAYS follow the safety codes when servicing an oven.

1. Ensure the electrical supply is locked-off to prevent the oven from being inadvertently powered up.
2. Do not leave the oven unattended without the oven panels fitted and keep within sight of other personnel when testing the oven, ensuring persons other than trained engineers are denied access.
3. The minimum number of panels should be removed, and the high voltage capacitors must be discharged before working on the oven using a suitable capacitor discharge tool (see section 2.15).
4. Temporary insulation should be used to prevent accidental contact with dangerous conductors.
5. Do not touch any internal wiring or connectors within the oven, whether you believe it is live or not and avoid touching the metalwork (casing, panels, etc) of the oven with your body.
6. Only use electrically rated screwdrivers for adjusting 'pots' etc., ensuring the tool touches nothing else.
7. Ensure the test equipment is set correctly before use.
8. Test equipment such as meter test leads or clamps must be fitted and removed whilst the unit is dead, for each and every test.
9. Do not undertake functional magnetron testing with the panels of the casing removed.
10. Avoid touching the test equipment, unless necessary for the operation.
11. Upon completion of a service follow the steps for commissioning the oven under the 'Commissioning the appliance' section of this manual.

2.1 Basic safety code

Object of the safety code

This safety code aims to ensure that all persons who operate, install, service and repair the microwave combination oven have a thorough knowledge of the hazards and safety precautions, and that they follow the warning notices given in the connex® Installation and User manual, this Service manual and on the appliance. If you do not follow this safety code, you risk potentially fatal injury and property damage.

Referring to the connex® Installation and User manual included in the customer documentation

- Read in full this chapter 'For your safety' and the chapters that relate to your work.
- Always keep to hand the manuals included in the customer documentation for reference.
- Pass on the user manuals included in the customer documentation with the microwave combination oven if it changes ownership.

CAUTION

Warning to service technicians:

Precautions to be observed before and during servicing to avoid possible exposure to excessive microwave energy.

1. Do not operate or allow the oven to be operated with the door open.
2. Make the following safety checks on all ovens to be serviced before activating the magnetron or other microwave source, and make repairs as necessary:
 - Interlock operation.
 - Proper door closing.
 - Seal and sealing surfaces (arcing, wear, and other damage).
 - Damage to or loosening of hinges and latches.
 - Evidence of dropping or abuse.

3. Before turning on microwave power for any service test or inspection within the microwave generating compartments, check the magnetron, wave guide or transmission line, and cavity for proper alignment, integrity and connections.
4. Any defective or misadjusted components in the interlock, monitor, door seal, and microwave generation and transmission systems shall be repaired, replaced, or adjusted by procedures described in this manual before the oven is released to the owner.
5. A microwave leakage check should be performed on each oven prior to release to the owner.

2.2 Requirements to be met by personnel and working positions

Requirements to be met by operating personnel

Personnel	Qualifications	Tasks
Service technician	<ul style="list-style-type: none"> Is an authorized service agent Has relevant technical training Is trained in the particular appliance Knows the regulations associated with handling heavy loads 	All servicing and repair work

Working positions during servicing and repairs

The service area for staff during servicing and repair work is the area around the appliance.

If it is not possible to obtain full access to all sides of the appliance move it to a better location following all manual handling recommendations.

2.3 Personal protective equipment

Moving and setting up the appliance

Activity	Materials used	Personal protective equipment
<ul style="list-style-type: none"> Conveying within the establishment Setting up the appliance on a work surface, stand or in a stacking trolley. Setting up the appliance in the installation location 	<ul style="list-style-type: none"> Suitable lifting gear Forklift truck or pallet truck 	<ul style="list-style-type: none"> Protective gloves Safety boots Hard hat (e.g., when heavy loads are being lifted, working overhead, ...)

Installation, preparing for first-time use and taking out of service

Activity	Materials used	Personal protective equipment
Installing and removing (taking out of operation) the electrical connection	Tools and equipment depending on the task	Work wear and personal protective equipment depending on the job that needs doing as specified in national regulations
<ul style="list-style-type: none"> Preparing the appliance for first-time use Instructing the user 	Tools and equipment depending on the task	<ul style="list-style-type: none"> Workwear as specified in country-specific standards and directives for kitchen work, in particular: Protective clothing Heat protective gloves (compliant with EN 407 in European Union) Safety boots

Dismantling the appliance (taking out of operation)	Suitable lifting gear Forklift truck or pallet truck	Protective gloves Safety boots Hard hat (e.g., when heavy loads are being lifted, working overhead)
---	---	---

■ Operation

Activity	Materials used	Personal protective equipment
Loading / removing food	None	Workwear as specified in country-specific standards and directives for kitchen work, in particular: Protective clothing Heat protective gloves (compliant with EN 407 in European Union) Safety boots
Removing and fitting parts	Tools and equipment depending on the task	Workwear as specified in country-specific standards and directives for kitchen work, in particular: Protective clothing Heat protective gloves (compliant with EN 407 in European Union) Safety boots

■ Cleaning

Activity	Materials used	Personal protective equipment
Cleaning the cavity by hand Handling spray bottles	Cleaning chemicals approved by the manufacturer Protective chemicals approved by the manufacturer	Items of protection equipment, depending on cleaning chemical being used: Breathing mask Safety goggles Protective gloves Protective clothing/apron The EC safety datasheet for the relevant cleaning chemical contains a more precise specification of these items. An up-to-date copy can be obtained from the manufacturer. Refer to the label on the cleaning chemical concerned.
Cleaning components and accessories according to relevant instructions	Common household detergent: mild on skin, alkali-free, pH-neutral and odourless	Follow the instructions given by the manufacturer of the cleaning chemical you are using
Cleaning the outside of the appliance	Common household stainless steel cleaner or hard surface cleaner	Follow the instructions given by the manufacturer of the cleaning chemical you are using

■ Repairs

Activity	Personal protective equipment
All repair work	Work wear and personal protective equipment depending on the job that needs doing as specified in national regulations

2.4 Intended use of the microwave combination oven

The microwave combination oven must only be used for the purposes specified below:

- The microwave combination oven is designed and built solely for cooking different foodstuffs in containers approved by the manufacturer. Microwave, convection and impingement are used for this purpose.
- The microwave combination oven is intended solely for professional, commercial use.

Restrictions on use

Some materials are not allowed to be heated in the microwave combination oven:

- No dry powder or granulated material
- No highly flammable objects with a flash point of or below 275°C / 518°F, such as highly flammable oils, fats or cloths (kitchen cloths)
- No food in sealed tins or jars

Requirements to be met by personnel

- The microwave combination oven must only be operated and installed by personnel who satisfy specific requirements. Please refer to section 2.2 'Requirements to be met by personnel and working positions' for the training and qualifications requirements.
- Personnel must be aware of the risks and regulations associated with handling heavy loads.

Requirements relating to the operating condition of the microwave combination oven

Do not operate the microwave combination oven unless it has been properly transported, set up, installed and placed into operation as indicated in section 6 of the *conneX®* Installation and User manual and the person responsible for placing it into operation has confirmed this.

- The microwave combination oven must only be operated when all safety devices and protective equipment are fitted, in working order and fixed properly in place.
- The manufacturer's regulations for operation and servicing of the microwave combination oven must be observed.

Requirements relating to the operating environment of the microwave combination oven

Specified operating environment for the microwave combination oven:

- The ambient temperature lies between +4°C / 40°F and +35°C / 95°F
- Not a toxic or potentially explosive atmosphere
- Dry kitchen floor to reduce the risk of accidents

Specified properties of the installation location:

- No fire alarm, no sprinkler system directly above the appliance
- No flammable materials, gases or liquids above, on, under or in the vicinity of the appliance
- It must be possible to set up the microwave combination oven in the installation position so that it cannot tip over or slide about. The supporting surface must comply with these requirements.

Mandatory restrictions on use:

- The appliance must not be operated outdoors and not be shifted or moved during use.

Cleaning requirements

- Use only cleaning chemicals that have been approved by the manufacturer.
- High-pressure cleaners or water jets must not be used for cleaning.
- The appliance must not be treated with alkali or acid solutions or exposed to acid fumes.

2.5 Warning signs on the microwave combination oven

Warning and safety signs

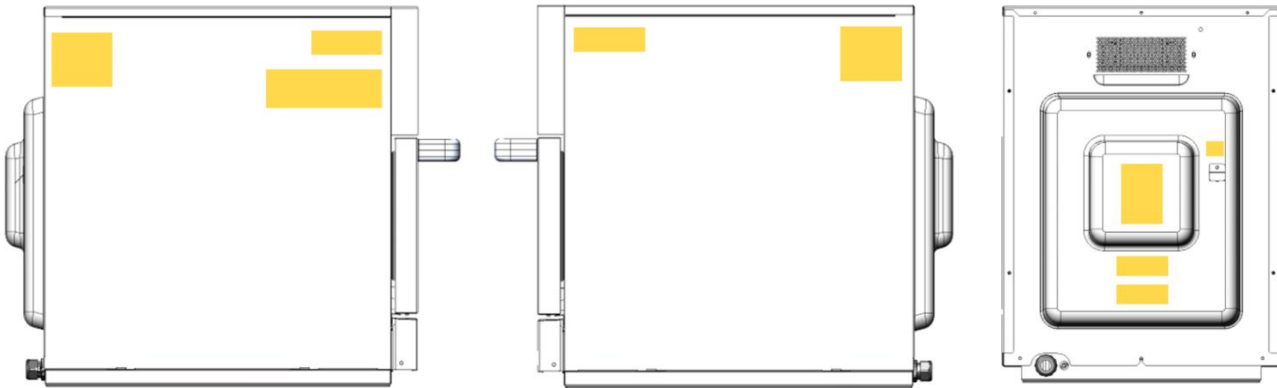







Mandatory warning signs

The following warning signs / notices must be attached to the microwave combination oven and optional accessories in the area indicated so as to be easily visible at all times.

Safety symbols

The following safety symbols be attached to the microwave combination oven in the area indicated so as to be easily visible at all times.

Area	Warning sign	Description
Side & Rear	Microwave warning. 	There is a risk of external and internal burns of body parts following exposure to microwave energy.
Side	High Voltage Electric shock warning 	There is a risk of electric shock if the appliance is serviced without disconnecting the electrical supply.
Side	Fire / electric shock warning 	There is a risk of fire / electric shock if the appliance is operated without respecting the minimum clearances.
Rear	Hot surface warning 	There is a risk of burns from high temperatures inside the cavity and on the inside of the appliance door.
Rear	High Current Electric shock warning 	There is a risk of electric shock if the electrical power is not connected to a properly grounded outlet.

Area	Safety symbol	Description
Internal		Protective Earth (Ground)
Rear		Equipotential bonding

2.6 Safety devices

Meaning

The microwave combination oven has a number of safety devices to protect the user from hazards. It is absolutely essential that all safety devices are fitted and in working order when operating the appliance.

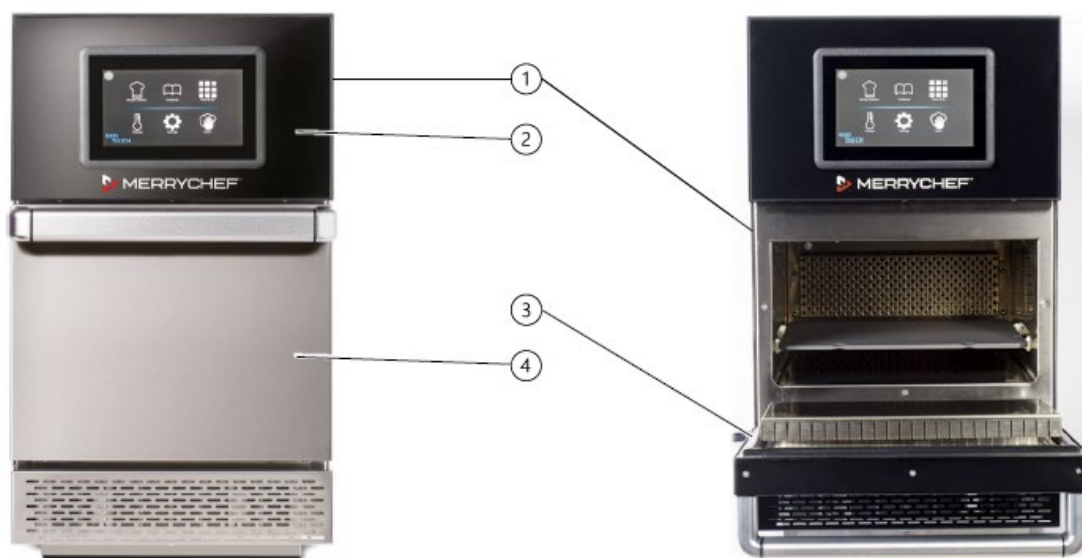

Item	Safety device	Function	Check
1	Panels can only be removed using a tool	Prevents live parts from being touched accidentally Prevents access to the moving fan from the wiring compartment	Check that the covers are in place
2	Operating panel can only be removed using a tool	Prevents live parts from being touched accidentally	Ensure that the operating panel is in place
3	Door seal	Protects the user and outside environment from steam leaking from the cavity	Check the door seal regularly for signs of damage and replace it if required
4	Appliance door	Protects the user and outside environment from hot steam and microwave energy	Check the door regularly for damage and replace it if required
5 (no picture)	Door interlocks	Ensures that the microwave generation system cannot be powered when the door is open	Check door switches: Open the appliance door fully during pre-heat or when the oven is at temperature. The Door Open message is displayed
6 (no picture, installed by customer)	Disconnection device	Installed by the customer close to the appliance; easily visible and accessible, 1- or 3-pole action, minimum contact separation 3 mm. Used to disconnect the appliance from the power supply during cleaning, repair and servicing work and in case of danger	Trip the disconnection device
7 (no picture)	Internal fuses	Prevent faulty components from drawing too much current and causing potential fire hazard.	Ensure that the internal fuses are correctly rated
8 (no picture)	Internal high temperature thermostats	Prevent faulty components from generating too much heat and causing potential fire hazard	Ensure correct operation

2.7 Summary of hazards

General rules for dealing with hazards and safety precautions

The microwave combination oven is designed to protect the user from all hazards that can reasonably be avoided by design measures.

The actual purpose of the microwave combination oven, however, means that there are still residual risks; you must therefore take precautions to avoid them. A safety device can provide you with a certain degree of protection against some of these hazards. You must ensure, however, that these safety devices are in place and in working order.

The nature of these residual risks and what effect they have are described below.

Hazard points

The following illustration shows a Merrychef connex® microwave combination oven:

Excessive microwave energy

The microwave combination oven generates microwave energy.

An operation with an open or damaged door or cavity can result in external and internal burns of body parts following exposure to microwave energy.

Heat generation (1)

The microwave combination oven becomes hot inside the cavity and on the inside of the appliance door. This poses a risk of burns on hot surfaces inside the microwave combination oven, and also on hot appliance parts, food containers and other accessories used for cooking.

Hot steam / vapour/ liquids (2)

When cooking food, the microwave combination oven may generate hot steam and vapour which escapes when the appliance door is opened, and which is removed through the air vents on the rear of the microwave combination oven when the appliance door is closed. This poses a risk of scalding from hot steam when the appliance door is opened. The operator must take particular care when opening the appliance door if the top door edge is below their field of vision.

Foodstuffs may also be liquid, or liquify during cooking. This poses a risk of scalding from hot liquids, which may be spilled if not handled properly.

Live components (3)

The microwave combination oven contains live parts. This means a risk from live parts if the cover is not in place.

Parts moving against each other (4)

For various actions, such as opening/shutting the appliance door or cleaning the appliance door, there is the risk that you will crush or cut your hand.

Contact with cleaning chemicals

The microwave combination oven must be cleaned using special cleaning chemicals. This poses a risk from cleaning chemicals, some of which can cause skin burns.



2.8 Hazards and safety precautions when setting up the appliance, during installation, preparing the appliance for use and cleaning

Please see the detailed information in section 3 'For your safety' in the connex® Installation and User manual.

2.9 Safe working when working on the appliance

■ For your safety

Before starting work, familiarize yourself with the hazards described in section 3 'For your safety' in the conneX® Installation and User manual.

■ Eligibility of personnel for working on the appliance

Only qualified Merrychef trained personnel from a Merrychef authorized service company are permitted to set up and work on the appliance.

■ Regulations for working on the appliance

Local and national standards and regulations relating to workplaces in catering kitchens must be observed.

The rules and regulations of the local authorities and supply companies that apply to the installation location concerned must be observed.

■ Personal protective equipment

Wear the personal protective equipment specified in section 2.3 'Personal protective equipment'.

■ Moving heavy loads

WARNING

Risk of injury from lifting incorrectly

When lifting the appliance, the weight of the appliance may lead to injuries, especially in the area of the torso.

- Use a forklift truck or pallet truck to place the appliance in the installation position or to move it to a new position.
- When shifting the appliance into the correct position, use enough people for the weight of the appliance when lifting it (value depending on age and gender). Observe the local occupational safety regulations.
- Wear personal protective equipment.

■ Unsuitable supporting surface

WARNING

Risk of crushing if the appliance tips over or falls off

Body parts can be crushed if the appliance tips over or falls off.

Make sure that the appliance is never placed on an unsuitable supporting surface

2.10 Hazards and safety precautions during servicing and repair

■ Safety hazard: heat

Danger	Where or in what situations does the hazard arise?	Preventative action
A risk of burns	From hot surfaces such as Racks Containers, baking sheets, shelf grills etc. Inside the entire cavity, including all parts that are or were inside during cooking On the inside of the appliance door	Before starting cleaning tasks, wait until the cavity has cooled to below 50°C / 122°F or use the 'cool down' function to cool the cavity.
		Wear specified protective clothing, in particular protective gloves.

■ Safety hazard: electrical power

 Danger	Where or in what situations does the hazard arise?	Preventative action
A risk of electric shock	Live parts: Under covers Under the control panel On the appliance and on adjacent metal parts On the appliance and on adjacent metallic accessories	Work on the electrical system must only be performed by qualified electricians from an authorized customer service company
		Before removing the covers: Switch off all connections to the power supply Take protective measures at every power switch to ensure that the power cannot be switched on again. Wait 15 minutes to allow the DC bus capacitors to discharge Make sure that the appliance is de-energized
		Make sure that the electrical connections are intact and fixed securely before plugging the appliance back into the power supply.
		Before putting the appliance back into use, make sure that the appliance, including all metallic accessories, is connected to an equipotential bonding system.

Dead working should be the normal method of carrying out work on electrical equipment or circuits. Live working should only be carried out in particular circumstances where it is unreasonable to work dead.

No person shall be engaged in any work activity on or so near any live conductor (other than one suitably covered with insulating material so as to prevent danger) that danger may arise unless;

- a) It is unreasonable in all the circumstances for it to be dead; and
- b) It is reasonable in all the circumstances for the service technician to be at work on or near it while it is live; and
- c) Suitable precautions (including where necessary the provision of suitable protective equipment) are taken to prevent injury.

When working on the oven it is important that the earthing of the power supply to the equipment is adequate and efficient. In customers' premises this is likely to be unknown, so it is important to carry out a test to demonstrate the efficacy of the earthing. The safe way to do this is to measure the earth loop impedance of the power supply using an instrument designed for that purpose. If the test indicates an inadequate earth, the customer must be informed that the work cannot continue until it has been rectified.

Simple 'Go/No go' plug-in testers will in general only provide a polarity check and an indication that an earth may be present, but not its effectiveness.

■ Safety hazard: mechanical parts of the appliance

 Danger	Where or in what situations does the hazard arise?	Preventative action
Risk of cuts from sharp edges	During servicing work When handling sheet-metal parts	Exercise caution when performing this action Wear personal protective equipment
Risk of body parts being crushed if the appliance tips over or falls off	When the appliance is being moved e.g., to gain better access to the connections	Always observe the requirements for the supporting surface

■ Safety hazard: moving heavyweights

 Danger	Where or in what situations does the hazard arise?	Preventative action
Risk of injury from overstressing your body	When moving the appliance	Use a forklift truck or pallet truck to place the appliance in the installation position or to move it to a new position Always use the correct number of persons and observe the limits specified for lifting and carrying when adjusting the appliance position Observe the local occupational safety regulations Wear personal protective equipment

■ Safety hazard: moving appliances supported on a wheeled base

 Danger	Where or in what situations does the hazard arise?	Preventative action
Risk of crushing of body parts	While appliances are being moved on a wheeled platform	When servicing, engage the parking brake on the wheels
Risk of hands and feet being pinched		
Risk of electric shock from live parts	While appliances are being moved on a wheeled platform	Disconnect the appliance from the electrical supply before moving it

■ Safety hazard: smoke or fire

 Danger	Where or in what situations does the hazard arise?	Preventative action
Risk of fire / smoke from defective electrical components or wrong electrical connections	If one of the electrical components is defect, for example due to a short circuit, or if the internal wiring is refitted incorrectly when servicing/repairing the oven	Never use electrical spare components which failed in a dedicated test or which bear visible damages Carefully refit electrical connections using the wiring diagrams provided in this manual

■ Safety hazard: electronic component damage

 Danger	Where or in what situations does the hazard arise?	Preventative action
Risk of electronic component damage within oven	The human body can store enough static electricity to damage the electronics within the oven, especially the UI & IO boards	When working on the UI, or IO, and associated wiring, anti-static precautions must be taken, such as wearing an ESD wrist strap. IMPORTANT - oven power supply and all capacitors must be proved dead first



2.11 Hazards and safety precautions when taking the appliance out of service

■ Safety hazard: electrical power

 Danger	Where or in what situations does the hazard arise?	Preventative action
A risk of electric shock	From live parts Under covers Under the operating panel	Work on the electrical system must only be performed by qualified electricians from an authorized customer service company

■ Safety hazard: moving heavyweights

 Danger	Where or in what situations does the hazard arise?	Preventative action
Risk of injury from overstressing your body	When moving the appliance onto and off the moving equipment	<ul style="list-style-type: none"> ▪ Use a forklift truck or pallet truck ▪ Do not exceed safety limits for lifting and carrying ▪ Wear personal protective equipment

■ Safety hazard: mechanical parts of the appliance

 Danger	Where or in what situations does the hazard arise?	Preventative action
Risk of body parts being crushed if the appliance tips over or falls off	When the appliance is being moved e.g., to gain better access to the connections	Ensure oven is level and stable Always observe the requirements for the supporting surface when taking the appliance out of service; see section 3 'For your safety' in the conneX® Installation and User manual
Risk of slipping on damp kitchen floor	In front of the appliance	Ensure that the floor around the appliance is dry at all times

2.12 Safe working during electrical installation

■ For your safety

Before starting work, familiarize yourself with the hazards described in section 3 'For your safety' in the conneX® Installation and User manual.

■ Eligibility of personnel for the electrical installation

Only electricians qualified under the terms of EN 50110-1 and from an authorized service company are permitted to perform work on electrical equipment.

■ Regulations for the electrical installation

Observe the following requirement to prevent hazards caused by faulty electrical connections:

- The electrical supply must be connected in accordance with applicable local and national regulations and regulations of the professional associations and of the relevant power supply company.

■ Personal protective equipment

Wear the personal protective equipment specified in section 2.3 'Personal protective equipment'.

■ Live components

DANGER

Risk of electric shock from live parts

When the appliance is not connected to an equipotential bonding system, there is a risk of electric shock from touching live parts.

- Make sure that any work on the electrical system is performed solely by a qualified electrician from an authorized service company.
- Make sure that the electrical connections are intact and connected securely before putting the appliance into use.
- Before preparing the appliance for use, make sure that the appliance, including all metallic accessories, is connected to an equipotential bonding system.

Residual-current device (RCD)	The installation regulations require protection by a residual-current device (RCD). Suitable residual-current devices meeting the relevant national regulations must be used. If the installation includes more than one appliance, one residual-current device must be provided for each appliance.
Disconnection device	An easily accessible all-pole disconnection device with a minimum contact separation of 3 mm must be installed close to the appliance. The appliance must be connected via this disconnection device. The disconnection device is used to disconnect the appliance from the electrical supply for cleaning, repair and installation work.

■ Fitted frequency-converter

The appliance is fitted with one frequency converter (FC) and EMC mains input filters.

These devices may result in a leakage current of more than 3.5 mA per FC drive. Use a suitable RCD for the rated voltage.

■ Properties of the residual-current device

The residual-current device (RCD) must have the following properties:

- Filter for filtering out RF currents
- "Time delayed" trip characteristic for RCD devices with trip threshold of 30mA*: prevents RCD being tripped by charging currents of capacitors and parasitic capacitances when appliance is switched on.
- "Leakage current protection, type SI" trip characteristic for RCD devices with trip threshold of 30mA*: insensitive to nuisance tripping.
- *Local national regulations may require lower trip ratings, such as in North America. In which case these lower trip threshold ratings must be adopted, ensuring the dedicated device has a high immunity to nuisance tripping.

Note. Residual Current Devices (RCDs) are also known by other terms, such as Earth Leakage Circuit Breakers (ELCBs), Safety Switches, Ground Fault Interrupters (GFIs) and Ground Fault Circuit Interrupters (GFCIs). These should not be confused with over current protection.

2.13 Electrical installation requirements

Circuit Breakers (MCB ~ Miniature Circuit Breakers)

For over current protection, a Type 'D' circuit breaker (designed specifically for this type of equipment) must be fitted, as a recommend alternative a higher rated type 'C' type breaker can be used (see below). Establishments with standard (Type 'B') circuit breakers are sensitive to 'surges' which occur on switching on freezers, refrigerators and other catering equipment, including microwave combination ovens. An individual, suitably rated over current circuit breaker should be fitted for each appliance installed, along with a separate dedicated Residual Current Device (Ground Fault Circuit Interrupter).

Model	Recommended Circuit Breaker (per phase)	Alternative Recommended Circuit Breaker (per phase)
conneX 12 standard power	D16	C20
conneX 12 & 16 high power 1 phase	D32	C40
conneX 12 & 16 high power 3 phase	D16	C20

Residual Current Device (RCD)

The installation regulations require protection by a Residual Current Device (Ground Fault Circuit Interrupter). Suitable residual current devices, with a high immunity to nuisance tripping, meeting the relevant national regulations must be used. As long cable runs can be a factor in nuisance tripping, they should be avoided.

If the installation includes more than one appliance, one residual-current (GFCI) device must be provided for each appliance.

Low impedance electrical supply

This commercial combination microwave oven complies with EN 61000-3-11. However, when connecting sensitive equipment to the same supply as the appliance, the user should determine in consultation with the supply authority, if necessary, that a low impedance supply is used.

Electrical supply

Illustration	Phase	Meaning
<p>SINGLE PHASE</p> <p>GREEN & YELLOW (EARTH) BLUE (NEUTRAL) BROWN (LIVE)</p>	Single phase	<p>UK 13A models are fitted with a moulded plug to BS1363, fused at 13A.</p> <p>EU 16A models are fitted with a moulded plug to CEE 7/7 (Type F Schuko) rated at 16A</p> <p>30A models are fitted with a blue 32A plug to IEC 60309 (EN 60309). Connected to a dedicated RCD (GFCI) protected supply, with appropriate circuit breaker as detailed above.</p>
<p>TWIN PHASE</p> <p>GREEN & YELLOW (EARTH) BLUE (NEUTRAL) BROWN TO LIVE No.1 BLACK TO LIVE No.2</p>	Twin phase	<p>Twin phase models should be connected as shown (the twin phase oven requires a three phase supply, utilising L1 & L2 as two separate single phases, L3 is not used).</p> <p>30A models are fitted with a red 32A plug to IEC 60309 (EN 60309).</p> <p>EU 16A models are fitted with a red 16A 90° plug to IEC 60309 (EN 60309).</p> <p>Connected to a dedicated RCD (GFCI) protected supply, with appropriate circuit breaker as detailed above.</p>
	Single phase 60Hz (two pole)	<p>Single phase models, utilising L1 & L2 split phase supply (240V) or L1 & L2 from a three phase supply (208V). Neutral is not used.</p> <p>15A models are fitted with HBL5666C NEMA 6-15P & 15A HBL4570C NEMA L6-15P plugs.</p> <p>20A models are fitted with a HBL5466C NEMA 6-20P plug.</p> <p>30A models are fitted with YP-91L NEMA 6-30P & HBL2621 NEMA L6-30P plugs.</p> <p>Connected to a dedicated RCD (GFCI) protected supply, with appropriate circuit breaker as detailed above.</p>

Please refer to electrical installation data for other country specific models.

■ Equipotential bonding

An equipotential bonding point is provided on the rear panel of the appliance for independent earth (not fitted to US models).



(GND) connection

⚠ 2.14 Safe working when testing components

■ For your safety when testing oven components

Before starting oven tests, it is essential that you familiarize yourself with the rules and hazard warning in this chapter and follow the instructions given.

■ Eligibility of personnel for testing oven components

Only qualified personnel from an authorized service company are permitted to test components of the microwave combination oven.

■ Moving heavy loads

⚠ WARNING

Risk of injury from lifting incorrectly

When lifting the appliance, the weight of the appliance may lead to injuries, especially in the area of the torso.

- Use a forklift truck or pallet truck to place the appliance in the installation position or to move it to a new position.
- When shifting the appliance into the correct position, use enough people for the weight of the appliance when lifting it (value depending on age and gender). Observe the local occupational safety regulations.
- Wear personal protective equipment.

■ Sharp-edged sheet-metal parts

⚠ WARNING

Risk of cuts from sharp-edged sheet-metal parts

Working with or behind sharp-edged sheet-metal parts may result in cuts to hands.

- Exercise caution.
- Wear personal protective equipment.

■ Hot surfaces

⚠ WARNING

Risk of burns from high temperatures inside the cavity and on the inside of the appliance door

- You may get burnt if you touch any of the interior parts of the cooking chamber, the inside of the appliance door or any parts that were inside the oven during cooking.
- Before starting servicing and repair work, wait until the cooking chamber has cooled to below 50°C / 122°F or use the 'Cool-down' function to cool the cooking chamber.
- Wear personal protective equipment.

■ Live components

⚠ DANGER

Risk of electric shock from live parts

When the appliance is not connected to an equipotential bonding system, there is a risk of electric shock from touching live parts. When the covers of the microwave combination oven are removed, there is a risk of electric shock from touching live parts.

- Make sure that any work on the electrical system is performed solely by a qualified electrician from an authorized customer service office.

Before removing the covers:

- Switch the appliance off and disconnect the plug from the wall socket.
- Turn off the isolator switch to disconnect fixed wired appliances and lock-off.
- Take protective measures at every power switch to ensure that the power cannot be switched on again.
- Always discharge the high voltage capacitors before working on the appliance using a suitable Capacitor Discharge Tool, see section 2.15 'Process for discharging the capacitors'.
- Make sure that the appliance is de-energized.
- Make sure that the electrical connections are intact, secure and all equipment panels are re-fitted before you reconnect the appliance to the power supply
- Before putting the appliance back into operation, make sure that the appliance, including all metallic accessories, is connected to an equipotential bonding system.

■ Microwave emissions

⚠ WARNING

Risk of burns from microwave emissions

- Do not become exposed to emissions from the microwave generator or parts conducting microwave energy.
- Never operate an appliance that has failed the "Microwave leakage test".

■ Fire / smoke in the appliance

⚠ WARNING

Risk of fire and/or smoke

Flames and/or smoke may come out of the oven when switching it on after service/repair. This can be caused by a defective electrical component or electrical connections (wiring) that have been refitted incorrectly.





- Switch off the oven.
- Disconnect/isolate the oven from the electrical supply.
- Keep the oven door closed to stifle any flames.

2.15 Process for discharging the capacitors:

■ Tools required

- Capacitor discharge probe
- Insulated gloves
- Voltage tester — checker

■ Process for carrying out modification / change:

		<p>Cool down the oven then isolate from the mains supply by disconnecting the plug and fitting a suitable 'locking off' device or locking in the off position the isolation switch if the oven is hard wired. Ensure your proprietary voltage tester is working correctly and prove the mains supply is dead</p>
	<p>Wait 5 Minutes to allow the capacitor to naturally discharge its energy. It is recommended that you stand on electrically safe matting where possible.</p> <ul style="list-style-type: none"> ▪ Remove the lid and side panels to access the oven components ▪ Connect the capacitor discharge probe's earth clip to the equipotential bonding point / casing at the rear of the oven 	
	<p>Hold the probe against the HV capacitor terminal for 5 seconds, removing any covers to do so. Repeat on the other set of terminalson the same capacitor. Repeat this process on both HV capacitors for equipment with two magnetrons.</p> <p>Note: the above picture shows the Merrychef approved capacitor discharge tool</p>	



Re-test your proprietary voltage tester is working correctly and test to ensure the capacitor is discharged (dead) at the magnetron(s) and the HV transformer(s).

CAUTION: To ensure safety, this must be repeated every time the oven is worked on.

Note: This is a generic HV capacitor discharge procedure for the complete range of Merrychef equipment

2.16 Safe working when replacing appliance parts

For your safety when replacing appliance parts

Before starting service / repair work, it is essential that you familiarize yourself with the rules and hazard warning in this chapter and follow the instructions given.

Eligibility of personnel for removal / fitting of appliance parts

Only qualified personnel from an authorized service company are permitted to remove and fit components of the microwave combination oven.

Rules for setting up the appliance safely

To prevent hazards that arise from the installation site and environment of the appliances, the rules for setting up the appliance safely must always be observed; see section 5 'Setting up the appliance' in the conneX® Installation and User manual.

DANGER

Risk of electric shock from live parts.

When the appliance is not connected to an equipotential bonding system, there is a risk of electric shock from touching live parts. When the covers of the microwave combination oven are removed, there is a risk of electric shock from touching live parts.

- Make sure that any work on the electrical system is performed solely by a qualified electrician from an authorized service company.
- Before removing the covers:
 - Switch the appliance off and disconnect the plug from the wall socket.
 - Turn off the isolator switch to disconnect fixed wired appliances and lock-off.
 - Take protective measures at every power switch to ensure that the power cannot be switched on again.
 - Always discharge the high voltage capacitors before working on the appliance using a suitable capacitor discharge tool. See how to discharge the conneX oven in section 2.15 'Process for discharging the capacitors'.
- Make sure that the electrical connections are intact and connected securely before putting the appliance into use.
- Before preparing the appliance for use, make sure that the appliance, including all metallic accessories, is connected to an equipotential bonding system.

Moving heavy loads

WARNING

Risk of injury from lifting incorrectly.

When lifting the appliance, the weight of the appliance may lead to injuries, especially in the area of the torso.

- Use a forklift truck or pallet truck to place the appliance in the installation position or to move it to a new position.
- When shifting the appliance into the correct position, use enough people for the weight of the appliance when lifting it (value depending on age and gender). Observe the local occupational safety regulations.
- Wear personal protective equipment.

Sharp-edged sheet-metal parts

WARNING

Risk of cuts from sharp-edged sheet-metal parts.

Working with or behind sharp-edged sheet-metal parts may result in cuts to hands.

- Exercise caution.
- Wear personal protective equipment.

Hot surfaces

WARNING

Risk of burns from high temperatures inside the cavity and on the inside of the appliance door.

- You may get burnt if you touch any of the interior parts of the cooking chamber, the inside of the appliance door or any parts that were inside the oven during cooking.
- Before starting servicing and repair work, wait until the cooking chamber has cooled to below 50°C / 122°F or use the 'Cool-down' function to cool the cooking chamber.
- Wear personal protective equipment.

Microwave emissions

WARNING

Risk of burns from microwave emissions.

- Do not become exposed to emissions from the microwave generator or parts conducting microwave energy.
- Never operate an appliance that has failed the "Microwave leakage test".

Fire / smoke in the appliance

WARNING

Risk of fire and/or smoke.

Flames and/or smoke may come out of the oven when switching it on after service/repair. This can be caused by a defective electrical component or electrical connections (wiring) that have been refitted incorrectly.

- Switch off the oven.
- Disconnect/isolate the oven from the electrical supply.
- Keep the oven door closed to stifle any flames.

3 Technical data

3.1 Technical data charts

Dimensions and weights

Width				
conneX12 including packaging	520	[mm]	20.5	[in]
conneX16 including packaging	620	[mm]	24.4	[in]
Appliance (X12) without packaging	356	[mm]	14	[in]
Appliance (X16) without packaging	459	[mm]	18.1	[in]
Height				
conneX12 including packaging	855	[mm]	33.7	[in]
conneX16 including packaging	855	[mm]	33.7	[in]
Appliance (X12) without packaging	619	[mm]	24.4	[in]
Appliance (X16) without packaging	619	[mm]	24.4	[in]
Depth				
conneX12 including packaging	820	[mm]	32.3	[in]
conneX16 including packaging	820	[mm]	32.3	[in]
Appliance (X12) without packaging, door closed	641	[mm]	25.2	[in]
Appliance (X16) without packaging, door closed	683	[mm]	26.9	[in]
Weight				
conneX12 high power version, including packaging	68.7	[kg]	151	[lbs]
conneX16 high power version, including packaging	79.2	[kg]	175	[lbs]
conneX12 high power version, excluding packaging	58.7	[kg]	130	[lbs]
conneX16 high power version, excluding packaging	67.2	[kg]	148	[lbs]
conneX12 standard power version, including packaging	60.0	[kg]	133	[lbs]
conneX12 standard power version, excluding packaging	50.0	[kg]	111	[lbs]
Safety clearances				
Right / Left	0	[mm]	0	[in]
Top / Rear (for ventilation)	50	[mm]	2	[in]

Electrical connected load ratings – X12 High power version

Electrical supply		1N~ 220-230V 50Hz	2N~ 380-400V 50Hz	1N~ 220V 60Hz	2~ 200V 50/60Hz
Connections used		L + N + E	L1 + L2 + N + E	L + N + E	2P + E
Arrangement		Single phase	Twin phase	Single phase	Two pole
Max power input	[W]	6000	2500 + 3300	6000	6000
Rated current per phase	[A]	32	16 / 32	32	32
Power output					
Rated power output convected heat	[W]	2200	2200	2200	2000
Rated power output microwave (IEC 705) 100%	[W]	2000	2000	2000	2000
Rated power output combination mode	[W]	2200 + 2000	2200 + 2000	2200 + 2000	2200 + 2000

■ Electrical connected load ratings – X12 Standard power version

Electrical supply		1N~ 220-230V 50Hz	1N~ 220-230V 50Hz	1N~ 220V 60Hz	2~ 208V 60Hz
Connections used		L + N + E	L + N + E	L + N + E	2P + E
Arrangement		Single phase	Single phase	Single phase	Two pole
Max power input	[W]	2990	3680	2990	4500
Rated current per phase	[A]	13	16	13	20
Power output					
Rated power output convected heat	[W]	2200	2200	2200	2200
Rated power output microwave (IEC 705) 100%	[W]	1000	1000	1000	1000
Rated power output combination mode (convected heat + microwave)	[W]	900 + 1000	1300 + 1000	900 + 1000	1300 + 1000

■ Electrical connected load ratings – X16 High power version

Electrical supply		1N~ 220-230V 50Hz	2N~ 380-400V 50Hz	1N~ 220V 60Hz	2~ 200V 50/60Hz
Connections used		L + N + E	L1 + L2 + N + E	L + N + E	2P + E
Arrangement		Single phase	Twin phase	Single phase	Two pole
Max power input	[W]	6000	2500 + 3300	6000	6000
Rated current per phase	[A]	32	16 / 32	32	32
Power output					
Rated power output convected heat	[W]	3200	3200	3200	3200
Rated power output microwave (IEC 705) 100%	[W]	2000	2000	2000	2000
Rated power output combination mode	[W]	3200 + 2000	3200 + 2000	3200 + 2000	3200 + 2000

■ Regulatory standards compliance

Degree of protection	IPX3
Noise emission	max. 65 [dBA]
Approval marks	
Tested safety	UKCA, CE, CB (IEC), UL
Hygiene	UL-EPH (NSF/ANSI 4)

■ Technical data, checks and verification

Description	Features	Function	Rating	Trouble shooting
Fuses	Ceramic Time Delay	Supplies voltage from the VFD to the convection fan motor	3 x 6.3 Amp	<p>Check continuity through fuse. Check fuse holder for cracks. Check for line potential on both terminals of fuse holder.</p> <p>Door Open message displayed when F5 or F6 has failed open circuit. No functionality when F1 or F2 has failed open circuit</p>
Fuse F1 & F2	Ceramic BS1362	Control Circuit supplies voltage to the LV transformer and auxiliary components	2 x 13 Amp <i>*(12 Amp see note 1)</i>	
Fuse F3 & F4	Ceramic Time Delay	Heater Circuit, supplies voltage to the IO for the heating elements	2 x 25 Amp	
Fuse F5 & F6	Ceramic Time Delay	Microwave Circuit, supplies voltage to the IO Board and HV components through the interlock switches	2 x 25 Amp	
Fuse F7	Ceramic BS1362	Switched Mode Power Supply (SMPS) protection	3 Amp	
Door Interlock Switches	Common, Normally Open and Normally Closed terminals; RHS SW1 Monitor (outer, C to NC) RHS SW2 Secondary (inner, C to NO) LHS SW3 Primary (C to NO) Door Open message displayed when SW3 is open	Door switches are for safety, and they prove the oven door is physically closed or open. The microwave circuit will not be energized if the door is open. Live runs through these switches. Sequence: When opening the door: SW3 opens first, then SW2 opens, lastly SW1 closes. When closing the door: SW1 opens first, then SW2 closes, lastly SW3 closes	SW1 & SW2: 250VAC 22A SW3: 250VAC 20A (up to 75A inrush)	<p>Check operation in Diagnostic View Check F5 & F6 Check for continuity Check for proper wiring Check for proper adjustments Check for physical damage such as bent activating tabs (see section 6.5 'Adjusting the door microswitches') Check IO Board connections X400, X401, X402 and X412 Check IO LED 6. Check for line potential on SW3 NO</p>
EMI Filters (Mains Filters)	Filters unwanted frequency noise from interfering with various circuits and components in the oven	For use on the main supply feeding all branch circuits.	115/250VAC 50/60Hz 20A @ 40°C Line (L&N) or Load (L'&N') = 330kΩ L1 (L&L') or L2 (N&N') = 0Ω Ground (G&L), (G&N), (G&L'), (G&N') = open	<p>Check for signs of overheating or dis-colouration. Check for shorts to ground from all Live and Neutral terminals. Check for steady voltage (Live & Neutral) to the filter. Check for steady voltage (Live & Neutral) out of the filter</p>
Enclosed Switch Mode Power Supply Module (SMPS)	M3.5 screw connections. Pre-set output voltage adjustment. LED self-test indicator	Provides a stepped down rectified voltage of 12VDC to the IO (Relay Board) for controller operation.	Input Voltage 100 - 240VAC 50/60Hz 2.1A Output Voltage 12VDC / 8.5A @ 50°C.	<p>Check LED 1 Check IO +12V LED Check PSM connections Check IO Board connections X100, X101 and X500 Check input voltage Check output voltage.</p>

Description	Features	Function	Rating	Trouble shooting
Cooling Fan	Supplies fresh air into the component chamber to cool down the electrical components. The fan should run counter clockwise (looking down from above). The fan will continue to run until the oven is switched off after cleaning cycle. Motor has internal Thermal Overload Protection on the Live	Supplies fresh air into the component chamber to keep the electrical components cool. Fan should run counter clockwise. Draws air in through the filter under the door and out the rear of the oven	230VAC, 0.23A 52W @ 50Hz / 0.3A 70W @ 60Hz Resistance: 198 - 222Ω (222Ω across connection terminals). Capacitor 1.5μF	Check operation in Diagnostic View Check for opens, shorts or grounds Check for locked rotor (Power Off) Check IO connection X110 Check IO LED28 Check for Live supply potential on fan connection Check Event Log for IO & UI temperatures and E103 events
Cooling Fan Capacitor	Connects to the cooling fan at the connection plug	Stores and discharges voltage to start and run the cooling fan motor	400V, -25/70°C, 1.5μF ±5%	Check for proper microfarads. Check for opens, shorts, or grounds. Warning: Capacitor may have a stored charge, discharge before testing
Stirrer Motor(s)	Mounts directly on the wave guide above the cavity, supply voltage connected directly from the IO Board. Driving the stirrer antennae in the horn area of the microwave launch on the cavity, through the gear assembly	Drives a stirrer antenna to evenly distribute or scatter microwaves into the oven cavity	230VAC 2.7W. Resistance 7 – 8kΩ	Check for opens, shorts or grounds Check for locked rotor (Power Off) Check IO Board spade connections X112 Check IO LED27 Check for Live supply potential at IO X112 pins 1-2 & 3-4
VFD (Motor Speed Controller)	Takes 1PH AC supply voltage and produces a 3PH DC square wave frequency output. 3ph fan supply protected individually by 3x 5A ceramic on board fuses.	Provides an DC, 3-phase switched mode drive to the AC convection motor and is controlled by a 0-10 VDC signal from the relay board (IO). The frequency output allows the Main Blower Motor to run at variable speeds	1ph power supply. Control Signal Voltage 10VDC output to the IO Board, 2-10VDC return to determine speed percentage of convection fan motor (2-7.5VDC on 16A/13A ovens). Output 3ph DC square wave frequency voltage	Check electrical connection Check IO Board connections X113 & X519 Check IO LED29 Check VFD LED sequence. Check for 10VDC at pins P2 (Green) & P3 (Blue). Check for 1-10VDC at pins P1 (Red) & P3 (Blue) Check Live supply potential on VFD Check for consistent output voltage between each phase between Blue (U), Red (V) & Yellow (W) (Digital multi-meter should be set to VAC to conduct this check)

Description	Features	Function	Rating	Trouble shooting
Convection Motor	The convection motor is a 3-phase AC motor that runs at variable speeds and is powered by a motor speed controller (VFD Drive). The windings are thermally protected (two grey wires). The fan will continue to run until the oven is switched off (Idle fan speed reduces to 30% once cooled down to 100°C & below).	Provides variable percentages of airflow that is heated into the oven cavity used for accelerated cooking. This is the convection and impingement process.	Supply Voltage: DC square wave frequency that simulates 3ph voltages up to 220V at 100% Resistance: $7.5\Omega \pm 10\%$ across windings	Check for opens, shorts or grounds Check for locked rotor (Power Off) Follow VFD Drive Trouble shooting checks.
Convection Motor IP	Thermal Switch within the Convection Motor. Two black wires. Normally Closed, monitors convection fan motor internal temperature. Opens when the motor gets too hot	Breaks connection between wires 82 & 83 for the relay coil on the on the VFD Drive Live supply, which in turn stops the voltage supply to the convection fan motor.	Switched Voltage; 12VDC Resistance if open O.L., if closed = 0Ω Opens at 160°C (320°F)	Check continuity through switch. Check convection fan motor IP connections on Safety Relay. Follow Convection Motor Trouble shooting checks
Convection Fan Safety Relay	Controlled by the thermal switch (IP) within the convection fan motor.	Switches the power supply, wires 80 (64) to 84, on to the VFD (Motor Speed Controller) when the convection fan motor temperature is within normal operating limits (IP closed circuit).	Coil Voltage; 12VDC, Resistance 295 Ω . Switched Voltage 230VAC, Resistance if open O.L., if closed = 0Ω	Check SMPS connections 81 & 82. Check convection fan motor IP continuity and connections.
Overheat Thermostat (Over Temp Stat / Cavity Stat)	Manual reset, capillary tube, normally closed, monitors cavity temperature. Opens when the cavity temperature gets too hot	Breaks control safety circuit control voltage signalling the IO Board to de-energise heating and microwave circuits based on the temperature inside oven cavity. The oven shuts down and displays E104.	Switched Voltage; 12VDC. Resistance if open O.L., if closed = 0Ω . Opens at 300°C (570°F)	Check continuity through switch. Check for 12VDC on both sides of switch. Terminals are normally closed, if open, reset thermostat and test oven for proper operation Check IO X512 Check IO LEDs LD14 to LD18

Description	Features	Function	Rating	Trouble shooting
Magnetron Limit Stat(s)	Automatic reset. Monitors surface temperature. Normally Closed, opens when the magnetron surface temperate gets too hot	Breaks control safety circuit control voltage signalling the IO Board to de-energise heating and microwave circuits based on the temperature of the magnetron case. The oven shuts down and displays E117, E118.	Switched Voltage; 12VDC. Resistance if open O.L., if closed = 0Ω. Opens at 125°C (257°F), automatically closes once magnetron case temperature drops to 80°C (177°F)	Check continuity through switch(es). Check for 12VDC on both sides of switch(es). Allow magnetron to cool before testing. A dirty air filter is a major root cause of this failure Check IO connections & plugs on X513 & X514 Check IO LEDs LD16 & LD18
Heating Element(s)	X12 – Single sheath resistive heating element sealed terminal ends. X16 - Two sheath resistive heating elements sealed terminal ends. Wired in parallel. Heating element(s) remain on for 30 secs after opening the door.	Provides heat for the oven cavity. When air passes over the surface, heat is transferred into the air.	Supply Voltage 230VAC pulsed from the IO Board to control power (wattage). X12 – Resistance: 19Ω between terminals, (any terminal to ground: open). Maximum power 2200W X16 - Resistance: 26Ω between terminals, (any terminal to ground: open). Maximum power 3200W	Check F3 & F4 Check Neutral connections, EMI Filter. Check resistance ratings. Check IO terminal connections X200 & X210. Check for opens, shorts & grounds. Check IO LEDs LD1 & LD25 Check Live supply potential at heater terminals Check Error Log for E102 & E116 events
Magnetron(s)	One Magnetron fitted as standard, two Magnetrons fitted to High Power oven versions	Provides microwave energy, 0 to 100%, through the waveguide(s) into the oven cavity for accelerated cooking. At 50% power the microwave circuit cycles 20 seconds on / 20 seconds off	X12 - 1000W per magnetron, 7-8A at 230VAC. X16 – 900W per magnetron, 6.5A – 7.5A at 230VAC. See HV Components in Section 5.8 for further rating information. (NOT TO BE TESTED LIVE)	Follow all test procedures in Section 5.8. Check for opens, shorts & grounds. Check IO Board connections X400, X401, X403, X410, X411 & X412. Check IO LEDs LD4, LD5 & LD21 Check Error Log for E101 & E113 events

Description	Features	Function	Rating	Trouble shooting
HV Transformer(s)	One HV Transformer fitted as standard, two HV Transformers fitted to High Power oven versions, wired out of phase with each other.	Provides both the stepped down and stepped up Voltages for the for the Magnetron(s)	Primary winding: 200 / 230 VAC. Secondary winding to Magnetron Filament = ELV, and approximately 1:10 stepped up High Voltage for microwave circuit (NOT TO BE TESTED LIVE). See HV Components in Section 5.8 for further rating information. <i>*(208 / 240 VAC see note2)</i>	Follow all test procedures in Section 5.8. Check for opens, shorts & grounds Check IO Board connections X403, X410, X411 & X412. Check IO LED 3 & 4 Check Error Log for E101 & E113 events
HV Capacitor(s)	One HV Capacitor fitted as standard, two HV Capacitors fitted to High Power oven versions. Internal discharge resistor.	In conjunction with the HV Diode(s) to double the stepped up voltage from the HV Transformer(s)	2,500 VAC, 1.20 μ F \pm 3%. See HV Components in Section 5.8 for further rating information (NOT TO BE TESTED LIVE) <i>*(0.95μF see note 3)</i>	Follow all test procedures in Section 5.8 Check for opens, shorts & grounds Check IO Board connections X403, X410, X411 & X412. Check IO LED 3 & 4. Check Error Log for E101 & E113 events
HV Diode(s)	One HV Diode fitted as standard, two HV Diodes fitted to High Power oven versions.	In conjunction with the HV Transformer(s) to double the stepped up voltage from the HV Transformer(s), for the Magnetron DC supply	See HV Components in Section 5.8 for further rating information (NOT TO BE TESTED LIVE) 16kV, 750mA (up to 50A surge) -20°C to +135°C	Follow all test procedures in Section 5.8 Check for opens, shorts & grounds Check IO Board connections X403, X410, X411 & X412. Check IO LED 3 & 4. Check Error Log for E101 & E113 events
Thermocouple	Provides DCmV to the IO Board (Relay Board) that represents the cavity temperature	Two dis-similar metals connected at the tip that produce different repeatable millivolts while exposed to different temperatures. Green is negative, and White is positive.	See chart below for reference. E111 error when opencircuit fault exists.	Check resistance, a low resistance of 3 to 5 Ω is OK. Check for opens, shorts or grounds.

**Note 1: 12A fuse (F3) used in Americas*

**Note 2: 208/240 HV Transformers used in most 60Hz applications*

**Note 3: 0.95 μ F Capacitors used in most 60Hz applications.*

Always review country specific service parts lists for required replacements. Never use non-approved alternatives. See section 6.18 for the Technical Data Summary Sheet.

3.2 Dimensional drawings

conneX 12

Front view (door closed)

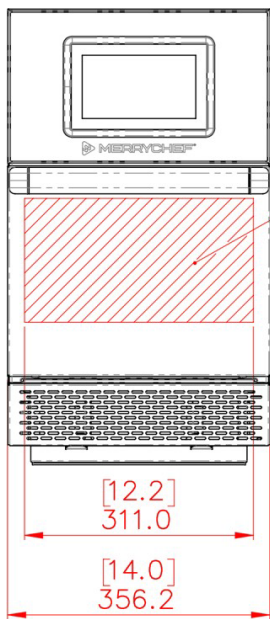

Cavity dimensions (door closed)

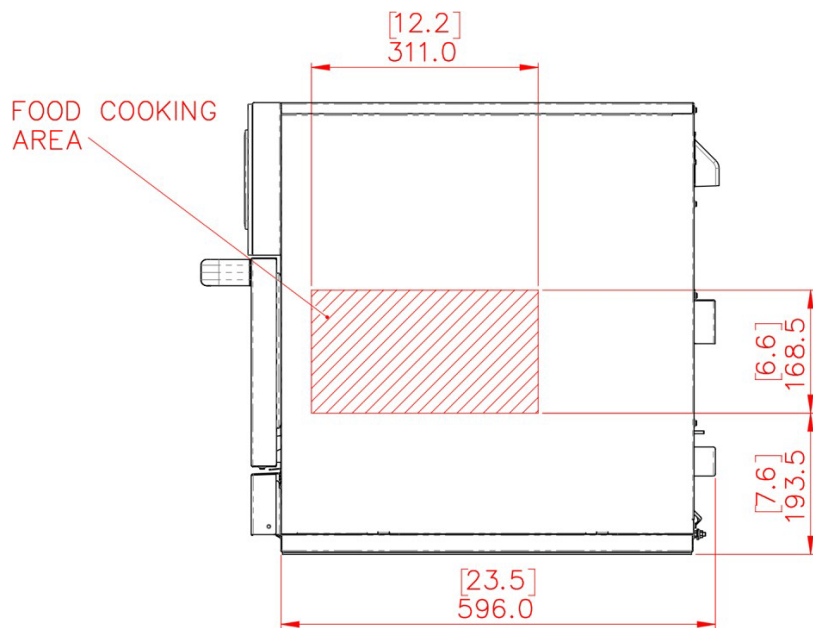

View from the top (door closed)

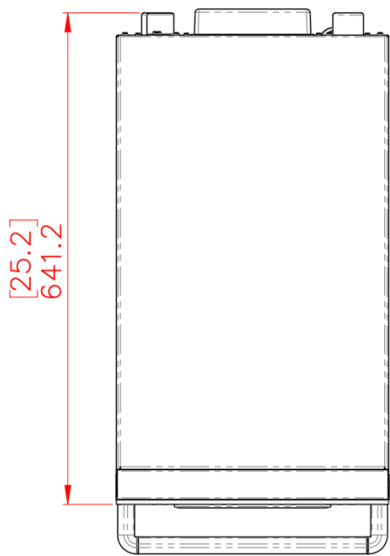

View from the right-hand side (door open)

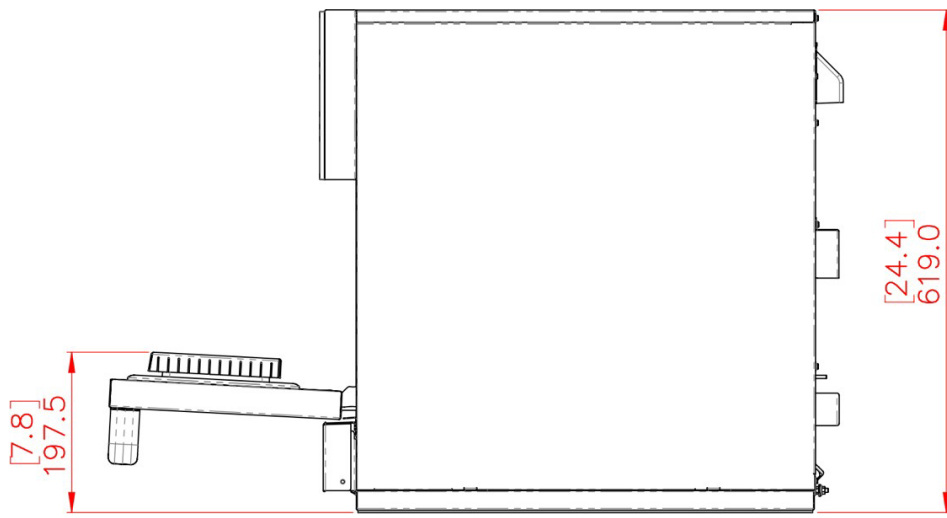

■ **conneX 16**

Front view (door closed)

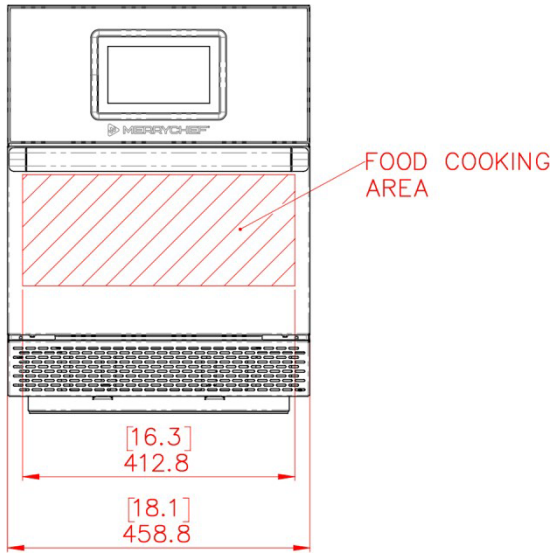

Cavity dimensions (door closed)

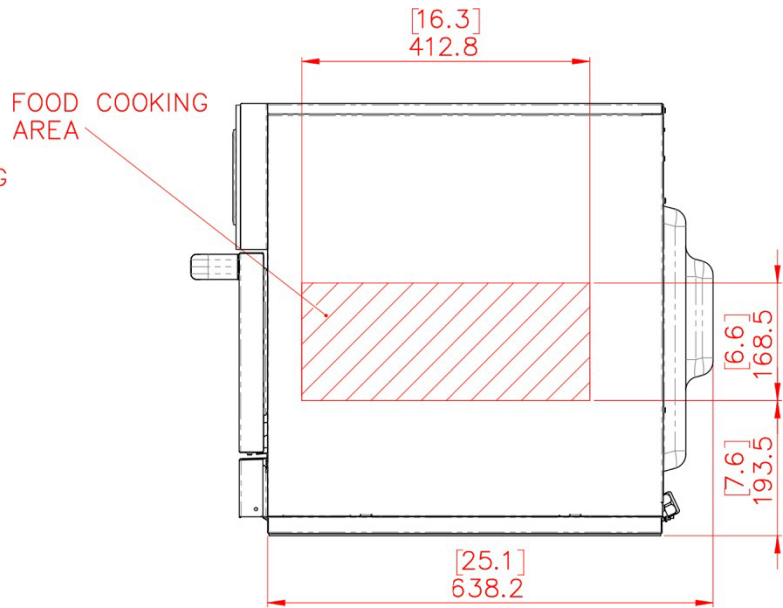

View from the top (door closed)

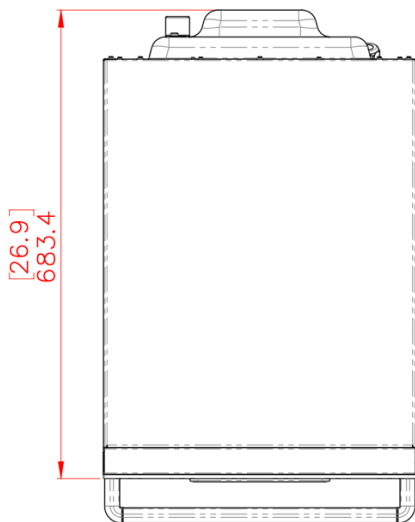

View from the right-hand side (door open)

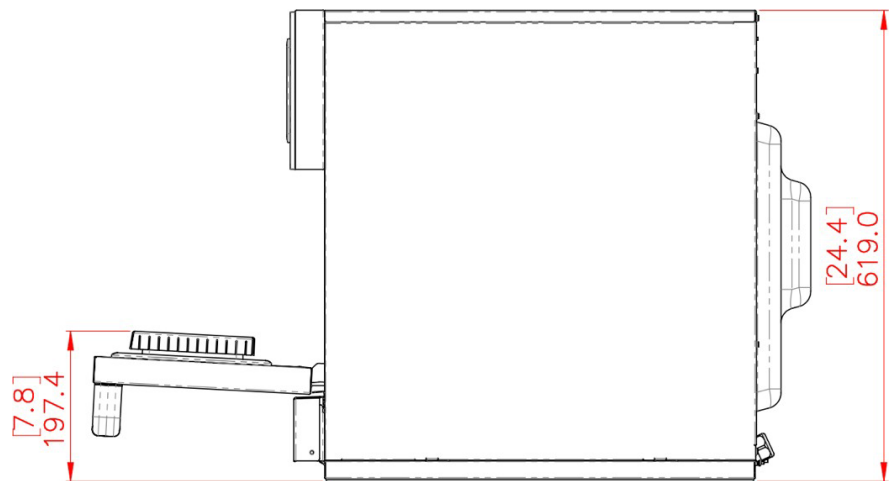

4 Accessing the easyTouch® 2.0 screen

Purpose

Instruct the user regarding all safety-related functions and devices.
Instruct the user in how to operate the appliance.

4.1 Main menu screen

Appearance

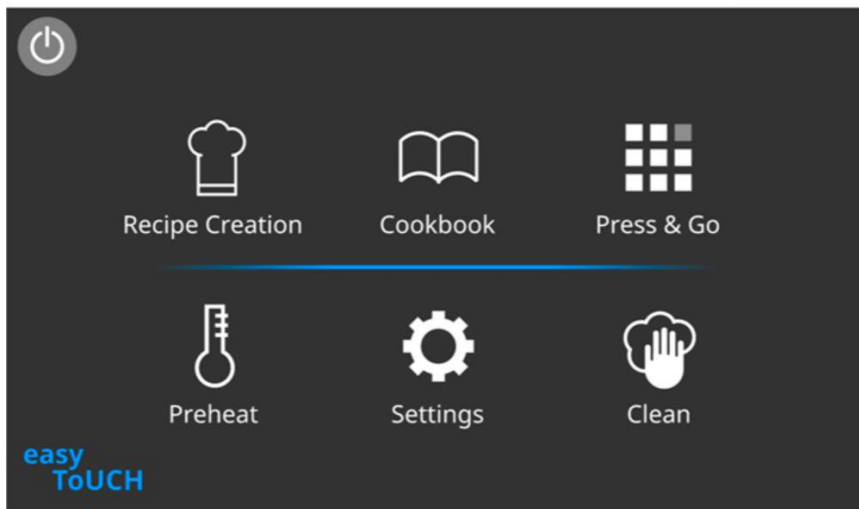

The buttons and what they do

Button	Meaning	Function
	Recipe creation Development Mode	'Recipe creation' enables multistage cooking profiles to be developed, then stored under a name and icon for reuse.
	Cookbook	'Cookbook' contains the cooking profiles stored in the memory of the appliance. It displays favourites, cooking profile groups and a complete listing of all cooking profiles available.
	Press&Go	'Press&Go' allows quick access to use the cooking profiles that are already stored.
	Preheat	'Preheat' is used to control the appliance operating temperature, upto six preheats can be stored on the appliance.
	Settings	'Settings' is used to control the appliance settings and functions including time and language, loading cooking profiles and for service and maintenance purposes.
	Cleaning	'Cleaning' allows the appliance to be prepared for cleaning with fully guided and customisable assistance during the cleaning process.

The easyTouch® 2.0 screen display

The easyTouch® 2.0 screen display, layout and icons shown herein are for guidance purposes only and are not intended to be an exact representation of those supplied with the appliance.





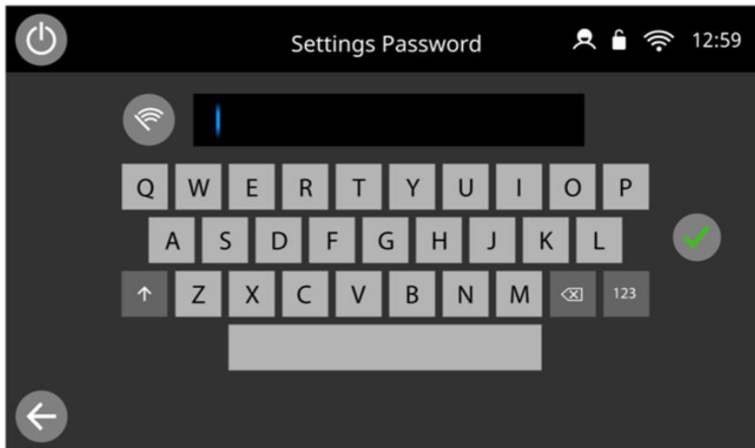

Full operational details can be found in the Installation and User Manual.

4.2 The keyboard screen

Appearance



The buttons and what they do

Button	Meaning	Function
	Keyboard screen	The keyboard screen is used to enter an authorised password to enter data for programmes and may restrict operator access to some functions.
	Clear screen	Select the 'clear screen' key to delete text from the keyboard screen.
	Keyboard	Type in text using the keyboard.
	Keyboard scroll	Select the 'numbers' key to switch numbers & special characters keyboard. Press the 'letters' key to return to the letters keyboard.
	Keyboard scroll	Select the up arrow to scroll the keyboard screen for lowercase.
	Enter / OK	Select the green check mark to confirm settings and continue.
	Previous screen	Select the 'backspace' key to return to a previous screen.

Character length

For names of cooking profiles, names of cooking profile groups and passwords use 1-20 characters in 2 lines max. For stage instructions of individual cooking profiles use 1-52 characters in 5 lines max.

Full operational details can be found in the Installation and User Manual.

4.3 Cleaning procedures

IMPORTANT
Cool down the oven before



You will need

PPE:

- heat proof gloves
- protective rubber gloves
- eye protection

Cleaning materials:

- non-abrasive nylon scrub pad
- cleaning cloths
- Merrychef oven cleaner (or Merrychef approved cleaning chemicals)
- Merrychef oven protector

Cool down the oven

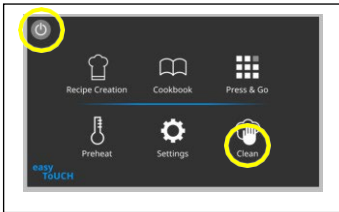

1. Press the clean icon from the main menu (full serve mode) or the on/off button on any screen.

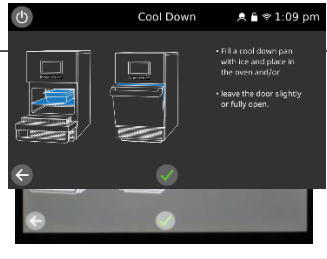

2. Place a pan of ice into the oven to speed up the cool down process (if instructed) or leave the door slightly open. Press the green tick to continue at each stage.

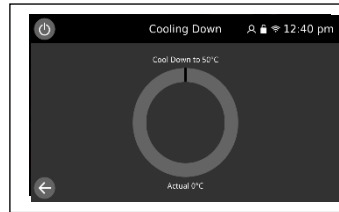

3. Wait for temperature to reduce to 50°C or 122°F. This can take up to approximately 20 mins.

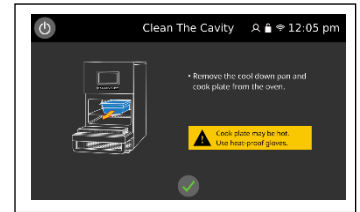

4. Once the cooling process is complete, remove the cook plate and pan of water if used. Then follow the screen instructions - the oven is now ready for cleaning.

Do not leave the pan of water in the oven overnight.

Pan and water may be hot. Use heat proof gloves.

Clean the cold oven

Wear PPE

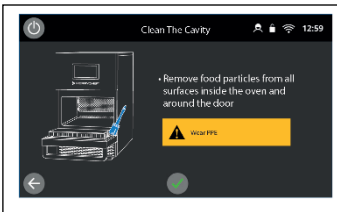

5. Use a dry clean brush to remove any food particles from between the cavity floor and the inside of the front door.

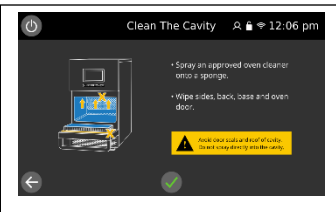

6. Spray Merrychef approved cleaner onto a sponge and wipe onto the sides of the inside of the oven, the back, the base and the oven door. Avoid the roof and door seal.

Do not spray directly into the cavity. Avoid the roof and door seal.

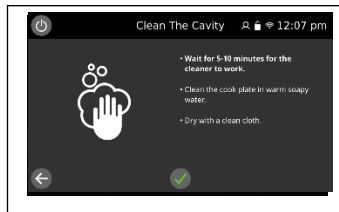

8. Clean the cavity with a non-abrasive sponge. Wipe off the cleaner with a wet cloth, ensuring all cleaning chemicals and debris are removed. The cavity roof and door seal can also be gently wiped if necessary, to remove food debris. Dry with a clean dry cloth.

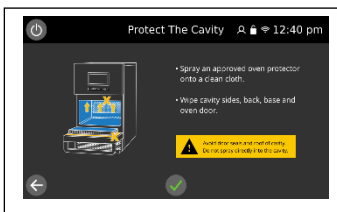
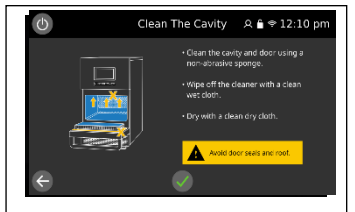

9. If instructed spray Merrychef approved protector onto a clean cloth and wipe cavity side, back and oven door. Refit the cook plate.

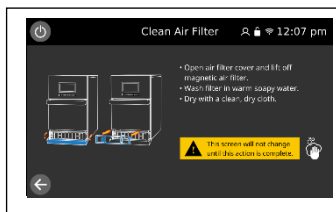

10. Remove the air filter and wipe it clean or wash in soapy water. Dry and replace.

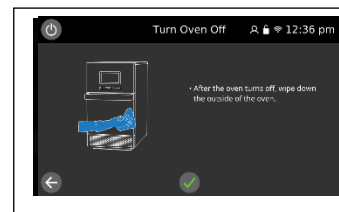

11. After the oven switches off. Wipe the outside of the oven with a clean sanitised cloth.

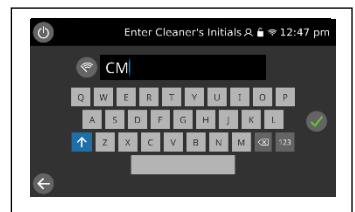

12. If instructed enter the cleaners' initials. The oven will switch off on completion.

WARNING: Do not use the oven without a clean filter in place. Do not use caustic cleaners in the oven cavity as they cause permanent damage to the catalytic converters. Do not use tools, sharp implements, or harsh abrasives on any part of the oven.

4.4 Using a USB stick

Port location

The USB port is located below the door next the inner air filter.

The USB cover protects the USB port so that no water vapour can get into the control electronics during cooking or cleaning. During cooking and cleaning, there must not be a USB stick inserted and the USB port must be closed by the cover.

USB programs (menus)

IMPORTANT:

Downloading from a USB memory stick will clear all the existing programs in the memory of the appliance.

Check that the key has the correct number/code for the programs you want to load into the memory and the correct file structure.

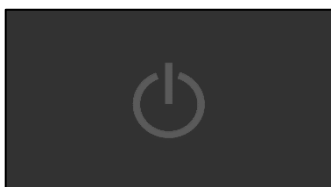
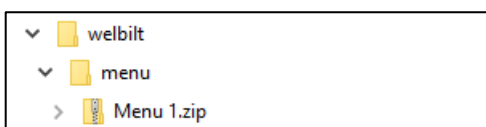

1. With the appliance switched OFF.



2. Open the filter cover access the USB port and lift the cover up.

3. Plug in the USB memory stick.

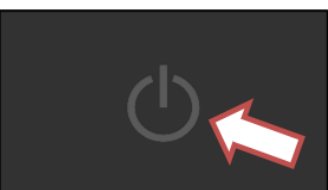

4. Switch the appliance ON.

5. After the Welbilt start-up screens, the oven will display the menu, or choices of menus that can be selected of the USB.



6. Select menu file and then the green tick.

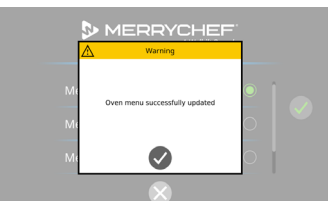

7. Select the tick on completion to end.

8. Unplug the USB memory stick.

5A. After the Welbilt start-up screens, the oven will display the menu, or choices of menus that can be selected of the USB.



Menus can also be downloaded onto the oven through settings / updates, without the need to turn off the oven first.



Load only the correct complete menu file onto the USB memory stick and not a single cook menu.

4.5 Firmware updates

Overview

Firmware updates

There are two firmware files required for the conneX oven: the main operating firmware and IO firmware. All firmware files are pre-installed but may require updating as per instruction from the manufacturer or as part of hardware replacement. Firmware files are updated by loading the required files to a USB memory stick, in the correct file structure, and then downloading this information to the appliance using the USB memory stick slot on the oven.

Procedures to load USB sticks and download to appliance

Important notes:

- Downloading from a USB memory stick will clear all existing programs.
- Only use an empty USB memory stick formatted to FAT32.
- The firmware files must be copied keeping to the correct file structure on the USB memory stick.
- Ensure USB memory stick is 'ejected' from computer after loading files, not just unplugged as files may be corrupted.
- Do not attempt to read firmware files on a computer as files may be corrupted.
- Do not remove the USB memory stick during the download sequence as this could corrupt the data transferred from the USB stick.
- It is recommended to save the existing oven menu files before uploading new firmware.
- If you have a menu file on your USB memory stick, then the menu of the appliance will be overwritten.
- If you do not have a menu file on your USB memory stick the menu of the appliance stays as it is.

USB file structure

Main firmware only	Itemised firmware	Main firmware & menu files
<ul style="list-style-type: none"> ▼ welbilt <ul style="list-style-type: none"> ▼ firmware <ul style="list-style-type: none"> xxxxxxxxxxxxxxxxxxxxx.tar 	<ul style="list-style-type: none"> ▼ welbilt <ul style="list-style-type: none"> ▼ iofirmware <ul style="list-style-type: none"> xxxxxxxxxxxxxxxxxxxxx.bin 	<ul style="list-style-type: none"> ▼ welbilt <ul style="list-style-type: none"> ▼ firmware <ul style="list-style-type: none"> xxxxxxxxxxxxxxxxxxxxx.tar ▼ menu <ul style="list-style-type: none"> xxxxxxxxxxxxxxxxxxxxx.zip

There are two methods for installing firmware files: manual or automatic. The recommended automatic method is the simplest method as it does not require the operator entering the oven settings.

Note: Folder titles are case sensitive.

In the firmware folder is where the User Interface firmware file will be placed, this will be a .tar file.

In the iofirmware folder is where the oven control board firmware will be placed, this will be a .bin file.

In the menu folder is where saved menu files transferred from the oven will be placed or if you have created a menu file from the online portal the saved .zip file should be placed in this folder.



Within the resources folder is where images and sounds are stored, which can be accessed and downloaded to the media library of the oven. Ensure that under the resources folder you have an image and sounds folder to store images and sounds, that you would like to upload to the oven.

Images formats accepted are: .JPG, .SVG, .PNG

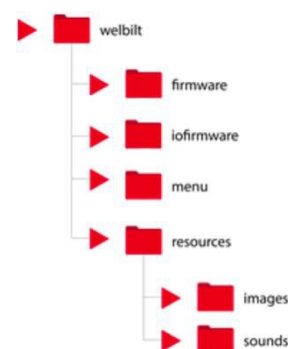
Sound formats accepted are: .WAV

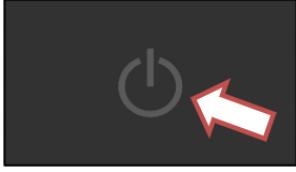
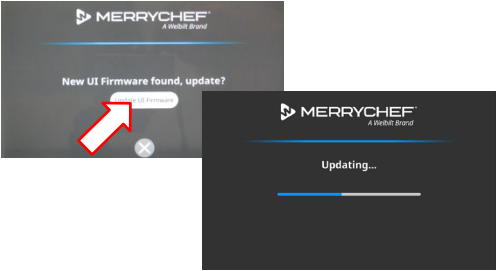

■ Automatic updates

	<p>1. Load the USB stick with the required files, keeping to the correct file structure on the ROOT directory of the USB memory stick.</p>
	<p>2. With the oven switched OFF, open the cover of the USB port and insert the USB memory stick into the slot. Wait until the USB key stops flashing (or 2 minutes) and switch oven on.</p>
	<p>3. The screen prompts "New UI Firmware found, update?" Select 'Update UI Firmware', the firmware then starts downloading. Download progress from the USB memory stick is displayed - "Updating...".</p> <p>DO NOT SWITCH THE OVEN OFF UNTIL COMPLETE</p>
	<p>4. Once loaded, the oven will reboot.</p>
	<p>5 The main firmware file contains firmware for both boards. If a newer IO Firmware version is available, a prompt will appear.</p> <p>Select the tick.</p>
	<p>The IO firmware starts downloading. Download progress from the USB memory stick is displayed - "Updating...".</p> <p>DO NOT SWITCH THE OVEN OFF UNTIL COMPLETE</p>

Once completed you will be prompted to confirm / alter the language, time & date and Wifi settings.

■ UI micro SD card & IO PM replacement - firmware update

The user interface (UI) contains the main operating firmware, serial number of your appliance, temperature calibration, event log, communication profiles, cooking profiles, application icons and the recipe images.

The personality module on the IO board contains the IO firmware.

UI Firmware may have to be updated on replacement of the SD card.

On replacement of the IO Personality Module, if a newer IO Firmware version is available, a prompt will appear. Proceed by selecting the tick (an IO firmware USB is not required).

See section 6.11 for replacing components

■ Manual updates



1. With the oven switched off, open the cover of the USB port and insert the USB memory stick into the slot. The USB memory stick should be formatted to FAT32 with the required firmware loaded.



2. Switch on the oven and wait until the Merrychef screen is displayed. Select the settings icon.



2a. The settings can also be accessed from the main screen.

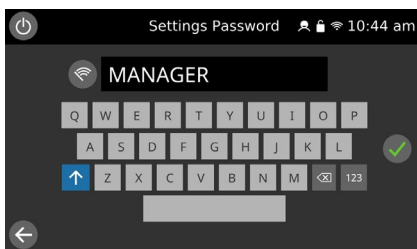

3. Enter the settings password; **MANAGER** and select the green tick.

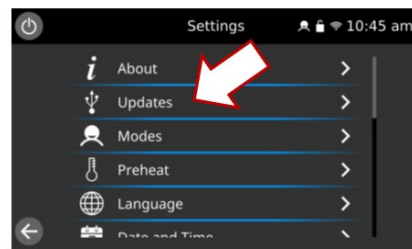

4. Select 'UPDATES'



5. Due to the size of the UI firmware, wait for 90 seconds the USB key to be read. If the "Update UI Firmware" tab remains greyed out, there is no compatible firmware available on the USB key.

■ UI firmware update



6. To update the UI firmware select the 'Update UI Firmware' tab.

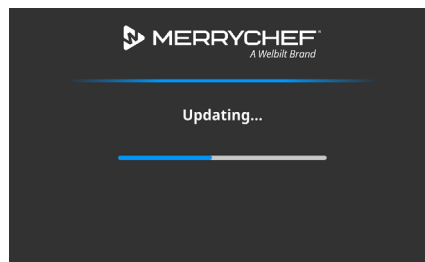

The firmware will then start updating.

Then firmware update sequence remains the same as an automatic update.

■ IO firmware update



1. To update the IO Firmware, select the 'Update IO Firmware' tab.



2. Select the appropriate IO file and then the green tick. The IO firmware will then start updating.

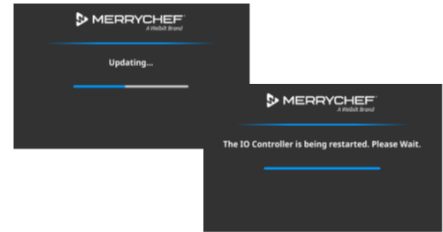

3. On completing the display will return to the Updates/Downloads screen.

■ Confirming the firmware updates

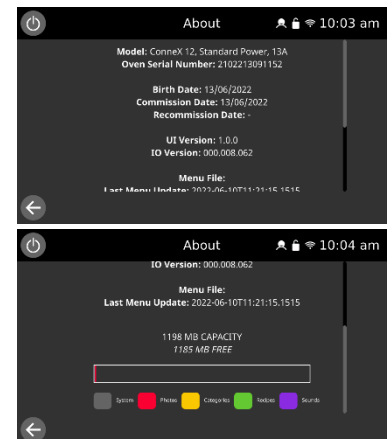

After an update of the appliance firmware check to ensure the latest firmware has been successfully loaded on to the oven. Once the oven is switched back on, it will cycle through the Welbilt brand names until reaching the Merrychef "Expanding Your Opportunities" screen. Select the information 'i' button.

Review the data displayed. Select the back arrow to return to the previous screen. The information can also be selected from the main screen/ settings.







5 Service information

5.1 Service procedure

■ Servicing procedure: overview

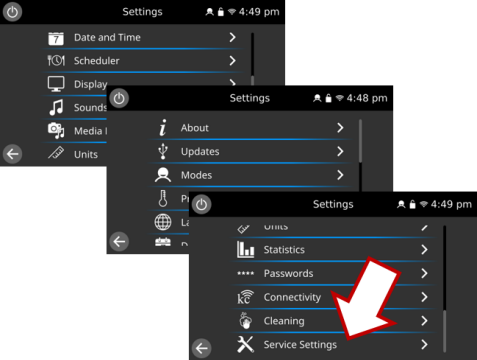
1. Disconnect/isolate the appliance from the power supply.
2. Check the appliance is correctly installed as described in the conneX Installation and User manual.
3. Visually check the cleanliness/condition of the power supply/cable, casing, cavity and door of the appliance for signs of wear, damage, distortion etc. If required, refer to the "Replacing components" section of this manual (section 6).
4. Complete an "Earth/Insulation test" (see section 5.6 of this manual) on the appliance before switching on.
5. Check the display for error messages. If an error is shown, refer to the "Fault Finding" within section 5.3 of this manual.
6. If a firmware update is required, follow the instructions under "Firmware updates" within section 4.5 of this manual before continuing with the service procedure.

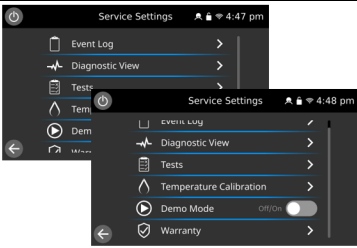
■ Enter service mode

	<p>1. Switch on the oven and wait until the Merrychef screen is displayed. Select the settings icon.</p>
	<p>2. Enter the authorised user password, for example, "MANAGER" on the keypad.</p>
	<p>3. Scroll down and select 'Service Settings'</p>
	<p>4. Enter the service password. For example; 'SERVICE' on the keypad. Select OK (green tick) to display service tabs.</p>
	<p>5. Select the relevant tab to access the;</p> <ul style="list-style-type: none"> ▪ Event log ▪ Diagnostic (visual view) screen ▪ Oven test screen ▪ Temperature calibration screen ▪ Demonstration ▪ Warranty information screen
	<p>Select the back arrow at any point to return the previous screen, or to exit the Service Settings.</p>

■ Functions of the service settings

Event Log

Check the Event Log for details of any logged appliance errors and non-error events

Diagnostic View

Check the operational performance of the main appliance components using a selectable component visual view. Check the supply voltage & frequency and ambient temperatures.

Tests

Check to perform the tests of your microwave combination oven as described in the “Testing selected components”, section 5.6 of this manual. If required, refer to the “Replacing components” with section 6 for any repairs needed before continuing with the tests. Follow the procedures under “Recommissioning test”, section 5.6 before commissioning your appliance for use. These tests should be completed after all repair and maintenance procedures

Temperature Calibration

To enter the oven cavity temperature calibration mode when the appliances operating temperature requires re-calibrating.

Demo Mode

Directly selectable using the slide ‘on/off’ button to place the oven in demonstration mode. In demonstration mode the appliance operates normally but does not engage the microwave or heater circuits.

Warranty

Check the warranty status of the appliance.

5.2 Errors and diagnostics

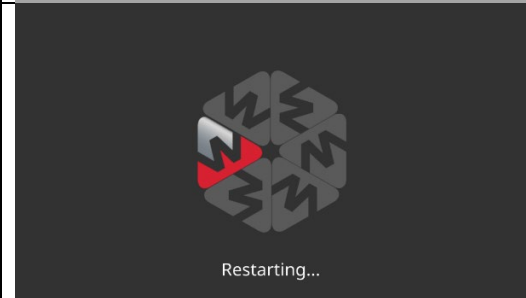
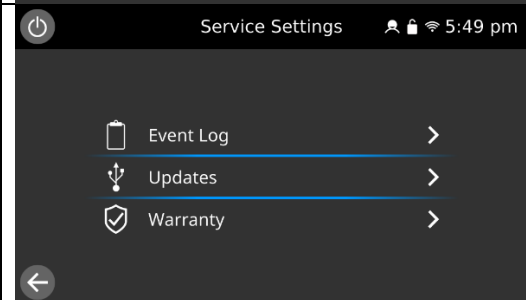

■ Error messages

	<p>A code number and description of the type of error is shown. Refer to the error codes (“Fault finding” within section 5.3 of this manual) for more details.</p> <p>The displayed QR code can be scanned with a smart phone to access the Merrychef technical support website.</p>
	<p>The ‘Restart’ button can be selected to ‘reboot’ the appliance. If the fault remains, the appliance will display the error again and prevent operation of the oven.</p>
	<p>The ‘cog’ button is selected to enter an abridged Service Settings screen, displaying three selectable tabs;</p> <ul style="list-style-type: none"> ■ Event Log ■ Updates ■ Warranty <p>See section 5.3 for error code list.</p>

■ Copying error messages

	<p>1. Enter Settings / abridged Service Settings screen and select 'Updates'</p>
	<p>2. Open the cover of the USB port and insert the USB memory stick into the slot</p>
	<p>3. Select 'Download to USB' on the Updates/Downloads screen.</p>
	<p>4. A pop up screen confirms completion of the download. Select the grey tick and remove the USB from the appliance.</p>
	<p>5. Return to the main menu using the back key on the bottom left-hand corner of the screen.</p>

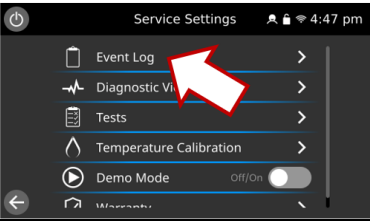
■ Event log

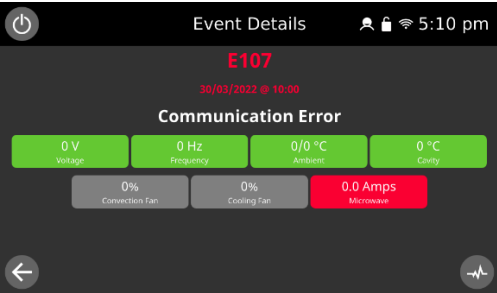
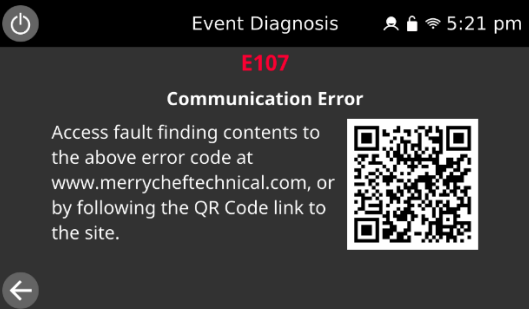
	<p>1. Enter the Service Settings and select 'Event Log' to display a listing of oven component errors & events.</p>
	<p>2. The Log can be displayed by Day, Week, Month or Year as selected.</p>
	<p>3. Selecting 'Details' shows more information pertaining to the entry.</p> <ul style="list-style-type: none"> ▪ Event code ▪ Time and date of the entry ▪ Event description ▪ Supply voltage ▪ Supply frequency ▪ UI & IO board ambient temperatures ▪ Cavity temperature ▪ Convection fan speed (%) ▪ Cooling fan speed (%) ▪ Magnetron(s) current draw
	<p>The diagnostics view screen can be accessed by selected the button in the bottom right of the screen.</p> <p>4. Selecting 'Diagnose' provides a QR code to access further assistance online.</p>

Further details can be read by copying the event log to a USB and opening the files on a computer.

Name	Date Modified	Size	Kind
▼ welbilt	Yesterday at 09:29	--	Folder
> firmware	Yesterday at 09:29	--	Folder
> iofirmware	Yesterday at 18:08	--	Folder
> menu	Yesterday at 09:29	--	Folder
▼ service	Today at 07:31	--	Folder
▼ errorlogs	Today at 08:51	--	Folder
■ 2020-11-08_to_2020-11-16_events	Today at 07:31	1 KB	Unix Ex...able File
■ 2021-02-28_to_2021-03-08_events	Today at 07:31	50 bytes	Unix Ex...able File
■ 2021-05-23_to_2021-05-31_events	Today at 07:31	702 bytes	Unix Ex...able File
■ 2021-06-06_to_2021-06-14_events	Today at 07:31	652 bytes	Unix Ex...able File
■ 2021-06-13_to_2021-06-21_events	Today at 07:31	166 bytes	Unix Ex...able File
■ 2021-06-20_to_2021-06-28_events	Today at 07:31	154 bytes	Unix Ex...able File
■ 2021-07-18_to_2021-07-26_events	Today at 07:31	699 bytes	Unix Ex...able File
■ 2021-07-25_to_2021-08-02_events	Today at 07:31	565 bytes	Unix Ex...able File
■ 2021-08-08_to_2021-08-16_events	Today at 07:31	51 bytes	Unix Ex...able File
■ 2021-08-15_to_2021-08-23_events	Today at 07:31	51 bytes	Unix Ex...able File
■ 2021-08-22_to_2021-08-30_events	Today at 07:31	166 bytes	Unix Ex...able File
■ 2021-09-05_to_2021-09-13_events	Today at 07:31	620 bytes	Unix Ex...able File
■ 2021-10-10_to_2021-10-18_events	Today at 07:31	862 bytes	Unix Ex...able File
■ 2021-10-17_to_2021-10-25_events	Today at 07:31	231 bytes	Unix Ex...able File
■ 2021-10-17_to_2021-10-25_events.csv	Today at 07:31	180 bytes	CSV Document
■ errors	Today at 07:31	2 KB	Unix Ex...able File

■ Display colour codes

Grey = Normal operation / standby

Green = On / OK

Blue = Off / OK / Selected

Yellow = Warning, out of normal range

Red = Warning, switched off

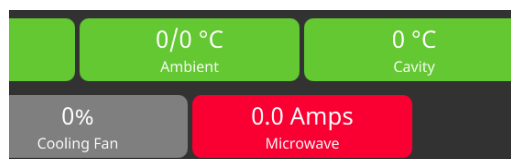

Operational statistics

Additional detail from the oven statistics may provide further information for in-depth fault diagnosis.

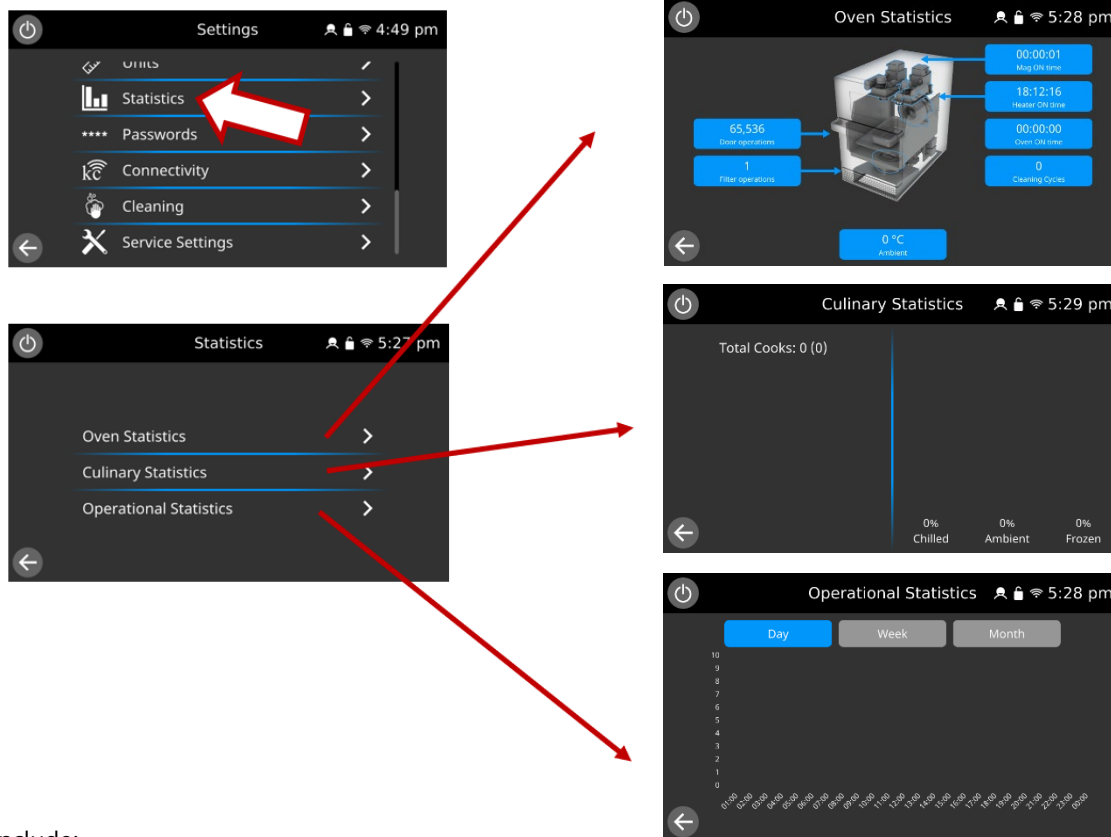

Details include;

- Left-hand magnetron operating hours (high power ovens)
- Right-hand magnetron operating hours
- Number of door openings
- Number of times the filter is removed
- Heating element(s) operating hours
- Total oven time in hours
- Number of completed cleaning cycles
- Ambient temperature around the control circuitry
- Number of individual recipe cook cycles
- Percentage of ambient, chilled & frozen food products cooked
- Time breakdown of oven operation by day, week or month.

Diagnostic view

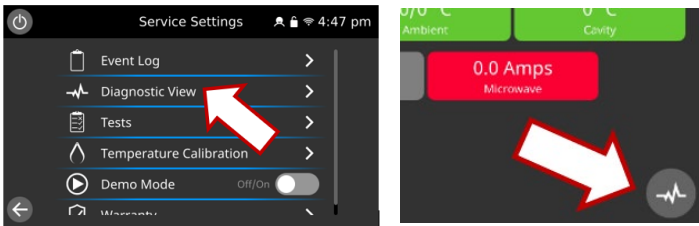
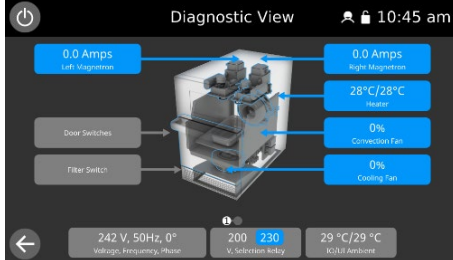
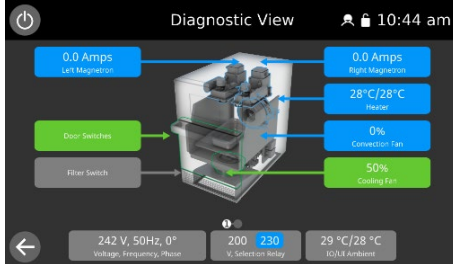
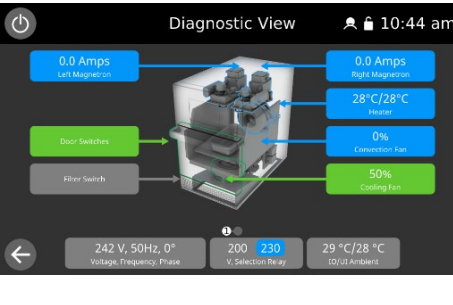
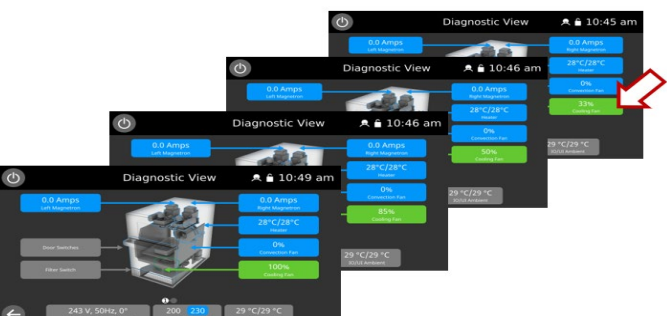
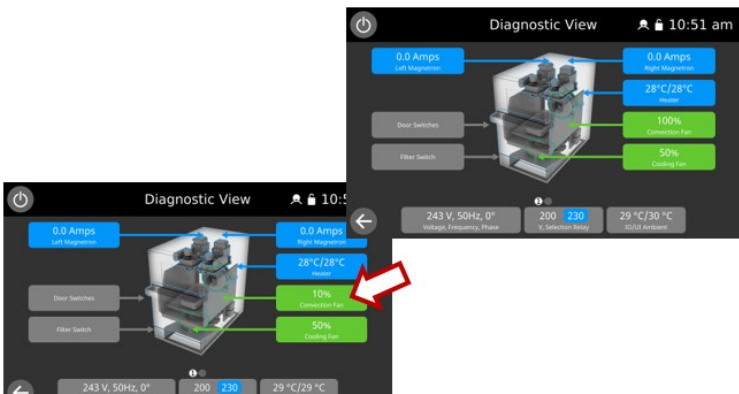
	<p>1. Select 'diagnostic view' from the service settings to check the main components of the appliance.</p> <p>Diagnostic view can also be selected from the 'Event Details' screen in the Event Log.</p>
	<p>2. Select a component symbol to switch on (red). Select again to increase the level (remains red) or turn off (blue). Except for the magnetron(s), all the component tests will work with the door open or closed.</p>
	<p>3. Remove the air filter at the front of the oven. The colour of the air filter symbol on the display should change from grey to green indicating that the microswitch circuit for their filter is operating correctly. Replace the air filter and the colour should change back to grey.</p>
	<p>4. Open the oven door. Check the colour of the door symbol changes from grey to green on the display to check that the door microswitch / interlock circuit is operating. Place door spacers onto the oven door (refer to "Adjusting the door microswitches / interlocks" in the "Replacing components" within section 6.5 for details), to confirm the door switches are adjusted correctly. Close the door and check the colour of the door symbol on the display.</p>
	<p>5. Select the cooling fan and check if it is operating correctly.</p> <p>Repeated presses will increase the fan speed, noticed by an increase in the fan noise volume and air flow through the filter (off / 33%, 50%, 85% / 100% / off).</p>
	<p>6. Select the convection fan and check if it is operating correctly.</p> <p>When increasing the fan power gradually, in 10% increments, to 100% the fan noise should become louder.</p>

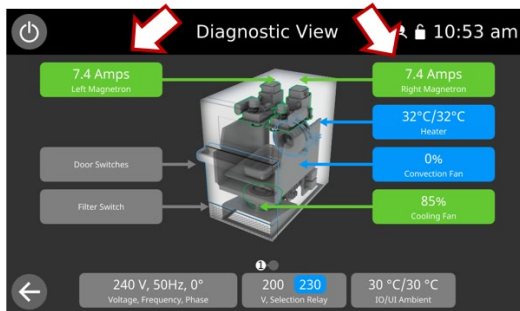
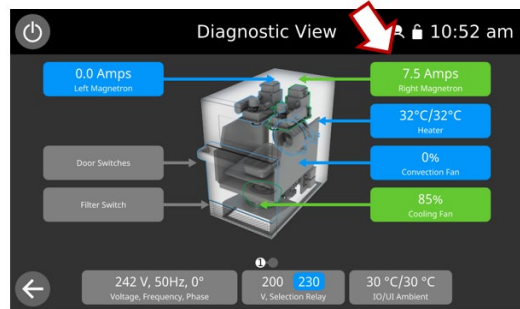
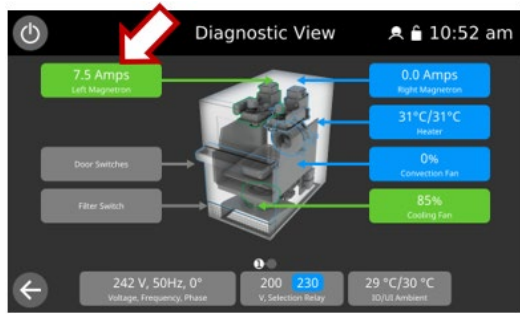

7. Place a microwave safe container of water into the cavity and close the oven door. Select a magnetron to test operation and display the current draw at maximum output. This will time-out after 30 seconds (the cooling fan will automatically run during the test).

Individual magnetron test:

If during the magnetron test the displayed current is 0 A and the E101 error occurs, then the failure can be found in the 230V circuit. Refer to the schematics to find the fault for repair (IO Board, connections, HV primary winding).

If during the magnetron test a low current draw is seen (around 3A) and the E101 error occurs, then the failure can be found in the high voltage circuit. Isolate the power supply and test the high voltage components (HV transformer, diode, capacitor, magnetron and connections) to find the fault for repair. Never measure the high voltage circuit live. See "Replacing components" within section 6 of this manual.

Dual magnetron models:

Test the magnetrons individually and together. Selecting the magnetrons again at any point will turn them off.

Using heat proof gloves, remove the container and close the oven door.

Note: The operating magnetron(s) will be displayed green.

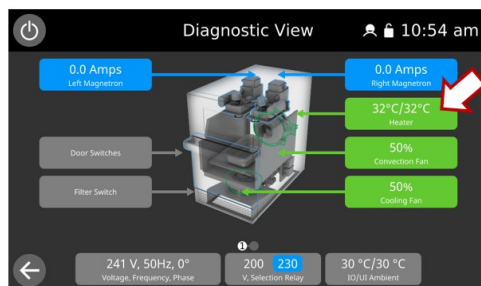

8. Select the heater. The heating element runs for 5 minutes. Selecting the heater again will turn it off. The convection fan automatically runs by default (the fan speed can be manually altered up to 100%).

Check the cavity temperatures are correct. Both displayed temperatures (thermocouple reading & calculated cavity temperature) should be similar.

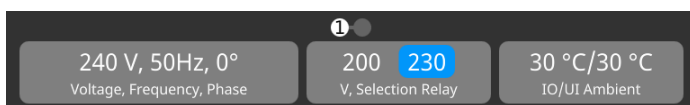

9. Further diagnostic information can be found below the oven picture:

- Mains supply Voltage & Frequency.
- The IO voltage selection for the HV transformer. The selection is highlighted in blue.
- The ambient air temperature around the IO & UI boards.

Information at the top of the screen indicates:

- Demo mode (if selected)
- Mode of operation
- Cooking programs (changes) locked or unlocked
- Wifi connectivity (displayed red when unable to connect)
- Current time

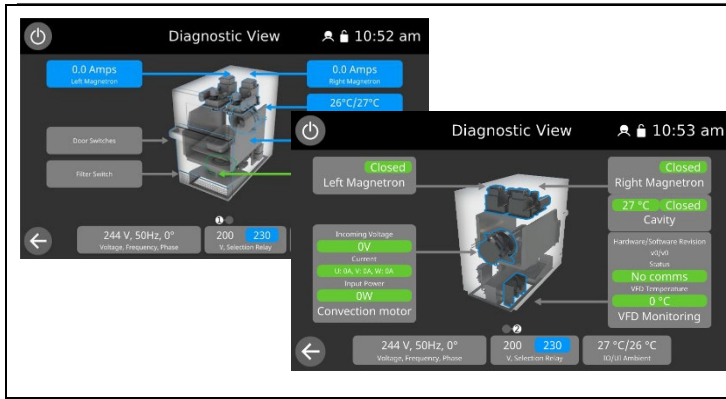

10. Swiping to the left brings up the second Diagnostic View Screen, which provides the following additional information:

- Left Magnetron Thermostat status.
- Right Magnetron Thermostat status.
- Cavity temperature and cavity Overheat Thermostat status.
- Convection Fan Motor incoming voltage, current & power.
- VFD Monitoring hardware/software revision, operating status and VFD temperature.

5.3 Fault finding

Hardware control components

Operations communication:

1. The oven has two main controlling parts, being the User Interface 'UI' assembly (keyboard, screen, logic) and the Inputs & Outputs 'IO' Board (to switch and monitor the required operation).
2. The UI is the master of the oven and instructs the IO what to do, in turn the IO communicates information on the operation back to the UI.
3. The UI and IO have their own Personality Module (PM) fitted with the respective software to be able to communicate and work with each other.
4. The power provision to the UI and the communication between UI and IO is enabled via ONE cable with a multipin (12 pin X523) connector fitted.

Start-up sequence

Once the mains power is switched ON, the UI & IO boards boot up. The screen displays 'Loading...' during this process. The screen then goes blank before the on switch appears in the centre of the screen. When the oven switch is switched ON, by tapping the centre of the screen, the display scrolls through the Welbilt brands before settling on the Merrychef Screen. The safety relays energise and then the auxiliary components start running – microwave Stirrer Motor(s), Cooling Fan & Convection Fan. From here the oven information can be viewed and the oven settings can also be accessed by pressing the appropriate button. If the oven information or settings buttons are not selected, after 5 seconds the oven then preheats or displays a preheat temperature choice when more than one is configured on the oven. Once preheated the oven displays the main menu if in "Full service mode", a recipe selection if in "Quick service mode", a recipe selection if in "Press & Go mode" or a "manual mode" dependant on the oven configuration.

Shutting down sequence

When the oven is switched OFF the oven enters the cooling mode and the microwave and heater safety relays de-energise. As part of the cleaning process, the cooling fan and convection fan operate until the cabinet temperature has been sufficiently reduced to a cavity temperature of 50°C (122°F). On completion of the cleaning process the screen will return to the on-switch display. The UI & IO boards remain active whilst a mains power supply is present.

Reboot

At any point the oven can be 'rebooted' by pressing and holding the off button in the top left-hand corner of the screen.

Exchanging data via USB interface

Loading menus/firmware from a USB memory stick and downloading the menu/recipe counters/error log to a USB memory stick is covered in sections 4.4 & 4.5 within this service & repair manual.

■ Error codes & fault-finding tips

Please adhere to all best safety practices by Merrychef and ensure the High Voltage circuitry has been successfully discharged before attempting any works on or around the Merrychef unit while the panels are off. Further information can be found at: merrycheftechnical.com

If in doubt, please contact your Merrychef/Welbilt technical support team for support.

Note: The event log can be accessed directly during an error condition, without switching the oven off and on, by selecting the settings icon.

Error	Problem	Solution
<p>E88: SUPPLY VOLTAGE ERROR</p> <p>UI displays; <i>E088 Supply voltage out of range. Please contact your Merrychef service partner to resolve.</i></p>	<p>Mains supply voltage <180VAC or >264VAC mains supply</p>	<p>Check mains supply voltage and compare with displayed voltage in diagnostic view. If similar the fault lies within the kitchen mains supply. If significantly different, check all connections from the mains supply to the IO board. If correct, replace IO board.</p>
<p>E101: Magnetron system failed at the moment microwave was needed</p> <p>UI displays; <i>E101 Microwave not responding. Please contact your Merrychef service partner to resolve.</i></p>	<p>The oven asked for microwave power, but the dynamic measurement of microwave percentage power is too low.</p> <p>(the ampere values during microwave operation help determine where the fault is located)</p>	<p>Use Diagnostic View in the service mode for analysing/testing the individual magnetrons. One magnetron at a time.</p> <p>Zero amps (0A) indicates a fault in the primary circuit (wiring from the IO board to the and including the HV Transformer).</p> <p>A current draw lower than 5A indicates a fault in the secondary circuit (wiring and components after and including the HV transformer). Isolate the power supply and test the high voltage components (HV transformer(s), diode(s), capacitor(s), magnetron(s) and connections) to find the fault for repair.</p> <p style="text-align: center;">DO NOT SUSPECT IT'S THE MAGNETRON AT FAULT FIRST</p> <p>Go to the event logs, is the mains voltage normal at time of fault? (note that the current draw detailed in the event log is the sum of all magnetrons fitted, test one at a time)</p> <p>Voltage too low, <10% of nominal voltage; There may not be enough voltage to start the magnetron.</p> <p>If the above did not resolve the issue, check all the LV connections are tightly fitted, from the incoming power supply through the Filter, Fuses F5 & F6, Door Switches, IO board and from the IO board to the HV transformer(s). The connections on the HV side from the HV Transformer through the Capacitor(s), HV Diode(s) and Magnetron(s). Also check the HV Transformer(s) is firmly bolted down (the body of the transformer forms part of the HV circuit).</p> <p>There are many connections so each of them is important to be tightly connected and checked. Most important connection: "the loose one" (ensure all connections are solid and in good working condition).</p>
<p>E102: HEATER FAILED</p> <p>UI displays; <i>E102 heater on without request. Please contact your Merrychef service partner to resolve.</i></p>	<p>The cavity reaches 75°C above setpoint for >30 minutes or above 300°C</p>	<p>The heating element is activated even though the controller hasn't asked for heating. This typically happens when the output Triac has short circuited.</p> <p>Check temperature probe is reading a reasonable temperature.</p> <p>Check temperature probe connections IO X530</p> <p>Change the UI board and check carefully all related circuitry including loose wiring and connections.</p> <p>Ensure the oven cabinet is clean and there are no leaks from the cavity.</p>

<p>E103: Ambient Overheat</p> <p>3 different error states, see solution 'UI displays:'</p>	<p>The ambient temperature around the UI & IO boards are >65°C, insufficient cooling of the components. Frequently observed when the customer forgets to clean the front filter.</p>	<p>The Air Filter must be cleaned on a daily basis.</p> <p>Check that the oven is not installed near to a heat source enabling the cooling fan to draw in hot or grease laden air via the Front Filter.</p> <p>Check that the Cooling Fan is operating correctly:</p> <p>Inspect and ensure that the cooling fan is running freely and that the speed is correct. If the speed is very slow and running freely replace the cooling fan capacitor. The wiring of the capacitor is sensitive, ensure you connect the wiring like for like, otherwise the fan may rotate in the opposite direction. The fan should run counter clockwise (looking down from above) drawing air from the centre of the fan into the component interior of the oven, creating a positive cabinet air pressure. That's why the panels should all be nicely fitting as it is part of the design to ensure proper air flow and cooling.</p> <p>The error will remain until the board temperatures drop below 65°C.</p> <p>Check the board temperatures in the event log and in visual view (in service mode). UI temperatures significantly higher than the IO can indicate a poor door seal.</p> <p>UI displays:</p> <ul style="list-style-type: none"> • Message 1 if Ambient >70°C, Pre air filter removal. <i>"Ambient overheat detected, please remove, replace and clean the air filter located below the door"</i> • Message 2 if Ambient >70°C for <2mins air filter removed and replaced, <i>"Oven cooling please wait"</i> if Ambient <70°C for <2mins air filter removed and replaced, Oven power cycles, returns to normal operation • Message 3 if Ambient >70°C >2Mins, air filter removed and replaced <i>"E103 ambient overheat."</i> <i>Please contact your Merrychef service partner to resolve"</i> Restart button displayed
<p>E104: cavity overheat stats released</p> <p>UI displays; <i>E104 Cavity Overheat stat triggered. Please contact your Merrychef service partner to resolve.</i></p>	<p>The safety thermostat circuit (12vdc) is open circuit - IO connections X512.</p>	<p>Manually reset the cavity overheat thermostat at the rear of the oven.</p> <p>Check the connections on the cavity overheat thermostat and IO board X512.</p> <p>Check the continuity of cavity overheat thermostat.</p> <p>Check Cavity overheat thermostat LED14 on the IO board.</p> <p>Check temperature probe is readings a reasonable temperature.</p> <p>The cavity overheat thermostat typically trips if the mains power is disconnected at the end of service without allowing the cavity to sufficiently cool down first. Noticed by the E104 error occurring at the beginning of service the next day.</p>
<p>E105: Mains Supply Frequency Issue</p> <p>UI displays; <i>E105 Mains Supply Frequency Issue. Please contact your Merrychef service provider to resolve.</i></p>	<p>Mains supply frequency is ±2Hz from nominal</p>	<p>Mains supply frequency is ±2Hz from nominal or interference e.g., an internal microwave leak? Most of the issues found here are related to an unstable power supply of the building, i.e., Generators. It is recommended to check the supply and/or analyse the error log on a computer</p> <p>Ensure there are no microwave leaks by inspecting the unit with a suitable microwave leak detector</p> <p>Ensure there is a bowl (suitable for microwaves) of water (250ml cold) and activate a microwave leak test in the service screen mode. Check around the door seals front and rear of the unit. If microwave leaks are observed (if a level of 5mW/cm² or higher is observed the oven must not be used until repaired) unplug from the mains and investigate. Note: there should be no microwave leakage and corrections should be made if any leakage is detected above 0.5mW/cm².</p> <p>Check for damaged cavity thermocouple</p>

<p>E106: Cavity overheat</p> <p>UI displays; <i>E106 cavity overheat detected. Please contact your Merrychef service partner to resolve.</i></p>	<p>The cavity reaches 75°C above setpoint or above 300°C during a cook cycle.</p>	<p>See E102.</p> <p>Check for possible signs of a product fire in the cavity.</p>
<p>E107: COMs error</p> <p>UI displays; <i>E107 UI - IO Communication failure. Please contact your Merrychef service partner to resolve.</i></p>	<p>E107 observed in the event log</p>	<p>Ensure cable connections are secure, especially the X523 connected cable between the IO and the UI boards.</p> <p>Replace the Communication cable between the UI and IO boards as required.</p>
<p>E108: UI uSD FAILED</p> <p>UI displays; <i>E108 UI SD card error. Please contact your Merrychef service partner to resolve.</i></p>	<p>Missing or corrupt uSD card</p>	<p>Check the uSD card is correctly in place on the UI board.</p> <p>Replace uSD card.</p> <p>Ensure the correct uSD has been inserted to the UI, an easy mistake to make if the UI is replaced, don't forget to transfer the uSD from the old UI to the new UI.</p> <p>Loading of new up to date firmware is a must.</p>
<p>E109: IO PM Error</p> <p>UI displays; <i>E109 IO PM error. Please contact your Merrychef service partner to resolve.</i></p>	<p>The PM code is incorrect for the IO board</p>	<p>Check the PM chip is correctly in place on the IO board.</p> <p>Replace PM chip.</p> <p>The UI has a dedicated part number on the PM chip, which is unique for UI board. Ensure the correct PM chip has been inserted to the IO board, an easy mistake to if the IO board is replaced, don't forget to transfer the PM from the old IO to the new IO board if replaced.</p> <p>Loading of new up to date firmware is a must.</p>
<p>E110: IO VERSION CONFLICT</p> <p>UI displays; <i>E110 IO firmware error. Please contact your Merrychef service partner to resolve.</i></p>	<p>Incompatible firmware versions on the IO & UI boards. Can occur on replacement of either boards or during incorrect loading of firmware.</p>	<p>Download the up-to-date firmware from merrycheftechnical.com</p> <p>Load the latest firmware on to the oven. Do not switch off or interrupt until the loading process of all files has completed.</p> <p>In the event of a continued issue, replace both the IO PM and reload the firmware.</p> <p>Ensure there are no microwave leaks present around the control boards.</p>

<p>E111: Cavity Sensor Failure</p> <p>UI displays; <i>E111 Cavity Sensor Failure. Please contact your Merrychef service partner to resolve.</i></p>	<p>Cavity thermocouple damaged or unplugged (open circuit).</p>	<p>Check that the thermocouple is correctly fitted and secure on to the IO board connection X530.</p> <p>If the thermocouple generates erratic values, or is more than 25°C out of range, it will need to be replaced if the connection is in good condition and intact.</p> <p>If the fault reoccurs after replacing the thermocouple, replace the IO board.</p> <p>Check the error log. If the cavity temp reads 328°C the sensor was open circuit or not connected. A closed circuit will register the IO board temperature and will not generate the E111 error.</p>
<p>E112: IO BOARD TEMP SENSOR</p> <p>UI displays; <i>E112 IO Board Temperature sensor failure. Please contact your Merrychef service partner to resolve.</i></p>	<p>Ambient temperature sensor failure on the IO board</p>	<p>IO board failure. Replace IO board (Don't forget to remove the old PM chip and insert into the new IO board). Download the up to date firmware from merrycheftechnical.com and load on to the oven if required</p>
<p>E113: MAGNETRON ON WITHOUT REQUEST</p> <p>UI displays; <i>E113 Microwave On Without Request. Please contact your Merrychef service partner to resolve.</i></p>	<p>A current draw >1A detected on the IO board when the microwave circuit is switched off</p>	<p>IO board failure. Replace IO board (Don't forget to remove the old PM chip and insert into the new IO board). Download the up to date firmware from merrycheftechnical.com and load on to the oven</p>
<p>E116: Heater Not Responding</p> <p>UI displays; <i>E116 Heater not responding. Please contact your Merrychef service partner to resolve.</i></p>	<p>The oven asked for heating, but did not reach 100°C within 30 minutes</p>	<p>Check all the connections are in good condition and secure, from the incoming power supply through the Filter, Fuses F3 & F4, IO board and the heating element. The heater element rarely fails, checking all of the connections first is imperative.</p> <p>Ensure you counter hold the rear bolt of the element connections before tightening the front nut on the element.</p> <p>Lastly replace IO board</p>

<p>E117: RH Microwave overheat</p> <p>3 different error states, see solution 'UI displays:</p>	<p>The safety thermostat circuit (12vdc) is open circuit - IO connections X513.</p>	<p>Check the connections on the cavity overheat thermostat and IO board X513. Check the continuity of magnetron overheat thermostat. Check magnetron overheat thermostat LED16 on the IO board. The magnetron overheat thermostat should automatically reset once it has cooled down. A magnetron overheat is typically caused by a lack of cooling. Check the board temperatures in the event log to determine the cabinet air temperature at the time of the failure. Check the magnetron cooling fins (heat sink) are clean and free from dust, debris and grease build up, clean as required. Sufficient cooling is required, please ensure all panels are fitted correctly and do not have any cooling leakages from around the panel work. Check the cooling fan operation. Check / clean the air filter. Check the air curtain at the front of the unit for sufficient cooling. NOTE: If the magnetrons are tested without the ovens panels in place, which is NOT RECOMMENDED, the lack of air flow will cause the magnetron(s) to overheat and cause the magnetron overheat thermostat(s) to open circuit. The panels are designed to guide the cooling air sufficiently through the cooling fins in a forced airflow manner.</p> <p>UI displays:</p> <ul style="list-style-type: none"> • Message 1 if Mag stat >125°C, open circuit, Pre air filter removal <i>"E117 Magnetron overheat detected. Please remove, replace and clean the air filter located below the door"</i> • Message 2 if Mag stat >125°C, open circuit, <2minutes, post air filter removal <i>"Magnetron overheat recovery, Oven Cooling, please wait.... "</i> • Message 3 if Mag stat <125°C, closed circuit, <2minutes, post air filter removal the oven power cycles and returns to normal operation. <p>Restart button displayed</p>
<p>E118: LH Microwave overheat</p>	<p>The safety thermostat circuit (12vdc) is open circuit - IO connections X514.</p>	<p>Check the connections on the cavity overheat thermostat and IO board X514. Check magnetron overheat thermostat LED18 on the IO board.</p> <p>See E117</p>
<p>E-1 Unknown Error</p>	<p>Internal error</p>	<p>Download the up to date firmware from merrycheftechnical.com and load on to the oven.</p>
<p>E0: X510 jumper is missing</p> <p>UI displays; <i>E-1 Insert X510 jumper into correct position</i></p>	<p>Jumper missing on replacement of new IO board</p>	<p>Install a jumper across the front two pins of connection X510 on the IO board. If fault remains, new IO board required.</p>

Warning Event / Error Codes generated during operations:

Error	Problem	Solution
E84: Invalid date <i>Event log only</i>	Invalid date detected at start-up	Enter correct date and time in settings. For repeated events, download the up to date firmware from merrycheftechnical.com and load on to the oven.
E98: Incomplete cleaning <i>Event log only</i>	Cleaning sequence not completed by operator	Complete cleaning process as instructed.
E99: Air Filter Override <i>Event log only (for display see solution)</i>	Operator selected continue when filter was removed (filter microswitch was open circuit)	Check filter magnet, filter microswitch & connections Operator warning message = "Air filter removed. Please replace the air filter to continue. <i>(By selecting cancel and overriding the air filter monitoring this will be logged.)"</i>

Information Event Codes:

Error	Problem	Solution
E81: Firmware updated <i>Event log only</i>	UI or IO Firmware has been updated	Solution not required
E82: menu updated <i>Event log only</i>	Menu file has been updated	Solution not required
E86: Soft Power On <i>Event log only</i>	Touch screen on switch used.	Solution not required if events correspond with normal operation.
E87: Completed Cleaning Sequence <i>Event log only</i>	Cleaning sequence completed.	Solution not required if events correspond with normal operation.
E100: Main Power On <i>Event log only</i>	IO board supplied with 12V once mains power is switched on.	Solution not required if events correspond with normal operation.

Error Codes generated during recommission test:

E89: Recommission Cooling Test Failed	User input 'X' (to confirm not working) or timed out
E90: Recommission Convection Fan Test Failed	User input 'X' (to confirm not working) or timed out
E92: Recommission Heater Test Failed	<12K cavity temperature rise in 45 seconds
E93: Recommission Magnetron Test Failed	<1.25A current draw recorded on either magnetron
E94: Recommission Filter In Test Failed	No user action registered within 10 seconds. Filter microswitch signal remained open circuit, check filter microswitch & connections
E95: Recommission Filter Out Failed	No user action registered within 10 seconds. Filter microswitch signal remained closed circuit, check filter microswitch & connections
E96: Recommission Door Close Failed	No user action registered within 10 seconds. Door switch circuit remained open circuit, check door switches & connections
E97: Recommission Door Open Failed	No user action registered within 10 seconds. Door switch circuit remained closed circuit, check door switches & connections

Additional Errors / Faults

Error	Problem	Solution
Door open	Door open continuously displayed when the door is closed	Check fuses F5 & F6, if blown replace door switches Check door switches are adjusted correctly Check oven door hinges are fitted / working correctly Check all wiring and connections Check L1 is present on twin phase ovens
No USB Memory detected	Unable to read inserted USB Memory	Incorrectly formatted USB Memory. Re-format and re-load files. Slow key, or large file, allow further time for oven to read USB Memory.
Components not operating correctly	Components not operating correctly in diagnostic view	Check shunts are correctly fitted in X515 & X516 on the IO Board.

 **5.4 Safe working when testing components**

 **For your safety when testing oven components**

Before starting oven tests, familiarize yourself with the rules and hazard warnings in section 2 'For your safety', specifically section 2.14 'Safe working when testing components'.

5.5 Requirements

 **Equipment required for testing the appliance**

HV Capacitor discharge tool Portable Appliance Tester (P.A.T.) Digital Multi-Meter (D.M.M.) Proprietary voltage detector Electrical lock out tools & equipment Megger / similar 500 V d. c. Insulation tester Microwave detection / leakage meter (calibrated) Temperature reader (calibrated) Microwave safe 600 ml glass beaker Microwave safe 2 litre container	5.5 mm socket wrench Torque wrench Door Spacer Kit 4mm / 2mm 1000 volt rated general hand tools 1000-volt proof insulated rubber gloves PPE
---	--

5.6 Testing selected components (casing mounted)

 **Technical advisory notice: PAT testing of Merrychef ovens**

While testing with a Portable Appliance Tester (PAT) is not an automatic requirement for the Merrychef commercial combination microwave oven models, the following notice is to advise on this testing in addition to the following instructions as deemed necessary.

If the customer requires PAT testing of the Merrychef equipment we suggest this is limited to a) earth continuity and b) insulation resistance (measured at ~ 500 V DC). All Merrychef commercial combination microwave ovens are classified as CLASS 1 for the purpose of testing.

Should it still be deemed necessary by the customer to perform an Earth Leakage test, the following advice should be adhered to. Note that not all PATs are capable of just measuring the leakage or allow you to set a pass limit and therefore may not be appropriate for this test.

 **WARNING**

High leakage current

Merrychef appliances are fitted with radio interference filters and inverter circuits which cause an increase in leakage current. The PAT may indicate an erroneous failure condition depending on its internal "pass"/"fail" settings. Please refer to the revised limits which apply to the specific Merrychef oven model.

Model	Model maximum limit applied with radio interference filter fitted
conneX 12 & 16	10 mA

⚠ WARNING

Never touch the component under test while tests are being carried through.

- Call a trained authorized Merrychef service agent if the oven under test still fails in order to check all earth connections and disconnect the radio interference filters before repeating the test if required.

■ Earth/insulation test

Check that the following requirements have been met:

- The appliance has been disconnected from the power supply and protective measures have been taken to ensure the power cannot be switched on again.



1. Connect the mains lead from the appliance to a portable appliance tester



2. Connect the earth from the portable appliance tester to the equipotential bonding point on the oven.

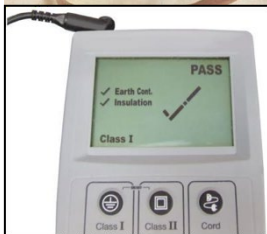

3. Place the portable appliance tester in an open area, such as the floor, away from any persons.

Perform a Class 1 test in accordance with tester instructions.

- A PASS indicates the oven earthing circuit is functioning correctly.
- If a FAIL is indicated (i.e., unit exceeds maximum limit), remove the casing of the appliance and check ALL earth connections. Then repeat the Class 1 test.

⚠ WARNING

Never operate an appliance that has failed this test as it could be potentially dangerous.

■ Service settings: Tests

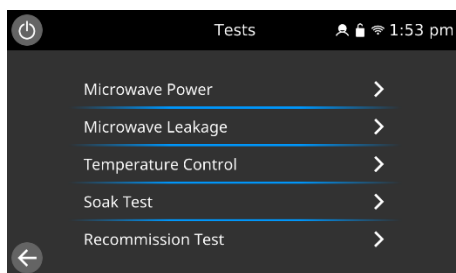
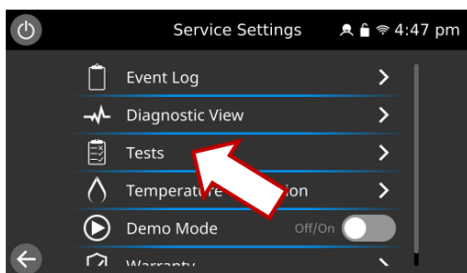

Enter Service Settings screen and select 'Tests'. For details see "Accessing the service information" section 5.1. Select the required individual test for the appliance to perform.

■ Microwave power test: measuring the microwave power output of the magnetron(s)

Check that the following requirements have been met:

- The appliance is cool. This test will not operate at a cavity temperature of 100°C or above.

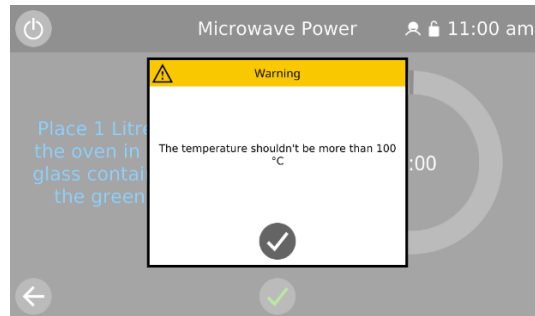

NOTE:

The power output is established under IEC 705 standard method which is only workable in laboratory-controlled conditions. The power output is also affected by line voltage under load, so this test is an approximation only.

1. Ensure the cavity is close to ambient temperature.
2. Enter the Service Settings / Tests.
3. Fill a microwave safe container (glass or plastic) with one litre (1.78 pints) of cool tap water, ideally at 20°C (68°F).
4. Measure and record the water temperature in the container using a thermometer capable of reading $\pm 0.1^\circ\text{C}$ increments.
5. Place the container centrally into the cavity.
6. Select 'Microwave Power' from the service settings tests (microwave power 100% for 60 seconds, convection fan at 10%).

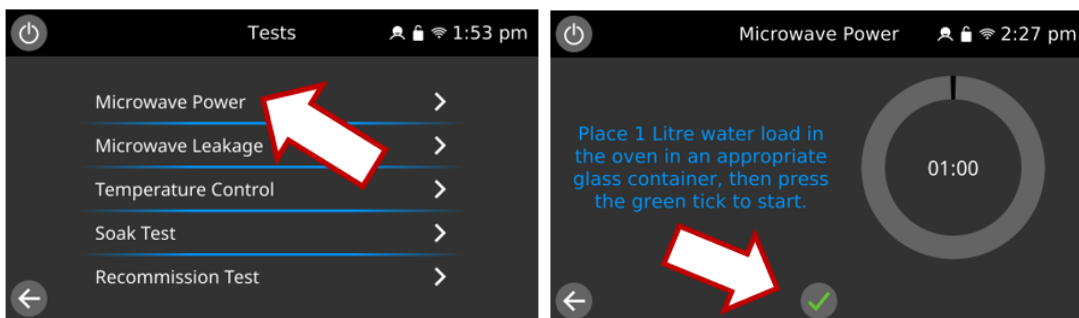

1. When the countdown has finished, remove the container from the cavity. Immediately stir with a plastic implement and measure the water temperature.
2. Calculate the temperature rise of the water (end temperature minus the start temperature).
 - The temperature rise should be 14.3°C (25.7°F) $\pm 10\%$ for the 1000W (1 magnetron) variant.
 - The temperature rise should be 28.5°C (51.4°F) $\pm 10\%$ for the 2000W (2 magnetrons) variant.
 - If the temperature rise is outside these limits repeat test and/or check the microwave circuit and components. A low reading could be caused by the water container absorbing the energy, in which case an alternative container should be used.
 - Replace the faulty HV component if required (see High voltage components in section 5.8).

Note: Opening the door during the test will stop the test. Reselect the test to run again.

3. On completion of the test, specify the result by selecting 'Pass' or 'Fail'.

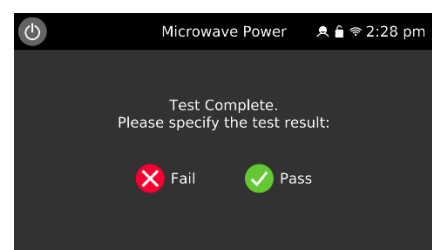

Microwave leakage test

Check that the following requirements have been met:

- The appliance is cool.
- This test will not operate at a cavity temperature of 70°C or above.

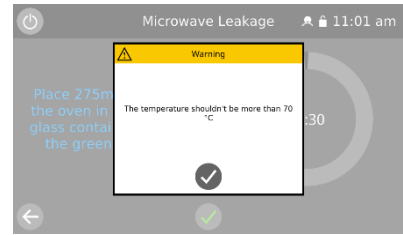

Follow these instructions when measuring:

- Make sure that the survey meter you are using has been calibrated and is suitable for measuring frequencies of 2,450 MHz.
- Do not exceed meter full scale deflection. The leakage meter should initially be set to the highest scale, then adjusted down as necessary to ensure that low readings are measured on the most sensitive range.
- To prevent false readings, hold the probe on the grip provided and move at 2.5 cm/second.
- Always hold the probe at right angles to the oven and point of measurement, ensuring the probe sensor is reading 50 mm from the test area.
- The leakage should not exceed 5 mW/cm².

1. Add 275 ml of cold water into a 600 ml microwave safe container.
2. Place the 600 ml container in the centre of the cavity and close the door.
3. Enter Service Settings / Tests and select 'Microwave leakage' from the appliance tests (microwave power 100% for 30 seconds, convection fan at 10%).

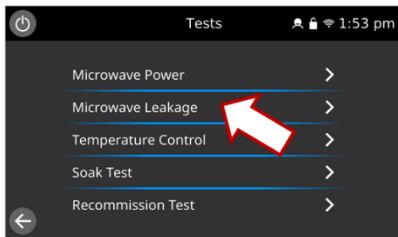

4. Set the leakage meter to the appropriate scale/range.
5. Move the survey meter probe across all casework joins and vent areas including those marked in yellow, shown opposite.

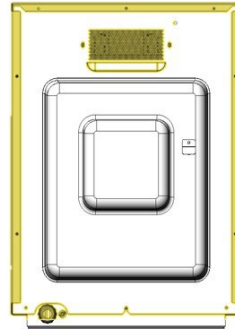

6. When the microwave leakage test stops after 30 seconds, change the water and re-select the test to continue.
7. Select the return arrow on the display to stop the test at any time.
8. Readings must be below 5mW/cm², ideally zero as there should be no microwave leakage and corrections should be made if any leakage is detected above 0.5mW/cm².

⚠ CAUTION:

If a level greater than 5mW/cm² is observed, don't use the appliance until repaired.

9. Note any leakage that is observed in terms of the level and position on the appliance. Keep this information with the service documentation.
10. On completion of the test, specify the result by selecting 'Pass' or 'Fail'.

Note: Opening the door during the test will stop the test. Reselect the test to run again.

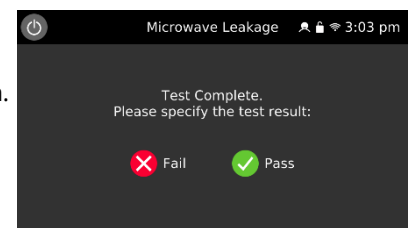

Temperature control test

1. Place a calibrated temperature probe in the centre of the cavity.
2. When selected the oven heats up to 275°C.

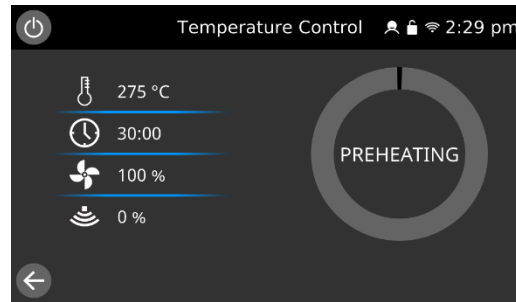
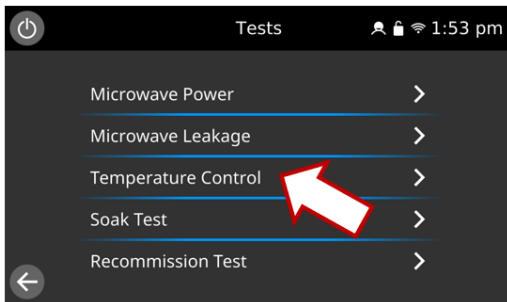

3. The preheat status can be viewed by selecting temperature.

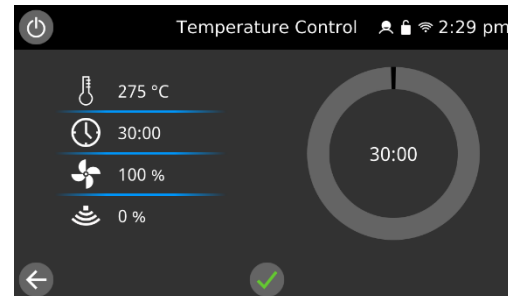
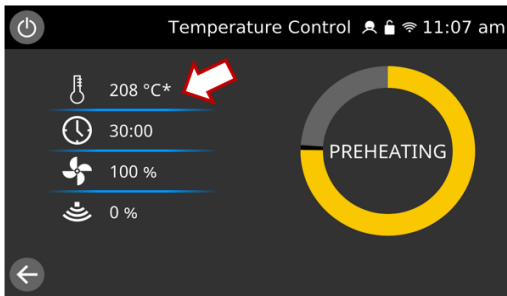

4. Once the oven reaches temperature, select the green tick to start. The oven will run on heat only, convection fan at 100%, for 30 minutes cycling around the maximum cavity temperature of 275°C.
5. Independently monitor the cavity temperature.
6. On completion of the test, specify the result by selecting 'Pass' or 'Fail'.

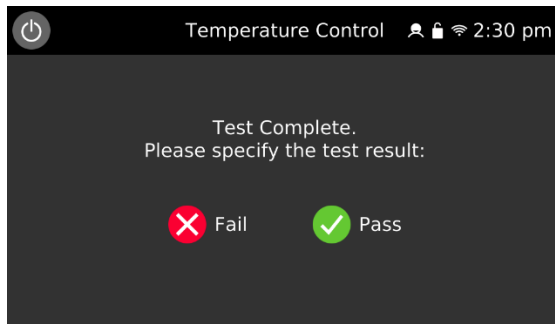

Note: Opening the door during the test will stop the test. Reselect the test to run again

This test only generally recommended for workshop activities.

■ Soak test: checking the cavity integrity

1. When selected, the oven heats up to 275°C.

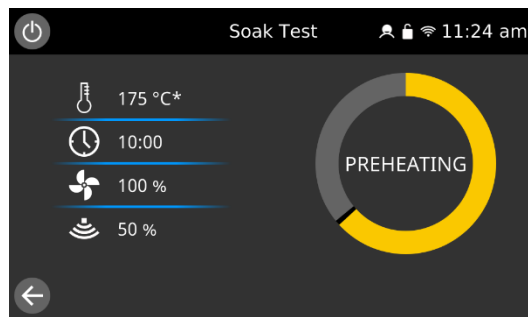

2. Once the oven reaches temperature (>265 °C), add 1 litre of water in an appropriate covered glass container.
3. Select the green tick to start. The oven will run for 10 minutes cycling around a cavity temperature of 275°C, 50% microwave power and 100% convection fan.

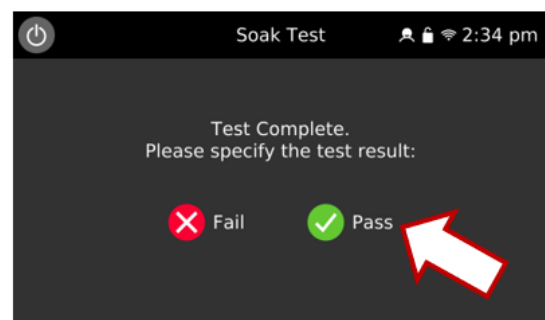
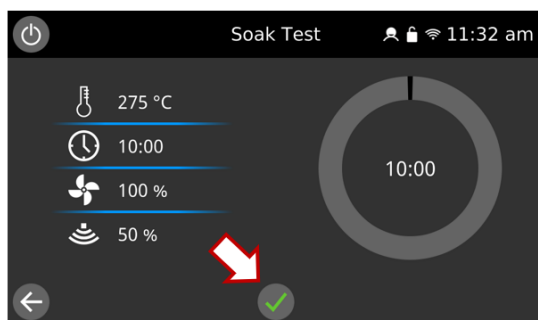

4. During the test carefully check the appliance casing, joints, and door seal for signs of steam or water escaping from the cavity. If necessary, rectify any leaks and repeat the test.
5. On completion of the test, specify the result by selecting 'Pass' or 'Fail'.
6. Safely remove the container of water from the cavity.

Note: Opening the door during the test will stop the test. Reselect the test to run again.

This test is only generally recommended for workshop activities.

■ Recommissioning test: checking the appliance operation

The recommission tests are performed following the completion of a planned maintenance visit, or repair to ensure that the appliance is working correctly before handing back to the customer.

Some of the tests have a countdown timer, where failing to carry out a test within the time limit will cause a test failure and the recommission test will have to be restarted.

If the 'recommission test' tab is greyed out, the oven is above 200°C and will not allow to the test to commence until the oven is cooled down.

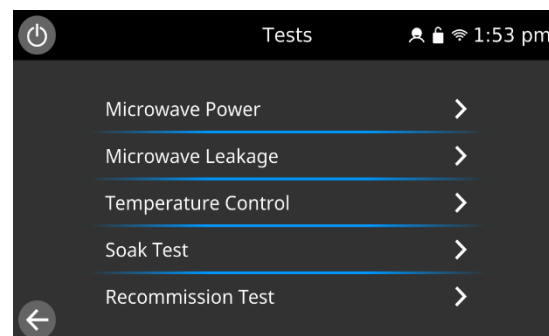
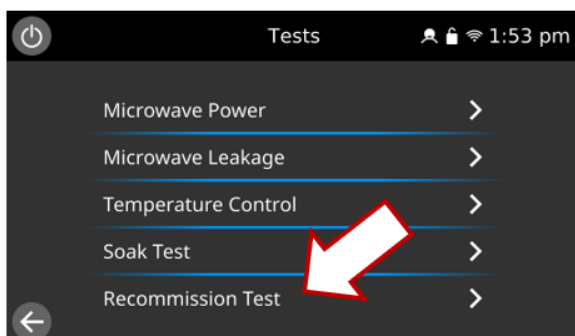

1. Ensure the cavity is close to ambient temperature.
2. Enter the Service Settings / Tests and select 'Recommission Test' from the appliance tests.

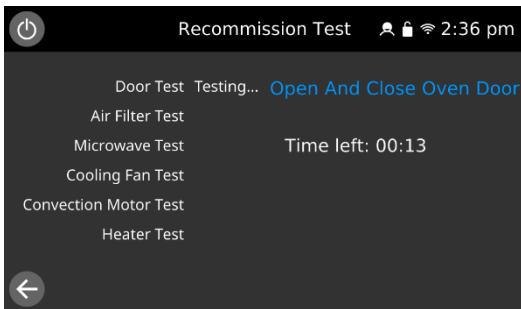

The test will check the appliance in the following order:

- Door switch operation
- Filter switch operation
- Microwave circuits
- Cooling fan operation
- Convection fan operation
- Heater circuit

The test will stop at any point a failure is detected.

After a test has successfully passed, when requested select the green check mark to continue. Selecting the red check mark as a result of a failure will terminate the recommission test sequence.

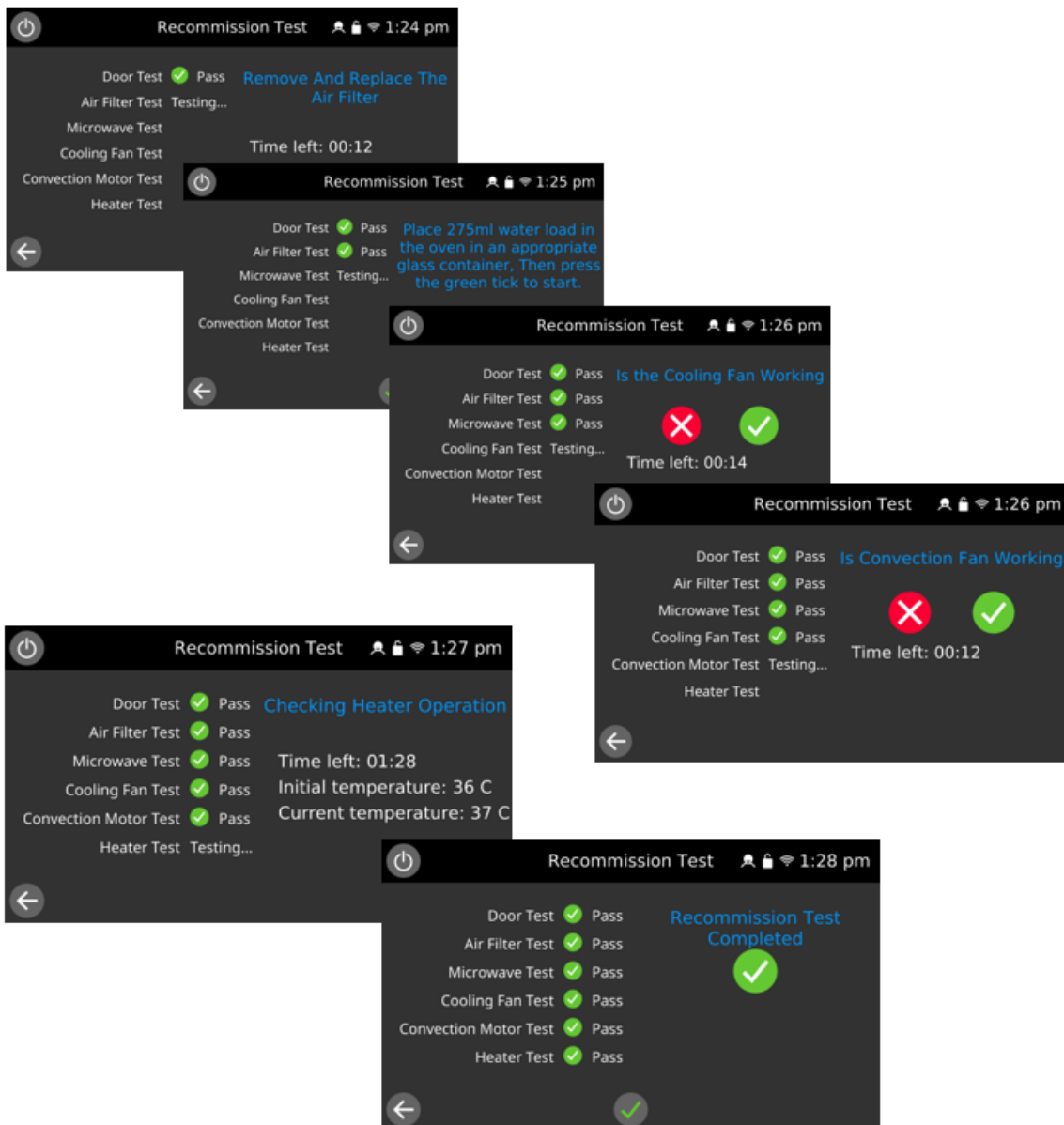

Note: If the door is opened during the microwave circuit test, the process will stop and record a failure.

3. When all the tests have been successfully performed the display shows the recommission test has passed. Select the green check mark to confirm.
4. In the event of a recommission test failure, the detail will be recorded in the Error Log. Rectify any error and repeat the recommission test.

■ Commissioning the oven after service/repair/testing

Before finishing a service call, recheck the following points:

1. Run the recommission tests to ensure the oven is functioning correctly and the touch screen is working.
2. Microwave emissions are below the permissible limit of 5mW/cm², ideally <1mW/cm².
3. The power output of the oven is checked in accordance with the procedure.
4. Earth leakage is within permissible limits.
5. The oven has a correct air gap of 50 mm / 2 inches above. Air flow should not be restricted at the front, top or rear of the oven.
6. Complete the service report.

Complete the following checks after the oven has been serviced/repared/tested before connecting to the mains electricity power supply:

1. All internal electrical connections are correct (see "Electrical circuit diagrams" in section 7).
2. All wiring insulation is correct and is not touching any sharp edges.
3. All grounding connections are electrically and mechanically secure.
4. Any removed heat tape or cable ties are refitted/replaced.
5. All door safety interlocks are secure and mechanically sound.
6. The door activates all the door interlock switches and in the correct order.
7. The door operation is smooth.
8. The door seal is in good condition and seals against the cavity.
9. The casing is securely refitted with no trapped wires and all the fixing bolts are refitted.

■ Service Settings : Temperature Calibration Check / Recalibration

Tools required:

- 1 x Calibrated digital thermometer
- 1 x Temperature probe on a heat sink

1. Place temperature probe in the centre of cavity
2. Ensure the oven is in 'Full Serve Mode'
3. Select 250°C oven temperature. If there is no preheat temp programmed appropriate for the oven test, a new temperature must be programmed into a spare location (250°C).
4. Wait for the oven to reach the preheat temperature of 250°C.
5. Once the preheat temperature has been achieved, press the chef's hat 'recipe creation' on the easy-touch screen.
6. Select 10 minutes run time, 100% convection fan and 0% microwave.

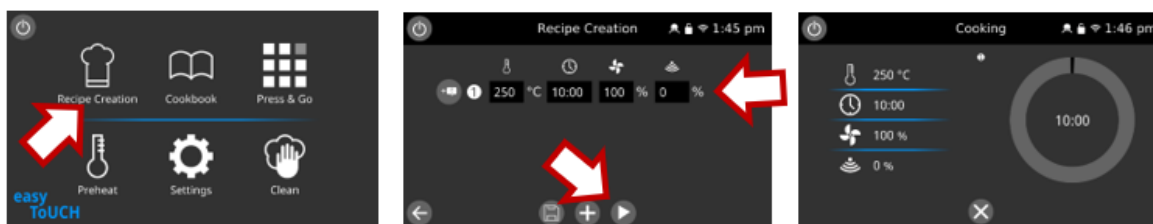

7. Press the play button at the bottom of the screen
8. When the timer has 30 seconds remaining press the temp icon the temperature the oven sensor thinks the cavity has reached will be displayed prefixed with *
9. Compare the displayed temperature with the actual temperature shown on the digital thermometer. Recalibration will be required, and should be carried out swiftly, if the readings are outside the following guidelines;

Model	Preheat	Display	Thermometer	Action
conneX [®] 12 & 16	250°C	*255°C	251°C or higher	Recalibrate
			244°C or lower	Recalibrate
			245°C to 250°C	No action required

10. To recalibrate, promptly access 'Temperature Calibration' in the Service Settings

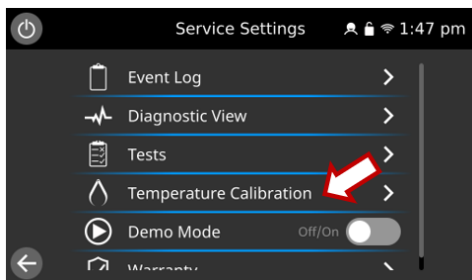

11. Enter the temperature on the keypad as displayed on the calibrated digital thermometer and press the enter.
12. The 'COMP:' temperature should now read the same as the entry.
13. Monitor the 'RAW' oven temperature and compare to the calibrated digital thermometer. Repeat steps 11 & 12 if the calibration is requires further adjustment.
14. Once the calibrated digital thermometer reading is in alignment with the RAW temperature, select the green check mark at the bottom of the screen and then pass on the test complete screen.
15. Repeat the calibration check, points 5 to 9. Retesting to check that the cavity temperature reading is now within the recommended guidelines.

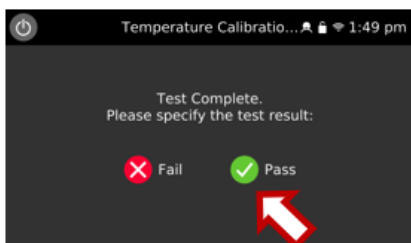
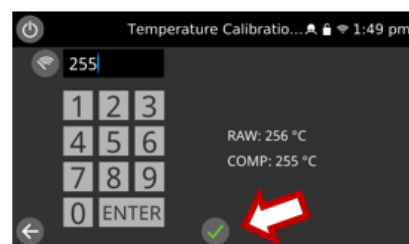
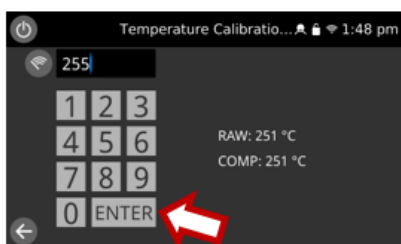
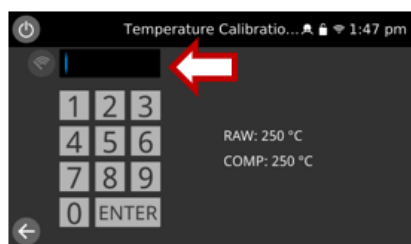

If the temperature reading is unstable and not calibrating correctly:

1. Disconnect and isolate the appliance from the electricity supply and Lock off, see section 2.14 'Safe working when testing components'.
2. Take protective measures to ensure the power cannot be switched on again.
3. Allow the appliance to cool down.
4. Remove the side and top panels of the casing.
5. Discharge the capacitors and prove dead.
6. Check the cavity temperature sensor wire and connections.
7. If the wire and connections are correct and in good condition, replace the cavity temperature sensor (see Section 6.17. – Overview - further components).
8. Refit the panels of the casing.
9. Switch ON the appliance and repeat the test procedure as described above.
10. If the temperature is still unstable repeat steps to make safe and replace the IO board (see Section 6.10 Replacing the IO board).
11. Refit the panels of the casing.
12. Switch ON the appliance and repeat the test procedure as described above.

5.7 High voltage components (casing removed)

High voltage transformer test

Ensure the following requirements have been met before starting the test:

1. The appliance has been disconnected from the power supply and protective measures have been taken to ensure the power cannot be switched on again.
2. The appliance is cool.
3. The high voltage capacitors are discharged before commencing work.
See section 2.15 'How to discharge the conneX HV'.
4. The casing of the appliance has been removed.

Note: the rear transformer on the X12 connects to the right hand HV components

⚠ DANGER

High voltages and significant currents are present at the high voltage capacitor and HV Circuit.

It is very dangerous to work near this part when the oven is on.

NEVER make any electrical measurements on the high voltage circuits, including the magnetron filament, whilst the oven is connected to the mains power supply.

1. Remove all connections from the transformer.
2. Using a Digital Multi-Meter (DMM), check the resistance of the windings.
Results should be as follows:

- 200 – 230V Transformer

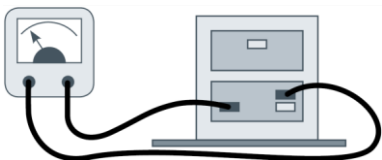

3. Mains winding between tags, approx.;
- | | |
|-------------|--------------|
| 0 to 230; | 0.6 Ω |
| 0 to 200; | 0.5 Ω |
| 200 to 230; | 0.1 Ω |

- 208 – 240V Transformer

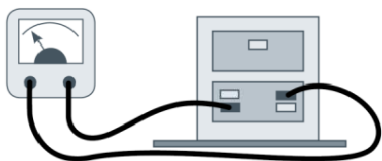

3. Mains winding between tags, approx.;
- | | |
|-----------------|--------------|
| 0 to 200/208; | 0.5 Ω |
| 0 to 220; | 0.6 Ω |
| 0 to 240; | 0.6 Ω |
| 208/208 to 220; | 0.1 Ω |
| 208/208 to 240; | 0.1 Ω |
| 220 to 240; | 0.1 Ω |

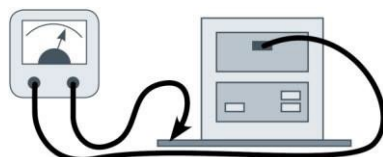

4. High Voltage winding, approx. 57 Ω .

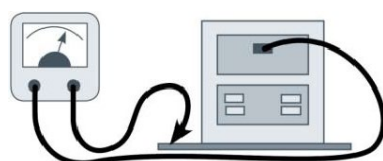

4. High Voltage winding, approx. 47 Ω .

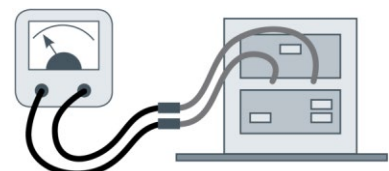

5. Filament winding between terminals, less than 1 Ω .

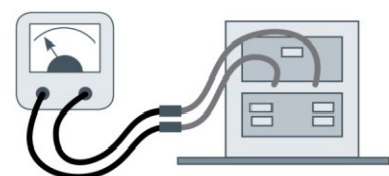

5. Filament winding between terminals, less than 1 Ω .

6. Using a megger/insulation tester, test the insulation resistance between:
 - Primary winding and chassis. Pass if reading is over 10 M Ω
 - Filament winding and chassis. Pass if reading is over 10 M Ω

NOTE: One end of the high voltage (secondary) winding is connected to the chassis, so this is not tested.

High voltage diode test

Ensure the following requirements have been met before starting the test:

- The appliance has been disconnected from the power supply and protective measures have been taken to ensure the power cannot be switched on again.
- The appliance is cool.
- The high voltage capacitors are discharged before commencing work.
See section 2.15 'How to discharge the conneX HV'
- The casing of the appliance has been removed.

⚠ DANGER

High voltages and significant currents are present at the high voltage capacitor and HV Circuit.

It is very dangerous to work near this part when the oven is on.

NEVER make any electrical measurements on the high voltage circuits, including the magnetron filament, whilst the oven is connected to the mains power supply.

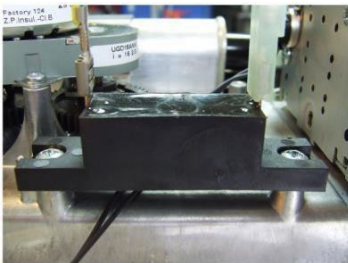

1. Remove both connections from the high voltage diode.
2. Using a megger/insulation tester, test for continuity in both directions.
Results should be as follows:
Open circuit both ways - FAIL
Conducts one-way only - PASS
Short circuit both ways - FAIL
Conducts one way, leaks the other - FAIL

High voltage capacitor test

Ensure the following requirements have been met before starting the test:

- The appliance has been disconnected from the power supply and protective measures have been taken to ensure the power cannot be switched on again.
- The appliance is cool.
- The high voltage capacitors are discharged before commencing work.
See section 2.15 'How to discharge the conneX HV'
- The casing of the appliance has been removed.

⚠ DANGER

High voltages and significant currents are present at the high voltage capacitor and HV Circuit.

It is very dangerous to work near this part when the oven is on.

NEVER make any electrical measurements on the high voltage circuits, including the magnetron filament, whilst the oven is connected to the mains power supply.

1. Remove all electric connections from the high voltage capacitor.
2. Using a Digital Multi-Meter (DMM), check for continuity.

Results should be as follows:

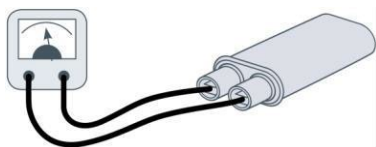

3. Connect the DMM to both terminals of the high voltage capacitor.
The test is passed if the DMM display reads approx. 10 MΩ.

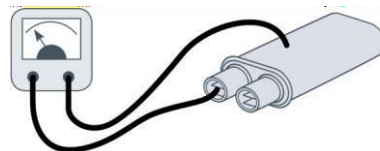

4. Connect the DMM to one terminal and the metal outer case of the high voltage capacitor.
The test is passed if the DMM display reads "open circuit".
Repeat the test for the other terminal and the metal outer case.

5. Using a megger/insulation tester, test the insulation resistance between both terminals and the metal outer case of the high voltage capacitor.
The test is passed if the megger/insulation tester display reads over 100 MΩ.

High voltage magnetron test

Ensure the following requirements have been met before starting the test:

- The appliance has been disconnected from the power supply and protective measures have been taken to ensure the power cannot be switched on again.
- The appliance is cool.
- The high voltage capacitors are discharged before commencing work.
- The casing of the appliance has been removed.

⚠ DANGER

High voltages and significant currents are present at the high voltage capacitor and HV Circuit.

It is very dangerous to work near this part when the oven is on.

NEVER make any electrical measurements on the high voltage circuits, including the magnetron filament, whilst the oven is connected to the mains power supply.

1. Remove all electric connections from the magnetron.
2. Using a Digital Multi-Meter (DMM), check for continuity.
Result should be as follows:

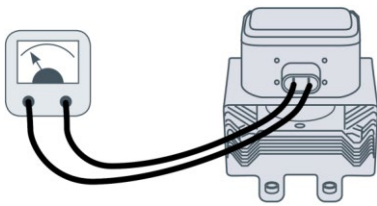

3. Connect the DMM to both terminals of the magnetron.
The test is passed if the DMM display reads $1\ \Omega$ or less.

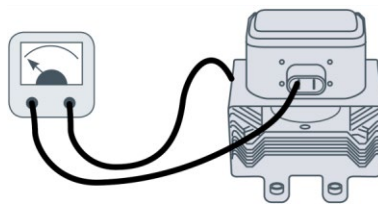

4. Using a megger/insulation tester connect to one terminal and the metal outer case of the magnetron. The test is passed if the megger/insulation tester display reads an infinite resistance, "open circuit". Repeat the test for the other filament terminal and the metal outer case.

5.8 Mains voltage components (casing removed)

Convection fan: motor

The convection fan motor is a 3-phase AC motor having a maximum speed of approximately 7000 rpm (approximately 5200 rpm 16A/13A ovens) controlled by a motor speed controller (VFD).

The windings are thermally protected. In the event of a thermal fault, the trip inside the motor (IP) will open circuit and cause the VFD to enter a fault mode.

Convection fan: motor speed controller

The convection motor speed controller provides a 3-phase AC switched mode drive to the convection motor and is controlled by a 0 to 10 Volt signal from the IO board (connection X519) on 30A ovens and a 0 to 7.5 Volt signal on 13A & 16A ovens.

This allows the motor to be adjusted from approximately 1400 rpm to 7000 rpm (5200 rpm) in steps of 1%.

- Door open, Approx. 1400 rpm (10% @ 1V).
- Door open (cleaning cool down), $>100^{\circ}\text{C}$ Approx. 5800 rpm (85% @ 8.5V). $>50^{\circ}\text{C}$ Approx. 3500 rpm (50% @ 5V).
- Door closed (not cooking), Approx. 2500 rpm (30% @ 3V).
- Door closed (heating up), Approx. 3500 rpm (50% @ 5V).
- Door closed (cooking), speed as specified by program or setting up to a maximum of 7000 rpm (100% @ 10V).

Convection fan: motor speed controller LED status display

The VFD contains a diagnostic indicator (Red LED) to display the drives operational status;

LED Drive Status	Flash rate	Additional details	Recovery
Normal Operation (Run)	On Continuously	Fan motor operating normally	10s
Overload (Hardware Current >10A)	1	Fan motor off (switched off in less than 1ms)	10s
Overload (Software Current >3.5A)	2	Fan motor off (switched off after 5s)	10s
Output Phase Missing	3	Fan motor off (switched off after 2s)	10s
Lock Motor	3	Fan motor off (switched off after 2s)	10s
Over Voltage (>275VAC)	5	Fan motor running in safe mode (1000rpm)	10s
Under Voltage (<150VAC)	6	Fan motor running in safe mode (1000rpm)	10s
P1 - P2 link wire missing	7	Fan motor off (switched off in 100ms)	10s
Onboard Fuse Blown	2 then 3	Fan motor off (switched off after 55ms)	10s

Convection fan: motor speed controller control voltages & link positions

Oven Variant	13A & 15A/16A	30A
Input %	0 - 10 Volts	
10	2	2
20	2.8	2.8
30	3.5	3.5
40	4.3	4.3
50	5	5
60	5.5	6
70	6	7
80	6.5	8
90	7	9
100	7.5	10

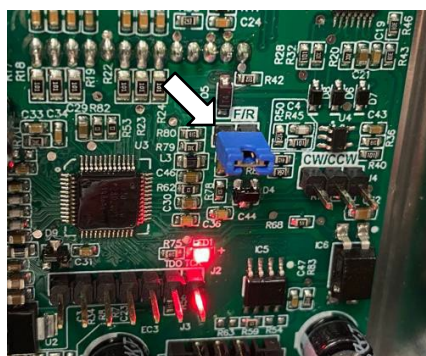

Link positions are factory pre-set based on the model of convection fan used in the conneX ovens. The link positions must not be altered without express instruction from Merrychef.

Convection fan: motor and motor speed controller tests

Ensure the following requirements have been met before starting the test:

- The appliance has been disconnected from the power supply and protective measures have been taken to ensure the power cannot be switched on again.
- The appliance is cool.
- The high voltage capacitors are discharged before commencing work.
- Anti-static precautions have been taken.
- The casing of the appliance has been removed.

Check the following:

1. All associated wiring and connections, from IO board X113 & X519 through the speed controller to the convection fan motor.
2. Convection fan motor thermal cut-out (IP), two black wires.
3. Convection fan motor rotates freely / not seized.
4. Convection fan motor winding resistances:
 - Blue-red 7.5 Ω ±10%
 - Red-yellow 7.5 Ω ±10%
 - Yellow-blue 7.5 Ω ±10%
 - Blue or red or yellow to earth (open circuit).
5. With the oven panels refitted and the oven re-connected to the power supply check the fan speeds using visual view in the service mode.

Finally, if all suitable precautions (including where necessary the provision of suitable protective equipment) have been taken to prevent injury;

Check the following:

6. Speed controller LED status
7. Electrical supply to the speed controller

5.9 KitchenConnect components

KitchenConnect connections

Optional Ethernet port between the UI ethernet loom connection (under the IO Board) and the rear panel lead socket. Wi-Fi connectivity built into the UI as standard.

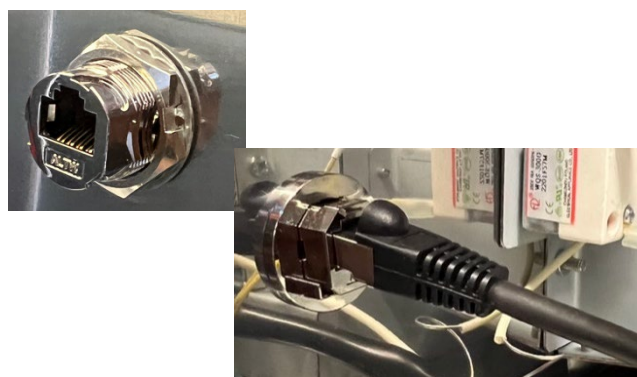
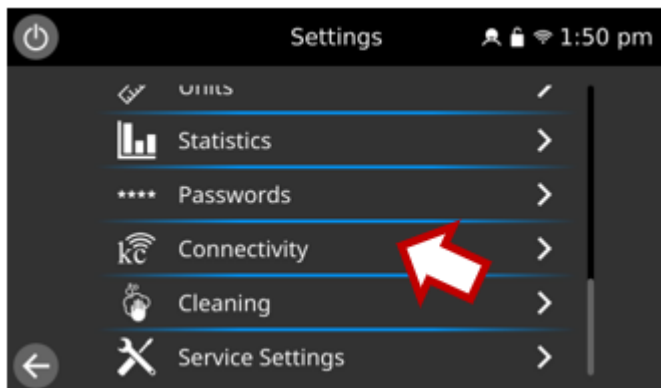

Connection details can be accessed from the settings menu.

6 Replacing components

6.1 Safe working when replacing appliance parts

For your safety when replacing appliance parts

Before starting service / repair work, it is essential that you familiarize yourself with the rules and hazard warnings specified in section 2 'For your safety', specifically section 2.16 'Safe working when replacing appliance parts'.

Tools required

- | | |
|---|--|
| HV Capacitor discharge tool | Torque wrench |
| Digital Multi-Meter (D.M.M.) | Stanley / retractable knife |
| Proprietary voltage detector | Sealant gun |
| Electrical lock out tools & equipment | Long handled |
| Door spacer kit (2 x 4mm & 2mm Spacers) | Pozidriv screwdriver PZ1 |
| M2 hex key socket | Long handled Pozidriv screwdriver PZ2 |
| M5.5 hex socket wrench / nut runner | Flat screwdriver or lever |
| M5.5 hex open / ring spanner | Pliers (or M14 ring spanner) |
| M7 hex socket wrench / nut runner | Two metal pins, 3mm diameter & 10mm long |
| M7 hex open / ring spanner | Two metal pins, 2 to 3mm diameter & 40mm or longer in length |
| M8 hex socket wrench / nut runner | Hammer (for removing pressed screws from a spare magnetron) |
| M10 hex socket wrench / nut runner | M3 hex key socket |
| M14 hex socket wrench / spanner | |

6.2 Overview

View: left hand side - X12

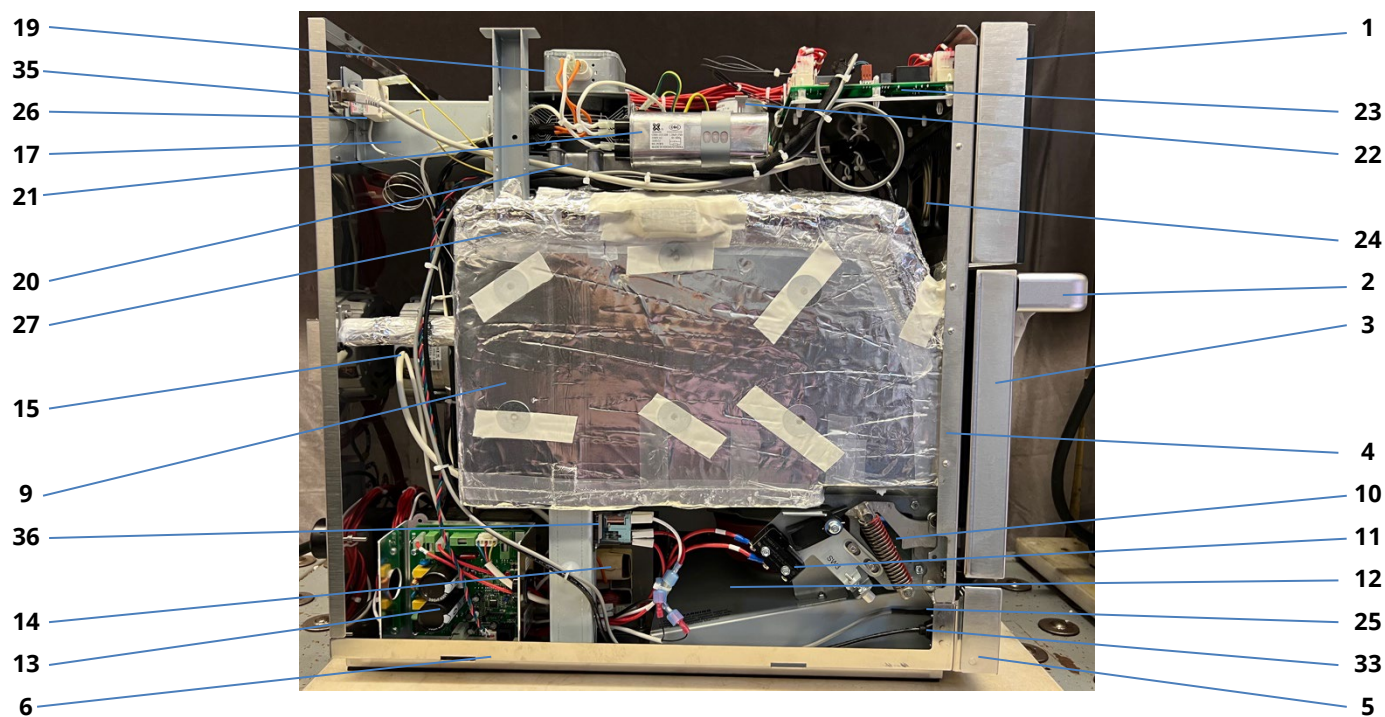

View: right hand side - X12

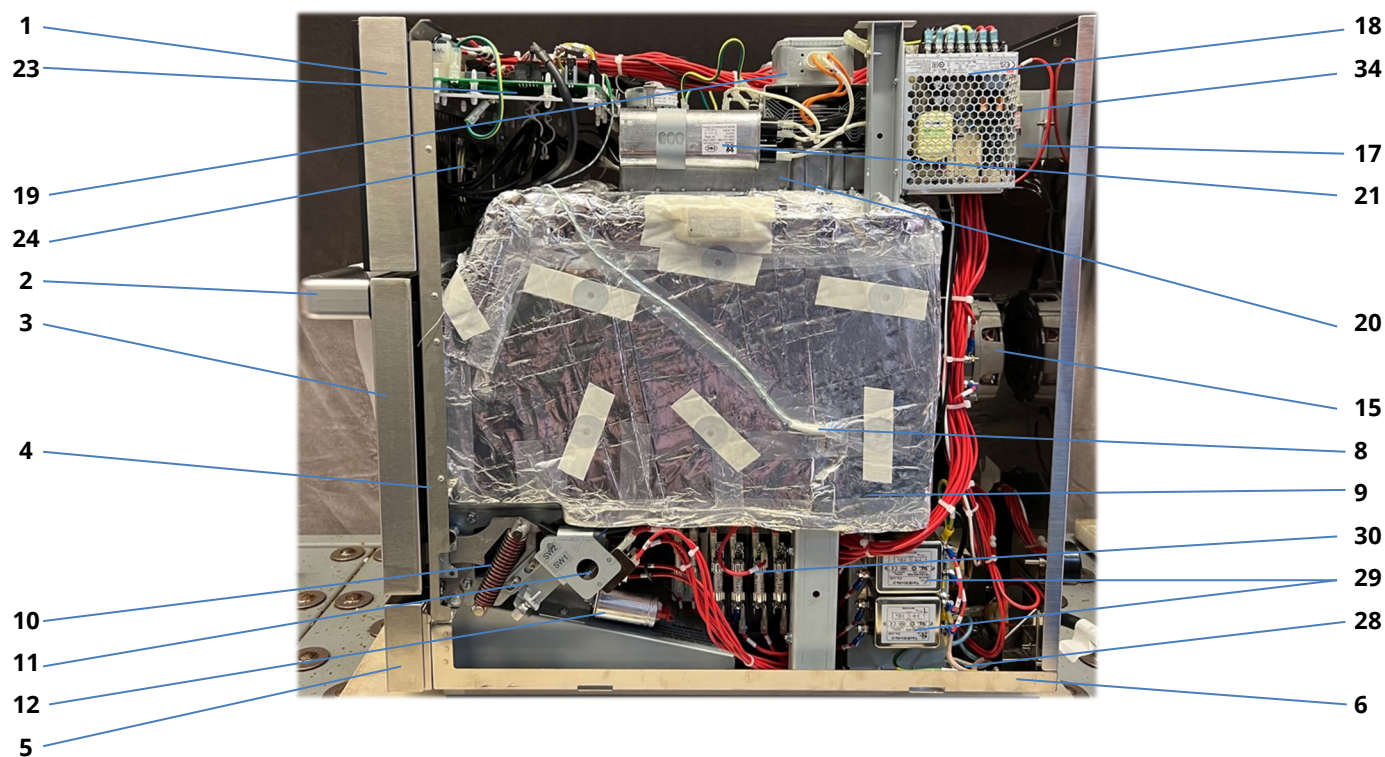

■ View: left hand side - X16

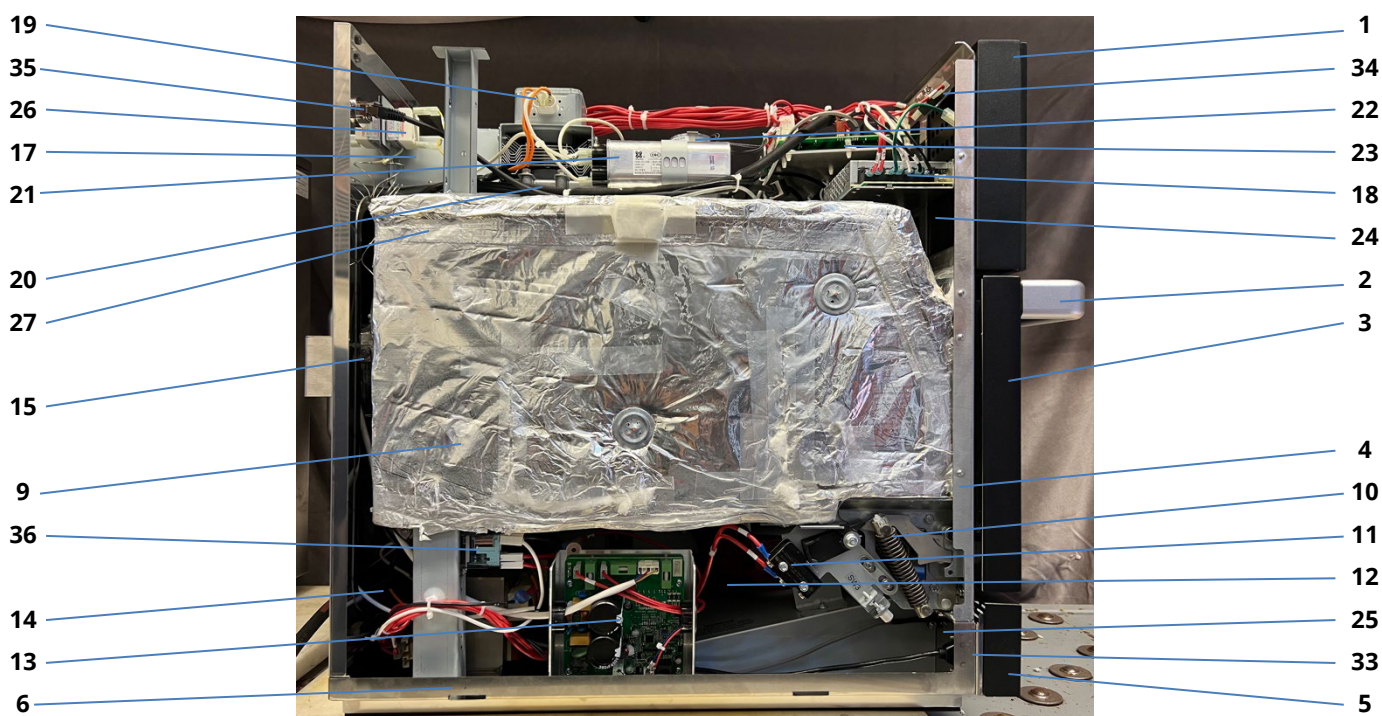

■ View: right hand side - X16

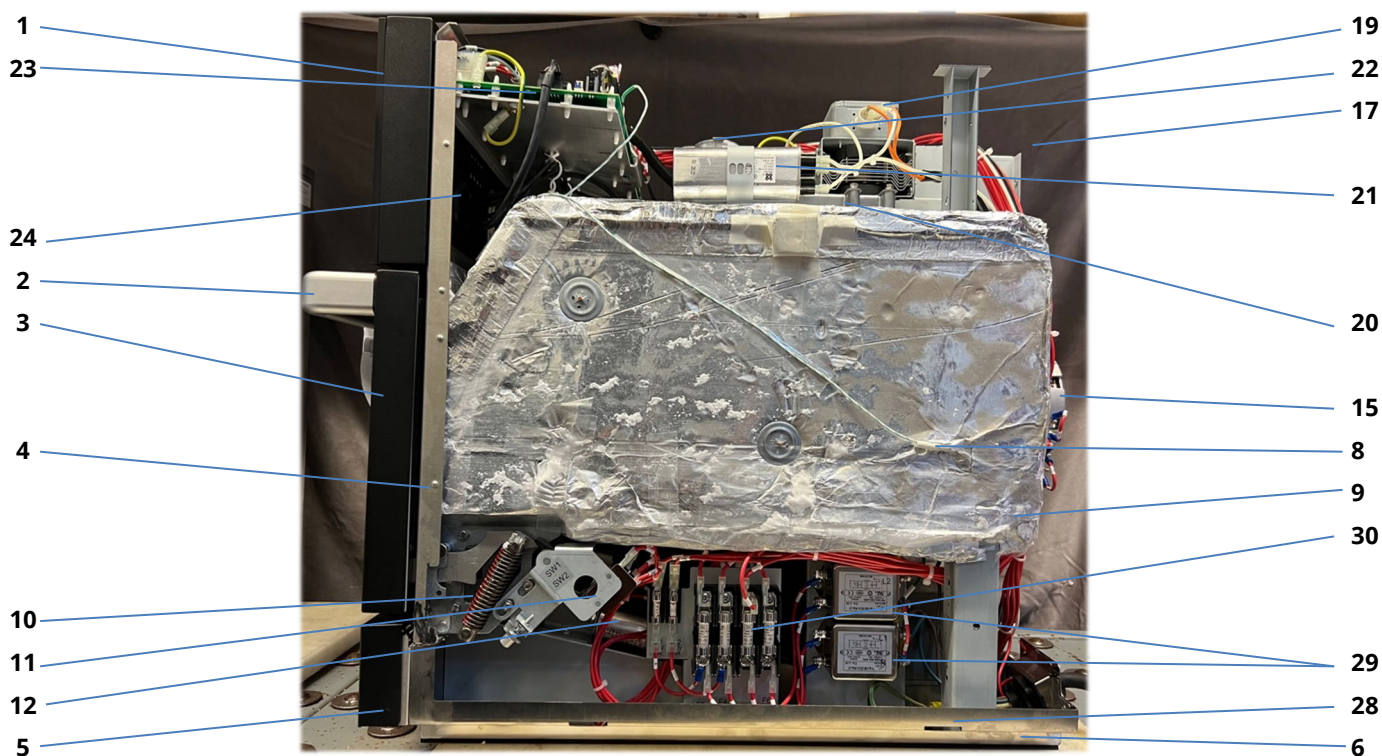

■ View: rear side

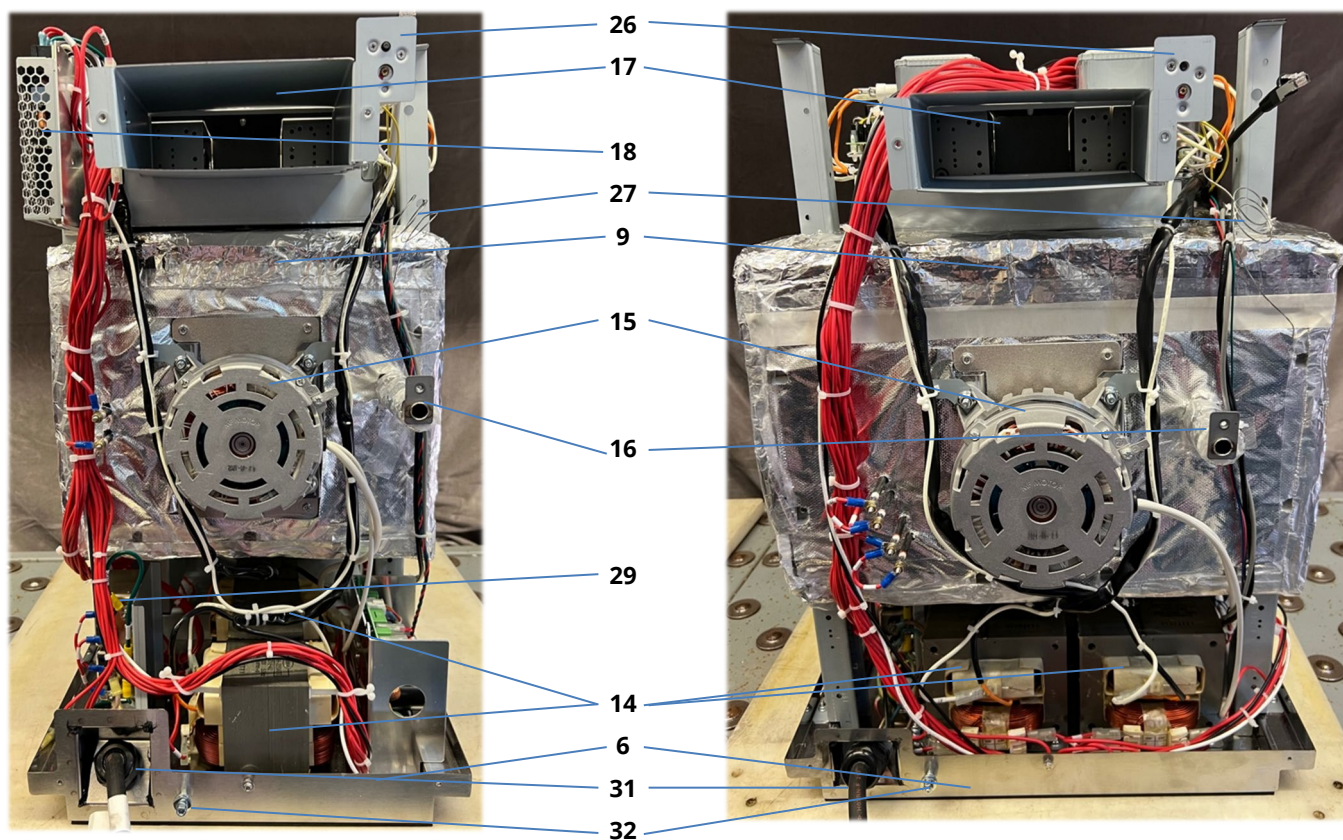

X12

X16

Component list

Item	Name	Function
1	Front panel	The front panel houses the touchscreen UI assembly
2	Door handle	Open the oven door using the door handle. Never use the door handle to lift the appliance.
3	Door cover panel	The door cover panel can be detached for accessing the door hinge arms.
4	Cavity Frame	The oven door and front panel are mounted on the cavity frame, with the top and side panels clipping on to the edges
5	Air filter faceplate	The faceplate can be tilted to access the air filter.
6	Base plate	The metal base plate carries all oven components.
7	Back panel	The back panel, fitted to the base plate & cooling duct, secures the oven top & side panels and provides ventilation of the oven interior.
8	Thermocouple	Provides the cavity temperature signal to the IO board
9	Cavity & Cavity Wrap	The insulated cavity (cooking chamber) for cooking food can be accessed by opening the oven door.
10	Door hinge assembly	The door hinges interact with the microswitches / interlocks.
11	Door microswitch(es) / interlock(s)	The microswitches / interlocks are connected to the door hinges and switch off the magnetron(s) when the oven door is opened.
12	Cooling fan	The cooling fan draws air through the air filter into the interior of the casing in order to cool the electrical components.
13	Convection (hot air) fan motor speed controller (VFD)	This component controls the speed of the convection fan motor depending on specific oven settings.
14	Transformer(s) (high voltage)	A high voltage transformer(s) feeds the HV microwave circuit.
15	Convection (hot air) fan motor	The convection fan motor is controlled by the speed controller and drives the convection fan for air flow within the oven cavity.
16	Exhaust pipe	The exhaust pipe leads excessive steam from the cavity to the cooling duct and the rear air outlet of the oven.
17	Cooling duct	The cooling duct directs heat generated by the magnetron(s) to the rear of the oven.
18	SMPS (low voltage - IO)	The low voltage (ELV) Switch Mode Power Supply module feeds the IO board.
19	Magnetron(s) (high voltage)	A magnetron generates microwaves.
20	Waveguide	A waveguide leads microwaves from a magnetron into the cavity. The HV Diode(s) is mounted on to the waveguide(s).
21	Capacitor(s) (high voltage)	The capacitor completes the magnetron circuit for required high voltage.
22	Stirrer motor(s)	A stirrer motor turns a stirrer distributing microwave energy in the cavity.
23	IO Board	The IO board controls all electrical oven components.
24	Loudspeaker	The loudspeaker produces sound signals (e.g., cooking process completed).
25	Intake Air Filter Microswitch	Closed circuit when the air filter is correctly installed
26	Cavity overheat thermostat (cavity overheat stat)	The thermostat continuously monitors the temperature in the cavity and prevents it from overheating.
27	Cavity overheat thermostat capillary	Connected to the side of the cavity, underneath the cavity wrap, for the cavity overheat thermostat temperature monitoring
28	Protective earth	Provides a chassis earthed point at the metal base plate of the oven.
29	Electromagnetic Compatibility (EMC) Filter	EMC filters reduce the transfer of electromagnetic noise to and from the mains power supply.
30	Mains supply fuses	The fuses protect the oven from excessive current draw.
31	Mains power supply cable	For connecting to the kitchen mains power supply.
32	Equipotential bonding connection	This is an electrical connection point to ensure that the frame of oven and any external conductive components are at an equal (or practically equal) potential when connected.
33	USB Port	USB socket for uploading and downloading firmware & files
34	VFD supply fuse	3A fuse VFD supply protection from excessive current draw
35	Ethernet port	Ethernet port for network connection
36	VFD safety relay	Convection fan motor IP switched relay supplying VFD power

6.3 Removing / fitting the casing

Tools required

M5.5 hex socket wrench

Requirements

Check that the following requirements have been met:

- The appliance has been disconnected from the power supply and protective measures have been taken to ensure the power cannot be switched on again.
- The appliance is cool.

Removing the panels of the casing

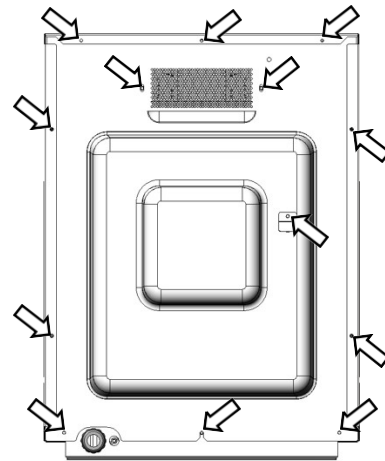
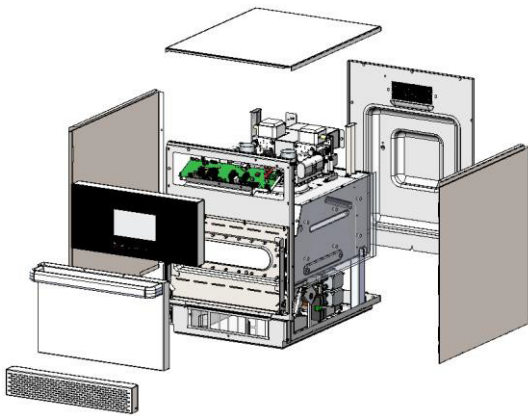

Overview of all M5.5 hex head flange bolts securing the panels of the casing.



1. Remove top panel first.

Unfasten the M5.5 hex head flange bolts at the back panel of the appliance attaching the top panel to the back panel.

X12 = two bolts

X16 = three bolts

Lift the top panel at the rear and pull out from the front fixing to remove it.



2. Removing the side panels:

Unfasten the six M5.5 hex head flange bolts (three per side) at the back panel of the appliance attaching each side panel to the back panel.

Slide the panels towards the back of the appliance and out at the bottom to remove them.



3. Removing the back panel:

Unfasten the six M5.5 hex head flange bolts attaching the back panel to the cooling duct (two bolts), the exhaust pipe & cover box (one bolt) and the baseplate (three bolts) of the appliance.

Move the back panel up to remove it.

Important: If the optional ethernet cable is fitted, disconnect before removing the back panel.

4. Ensure the high voltage capacitors are discharged before commencing any work.

■ Fitting the panels of the casing

Follow the steps in the reverse order to fit the panels of the casing, ensuring all 5.5M bolts are refitted and;

1. The side panels have been correctly slotted into the front cavity and base plate
2. The top panel has been correctly slotted into the front.
3. If fitted, ensure the ethernet lead is reconnected to socket
4. No wires have been trapped

Care must be taken when refitting the rear panel to ensure the cavity overheat thermostat re-set button lines up correctly with the access hole in the panel;



6.4 Removing / fitting the door assembly and hinges

■ Component



■ Tools required

- Two locking pins
- M5.5 hex socket wrench
- M8 hex socket wrench
- Torque wrench
- PZ1 Pozidriv screwdriver

■ Requirements

Check that the following requirements have been met:

- The appliance has been disconnected from the power supply and protective measures have been taken to ensure the power cannot be switched on again.
- The appliance is cool.
- Additional PPE, Mask & Gloves for handling insulation material.
- Remove the top and side panels.
- Ensure the high voltage capacitors are discharged before commencing any work.

■ Removing the door assembly

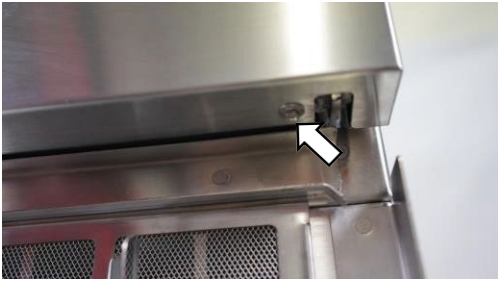

1. Remove the two M4 x10 hex Head Flange Bolts on the bottom of the door.

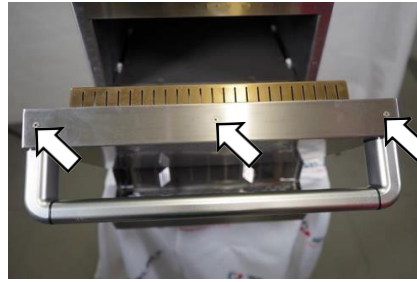

2. Remove the three M3 x12 CSK Philips Head screws along the top edge of the door.



3. Slide the door skin off the door.



4. Unfasten and remove the four M5 flange locking nuts & M5 hex head bolts from the door hinges



5. Open the door and fit the locking pins in place to prevent the hinges snapping back.

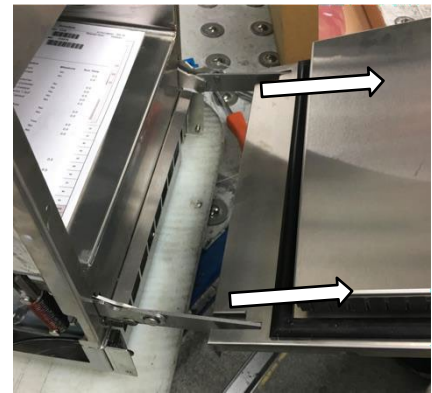

6. Slide door off the hinges to remove.

7. The door choke is removed by unfastening the sixteen M8 hex nuts. On refitting the door choke, ensure the studs are positioned correctly in the centre of the hole and not resting on the shoulder of the stud. The nuts should be retightened diagonally in the following sequence to 2.1 Nm.

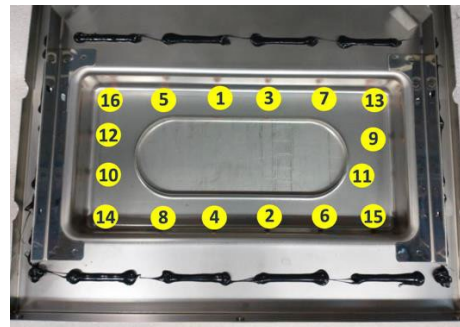
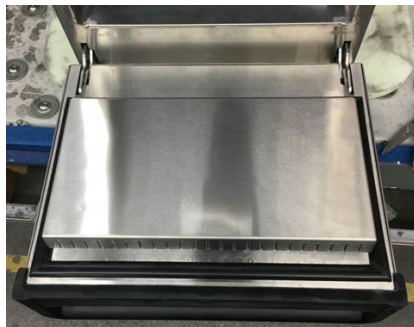

8. Wear gloves when removing or refitting insulation pads/mats in the door.

■ Refitting the door assembly

Follow the steps in the reverse order to refit the door to the oven.

- Holding the door squarely against the cavity, the hinge nuts and bolts should be torqued up to 3.5Nm.
- Apply Loctite to the door skin bolts and screws, which should then be torqued up to 1Nm.
- Check that the door seal firmly meets the cavity frame all the way around once closed. A poor sealing door can cause issues with the oven's operation.
- Check the door switches are correctly adjusted and operating freely.

■ Removing the door hinge assemblies

Firstly, follow the steps to remove the door from the oven as detailed previously.

1. Slacken the flange nuts and unscrew the interlock adjuster from the switch assembly bracket.
2. Unfasten and remove the four M4 x10 hex Head Flange Bolts (two each side) securing the switch assemblies from both hinges.
3. Ensure the locking pins are fitted to both door hinges.
4. Unfasten and remove the four M5 x 10 hex head bolts (two each side) securing the hinge assemblies to the cavity.
5. Slide the hinges out through the holes on the cavity front face.

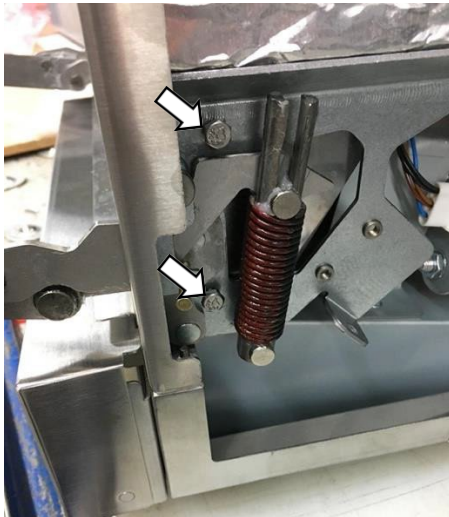
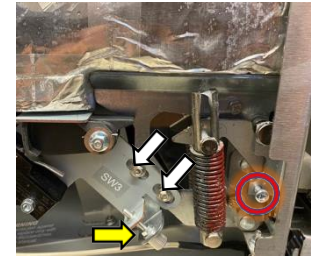
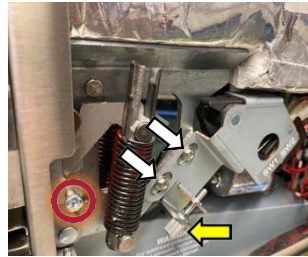

■ Refitting the door hinge assemblies

Follow the steps in the reverse order to refit the door hinge assemblies to the oven.

- The hinge assembly bolts should be torqued up to 3.5Nm.
- The switch assembly adjuster and fixing bolts should be torqued up to 2.1Nm.
- Refit the door as previously described.
- Set the door switch adjustment and ensure the operation is correct.

6.5 Adjusting the door microswitches/interlocks

■ Component

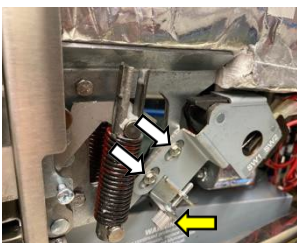

■ Requirements

Check that the following requirements have been met:

- The appliance has been disconnected from the power supply and protective measures have been taken to ensure the power cannot be switched on again.
- The appliance is cool.
- The top and side panels of the casing of the appliance have been removed.
- The high voltage capacitors are discharged before commencing work.

- Adjust the microswitches after refitting or replacing old with new door hinges.
- Adjust the microswitches after refitting the door or replacement of the door seal.
- Adjust the microswitches after refitting or replacing old with new door switches.
- Adjust the microswitches after determining incorrect operation during route service and maintenance.

■ Tools required

M5.5 hex socket wrench
 7mm open spanner
 Spacer kit
 Discharge Tool

■ Adjusting the door microswitches

Located on the door hinge brackets are 3 safety interlock microswitches, to prevent microwave emissions escaping when the oven door is opened:

- The primary microswitch (SW3), located on the left-hand side of the oven, breaks the electrical supply circuit to the HV transformers.
- The secondary microswitch (SW2), located on the right-hand side of the oven (outer), breaks the microwave circuit if the primary (SW3) fails.
- The monitor microswitch (SW1), located on the right-hand side of the oven (inner), will short out the microwave circuit blowing the F5 / F6 fuse, if the secondary microswitch (SW2) fails closed circuit.

IMPORTANT:

In the event that the monitor switch (SW1) causes the microwave circuit F6 / F7 fuse to blow, the secondary (SW2) and monitor (SW1) microswitches must be replaced due to exposure to high short-circuit currents.

The purpose of the following adjustment procedure is to set the interlock to switch off the microwave circuit when the door is opened more than 5 mm and for the microwave circuit to operate when the door is closed, and the door seal expands.

1. Open the appliance door and position the two white 3mm spacers over the top corners of the door seal. Then carefully close the door ensuring the spacers are still in position.



2. Loosen the interlock adjuster and locking nuts.
3. Loosen the two flange head screws just enough to let the microswitch bracket move.
4. Pull up the microswitch bracket until it sits against the underside of the insulation (as far as it will travel).
5. Screw the interlock adjuster to begin closing the switch actuator.
6. As soon as the primary door switch (SW3) closes, nip up the two flange head screws to 2.1Nm.
7. Tighten the interlock adjuster locking nut against the bracket using a 7mm spanner to 1Nm.

8. Remove the 3mm white spacers and replace with two blue 5mm spacers, again over the top corners of the door seal. Then carefully close the door ensuring the spacers are still in position.

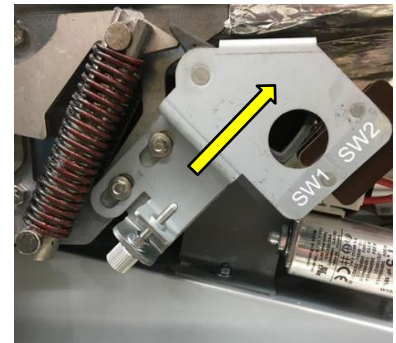
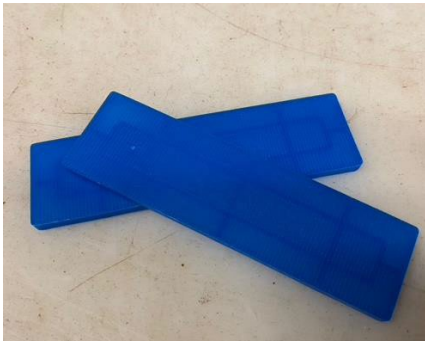

9. Loosen the interlock adjuster and locking nut.
10. Loosen the two flange head screws just enough to let the microswitch bracket move.
11. Pull up the microswitch bracket until it sits against the underside of the insulation (as far as it will travel).
12. Screw the interlock adjuster to begin closing the switch actuator.
13. As soon as the secondary door switch (SW2) closes, nip up the two flange head screws to 2.1Nm.
14. Tighten the interlock adjuster locking nut against the bracket using a 7mm spanner to 1Nm.
15. Remove the spacers, then open and close the appliance door a few times to validate the door switches operate in the correct sequence.
16. Once the panels have been refitted, conduct a microwave leakage test.

IMPORTANT:

Check if the switches operate in the following sequence as microswitch SW3 must switch the load current.

Oven door open

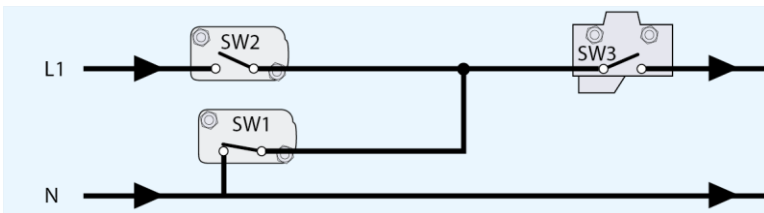

Closing the door:

- SW1 opens first
- SW2 closes second
- SW3 closes third

Oven door closed

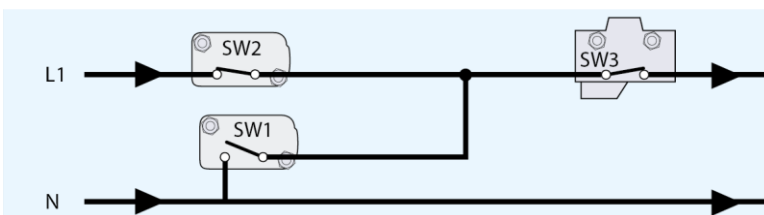

Opening the door:

- SW3 opens first
- SW2 opens second
- SW1 closes third

Right-Hand Side

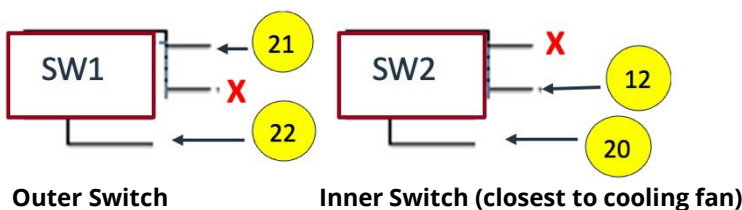

Left-Hand side

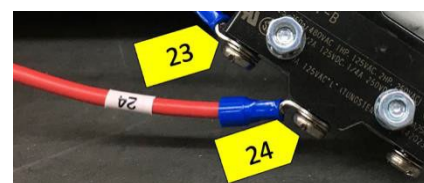

6.6 Replacing the door gasket

Tools required

Suitable gloves
Stanley / retractable knife
High temperature sealant
Cloth for wiping residue

Requirements

Check that the following requirements have been met:

- The appliance has been disconnected from the power supply and protective measures have been taken to ensure the power cannot be switched on again.
- The appliance is cool.

1. Place a Stanley / retractable knife blade underneath the door seal and go all the way to break the seal.

Ensure you do all four sides avoiding the metal clips on each corner.

Please ensure all safety aspects are adhered to while working with a sharp knife

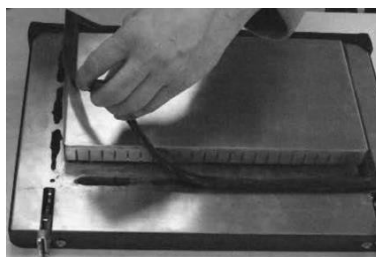

2. Gently pull the metal clip out of each corner and lift off the door seal.

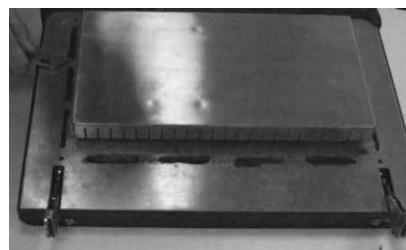

3. Remove remaining residue sealant using the knife or similar to make the surface is as flat and clean as possible.



4. Apply a continuous thin bead of Merrychef approved high temperature sealant around the existing door seal area. Ensure you do all four sides.

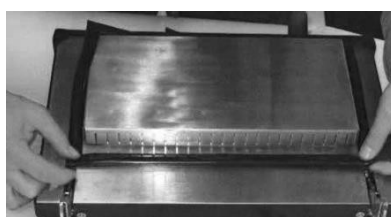

5. Place the new door seal over the door in the same place as the old one and insert the metal clips in each corner.



6. Press down firmly to tightly secure the door seal onto the door. Ensure it is level and square. Wipe off any excess sealant protruding for the door seal.

7. Leave to dry naturally. It will need 24 hours to dry but the heat of the oven can also be used to dry the sealant, speeding up the process.



8. Close the door, then open and close again to check the operation and ensure the seal does not move. Leave the door closed and let the sealant cure.

Note: The door seal can be replaced without removing the door skin

Heating up the oven to dry the seal

1. Switch the oven on and let it heat up to 250°C (482°F)
2. Keep the door shut for two hours.

The oven will be ready for usage again after 2 hours

Note: This is a generic procedure for the complete range of Merrychef combination ovens.

⚠ WARNING

Never use the oven without the door seal attached properly.

6.7 Replacing a magnetron

Component

The magnetron(s) is/are located on top of the cavity and is/are fixed to the waveguide(s), which in turn are fixed to the top of the cavity.

The standard power conneX variants comprise of a single magnetron & waveguide located on the top centre of the cavity. The high power conneX variants comprise of two magnetrons & waveguides, located on the top left of centre and top right of centre on the cavity.

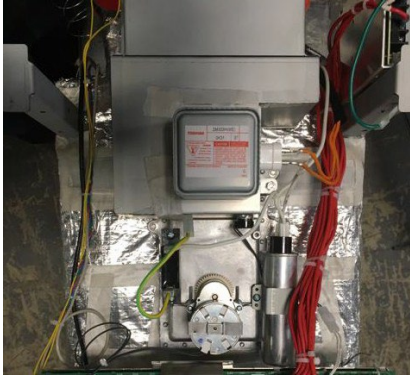

Air from the cooling fan is forced across the cooling fins of the magnetron(s) and into the cooling duct, which then vents the warmed air out of the back of the oven.

Tools required

Hammer or similar tool
PZ2 Pozidriv screwdriver
M8 hex socket wrench
Torque wrench
Discharge Tool

Requirements

Check that the following requirements have been met:

- The appliance has been disconnected from the power supply and protective measures have been taken to ensure the power cannot be switched on again.
- The appliance is cool.
- The top, rear, left and right panels of the casing of the appliance have been removed.
- The high voltage capacitors are discharged before commencing work.

Preparing a replacement magnetron

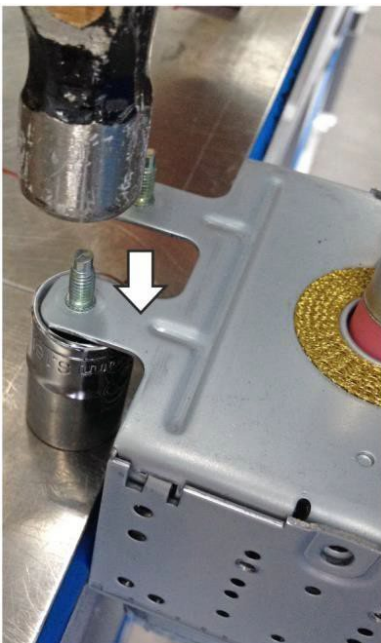

1. The new magnetrons come with four pressed studs for fixing. These studs need to be removed before fitting the magnetron to the oven.

NOTE:

The studs can be removed by knocking them out of the tabs with a hammer.

Ensure the tabs are not bent during this process. Secure them by laying them upon a piece of tube while pushing out the studs.



CAUTION

Wear personal protective equipment to protect your fingers when using the hammer.

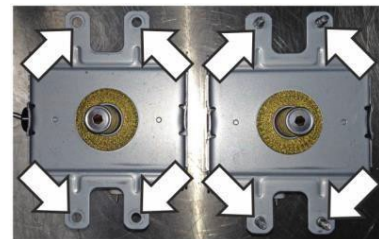

2. Comparison of spare magnetrons with (right) and without (left) pressed studs.

■ Removing a magnetron

1. Carefully peel back the sealing tape on the cooling duct (keep for reuse).
2. Unfasten the two M3 x 4 CSK Philips SS Screws and flat washers to disconnect the Cavity Overheat Thermostat from the cooling duct.
3. Unplug the magnetron high temperature thermostat(s) and earth lead(s).
4. Unclip the wiring loom from the cooling duct (High power conneX).
5. Standard power conneX - Unfasten the two Pozidriv screws on the inside of the cooling duct with a long PZ2 Pozidriv screwdriver from the rear of the oven).
6. High power conneX - Unfasten the two Pozidrive screws on each magnetron (four in total) on the outside of the cooling duct.

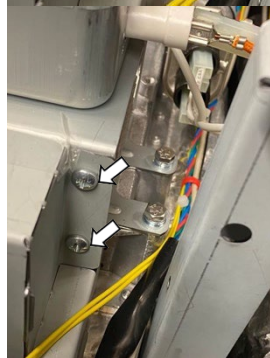
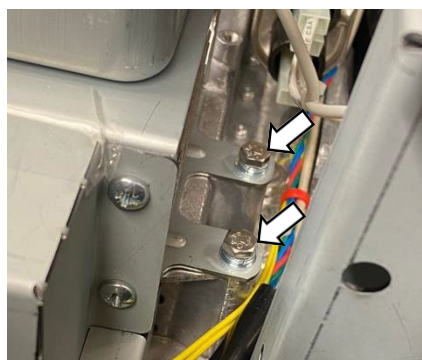

7. Disconnect the wiring from the magnetron(s).
8. Unfasten the four M8 hex cap bolts to remove the magnetron(s). There is one pair of bolts on each side of the magnetron(s).
9. Lift the magnetron out of the waveguide.
10. Remove the magnetron overheat thermostat(s) and earth tab, for refitment on to the replacement magnetron(s).

■ Fitting a magnetron

- Follow the steps in the reverse order to fit a replacement magnetron.
- Ensure the magnetron overheat thermostat is refitted in the same location to ensure correct operation.
- Ensure the RF (Radio Frequency) gasket is correctly seated.
- Fit all of the M8 bolts loosely, then tighten in a cross pattern to ensure the magnetron seats evenly. Torque to 2.1 Nm.
- Refit the cooling duct, ensuring the high temperature tape is reapplied on the top meeting faces between the duct and magnetron(s). Refit the cavity overheat thermostat, torquing the screws up to 1Nm.

⚠ WARNING

Ensure nothing becomes trapped under the magnetron mounting points (e. g. insulation material) while fitting the magnetron. This can lead to microwave leakage.

NOTICE:

If the electric connections have not been restored properly this may lead to malfunction/damage of the oven.

6.8 Replacing the cooling fan

Component

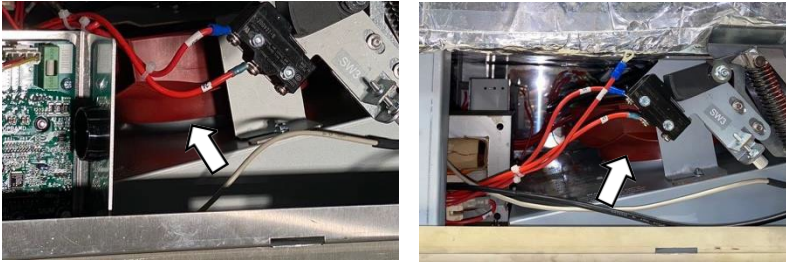

The cooling fan is located under cavity and can be accessed by;

X16 - moving the convection fan motor speed controller.

X12 - moving the door switch (SW3) bracket.

Tools required

M7 hex socket wrench
M5.5 hex socket wrench
7mm open spanner
Spacer kit
Discharge Tool

Requirements

Check that the following requirements have been met:

- The appliance has been disconnected from the power supply and protective measures have been taken to ensure the power cannot be switched on again.
- The appliance is cool.
- The top, left and right panels of the casing of the appliance have been removed.
- The high voltage capacitors are discharged before commencing work.
- Discharge cooling capacitor with discharge tool across the Molex connector.

Removing the cooling fan

X12 - remove the SW3 bracket from the left-hand door hinge assembly, as detailed in section 6.4 and swing out of the way. The wiring does not require disconnection.

X16 - remove the convection motor speed controller (VFD) assembly and swing out of the way. The wiring does not require disconnection.

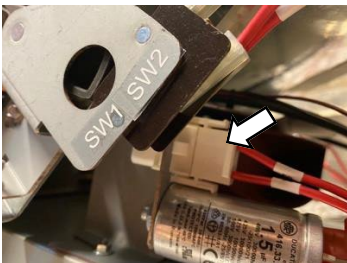

1. Unplug the electrical connection of the cooling fan on the right-hand side of the appliance.

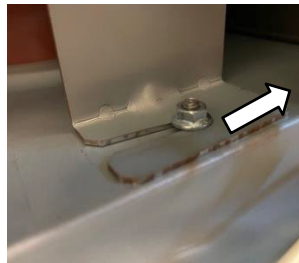

2. Loosen the two M7 hex nuts, each securing one arm of the sheet metal bracket which holds the cooling fan. Twist and remove the cooling fan via the left-hand side of the oven (when looking at the oven from the front).



Fitting the cooling fan

Follow the steps in the reverse order to fit the cooling fan, torquing the cooling fan bracket nuts to 2.1Nm.

NOTICE:

If the electric connections have not been restored properly this may lead to malfunction/damage of the oven.

6.9 Replacing the UI (User Interface) assembly

Component



The UI is attached to front panel of the oven, electrically connecting to the IO Board, Speaker and USB receptacle.

Tools required

M5.5 hex socket wrench / nut runner
Posidrive PZ1 screwdriver
Discharge tool

Removing the UI assembly

Requirements

Check that the following requirements have been met:

- The appliance has been disconnected from the power supply and protective measures have been taken to ensure the power cannot be switched on again.
- The appliance is cool.
- Anti-static precautions have been taken.
- The top, left and right panels of the casing of the appliance have been removed.
- The high voltage capacitors are discharged before commencing work.

1. Unfasten the single M5.5 hex head flange bolt fixing the front panel to the cavity frame. Looking from the front, top right above the IO Board.
2. Lift the front panel upwards and out to detach from the cavity frame.

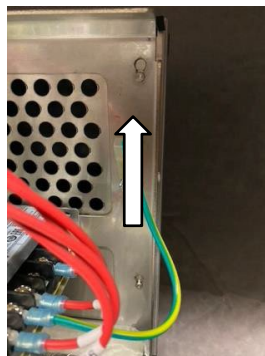
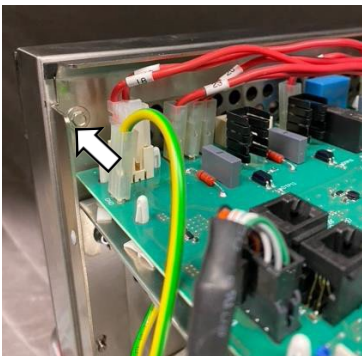

3. Disconnect the electrical connections; X523 on the IO board, the USB, ethernet and speaker loom connectors.



- Unfasten the three Posidrive screws at the bottom of the removed front panel and un-slot from the top of the panel to separate from the metalwork.

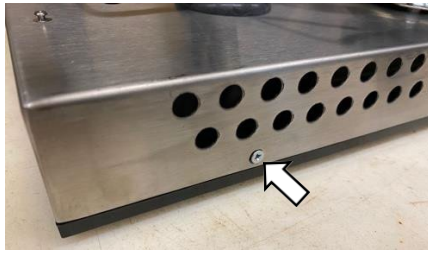

- Unfasten the eight posidrive screws from the UI clamp to separate the UI from the glass panel.



■ Fitting the UI assembly

Follow the steps in the reverse order to replace the UI assembly.

- Ensure the UI is square in the fascia panel and refit the clamp using the location pin as a guide.
- Do not overtighten the eight posidrive screws clamping the UI to the glass panel (0.7 Nm).
- Ensure the cables are not trapped when refitting the panel to the oven and reclip the loom to the underside of the IO board.



■ Replacing the UI assembly for new

- Ensure that the uSD card is removed from the old UI and fitted to the new assembly. Check that the dip switches are in the off (0) position. Accessed by prizing off the protective cap on the back of the UI assembly before fitting to the oven.

1 / 2 / 3 / 4 1 / 2 / 3
Off/Off/Off/Off - Off/Off/Off

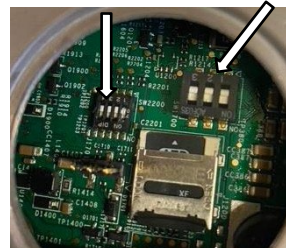

Micro SD Card replacement

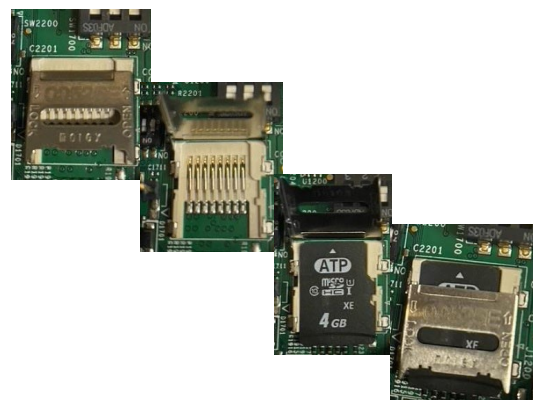

- Refit all oven panels, plug in the oven and switch on.

3. Run through the appliance setup to set / confirm;
 - a. language
 - b. date & time
 - c. Connectivity (WIFI / Ethernet / KitchenConnect)



4. Check the IO and UI versions are the latest release. If not, execute a firmware update using the latest versions. See section 4.5 for details.
5. Re-commission the under in the Service Settings

6.10 Replacing the IO Board (Input Output Board)

Component

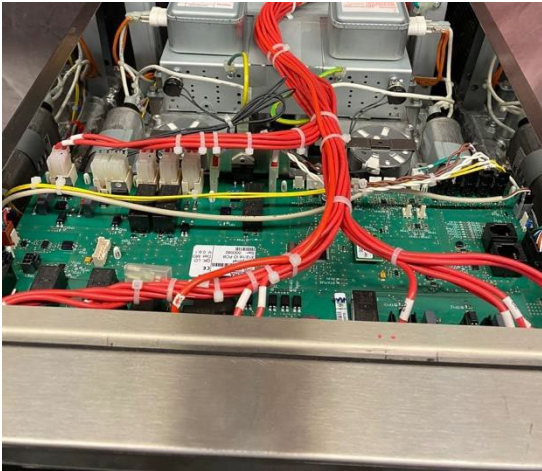

The IO Board extends over the width of the oven behind the front panel, above the cavity. It is mounted to the cavity frame.

The IO board supplies the control voltages to the UI and switches the oven components as required.

Unused connections may require link connectors fitted, ensure positions are noted before removal of the board from the oven.

Tools required

- M7 hex socket wrench / spanner
- Discharge Tool

Requirements

Check that the following requirements have been met:

- The appliance has been disconnected from the power supply and protective measures have been taken to ensure the power cannot be switched on again.
- The appliance is cool.
- The side and top panels of the appliance have been removed.
- The high voltage capacitors are discharged before commencing work.
- Anti-static precautions have been taken.

Removing the IO Board

1. Disconnect all the cables connecting the IO board to other components.
2. Loosen the two M7 hex nuts under the IO board on either side to remove the assembly from the frame of the cavity.

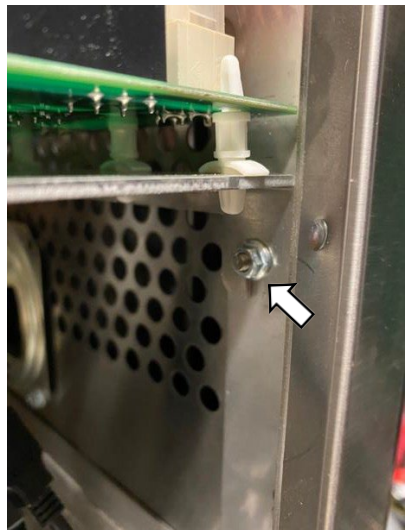
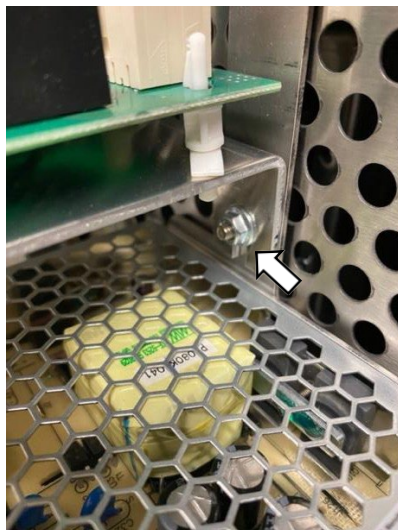
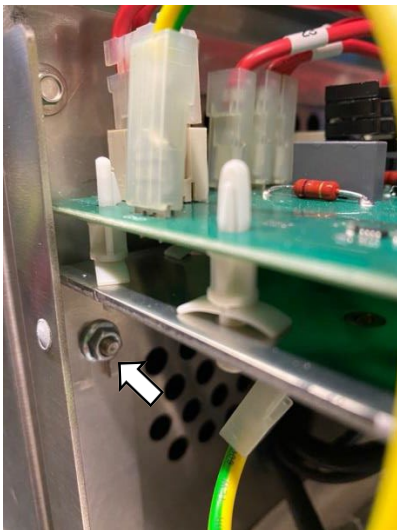

3. **NOTICE:** The IO Board should be placed safely aside the front of the oven to prevent IO.

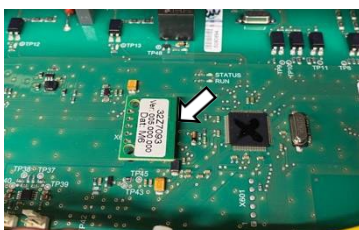

■ Fitting the IO Board

Follow the steps in the reverse order to fit the IO Board. For details see "IO Terminal Locations" in section 7.

Refit the Personality Module (PM) removed from the old IO Board to the new IO Board.

Reason: Replacement IO Boards come WITHOUT a Personality Module as the PMs store individual settings for the appliance.

Recommission the under in the Service Settings

NOTICE:

If the electric connections have not been restored properly this may lead to malfunction/damage of the oven.

6.11 PM (Personality Module) replacement

■ Fitting the IO Board Personality Module (PM)

■ Requirements

Check that the following requirements have been met:

- The appliance has been disconnected from the power supply and protective measures have been taken to ensure the power cannot be switched on again.
- The appliance is cool.
- The side and top panels of the casing of the appliance have been removed.
- The high voltage capacitors are discharged before commencing work.
- Anti-static precautions have been taken.

The personality module on the IO Board contains the IO Board dedicated firmware.

1. Unplug the old PM from IO Board and fit replacement PM (ensure part number is correct).
2. Refit all oven panels, plug in the oven and switch on.
3. Follow the screen prompts to update the IO firmware if requested.

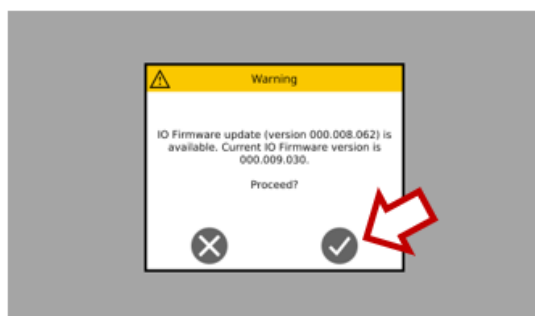

4. Check the IO and UI versions are the latest release. If not, execute a firmware update using the latest versions. See section 4.5 for details.
5. Recommision the oven in service settings.

6.12 Replacing the stirrer motor and stirrer assembly

Component



Requirements

Check that the following requirements have been met:

- The appliance has been disconnected from the power supply and protective measures have been taken to ensure the power cannot be switched on again.
- The appliance is cool.
- The top and side panels of the casing of the appliance have been removed.
- The high voltage capacitors are discharged before commencing work.

Tools required

M5.5 hex socket wrench

Pozidriv PZ1 screwdriver

M7 hex socket wrench

Torque wrench

Discharge Tool

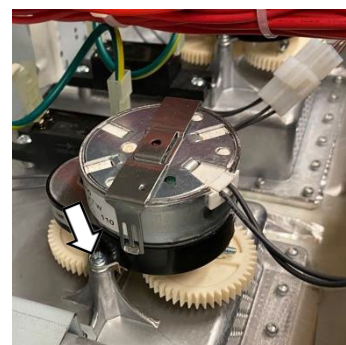

Removing the stirrer motor

1. Unplug the stirrer motor from the IO Board, connection X112.
2. Unfasten the two M3 x 8 Poszi screws holding the motor to the waveguide and lift out.

Removing the microwave stirrer

1. Unfasten the two M7 Hex screws at the front of the jet/impinger plate.
2. Drop down the jet/impinger plate slightly at the front and slide forward to release to two rear tabs.
3. The plate will then drop down and forward to remove.

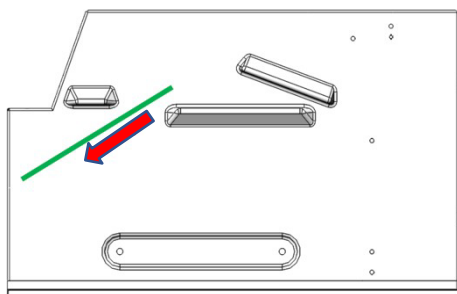

4. Unfasten the sixteen M7 hex nuts (nine on the standard power variants).

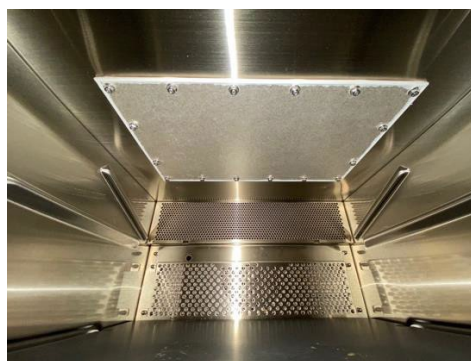
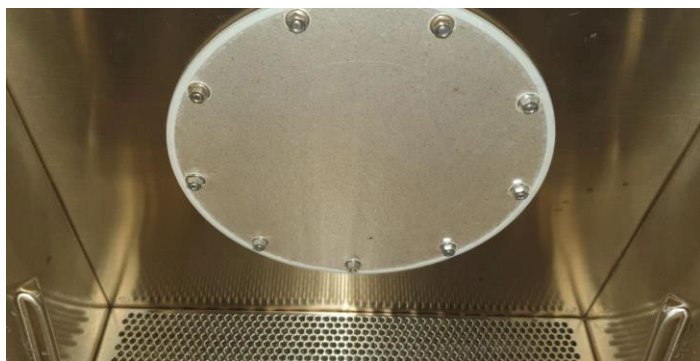

5. Carefully remove the partition plate.

NOTE: The partition plate features a rubber gasket on the side pointing upwards (to the stirrer) when mounted. The rubber gasket prevents grease laden air from soiling the stirrers and needs to be intact at any time.



6. The stirrer(s) is positioned inside the top of the oven cavity, above the partition plate.

7. To remove the stirrer from the spindle, turn anti-clockwise (looking up). Hold the stirrer cog located next to the motor cog to prevent the stirrer motor from rotating.

8. Remove any remains of the old gasket from the top of the cavity before fitting a new partition plate (comes with gasket) to ensure a good seal.



■ Fitting the stirrer motor and assembly

Follow the steps in the reverse order to fit the stirrer motor and stirrer.

⚠ IMPORTANT:

Follow the steps in the reverse order to fit the stirrer.

When refitting the partition plate fasten the screws on opposite corners/sides in turns and do NOT proceed stringently clockwise or anti-clockwise.

Tighten the partition plate screws to 2.1 Nm of torque.

Tighten the jet/impinger plate screws to NO more than 1.8 Nm of torque.

Tighten the stirrer motor pozidrive screws to 1Nm torque.

6.13 Replacing the convection fan motor

■ Component

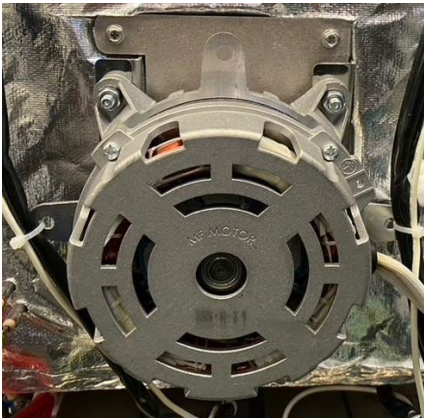

■ Requirements

Check that the following requirements have been met:

- The appliance has been disconnected from the power supply and protective measures have been taken to ensure the power cannot be switched on again.
- The appliance is cool.
- All panels of the casing of the appliance have been removed.
- The high voltage capacitors are discharged before commencing work.
- Additional PPE, Mask & Gloves for handling insulation material.

■ Tools required

- M7 hex socket wrench
- M7 hex spanner
- Torque wrench
- Heat tape
- Discharge Tool
- Stanley / retractable knife

■ Removing the convection fan motor

	<p>1. Remove the tape from around the rear edge of the cavity.</p>
	<p>2. Disconnect the convection fan wiring from the motor speed controller (VFD drive).</p>
	<p>3. Disconnect the two heater wires (see section 6.16).</p>
	<p>4. Locate the M7 hex nut and remove the steam vent pipe.</p>
	<p>5. Remove the cable ties fixing the wiring to either side of the fan motor and move the wiring clear of the back of the oven.</p>
	<p>6. Locate the ten nuts fixing the plate carrying the convection fan motor to the rear of the cavity. There are three nuts close to the horizontal edges and two nuts close to the vertical edges.</p> <p>Unfasten the ten M7 hex nuts to remove the plate with the convection fan motor assembly, being careful of the wiring in the vicinity.</p> <p>Note: Do not unfasten the four M13 bolts securing the convection fan motor to the plate.</p> <p>Removing the convection fan motor assembly will also give access to the upper & lower catalytic converters and the heating element.</p>

⚠ CAUTION:

Wear personal protective equipment to protect your fingers when using the knife.

■ Fitting the convection fan motor

Follow the steps in the reverse order to fit the convection fan motor assembly.

On replacement, ensure the rear plate is placed fully over the mounting points on the cavity before refitting and tightening the nuts, fitting new rubber gaskets if required, when refitting the replacement motor assembly and vent pipe, ensuring the mating surfaces are clean.

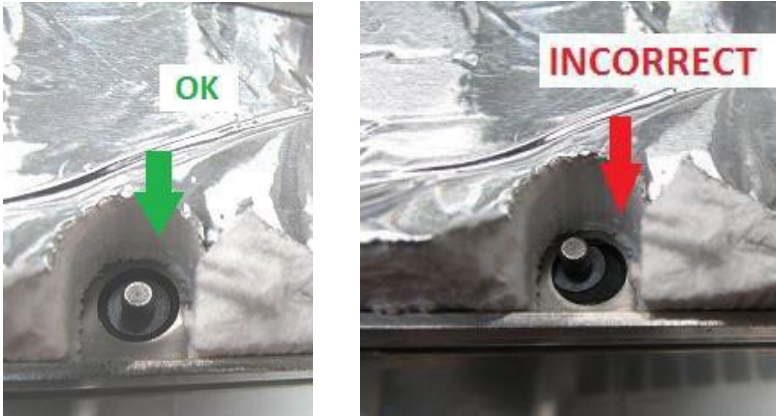

Ensure the flange nuts holding the convection motor in place have been torqued to 2.1Nm and are torqued diagonally and not clockwise.

6.14 Replacing a transformer (high voltage)

■ Component

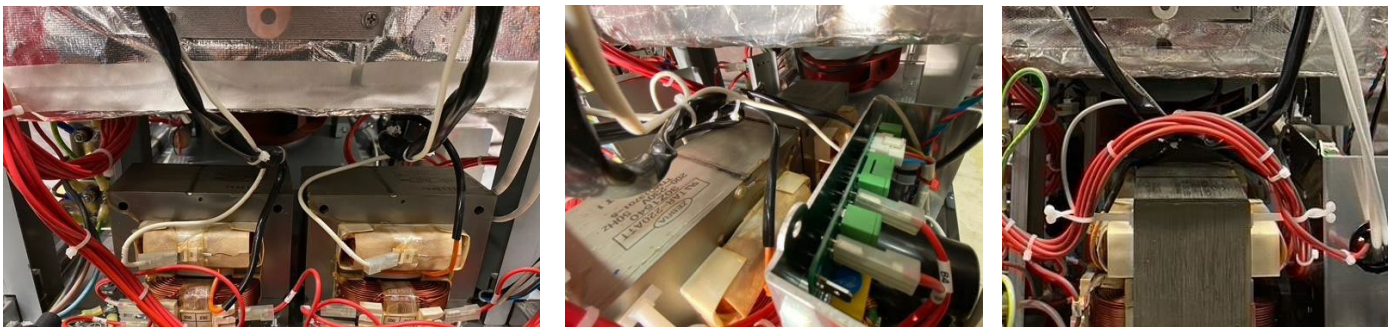

The X16 has two HV transformers, side by side, at the rear of the oven, under the cavity.

The right-hand transformer is for the right-hand microwave circuit & components.

The left-hand transformer is for the left-hand microwave circuit & components.

The X12 standard power variants have a single HV transformer at the rear of the oven, under the cavity.

The X12 high power variants have the rear HV transformer for the right-hand microwave circuit & components, with a second HV transformer further forward in the centre under the cavity, for the left-hand microwave circuit & components.

■ Tools required

M8 hex socket wrench

End cutters

Discharge Tool

⚠ CAUTION:

The transformers are heavy.

Wear safety shoes to protect your feet from a dropped transformer.

■ Requirements

Check that the following requirements have been met:

- The appliance has been disconnected from the power supply and protective measures have been taken to ensure the power cannot be switched on again.
- The appliance is cool.
- The casing of the appliance is removed.
- The high voltage capacitors are discharged before commencing work.

■ Removing a transformer (high voltage)

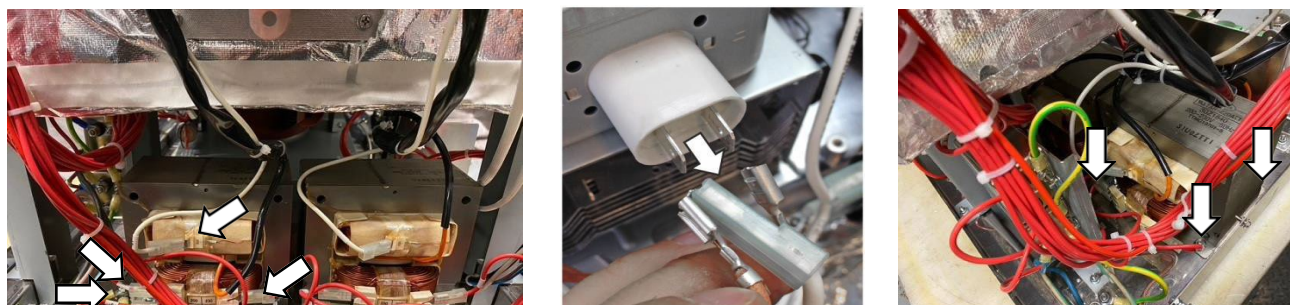

1. Unplug all the electrical connections on the transformer(s).
2. Disconnect the transformer(s) from the magnetron(s) by unplugging the orange filament cables at the magnetron(s).
3. Unfasten the four M5 flange nuts to remove a transformer.
4. On the X12 high power variants, the rear HV transformer should be removed first to gain access for removal of the front HV transformer.

■ Fitting a transformer (high voltage)

Follow the steps in the reverse order to fit the high voltage transformer(s).

- The fixing nuts should be torqued down to 3.5Nm.
- On the X12 high power variants, the HV transformer connections on the front HV transformer are on the left-hand side. The connections of the rear HV transformer are on the right-hand side (looking from the front).
- Ensure the wiring is fixed back in the original orientation with new cable ties.

NOTICE:

It is imperative that the electrical connections are replaced correctly. If the electric connections have not been restored properly this may lead to malfunction/damage of the oven.

Wire Number	X12 wiring connections				X16 wiring connections			
	Rear HV Transformer		Front HV Transformer*		RH HV Transformer		LH HV Transformer	
	50Hz	60Hz	50Hz	60Hz	50Hz	60Hz	50Hz	60HZ
31 →	0V	0V			0V	0V		
35 →	200V	208V			200V	208V		
36 →	230V	240V			230V	240V		
44 →			0V	0V			0V	0V
49 →			200V	208V			200V	208V
50 →			230V	240V			230V	240V

6.15 Removing the convection fan motor speed controller

Component



Requirements

Check that the following requirements have been met:

- The appliance has been disconnected from the power supply and protective measures have been taken to ensure the power cannot be switched on again.
- The appliance is cool.
- All casing of the appliance is removed.
- The high voltage capacitors are discharged before commencing work.
- Anti-static precautions have been taken.

Tools required

M7 hex socket wrench

Torque wrench

Removing/fitting the convection fan motor speed controller

1. Unfasten the two M7 hex head flange nuts.
2. Unplug all the electric cables.
3. Refit in reverse order, reconnecting the cables to the convection fan motor speed controller and fixing the bracket to the base plate, torqued to 2.1Nm.
4. Ensure the wiring of the speed controller is in accordance with the diagram shown.

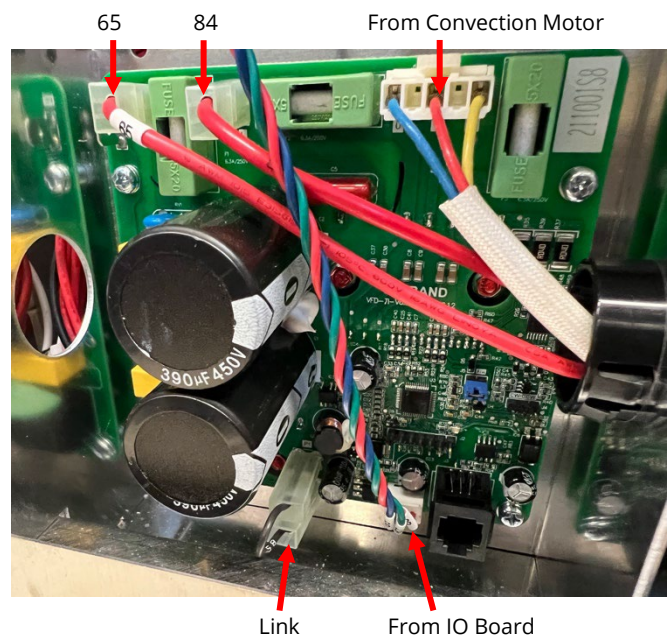
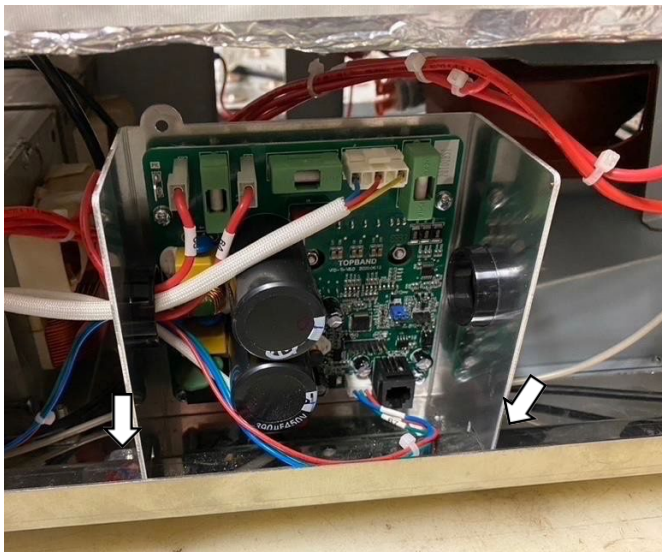

Note: Ensure the replacement board has a jumper (link) fitted to the J5 position.

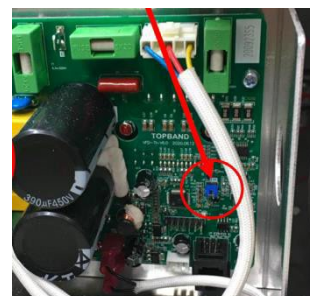

6.16 Replacing the heating element

Requirements

Check that the following requirements have been met:

- The appliance has been disconnected from the power supply and protective measures have been taken to ensure the power cannot be switched on again.
- The appliance is cool.
- The casing of the appliance is removed.
- The high voltage capacitors are discharged before commencing work.
- See section 6.13 for convection fan motor assembly removal to access the heating element

Additional Tools required

- 7mm open spanner

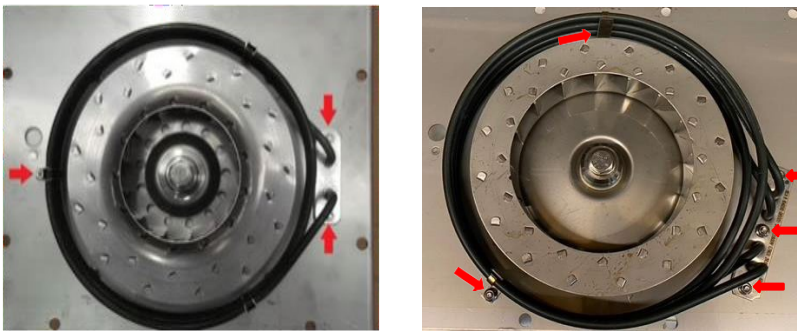

The element is fixed using two M7 hex bolts on the X12 & three on the X16, tightened to 2.1 Nm and supported with a single M5.5 hex flange nut on the X12 & two on the X16, tightened to 1.7 Nm.

Use a 7mm spanner to hold the terminal on the element and loosen the M7 hex nut fixing the wiring connection. Follow the same procedure re-connecting the wiring and tighten to 2 Nm.

X12

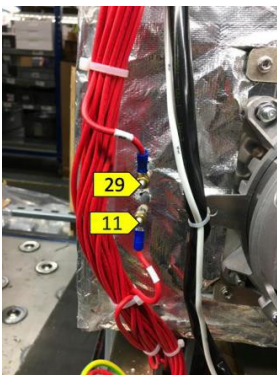

X16

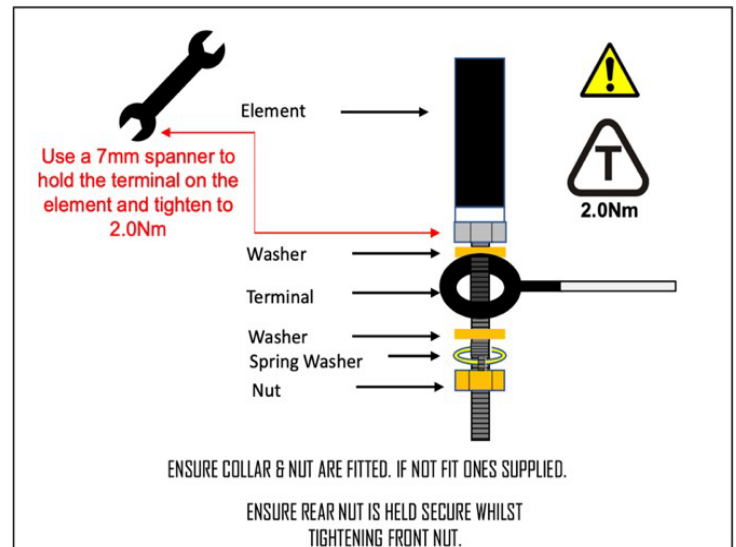
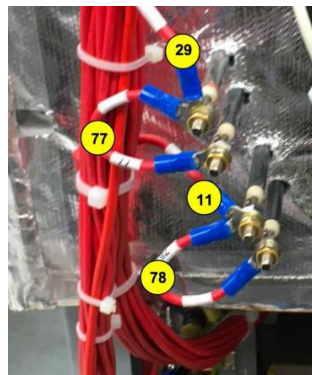

6.17 Overview – further components

Shelf (Cook Plate) Cavity Studs

There are four, conduction free, PTFE studs fitting in the cavity to support the cook plate, each held in place by M10 flange nuts and graphite stud gasket torqued to 0.6Nm. The nuts are locked with a screw.



Removable diffuser in the cavity

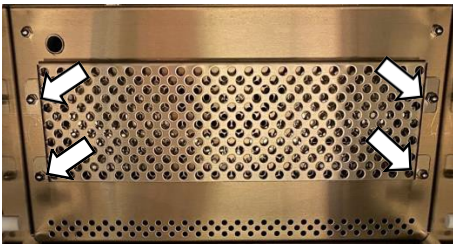

The rear air diffuser plate in the cavity prevents large foodstuff from hitting the rear of the cavity.

Loosen the bottom two M7 hex nuts and unfasten the top two M7 hex nuts to remove/refit.

Protective earth – connections to casing



M8 nut

Equipotential bonding connection



M8 nut (not fitted to some country specific versions)

■ Electromagnetic Compatibility (EMC) Filters

Top filter ~ Heater & Control Circuits.
Bottom filter ~ Microwave Circuit.

EMC filter to bracket by two M7 hex nuts.

EMC filter bracket to base plate by two M7 hex nuts, slotted in at the back.

Wiring connections by M7 hex head nuts, torqued to 1.2Nm;

1ph ovens, supply connected to the bottom filter. Live on the top terminal, neutral on the bottom terminal, both linked up to the top filter.

2ph ovens, L1 & N connected to bottom filter, live on the top terminal, neutral on the bottom terminal. L2 connected to the top filter (top terminal) and neutral linked from bottom filter.

US ovens, supply connected to the bottom filter. L1 on the top terminal, L2 on the bottom terminal, both linked up to the top filter.

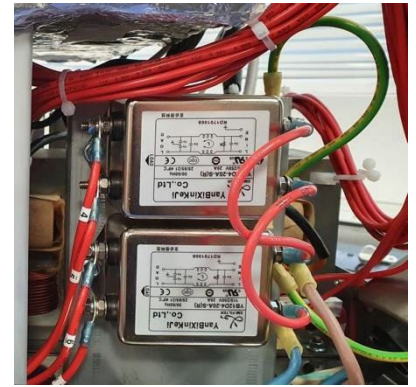

■ Diode(s) (high voltage)



One high voltage diode
(1000W e2s variant)

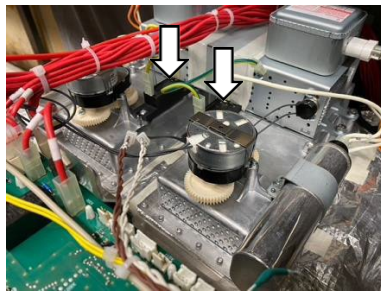

Two high voltage diodes
(2000W e2s variant)

Fitted by two pozidriv (PZ2) screws
to 1Nm.

■ Steam Vent (Exhaust pipe)

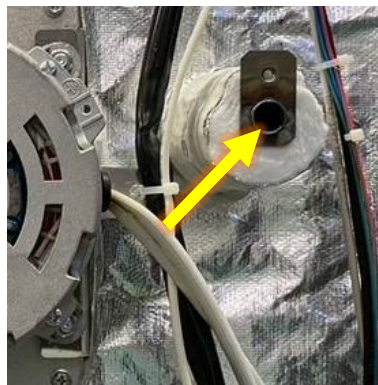

The straight steam vent runs from the rear of the cavity directly out of the rear of the oven, secured by a single M4 flange nut and gasket torqued to 2.1Nm. The steam vent is further supported by connection to the rear panel.



■ Cavity temperature sensor (thermocouple)



Cavity temperature measuring is done by a temperature sensor (thermocouple) connected to the IO Board.

The thermocouple is fitted in the rear of the cavity from the right-hand side, sealed with a gasket and held in place by a M7 hex nut.

■ Cavity Overheat Thermostat

The thermostat probe is located on the left-hand side of the cavity. The probe has a self-locating pressing within the bulb, slotting into the locating bracket held on to the cavity with a single M3 flange nut torqued to 1.2Nm. Ensure when fitting that the probe is equal length on both sides within the fixing bracket.

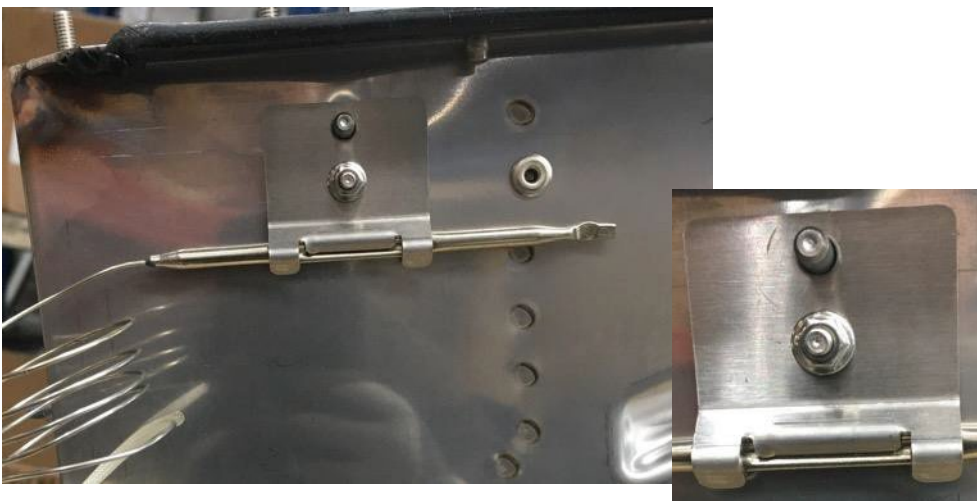

The cavity overheat thermostat switch is located at the rear of the oven, mounted on the left-hand side of the magnetron air flow ductwork, fitted by two M3 x 4 CSK Philips SS Screws and flat washers torqued to 1Nm.

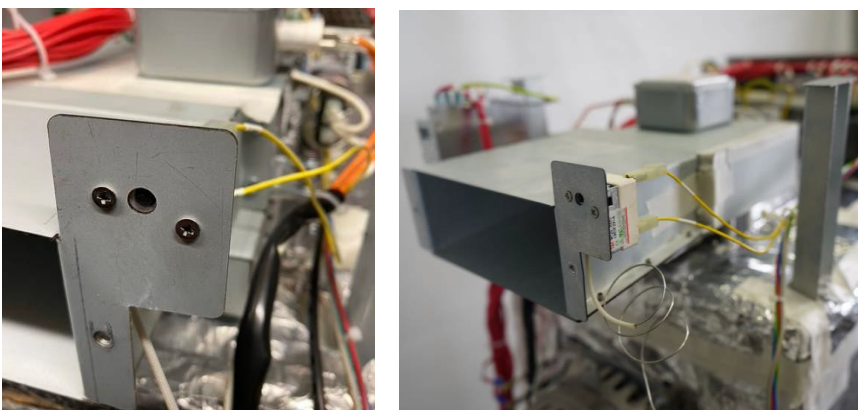

The manual reset button is now directly accessible from the rear of the oven.



Switch Mode Power Supply

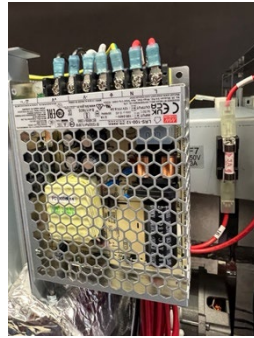
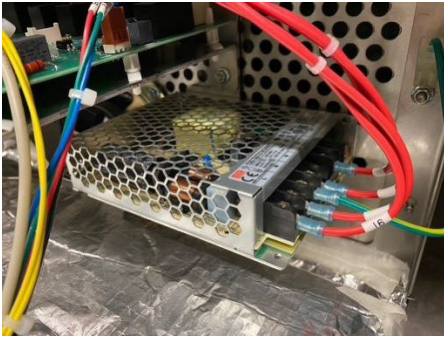

The Switch Mode Power Supply (ELV) is located;

- X12 – above the steam vent at the rear left-hand side, fitted by two M3 x 6 pozi screws, torqued to 1Nm.
- X16 – on the left-hand side of the IO board behind the front panel, fitted by two M3 x 6 pozi screws, torqued to 1Nm.

Providing the 12VDC supply to IO Board.

The 12VDC output voltage adjuster is factory pre-set and does not require adjustment. The green LED is illuminated to show correct functionality.

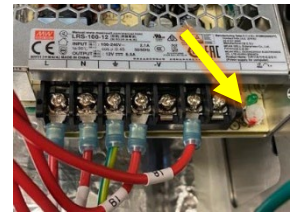

Capacitor(s) (high voltage)



The high voltage capacitor is located on top of the cavity and is fixed by a sheet metal bracket and a pozidriv (PZ2) screw

The high power, 2000W conneX variants comprises two high voltage capacitors, again located on the top of the cavity on each side, each attributed to a magnetron.

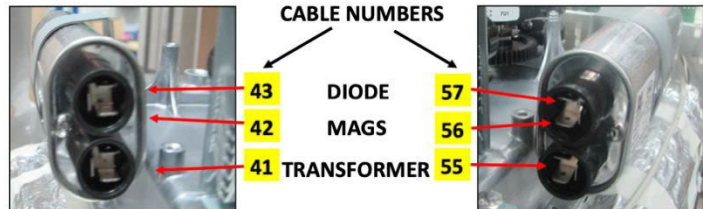

Centre / RH Magnetron

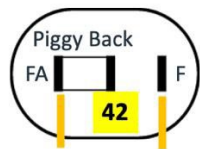
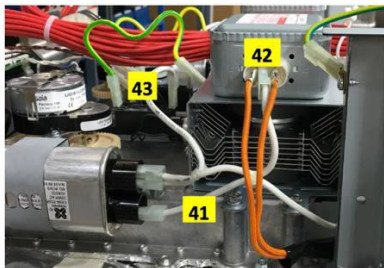

Insert HT wire 42 onto piggy back transformer wire

LH Magnetron (*high power variants only*)

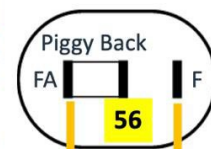
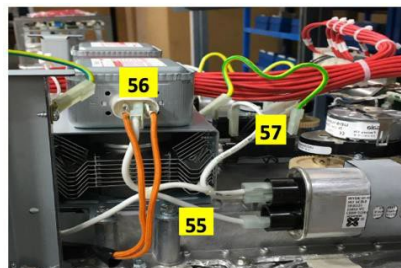

Insert HT wire 56 onto piggy back transformer wire

X12 – Centre / RH Magnetron is connected to the rear HV transformer. The LH Magnetron is connected to the front HV transformer.

X16 – RH Magnetron is connected the RH HV transformer. The LH Magnetron is connected to the LH HV transformer.

■ Mains Cable Entry

The mains cable enters the oven through a PG21 / PG16 cable gland on the base plate angled bracket at the rear righthand side of the oven.



■ Catalytic Converters



See section 6.13 for convection fan motor assembly removal to access the catalytic converters.

Once the fan motor assembly has been removed from the rear of the cavity, the four M7 hex nuts should be removed at the rear of the cavity (inside) to allow removal of the internal box and catalytic converters.

The upper catalyst is fitted using two M7 hex flange nuts, tightened to 2.1 Nm.

The lower catalyst, is again fitted using two M7 hex flange nuts, tightened to 2.1 Nm.

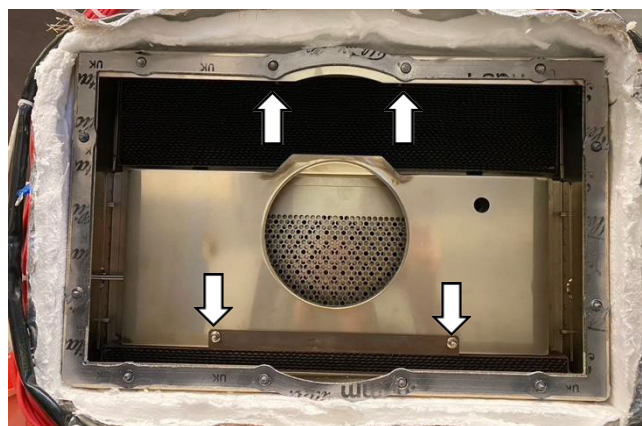

■ Air Filter Microswitch

The air filter microswitch is located on the bottom front left-hand side of the cavity frame by a M5.5 hex nut and wired directly to the IO Board (X511).



■ USB Socket

The USB socket is located on the bottom front left-hand side of the cavity frame by two M5.5 hex nuts and connected directly to the UI loom on the underside of the IO Board.

Note: a second, useable, USB socket is located under the IO board on the UI loom.

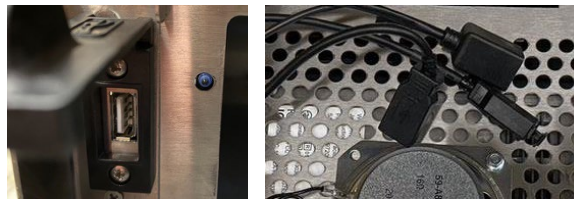

■ Speaker



The speaker is located on the rear of the front panel, behind the UI, by two M7 hex nuts and connected directly to the UI loom.



■ Air Filter Securing Magnet

The air filter is secured in position by two magnets on the cavity assembly.

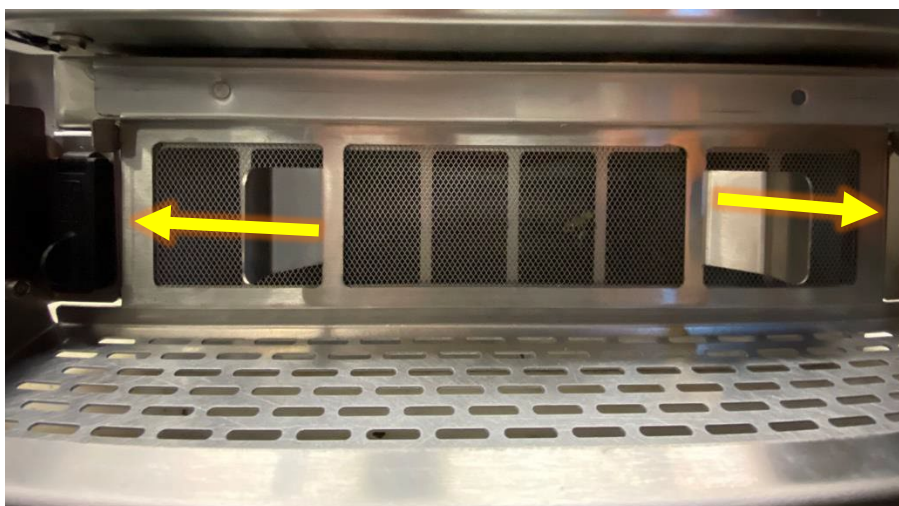

Fuses

The fuse assembly (F1, F2, F3, F4, F5 & F6) is located to the front of the mains filters on the right-hand side of the oven.

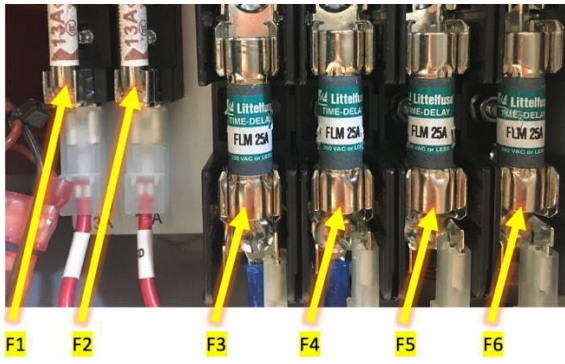

Note: Specific fuse rating and function can be found detailed in the circuit diagrams (Section 7.2)

F7 is located next to the SMPS

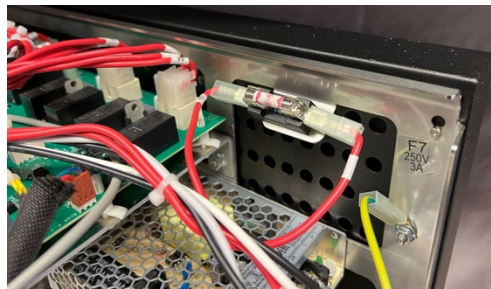

Convection Fan Safety Relay

The convection fan safety relay is located next to the VDF on the cavity stand.

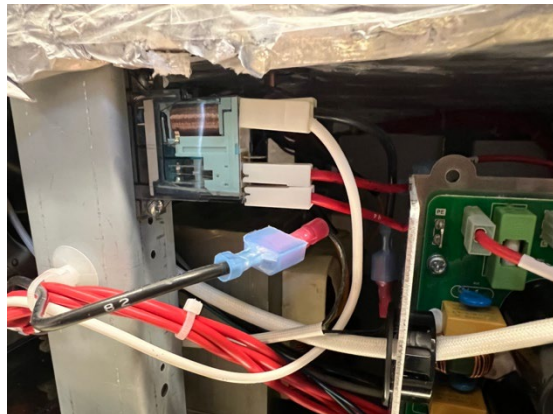
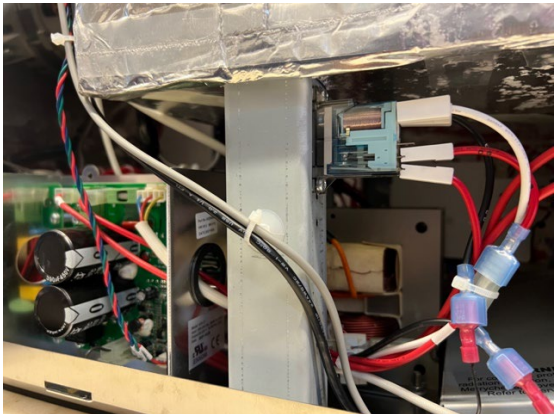

■ Rear Panel Fixings

Ethernet Port

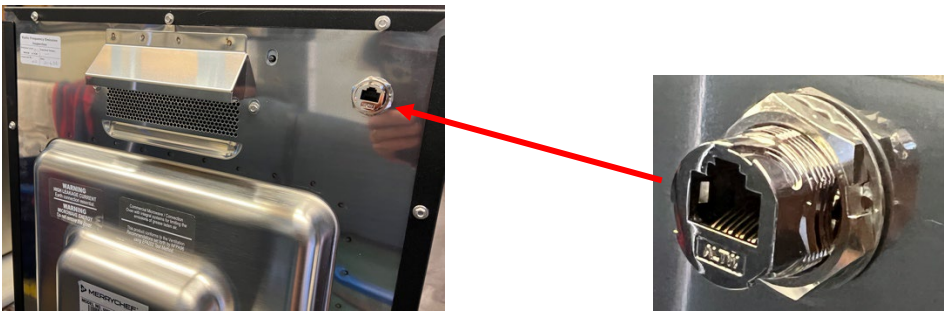

Hot air vent cover box



Auxiliary mounting studs (customer specific)

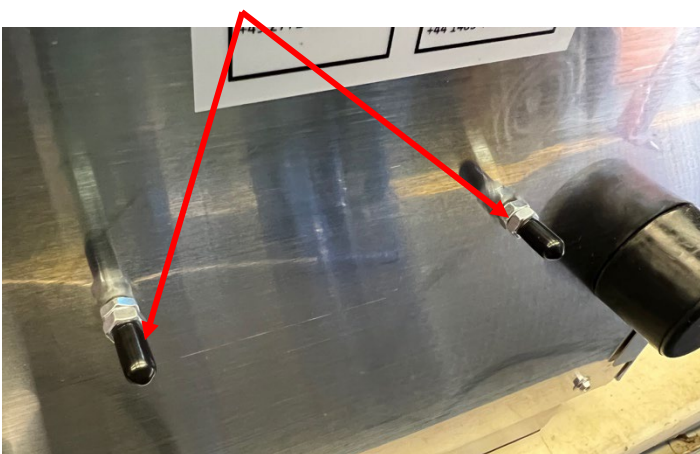

6.18 Technical Data Summary Sheet

Fuse Ratings	
F1 – F4	25A
F5 – F6	13A (*12A)
F7	3A
VFD Board	6.3A

Overheat Thermostat settings	
Cavity Stat	300°C
Mag Stat	125°C
Fan IP	160°C

Current Draws @ 230VAC	
Magnetron	7 – 8A

Circuit Breaker Ratings	
X12 SP	D16
X12 & X16 HP 1ph	D32
X12 & X16 HP 2ph	D16

Component Resistances	
EMI Filter L - N	330kΩ
Cooling Fan	220Ω
Stirrer Motor	7-8Ω
Convection Fan	7.5Ω ±10%
X12 Heater Element	19Ω
X16 Heater Element	26Ω
Magnetron	<1Ω
HV Transformer Pri	0.6Ω*
HV Transformer Sec	57Ω*
Capacitor	10MΩ
Relay Coil	295Ω

Maximum Cavity Temperature	
275°C	

Component Torque Settings (Nm)	
USB Assembly	2.1
Door Switches	1.0
Door Skin	2.1
Door Handle	2.1
Fuse Bracket	2.1
On/Off Switch PCB	1.0
Air Filter Assembly	1.0
Cavity to Base	2.1
Cooling Fan	2.1
Door Choke	2.3
Door Hinges	3.5
Mains Filter Bracket	2.1
Cavity Overheat Thermostat	0.7
Panels	2.1
Partition Plate	2.1
Stirrers	1.0
Impinger Plate	1.2
VFD Bracket	2.8
Waveguides	2.1
Heating Element Wiring	2.0
Mains Filter Wiring	1.2
Magnetron	2.1
Convection Fan Motor Assembly	2.1
Door Switch Bracket	2.8
UI to panel	0.8
IO Bracket	2.1
HV Transformer to Base	3.5
Voltage Selection Relay to Base	0.8
Speaker	2.1
Cavity Thermocouple	1.7
LV Transformer	2.1
Steam Vent Pipe	2.1
Front Panel	2.1
Mains Filter to Bracket	2.8
Fuse Holder	1.0
VFD to Bracket	2.8
Cook Plate Studs	8.0
Heating Element	2.1

Error Codes	
E81	Firmware updated
E82	Menu updated
E83	Incompatible IO version
E84	Date not set
E86	Oven switched on
E87	Touch screen held for 15 sec
E88	Supply voltage <180V
E89	Recommission test failure cooling fan
E90	Recommission test failure convection fan
E92	Recommission test failure heater(s)
E93	Recommission test failure magnetron(s)
E94	Recommission test failure air filter in
E95	Recommission test failure air filter out
E96	Recommission test failure door switches close
E97	Recommission test failure door switches open
E98	Incomplete cleaning cycle
E99	Filter override accepted
E100	Mains supply switched on
E101	Magnetron(s) failed on request.
E102	Heater on without request.
E103	Ambient Overheat. UI or IO >70°C
E104	Safety circuit open (Overheat Thermostats)
E105	Supply frequency out of range by ±2Hz
E106	Cavity 75°C above setpoint or 300°C
E107	Communication fault between UI & IO
E108	Missing or corrupt UI uSD
E109	Missing or corrupt IO PM
E110	Incompatible IO firmware
E111	Cavity sensor open circuit
E112	IO temperature sensor failure
E113	Magnetron(s) on without request. >1A
E116	Heater off on request.
E117	RH Mag Stat open circuit
E118	LH Mag Stat open circuit

* see section 3.1 'Technical data, checks and verification' for non-EU model specific readings where they differ.

7 Circuit boards and diagrams

7.1 IO circuit board

IO LEDs

- P-Bus – irregular flashing, indicating data communication with UI.
- Run – Pulsing 1 second flash, indicating that the board has booted up.
- 12V, 5V & 3.3V – lit to show voltages from SMPS and inboard transformer.
- Relay and triac – lit to show that a signal has been sent to energise that component.
- Door switches – lit to show door closed.
- Overheat thermostats – lit to show portion of closed safety circuit.

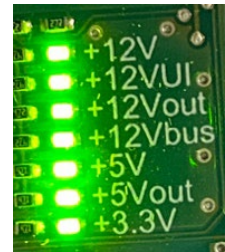

LED positions ~

LD14 – Safety circuit. Cavity heat thermostat closed = yellow

LD16 – Safety circuit. RH Mag overheat thermostat closed = yellow

LD18 – Safety circuit. LH Mag overheat thermostat closed = yellow

LD15 – Safety circuit. Not used, linked out = yellow

LD17 – Safety circuit. Not used, linked out = yellow

LD19 – Run. Yellow on/off IO board functioning

LD20 – Status. Rapid yellow flashing, P-Bus communication with UI

LD25 – Heater safety relay, yellow = closed / OK

LD1 – Heater drive, pulsing yellow (varying with wattage)

LD26 – not used, yellow

LD24 – Aux safety relay, yellow

LD29 – VDF supply, yellow

LD27 – Stirrer motor(s), yellow

LD28 – Cooling Fan, on / pulsing yellow (varying with wattage)

LD9 – 12V supply from SMPS, green = OK

LD11 – 12V supply to UI, green = OK

LD10 – 12V supply to Aux circuits green = OK

LD12 – 12V buss supply, green = OK

LD30 – 5V supply from onboard transformer, green = OK

LD31 – 5V supply from onboard transformer, green = OK

LD13 – 3.3V supply from onboard transformer, green = OK

LD7 – Not used, yellow

LD8 – Not used, yellow

LD23 – Not used, yellow

LD6 – Door switches, yellow = door closed

LD21 – Microwave safety relay, yellow = closed / OK

LD3 – RH Magnetron, yellow = on

LD5 – MW voltage selection relay, yellow = 200/208 VAC HV transformer tapping

LD4 – LH magnetron, yellow = on

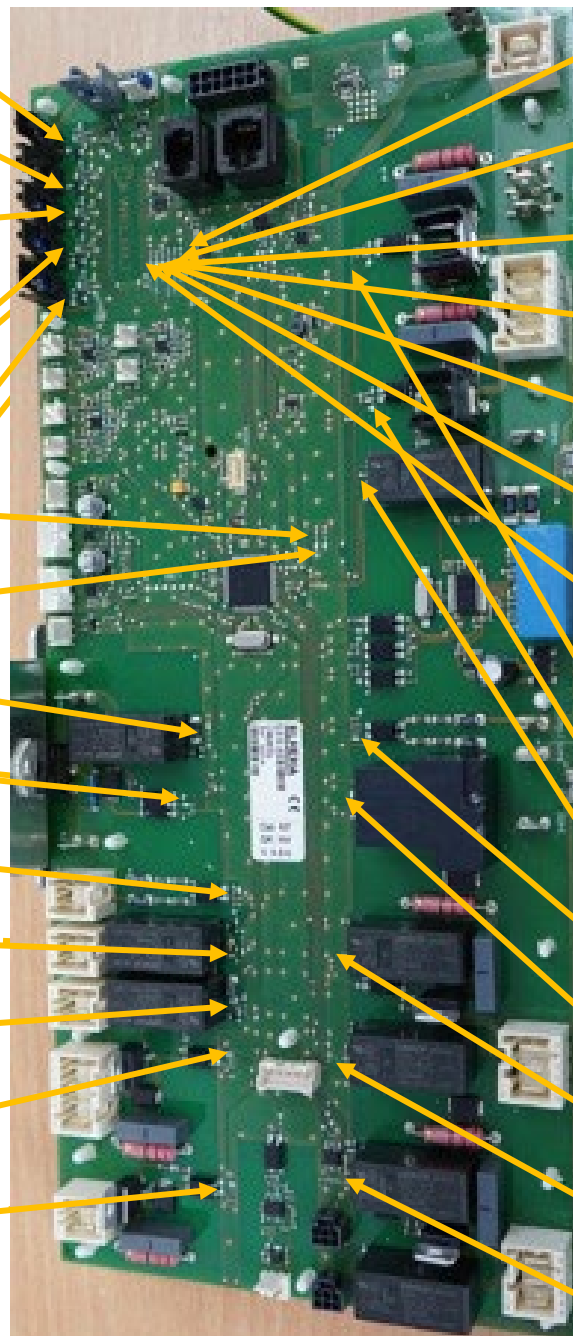

IO terminal locations

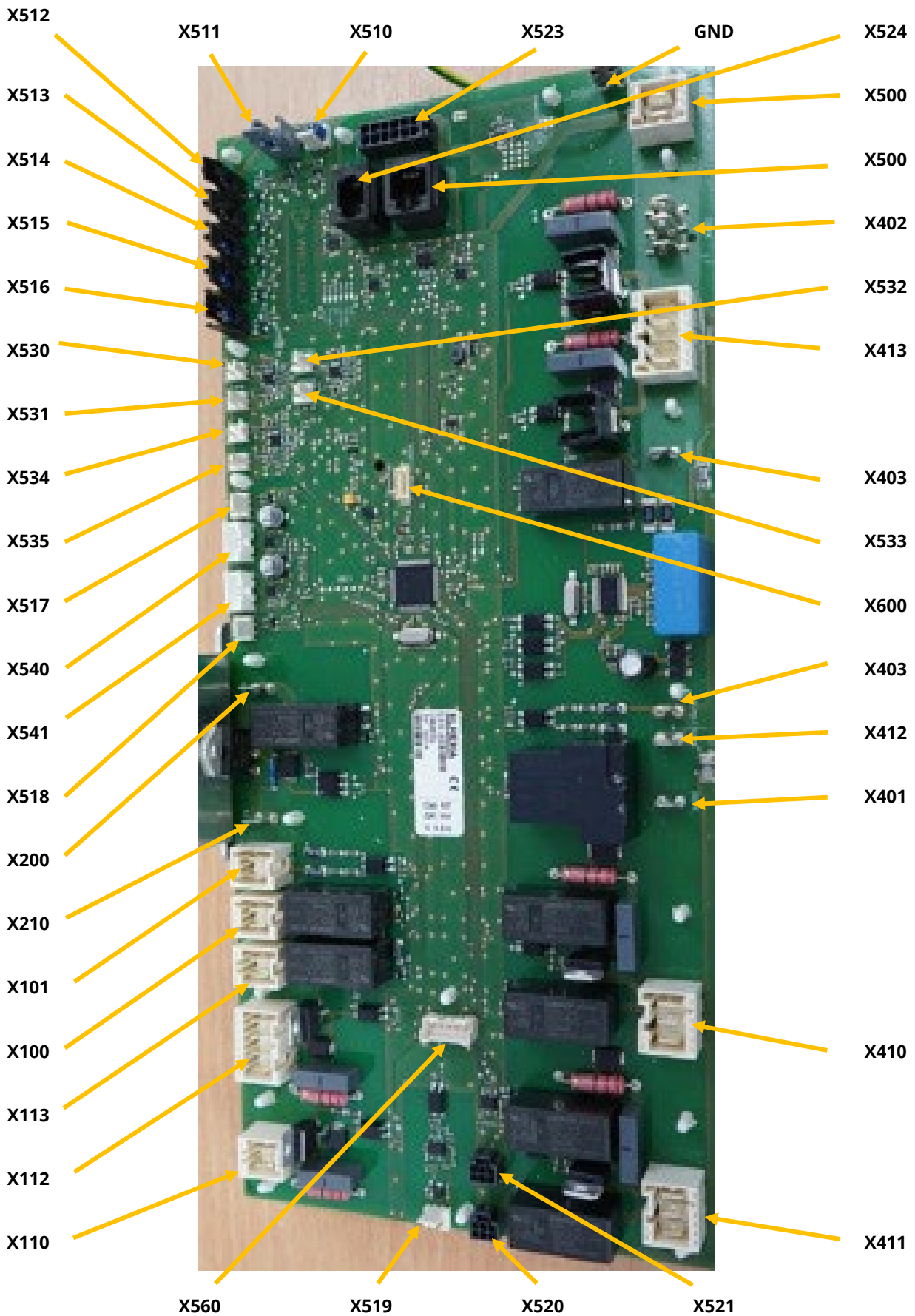

IO terminal legend

Terminal	Connection
X100	Wire 14 – Live from F1 Wire 15 – Neutral (US L2) from top mains filter
X101	Wire 16 – Live to Switch Mode Power Supply Wire 17 – Neutral (US L2) to SMPS
X110	Wires 58 & 59 – cooling fan supply
X112	Stirrer motor(s)
X113	Wire 64 – Live to Fan Safety Relay (wire 84 to VFD) Wire 65 – Neutral (US L2) to VFD
X200	Wire 10 – Live from F3
X210	Wire 29 – Live to heating element(s)
X400	Wire 24 – Live from door SW3 for microwave circuit(s)
X401	Wire 13 – Neutral (US L2) from F6
X402	Door Switch Interlock Wire 20 – Live from door SW2 Wire 22 – Neutral (US L2) from door SW1 Wire 23 – Live to door SW3
X403	Wire 26 – Live from F5
X410	RH / Rear HV Transformer Wire 31 – terminal 0. Neutral (US L2) Wire 35 – terminal 200/208. Live Wire 36 – terminal 230/240. Live
X411	LH / Front HV Transformer Wire 44 – terminal 0. Live Wire 49 – terminal 200/208. Neutral (US L2) Wire 50 – terminal 230/240. Neutral (US L2)
X412	Wire 21 – Neutral (US L2) to door SW1
X413	Not used
X500	12VDC supply from SMPS. Wire 18 + Wire 19 -
X510	Not used – Linked out (jumper)
X511	Air Filter micro switch
X512	Cavity overheat thermostat. Wires 70 & 69
X513	Centre / RH Magnetron overheat thermostat. Wires 72 & 71



Terminal	Name
X514	LH Magnetron overheat thermostat. Wires 74 & 73
X515	Not used – Linked out (jumper)
X516	Not used – Linked out (jumper)
X517	Not used
X518	Not used
X519	Convection fan speed controller (VFD) signal Wire 66 red, 0-10V Wire 67 green, 10V Wire 68 blue, GND
X520	Not used
X521	Not used
X522	Not used
X523	UI communication and power cable
X524	Not used
X530	Cavity temperature thermocouple
X531	Not used
X532	Not used
X533	Not used
X534	Not used
X535	Not used
X540	Not used
X541	Not used
X560	Not used
X600	PM
GND	Chassis ground

Note: IO Board test points (TP1 to TP58) are for factory build procedures only.

7.2 Circuit diagrams

conneX wiring diagram 50Hz 200/230V

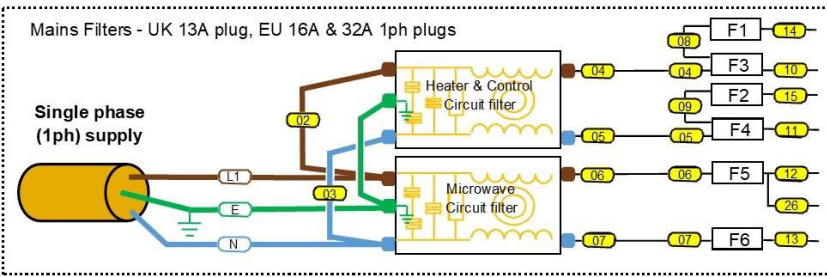

Fuse Ratings						
F1	F2	F3	F4	F5	F6	F7
13 Amp	13 Amp	25 Amp	25 Amp	25 Amp	25 Amp	3 Amp
(L1)	(Neutral)	(L1)	(Neutral)	(L1)	(Neutral)	(L1)

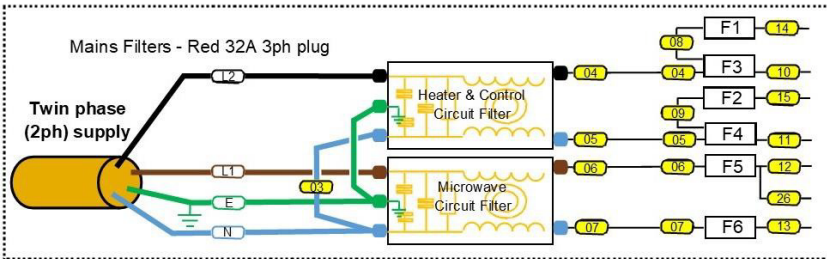

Fuse Ratings						
F1	F2	F3	F4	F5	F6	F7
13 Amp	13 Amp	25 Amp	25 Amp	25 Amp	25 Amp	3 Amp
(L2)	(Neutral)	(L2)	(Neutral)	(L1)	(Neutral)	(L2)

Door switches - LV safety interlock circuit

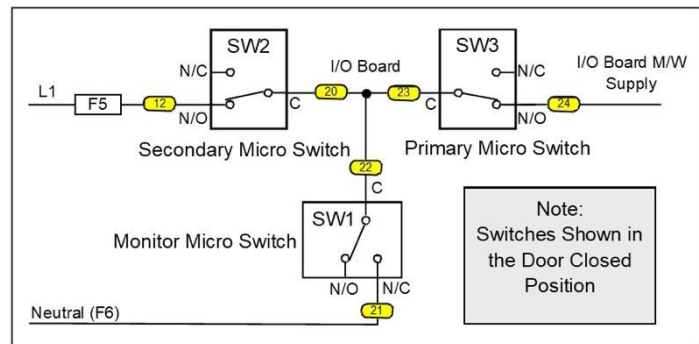
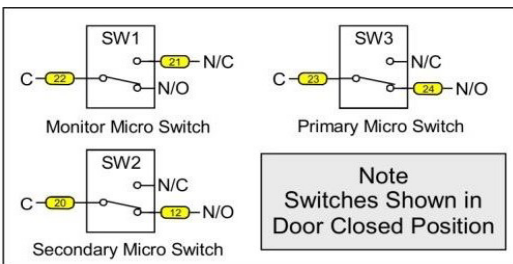

Overheat thermostats - ELV safety circuit

1000W Ovens

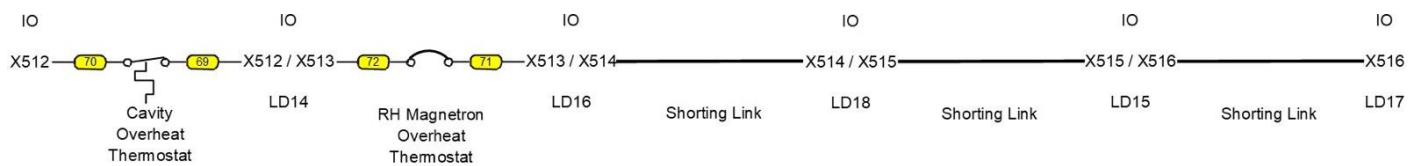

2000W Ovens

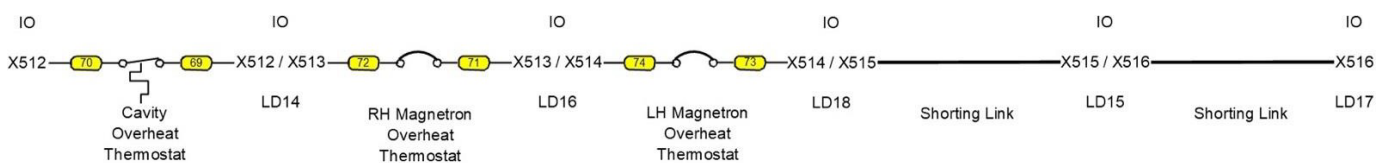

IO BOARD

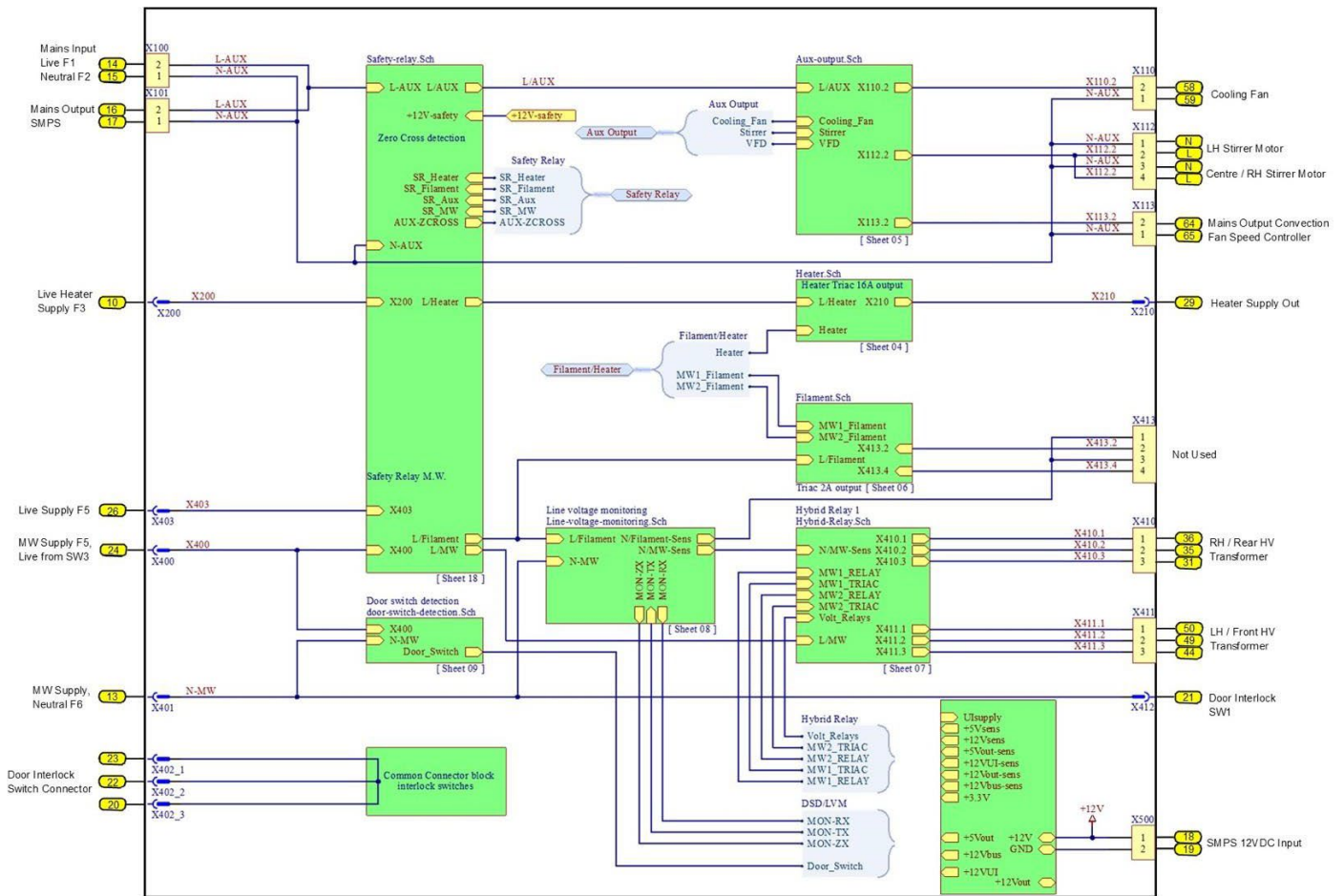

IO Board LV Connections

Notes: Standard power versions (Centre Magnetron only)

- X514. Link fitted
- X112. Pins 1 & 2 not used
- X411. Not used

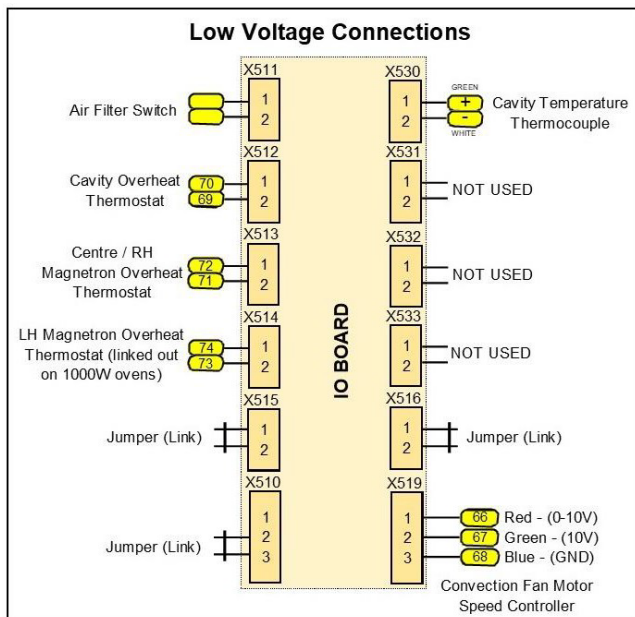

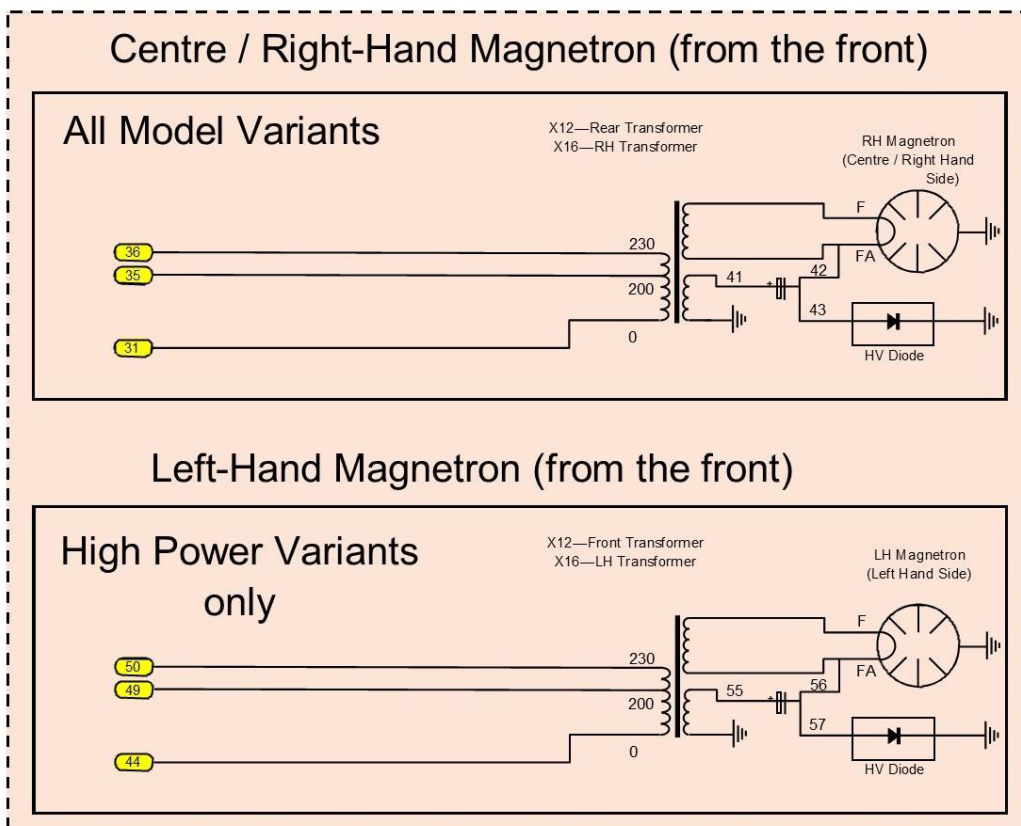
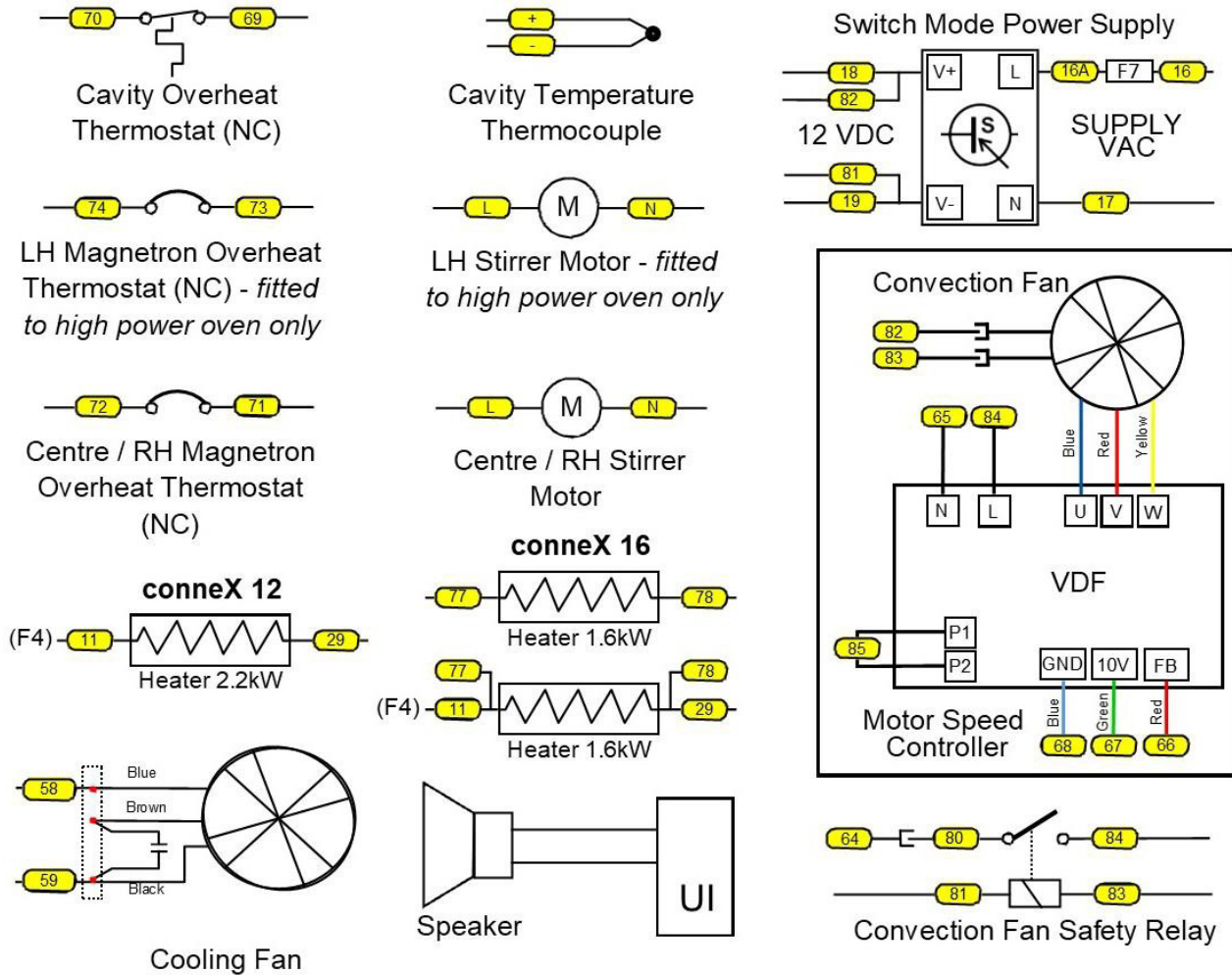

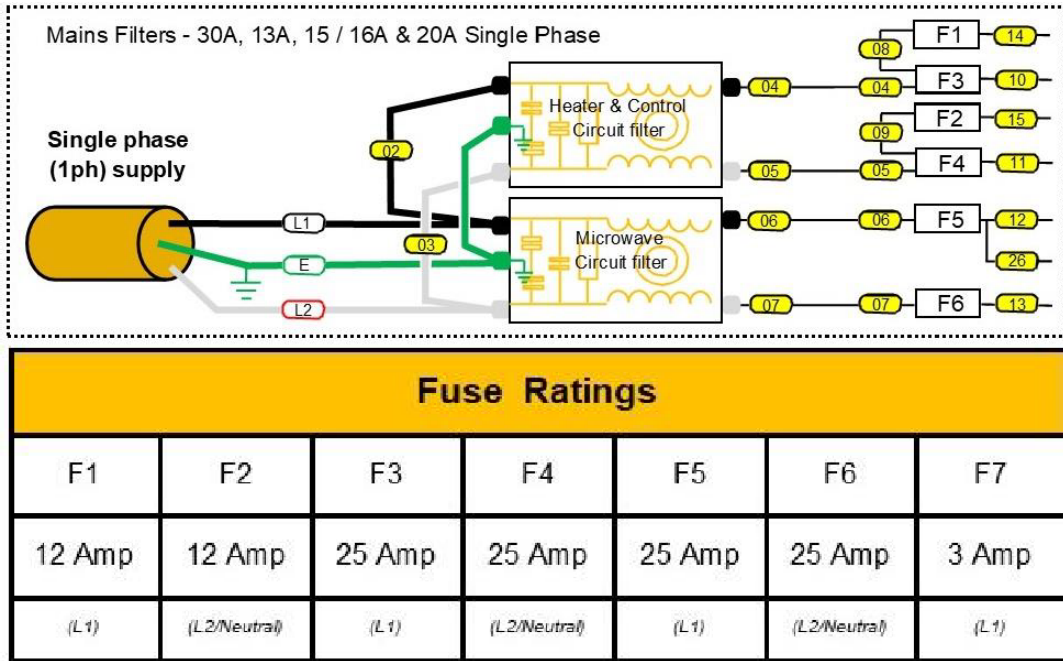

Door switches - LV safety interlock circuit

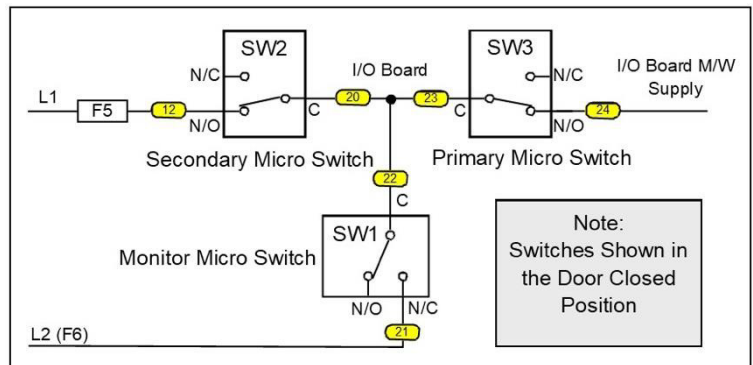
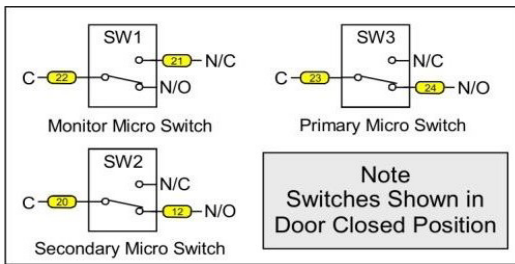

Overheat thermostats - ELV safety circuit

1000W Ovens

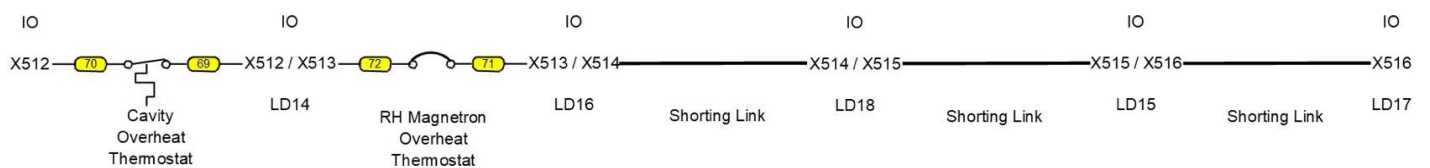

2000W Ovens

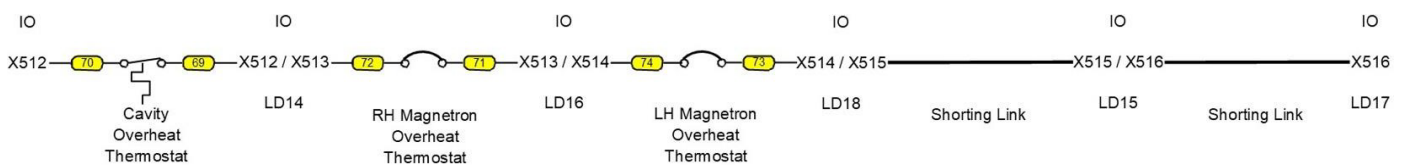

IO BOARD

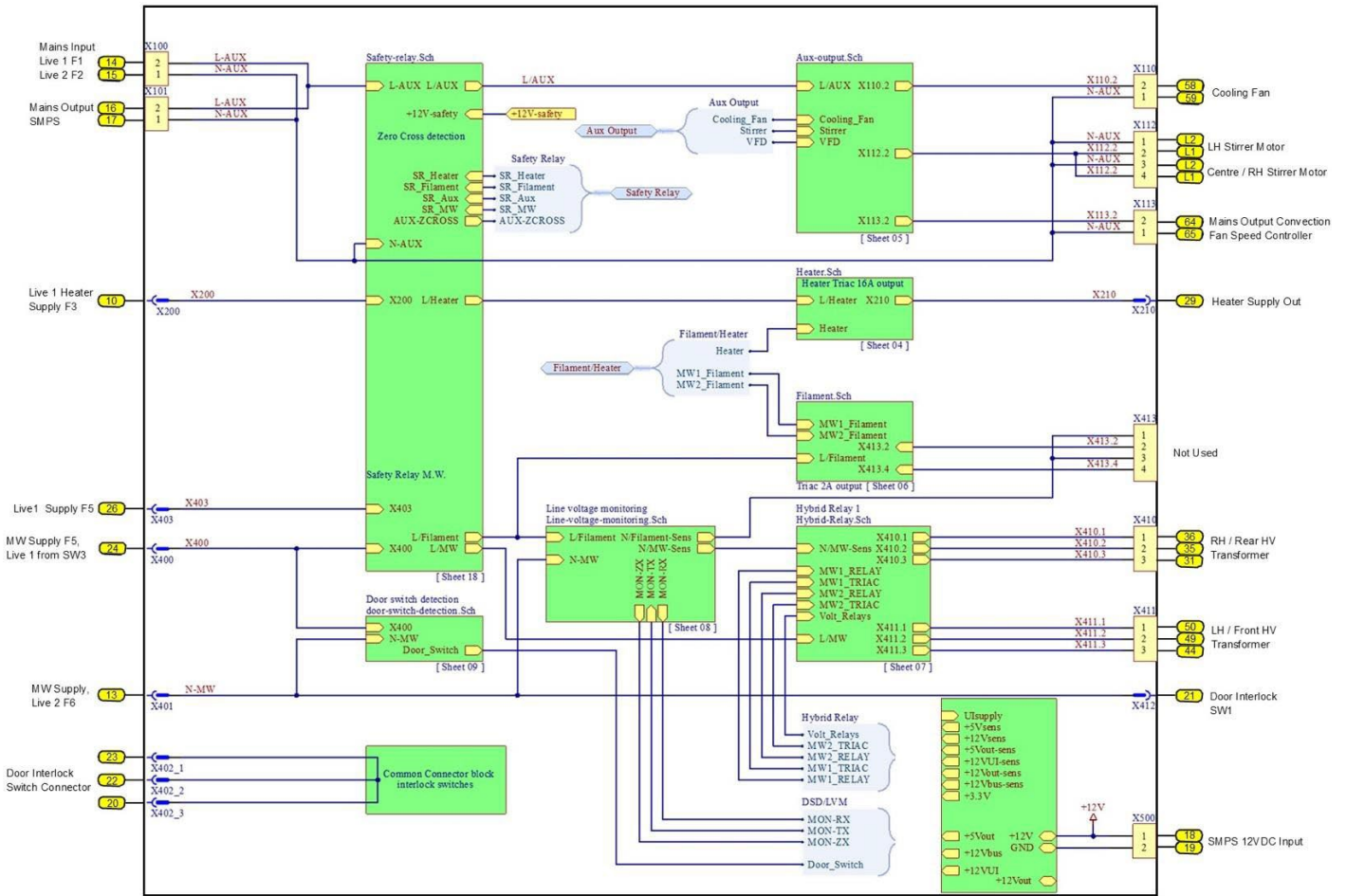

IO Board LV Connections

Notes: Standard power versions (Centre Magnetron only)

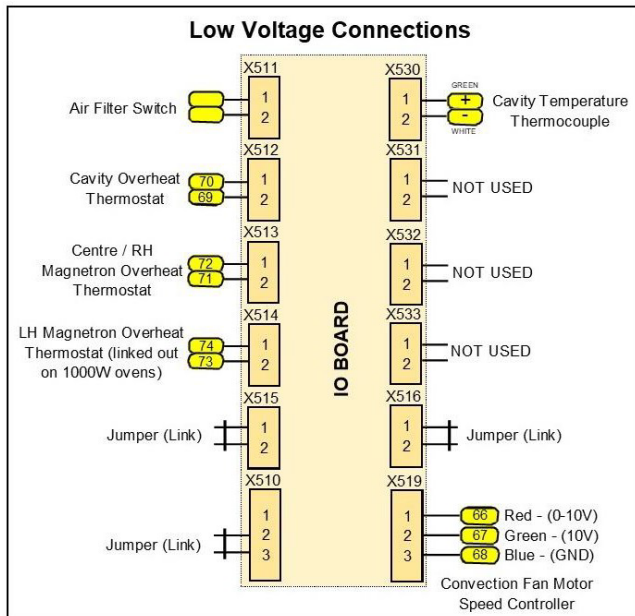

- X514. Link fitted
- X112. Pins 1 & 2 not used
- X411. Not used

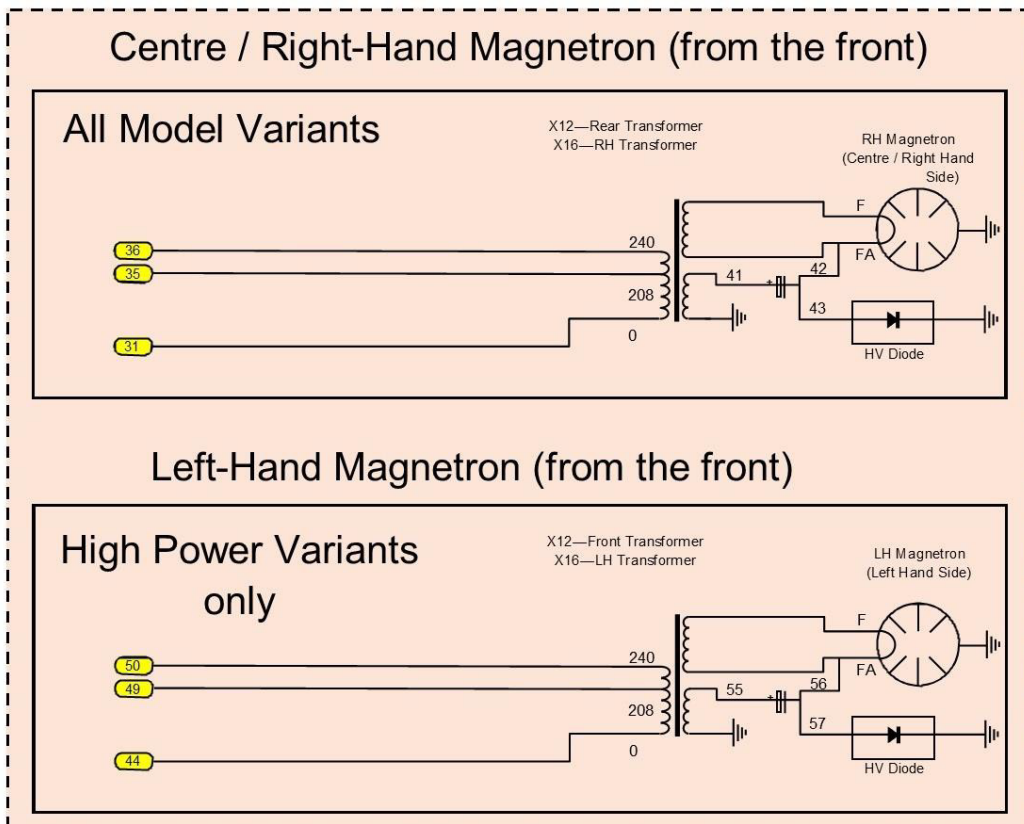
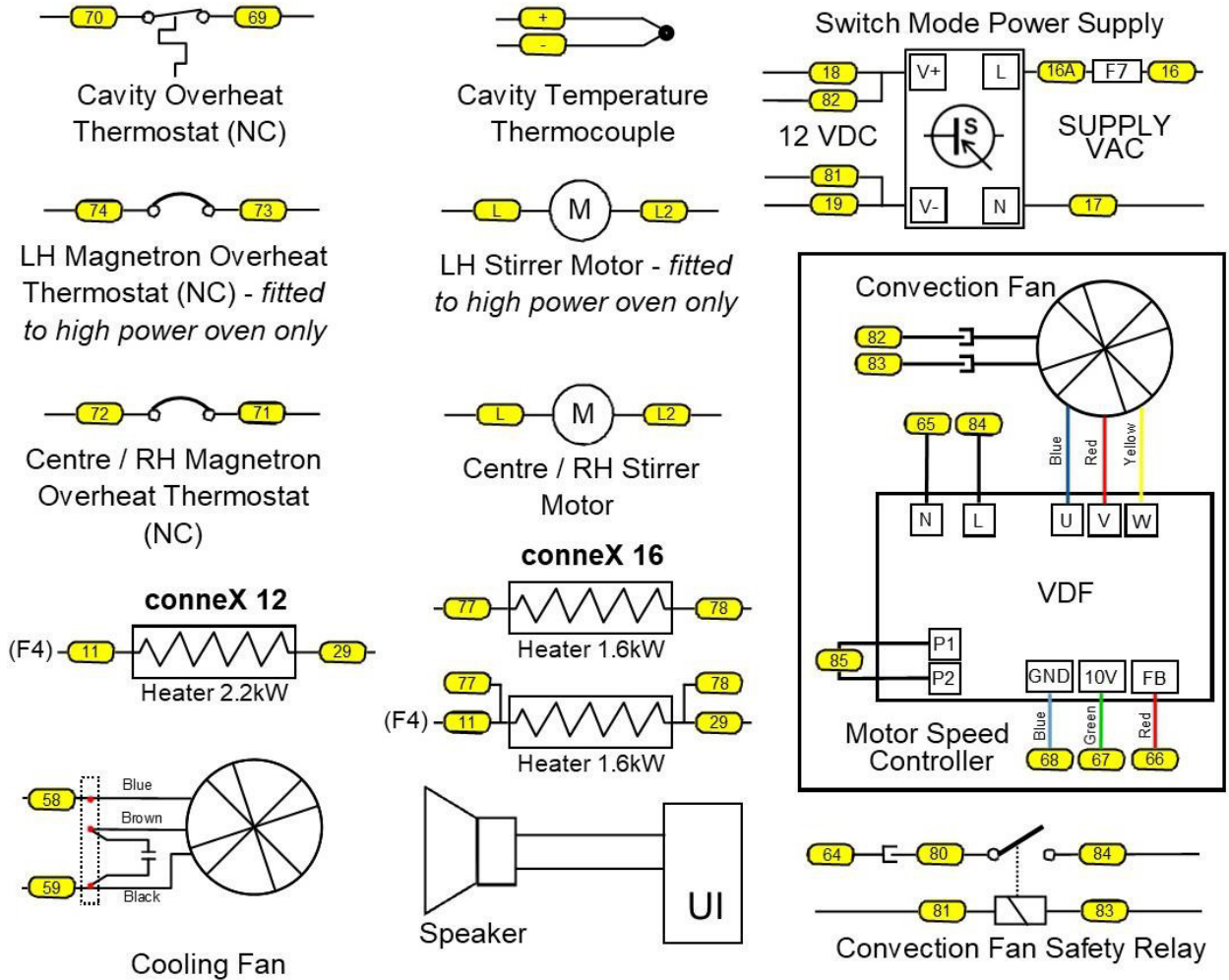

8 Annual PM check procedure for connex®

Task(s): Annual Technician PM check
Frequency: Annual
Time to complete: 1-3 hours
Model(s): Merrychef connex 12 & 16

Safety information:
 Please adhere to all Merrychef safety aspects at all times.



Electricity



Manual handling



Hot liquids

Service procedures

- All tests to be carried out by a trained Merrychef technician.
- Ensure all documented safety procedures are followed for each individual task.
- Refer to the relevant section within this manual for task details.

Task A



1. Check the oven for obvious signs of damage and cleanliness. Switch the oven on and off with front switch, allow to cool down.

2. Check the power cord and plug for damage and replace if required.

3. Remove the air filter and check for damage, clean and insert or replace if required.

4. Remove cook plate and check for damage, clean and insert or replace if required.

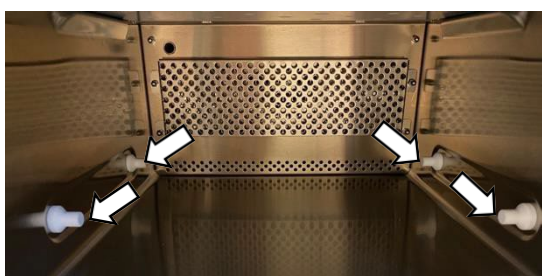

5. Inspect the 4 studs for signs of carbon and arching, Remove the side panels and replace as required.



6. Check the door seal, ensuring that it is intact, not hanging loose or have any sections broken away or cracked. Replace if required and allow silicone to cure.



7. Remove & refit upper impinger plate inspecting for cleanliness and signs of damage (if required follow the instructions laid out in the replacement impinger Kit). Visually check the partition plate for signs of discolouration or damage.

Task B



8. Switch the oven on and record the Serial Number. Check the firmware is correct, update if older version is observed (select the 'cog' to enter settings).

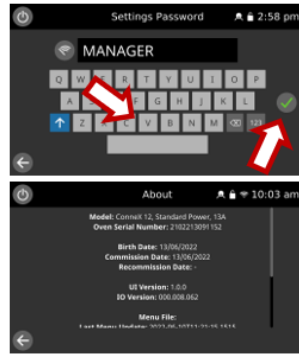

9. Enter the password MANAGER to access the settings menu. Use the displayed oven serial number if this is invalid.

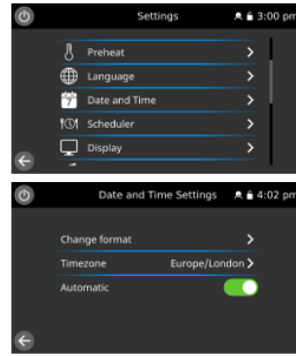

10. Check the date, time, and the time zone, correct if necessary. Refer to the Installation and User manual for details on the procedure.

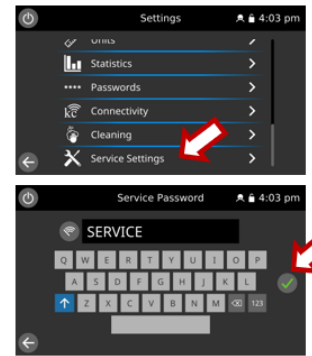

11. Enter the service settings, password SERVICE to access the service screen. Use the displayed oven serial number if this is invalid.

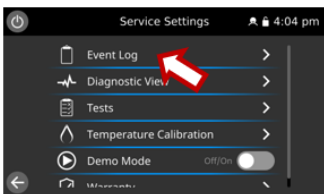

12. Check the "Event Log" for details of any logged appliance errors. Refer to the fault-finding section 5.3 to reference any errors logged.

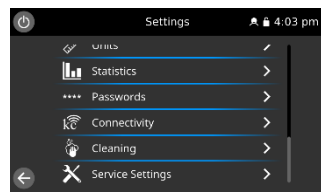

13. Select the oven statistics and reference the service check sheet for recommended replacements, advise the customer on actions required.

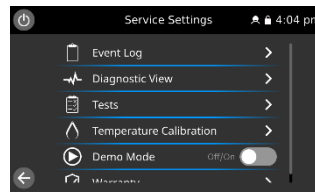

14. Select the diagnostic view to perform individual component checks.

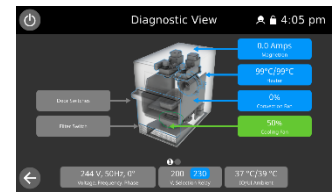

15. In diagnostic view select/operate each component to check operation, as detailed in the visual view section 5.2. Check all speed ranges of the fans. Record microwave (individual & combined) current draws. Record displayed Voltage.

Note: ensure a bowl of coldwater is in the cavity for the microwave current draw checks.

16. Exit out of visual view, place a bowl with 275 ml of cold water in the cavity and select tests / Microwave Leakage. While the test is running hold the test probe at right angles to the oven, ensuring the sensor is about 50mm away from the surface. Test all around the front and rear of the oven, refer to section 5.6 for further details. Level must be 5mW/cm² or lower & record.

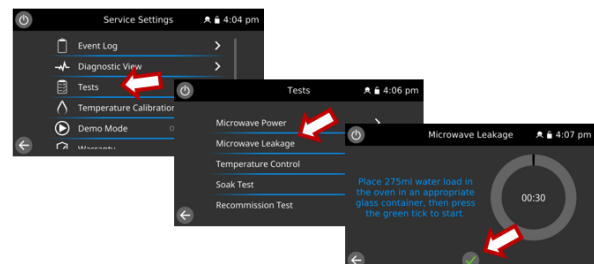

17. Finally, remove the bowl of water from inside the cavity and select the recommission test (if the recommission test is greyed out, it means the oven is above the desired temperature and the function is disabled). Follow the onscreen instructions and record result.

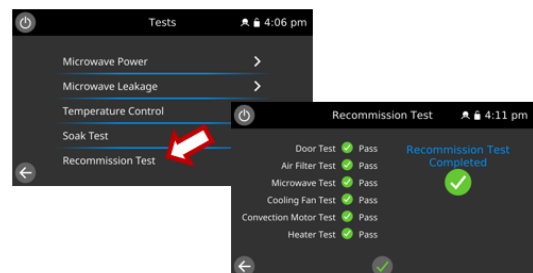

18. Come out of the service and setting modes. Pre-heat the oven and cook one item of food from the operators' menu.

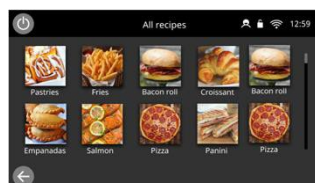

Planned preventative maintenance schedule for the Merrychef connex® commercial combination oven			Daily	12 months	24 months	36 months	Comments
Item	Description	Commissioning	Operator	OCIE check			See latest parts manual for part numbers
1	Check installation and surroundings as per installation instructions	●	●	●	●	●	
2	Check cook baskets for damage and replace if required.	●	●	●	●	●	For operator to check
3	Check oven cook plate		●	●	●	●	If damaged replace cook plate and studs
4	Check air filter and clean	●	●	●	●	●	Oven can be damaged if missing
5	Inspect impinger plate, replace as required			●	●	●	Replace every 24 Months or when damaged
6	Inspect partition plate			●	●	●	Replace if damaged
7	Visually check oven for damage			●	●	●	Document findings
8	Check condition of mains lead and plug			●	●	●	Replace mains lead if damaged. Check oven model for service part number.
9	Clean oven as per user instructions		●				
10	Check and clean steam vent pipe			●	●	●	
11	Check door seal condition and replace as required		●	●	●	●	Replace every 24 Months or when damaged
12	Check door operation	●	●	●	●	●	
13	Check on/off switch operation		●	●	●	●	
14	Check oven serial number & firmware revisions	●		●	●	●	Update firmware is older version(s) displayed
15	Check touch screen condition and operation		●	●	●	●	
17	Check date & time	●		●	●	●	Update as required
18	Check and record oven counter screen			●	●	●	
19	Check & record amp draw, heating element and magnetron(s)			●	●	●	
20	Check operation oven components			●	●	●	
21	Check stirrer motor(s) is rotating			●	●	●	Listen with all other components switched off
22	Check oven temperature calibration	●		●	●	●	Check cavity temperature is in range
23	Unplug and isolate (LOTO)			●	●	●	
24	Remove all panels and discharge the HV Capacitor(s)			●	●	●	
25	Check all internal electrical connections for tightness and condition			●	●	●	
26	Check magnetron(s) and cooling duct			●	●	●	Replace magnetron(s) every 36 months or every 1500 Mag Hours
27	Check door switch condition and adjustment			●	●	●	Replace 24 Months or when damaged
28	Vacuum out casework			●	●	●	
29	Refit all panels and plug the unit in to the electrical supply. Switch the oven on			●	●	●	
30	Check & download error log file			●	●	●	
31	Download cook count file			●	●	●	
32	Check for microwave leakage	●		●	●	●	
33	Complete recommission test and service report	●		●	●	●	
34	Pre-heat the oven and cook one item of food from the operators' menu.	●	●	●	●	●	
Total hrs/mins			0.5hrs	1hr	2hrs	3hrs	

● = Mandatory checks that can be completed in visual view and should only take 15min to attend to and record findings in the comments column

● = Mandatory

■ = Optional outside of PM requirement

Microwave Combination Oven

Merrychef conneX®

Part Number 32Z9170

Version 1



Welbilt offers fully-integrated kitchen systems and our products are backed by KitchenCare® aftermarket parts and service. Welbilt's portfolio of award-winning brands includes **Cleveland™, Convothem®, Crem®, Delfield®, fitkitchen®, Frymaster®, Garland®, Kolpak®, Lincoln®, Manitowoc®, Merco®, Merrychef® and Multiplex®.**

Bringing innovation to the table • **welbilt.com**