



MADE IN ITALY

# CATALOGO GENERALE

## *GENERAL CATALOGUE*



CP



CS



CV



CQ



SG



SPS

# ICE

# ALSTARCO

## CHI SIAMO WHO WE ARE



### ESPERIENZA E QUALITÀ DA PIÙ DI CINQUANT'ANNI

Grazie all'**esperienza nel settore** delle macchine bar e delle **attrezzature per la ristorazione**, negli **anni 50 Beniamino Aristarco fonda l'azienda** che successivamente prenderà il nome di famiglia.

Competenza, qualità industriale e ricerca continua contraddistinguono l'azienda da allora. Dal 2013, grazie al suo know-how, **Aristarco affina la produzione di macchine per il ghiaccio nell'ambito della ristorazione**; oggi è una solida realtà imprenditoriale con una struttura di 14.000 m<sup>2</sup>, una capacità produttiva di 30.000 pezzi annui e oltre 80 dipendenti tra operai specializzati, tecnici ed ingegneri.

### EXPERIENCE AND QUALITY FOR MORE THAN FIFTY YEARS

*Thanks to **the experience acquired in the field of bar and catering equipment**, Beniamino Aristarco **founded the company during the 1950s**, that later will take the family name. Competence, industrial standard quality and ongoing research have made the company stand out since then.*







*As of 2013, thanks to its know-how, **Aristarco has developed the production of ice machines for the professional use in the catering field**: today is a well established enterprise with premises of 14.000 m<sup>2</sup>, operating with a manufacturing capacity of up to 30,000 units per annum, employing more than 80 skilled workers, technicians and engineers.*



## CAMPI DI APPLICAZIONE FIELDS OF APPLICATION

A sostegno di una rapida consultazione del catalogo prodotti, abbiamo sintetizzato in questa tabella i campi d'impiego relativi alle nostre tipologie di ghiaccio, secondo una scala di valore.

The following table is an easy reference summarising the ice type applications from the catalogue specifications. At a glance, a gradual scale shows the most suitable applications for each ice type.

						
	18 gr Cubetto pieno Full ice cube	36 gr Cubetto pieno Full ice cube	21 gr Cubetto vuoto Hollow ice cube	6/10/17 gr Cubetto quadro Dice ice	- Ghiaccio granulare Granular ice	- Scaglie piatte Flat ice flakes
Hotels	■■■■	■■■■	■■■■	■□□□	■■■■	□□□□
Restaurants	■■■■	■■■■	■■■■	■□□□	■■■■	■□□□
Fast Food	■□□□	■□□□	■□□□	■■■■	■■■□	□□□□
Bars	■■■■	■■■■	■■■■	■■■□	■■■□	□□□□
Discos	■■■■	■■■■	■□□□	■■■■	■■■□	□□□□
Spas	□□□□	□□□□	□□□□	□□□□	■■■■	■□□□
Fish Markets	□□□□	□□□□	□□□□	□□□□	■■■■	■■■■
Supermarkets	□□□□	□□□□	□□□□	■□□□	■■■■	■■■■
Medical	□□□□	□□□□	□□□□	□□□□	■■■■	■□□□
Industrial	□□□□	□□□□	□□□□	■□□□	■■■■	■■■■

07		<b>CP</b>	<b>CUBETTO PIENO</b> FULL ICE CUBE	18 gr	
19		<b>CS</b>	<b>CUBETTO PIENO</b> FULL ICE CUBE	36 gr	
29		<b>CV</b>	<b>CUBETTO VUOTO</b> HOLLOW ICE CUBE	21 gr	
35		<b>CQ</b>	<b>CUBETTO QUADRO</b> DICE ICE	6/10/17 gr	
39		<b>SG</b>	<b>GHIACCIO GRANULARE</b> GRANULAR ICE		
45		<b>SPS</b>	<b>SCAGLIE PIATTE</b> FLAT ICE FLAKES		
51		<b>ST</b>	<b>DEPOSITI</b> ICE BINS		

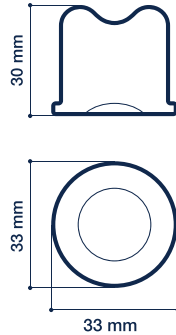

**Cubetto pieno 18 gr**  
*Full ice cube 18 gr*



**CARATTERISTICHE DI GAMMA**  
*RANGE FEATURES*



I fabbricatori di ghiaccio a cubetto pieno della **gamma CP**, costruiti completamente in acciaio inox, rappresentano il top della gamma Aristarco e incorporano tutte le ultime tecnologie per garantire sempre il massimo delle prestazioni e lunga durata nel tempo.

La formazione dei cubetti avviene attraverso l'aspersione d'acqua su di un evaporatore orizzontale in rame il quale, raffreddandosi, forma dei cubetti di ghiaccio ad alta densità puri e cristallini.

Il **cubetto pieno**, più puro dell'acqua da cui deriva, è il più indicato per il raffreddamento prolungato di qualsiasi bevanda, senza annacquarela, in qualsiasi situazione d'uso.

*The **CP series** solid cube ice makers are made entirely of stainless steel. They are top of the Aristarco range and incorporate all the latest technology to ensure maximum efficiency and enduring performance.*

*The ice cube is formed by water being sprinkled onto a horizontally mounted copper evaporator which then cools off forming high density, pure, crystal clear, solid ice cubes. These **solid ice cubes** end up purer than the water from which they are made and are ideally suitable for keeping drinks cool for an extended time frame without watering them down.*



18 gr



**CUBETTO PIENO 18 gr**  
*FULL ICE CUBE 18 gr*



## Modello - Model

---

Dimensioni (LxPxH) - Dimensions (WxDxH)

Produzione in 24h - 24 hr production ( $\hat{c}$  21° C -  $\Delta$  15° C)

Capacità di immagazzinamento - Storage capacity

Sistema di raffreddamento - Cooling system

Potenza assorbita - Power consumption

Peso netto - Net weight

**W** = Raffreddamento ad acqua - Water cooled

**A** = Raffreddamento ad aria - Air cooled

Piedino regolabile/Adjustable foot = 0 ÷ 20 mm

### CP 20.6

UNDER COUNTER

365 x 495 x 600 mm

20 Kg ( $\approx$  1111  $\Delta$ )

6 Kg ( $\approx$  333  $\Delta$ )

A/W

450 W

32 Kg

### CP 25.6

UNDER COUNTER

365 x 495 x 600 mm

25 Kg ( $\approx$  1388  $\Delta$ )

6 Kg ( $\approx$  333  $\Delta$ )

A/W

450 W

32,5 Kg

### CP 30.10

UNDER COUNTER

365 x 495 x 690 mm

30 Kg ( $\approx$  1666  $\Delta$ )

10 Kg ( $\approx$  555  $\Delta$ )

A/W

450 W

34 Kg



18 gr



**CUBETTO PIENO 18 gr**  
*FULL ICE CUBE 18 gr*



## Modello - Model

Dimensioni (LxPxH) - Dimensions (WxDxH)

Produzione in 24h - 24 hr production (â 21° C - ð 15° C)

Capacità di immagazzinamento - Storage capacity

Sistema di raffreddamento - Cooling system

Potenza assorbita - Power consumption

Peso netto - Net weight

**W** = Raffreddamento ad acqua - Water cooled

**A** = Raffreddamento ad aria - Air cooled

Piedino regolabile/Adjustable foot = 0 ÷ 20 mm

### **CP 40.15** UNDER COUNTER

500 x 585 x 685 mm

40 Kg (≈ 2222 □)

15 Kg (≈ 833 □)

A/W

570 W

45 Kg

### **CP 45.15** UNDER COUNTER

500 x 585 x 685 mm

45 Kg (≈ 2500 □)

15 Kg (≈ 833 □)

A/W

600 W

46 Kg

### **CP 50.25** UNDER COUNTER

500 x 585 x 795 mm

50 Kg (≈ 2778 □)

25 Kg (≈ 1389 □)

A/W

750 W

49 Kg



18 gr



**CUBETTO PIENO 18 gr**  
*FULL ICE CUBE 18 gr*



## Modello - Model

Dimensioni (LxPxH) - Dimensions (WxDxH)

Produzione in 24h - 24 hr production ( $\hat{c}$  21° C -  $\Delta$  15° C)

Capacità di immagazzinamento - Storage capacity

Sistema di raffreddamento - Cooling system

Potenza assorbita - Power consumption

Peso netto - Net weight

**W** = Raffreddamento ad acqua - Water cooled  
**A** = Raffreddamento ad aria - Air cooled  
Piedino regolabile/Adjustable foot = 40 ÷ 50 mm

### **CP 60.40** BACK COUNTER

740 x 605 x 915 mm

60 Kg ( $\approx$  3333  $\Delta$ )

40 Kg ( $\approx$  2222  $\Delta$ )

A/W

780 W

72 Kg

### **CP 85.40** BACK COUNTER

740 x 605 x 915 mm

85 Kg ( $\approx$  4722  $\Delta$ )

40 Kg ( $\approx$  2222  $\Delta$ )

A/W

1050 W

79 Kg

### **CP 100.60** BACK COUNTER

740 x 605 x 1015 mm

100 Kg ( $\approx$  5556  $\Delta$ )

60 Kg ( $\approx$  3333  $\Delta$ )

A/W

1200 W

82 Kg



18 gr



**CUBETTO PIENO 18 gr**  
*FULL ICE CUBE 18 gr*



## Modello - Model

Dimensioni (LxPxH) - Dimensions (WxDxH)

Produzione in 24h - 24 hr production (at 21° C - Δ 15° C)

Capacità di immagazzinamento - Storage capacity

Sistema di raffreddamento - Cooling system

Potenza assorbita - Power consumption

Peso netto - Net weight

**W** = Raffreddamento ad acqua - Water cooled

**A** = Raffreddamento ad aria - Air cooled

Piedino regolabile/Adjustable foot = 40 ÷ 50 mm

**CP 130.75**  
BACK COUNTER

840 x 745 x 1070 mm

130 Kg (≈ 7222 Δ )

75 Kg (≈ 4167 Δ )

A/W

1250 W

105 Kg

**CP 165.75**  
BACK COUNTER

840 x 745 x 1070 mm

165 Kg (≈ 9167 Δ )

75 Kg (≈ 4167 Δ )

A/W

1900 W

107 Kg





18 gr



**CUBETTO PIENO 18 gr**  
*FULL ICE CUBE 18 gr*

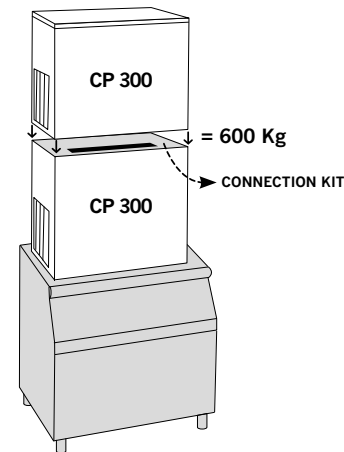

## Modello - Model

Dimensioni (LxPxH) - Dimensions (WxDxH)

Produzione in 24h - 24 hr production ( $\hat{c}$  21° C -  $\Delta$  15° C)

Sistema di raffreddamento - Cooling system

Potenza assorbita - Power consumption

Peso netto - Net weight

Deposito utilizzabile - Usable bin

**W** = Raffreddamento ad acqua - Water cooled  
**A** = Raffreddamento ad aria - Air cooled

### CP 165 BACK STAGE

865 x 560 x 810 mm

165 Kg ( $\approx$  9167  $\Delta$ )

A/W

1900 W

94 Kg

ST S 250 - ST S 400

### CP 300 BACK STAGE

1255 x 595 x 860 mm

300 Kg ( $\approx$  16667  $\Delta$ )

A/W

2700 W

148 Kg

ST S 400

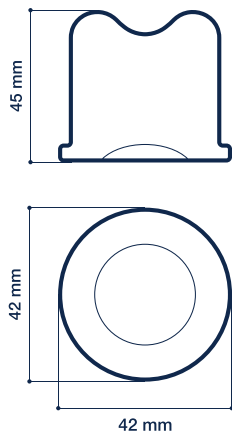

**Cubetto pieno 36 gr**  
*Full ice cube 36 gr*



## CARATTERISTICHE DI GAMMA

### RANGE FEATURES

I fabbricatori di ghiaccio a cubetto pieno della **gamma CS**, costruiti completamente in acciaio inox, rappresentano il top della gamma Aristarco e incorporano tutte le ultime tecnologie per garantire sempre il massimo delle prestazioni e lunga durata nel tempo.

La formazione dei cubetti avviene attraverso l'aspersione d'acqua su di un evaporatore orizzontale in rame il quale, raffreddandosi, forma dei cubetti di ghiaccio ad alta densità puri e cristallini. Il **cubetto pieno**, più puro dell'acqua da cui deriva, è il più indicato per il raffreddamento prolungato di qualsiasi bevanda, senza annacquarela, in qualsiasi situazione d'uso.

*The **CS series** solid cube ice makers are made entirely of stainless steel. They are top of the Aristarco range and incorporate all the latest technology to ensure maximum efficiency and enduring performance.*

*The ice cube is formed by water being sprinkled onto a horizontally mounted copper evaporator which then cools off forming high density, pure, crystal clear, solid ice cubes. These **solid ice cubes** end up purer than the water from which they are made and are ideally suitable for keeping drinks cool for an extended time frame without watering them down.*

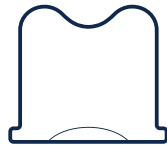

36 gr



**CUBETTO PIENO 36 gr**  
*FULL ICE CUBE 36 gr*



## Modello - Model

---

Dimensioni (LxPxH) - Dimensions (WxDxH)

Produzione in 24h - 24 hr production ( $\hat{c}$  21° C -  $\Delta$  15° C)

Capacità di immagazzinamento - Storage capacity

Sistema di raffreddamento - Cooling system

Potenza assorbita - Power consumption

Peso netto - Net weight

**W** = Raffreddamento ad acqua - Water cooled

**A** = Raffreddamento ad aria - Air cooled

Piedino regolabile/Adjustable foot = 0 ÷ 20 mm

**CS 25.6**  
UNDER COUNTER

365 x 495 x 600 mm

25 Kg ( $\approx$  625  $\Delta$ )

6 Kg ( $\approx$  167  $\Delta$ )

A/W

450 W

32 Kg

**CS 30.10**  
UNDER COUNTER

365 x 495 x 690 mm

30 Kg ( $\approx$  750  $\Delta$ )

10 Kg ( $\approx$  278  $\Delta$ )

A/W

450 W

34 Kg

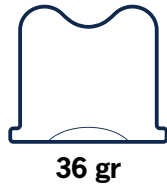

**CUBETTO PIENO 36 gr**  
*FULL ICE CUBE 36 gr*



## Modello - Model

Dimensioni (LxPxH) - Dimensions (WxDxH)

Produzione in 24h - 24 hr production (± 21° C - Δ 15° C)

Capacità di immagazzinamento - Storage capacity

Sistema di raffreddamento - Cooling system

Potenza assorbita - Power consumption

Peso netto - Net weight

**W** = Raffreddamento ad acqua - Water cooled

**A** = Raffreddamento ad aria - Air cooled

Piedino regolabile/Adjustable foot = 0 ÷ 20 mm

### **CS 37.15** UNDER COUNTER

500 x 585 x 685 mm

37 Kg (≈ 1028 □)

15 Kg (≈ 417 □)

A/W

570 W

45 Kg

### **CS 45.15** UNDER COUNTER

500 x 585 x 685 mm

45 Kg (≈ 1250 □)

15 Kg (≈ 417 □)

A/W

600 W

46 Kg

### **CS 50.25** UNDER COUNTER

500 x 585 x 795 mm

50 Kg (≈ 1390 □)

25 Kg (≈ 694 □)

A/W

750 W

49 Kg

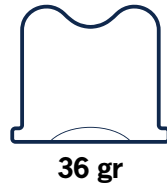

**CUBETTO PIENO 36 gr**  
*FULL ICE CUBE 36 gr*



## Modello - Model

Dimensioni (LxPxH) - Dimensions (WxDxH)

Produzione in 24h - 24 hr production ( $\hat{c}$  21° C -  $\Delta$  15° C)

Capacità di immagazzinamento - Storage capacity

Sistema di raffreddamento - Cooling system

Potenza assorbita - Power consumption

Peso netto - Net weight

### **CS 60.40** BACK COUNTER

740 x 605 x 915 mm

60 Kg ( $\approx$  1667  $\Delta$ )

40 Kg ( $\approx$  1111  $\Delta$ )

A/W

780 W

72 Kg

### **CS 80.40** BACK COUNTER

740 x 605 x 915 mm

80 Kg ( $\approx$  2222  $\Delta$ )

40 Kg ( $\approx$  1111  $\Delta$ )

A/W

1050 W

79 Kg

### **CS 90.60** BACK COUNTER

740 x 605 x 1015 mm

90 Kg ( $\approx$  2500  $\Delta$ )

60 Kg ( $\approx$  1667  $\Delta$ )

A/W

1200 W

82 Kg

### **CS 130.75** BACK COUNTER

840 x 745 x 1070 mm

130 Kg ( $\approx$  3611  $\Delta$ )

75 Kg ( $\approx$  2083  $\Delta$ )

A/W

1250 W

107 Kg

**W** = Raffreddamento ad acqua - Water cooled  
**A** = Raffreddamento ad aria - Air cooled  
Piedino regolabile/Adjustable foot = 40 ÷ 50 mm

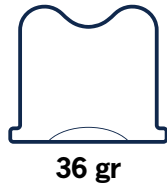

**CUBETTO PIENO 36 gr**  
*FULL ICE CUBE 36 gr*

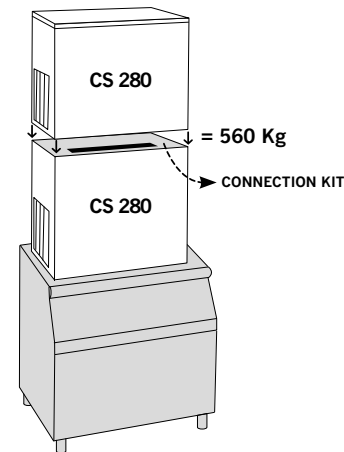

## Modello - Model

Dimensioni (LxPxH) - Dimensions (WxDxH)

Produzione in 24h - 24 hr production ( $\hat{c}$  21° C -  $\Delta$  15° C)

Sistema di raffreddamento - Cooling system

Potenza assorbita - Power consumption

Peso netto - Net weight

Deposito utilizzabile - Usable bin

**W** = Raffreddamento ad acqua - Water cooled  
**A** = Raffreddamento ad aria - Air cooled

### CS 140

BACK STAGE

865 x 560 x 810 mm

140 Kg ( $\approx$  3889  $\Delta$ )

A/W

1900 W

94 Kg

ST S 250 - ST S 400

### CS 280

BACK STAGE

1255 x 595 x 860 mm

280 Kg ( $\approx$  7778  $\Delta$ )

A/W

2700 W

148 Kg

ST S 400

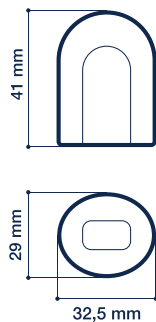

**Cubetto vuoto 21 gr**  
*Hollow ice cube 21 gr*



## CARATTERISTICHE DI GAMMA

RANGE FEATURES



I fabbricatori di ghiaccio a cubetto vuoto della **gamma CV**, costruiti completamente in acciaio inox, con deposito incorporato e grande capacità produttiva si caratterizzano per il design moderno e accattivante, e per la compattezza delle dimensioni che facilita il loro collocamento. Il sistema di produzione a palette con evaporatore a peduncoli è l'unico sistema in grado di garantire il corretto funzionamento del fabbricatore di ghiaccio anche in presenza di acque particolarmente dure, ricche di calcare ed impurità.

Il **cubetto cavo**, dotato di un'ampia superficie refrigerante, è particolarmente indicato per raffreddare rapidamente le bevande a consumo immediato. La presenza del foro interno facilita la triturazione, rendendolo quindi ideale per un impiego nei cocktail pestati.

*The **CV series** hollow ice cube makers, made entirely of stainless steel, have an incorporated storage space and boast a significant production capacity. This range stands out for its contemporary and striking design and for its compact size facilitating its positioning. The paddle production system with fingers evaporator ensures ultimate performance even in the presence of particularly hard water with elevated amounts of limestone and impurities.*

*The **hollow cubes** have a more extended cooling surface therefore are especially suitable for the fast cooling of beverages intended for immediate consumption. Their hollow shape makes them easy to crush hence ideal for use in many types of cocktails.*



21 gr



**CUBETTO VUOTO 21 gr**  
HOLLOW ICE CUBE 21 gr



## Modello - Model

Dimensioni (LxPxH) - Dimensions (WxDxH)

Produzione in 24h - 24 hr production (at 21° C - Δ 15° C)

Capacità di immagazzinamento - Storage capacity

Sistema di raffreddamento - Cooling system

Potenza assorbita - Power consumption

Peso netto - Net weight

### CV 20.5

UNDER COUNTER

340 x 545 x 620 mm

20 Kg (≈ 952 @)

5 Kg (≈ 238 @)

A/W

220 W

36 Kg

### CV 25.7

UNDER COUNTER

340 x 545 x 690 mm

25 Kg (≈ 1190 @)

7 Kg (≈ 333 @)

A/W

200 W

37 Kg

### CV 35.12

UNDER COUNTER

450 x 545 x 690 mm

35 Kg (≈ 1666 @)

12 Kg (≈ 571 @)

A/W

230 W

37 Kg

### CV 45.16

UNDER COUNTER

500 x 600 x 690 mm

45 Kg (≈ 2143 @)

16 Kg (≈ 762 @)

A/W

240 W

41 Kg

**W** = Raffreddamento ad acqua - Water cooled

**A** = Raffreddamento ad aria - Air cooled

Piedino regolabile/Adjustable foot = 0 ÷ 10 mm





21 gr



**CUBETTO VUOTO 21 gr**  
HOLLOW ICE CUBE 21 gr



## Modello - Model

Dimensioni (LxPxH) - Dimensions (WxDxH)

Produzione in 24h - 24 hr production (± 21° C - Δ 15° C)

Capacità di immagazzinamento - Storage capacity

Sistema di raffreddamento - Cooling system

Potenza assorbita - Power consumption

Peso netto - Net weight

**W** = Raffreddamento ad acqua - Water cooled

**A** = Raffreddamento ad aria - Air cooled

Piedino regolabile/Adjustable foot = 80 ÷ 100 mm

**CV 50.21**  
BACK COUNTER

500 x 585 x 876 mm

50 Kg (≈ 2380 📏)

21 Kg (≈ 1000 📏)

A/W

310 W

58 Kg

**CV 60.28**  
BACK COUNTER

600 x 585 x 880 mm

60 Kg (≈ 2857 📏)

28 Kg (≈ 1333 📏)

A/W

460 W

60 Kg

**CV 90.40**  
BACK COUNTER

800 x 585 x 880 mm

90 Kg (≈ 4285 📏)

40 Kg (≈ 1904 📏)

A/W

600 W

76 Kg

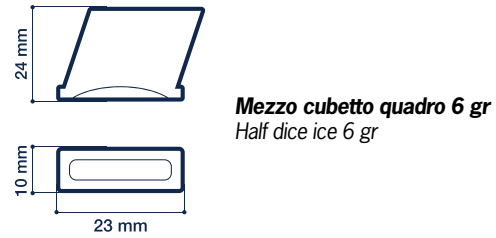

**Mezzo cubetto quadro 6 gr**  
Half dice ice 6 gr

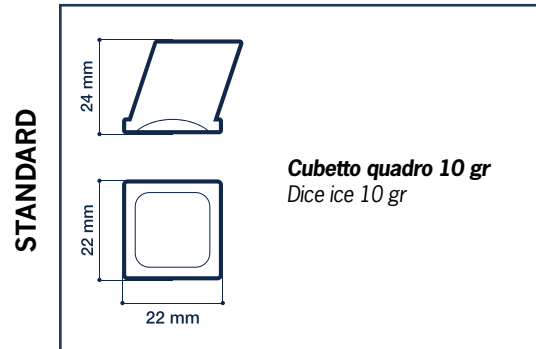

**Cubetto quadro 10 gr**  
Dice ice 10 gr

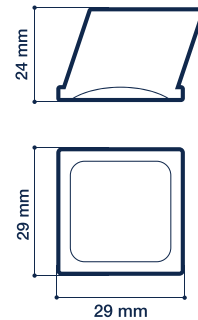

**Cubetto quadro 17 gr**  
Dice ice 17 gr



**CARATTERISTICHE DI GAMMA**  
RANGE FEATURES

I fabbricatori di ghiaccio a cubetto quadro con evaporatore verticale della **gamma CQ**, costruiti completamente in acciaio inox, si caratterizzano per il design lineare ed innovativo e per un'elevata affidabilità. La formazione dei cubetti avviene attraverso un getto uniforme e continuo di acqua che, scorrendo per caduta, viene distribuita su di un evaporatore verticale ad alto rendimento.

Il **cubetto quadro**, dotato di un ottimo potere di raffreddamento, oltre ad essere il più economico da produrre, rappresenta la soluzione migliore per tutte quelle attività con elevato consumo di ghiaccio.

*The **CQ series** solid dice ice makers feature a vertically mounted evaporator made entirely of stainless steel and an innovative linear design and extreme reliability. The ice cubes are produced by means of a uniform and continuous jet of water which flows downwards onto a highly efficient vertical evaporator where it is distributed uniformly.*

*The **dice shape cube** excels in cooling performance and further to having the lowest production costs, it is the most suitable choice for all situations requiring a high ice consumption.*

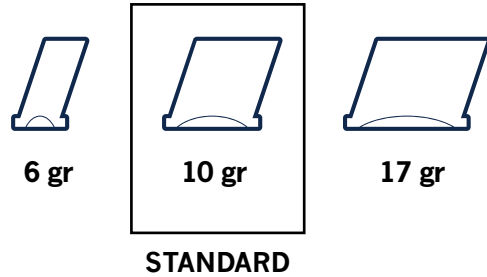

**CUBETTO QUADRO 6/10/17 gr**  
*DICE ICE 6/10/17 gr*



**Modello - Model**

Dimensioni (LxPxH) - Dimensions (WxDxH)

Produzione in 24h - 24 hr production (⌢ 21° C - ⌢ 15° C)

Sistema di raffreddamento - Cooling system

Potenza assorbita - Power consumption

Peso netto - Net weight

Deposito utilizzabile - Usable bin

**W** = Raffreddamento ad acqua - Water cooled  
**A** = Raffreddamento ad aria - Air cooled

<b>CQ 150</b> BACK STAGE	<b>CQ 250</b> BACK STAGE	<b>CQ 320</b> BACK STAGE	<b>CQ 400</b> BACK STAGE	<b>CQ 450</b> BACK STAGE
560 x 620 x 575 mm (≈23300 6 gr)	760 x 620 x 575 mm (≈40000 6 gr)	760 x 620 x 575 mm (≈50000 6 gr)	760 x 620 x 725 mm (≈66600 6 gr)	760 x 620 x 725 mm (≈76600 6 gr)
140 Kg (≈14000 10 gr) (≈8200 17 gr)	240 Kg (≈24000 10 gr) (≈14100 17 gr)	300 Kg (≈30000 10 gr) (≈17600 17 gr)	400 Kg (≈40000 10 gr) (≈23500 17 gr)	450 Kg (≈46000 10 gr) (≈27000 17 gr)
A/W	A/W	A/W	A/W	A/W
850 W	1100 W	1400 W	2100 W	2350 W
53 Kg	68 Kg	70,5 Kg	88 Kg	98 Kg
ST S 150 · ST S 200	ST S 200 · ST S 250 ST S 400	ST S 200 · ST S 250 ST S 400	ST S 200 · ST S 250 ST S 400	ST S 250 · ST S 400



**Ghiaccio granulare**  
Granular ice



SG

## CARATTERISTICHE DI GAMMA

### RANGE FEATURES



I fabbricatori di ghiaccio a scaglie granulari della **gamma SG**, costruiti completamente in acciaio inox, adottano un innovativo concetto della meccanica interna. (Sono disponibili sia versioni con deposito incorporato che con deposito separato). La formazione del ghiaccio granulare avviene tramite un evaporatore cilindrico verticale dotato di una coclea che lo raschia dalla superficie interna e lo porta verso un rompighiaccio, il quale lo fa fuoriuscire abbassandone la quantità di acqua residua.

Il **ghiaccio granulare**, reso disponibile ad una temperatura appena sotto gli 0 °C, contiene un 25% d'acqua residuale. Questa sua caratteristica lo rende ideale per molte applicazioni, dall'esposizione e la presentazione degli alimenti alla creazione di cocktail, dall'utilizzo nei settori chimico e farmaceutico a quello nei centri benessere.

*The **SG series** granular ice makers, entirely made of stainless steel, boast an innovative mechanical concept. These ice makers are available either with built-in or separate ice storage bins. To produce granular ice an Archimedean screw's rotating blade scrapes the ice off the inner surface of a vertical cylindrical evaporator and then moves it into an ice crusher which processes it, lowering its residual water content.*

***Granular ice** is obtained at just below 0 °C with 25% residual water. This feature makes it suitable for a number of uses ranging from food display and presentation, to the preparation of numerous cocktails, as well as use in the chemical and pharmaceutical industries and for therapeutic use in wellness centers.*



**GHIACCIO GRANULARE**  
*GRANULAR ICE*



**Modello - Model**

- Dimensioni (LxPxH) - Dimensions (WxDxH)
- Produzione in 24h - 24 hr production (at 21° C - Δ 15° C)
- Capacità di immagazzinamento - Storage capacity
- Sistema di raffreddamento - Cooling system
- Potenza assorbita - Power consumption
- Peso netto - Net weight

**W** = Raffreddamento ad acqua - Water cooled  
**A** = Raffreddamento ad aria - Air cooled  
 Piedino regolabile/Adjustable foot = 40 ÷ 50 mm

**SG 100.15**  
 UNDER COUNTER

500 x 670 x 696 mm  
 100 Kg  
 15 Kg  
 A/W  
 700 W  
 58 Kg

**SG 140.25**  
 UNDER COUNTER

500 x 670 x 796 mm  
 140 Kg  
 25 Kg  
 A/W  
 700 W  
 60 Kg

**SG 140.60**  
 BACK COUNTER

740 x 700 x 934 mm  
 140 Kg  
 60 Kg  
 A/W  
 700 W  
 79 Kg



**GHIACCIO GRANULARE**  
*GRANULAR ICE*



**Modello - Model**

Dimensioni (LxPxH) - Dimensions (WxDxH)

Produzione in 24h - 24 hr production (at 21° C - Δ 15° C)

Sistema di raffreddamento - Cooling system

Potenza assorbita - Power consumption

Peso netto - Net weight

Deposito utilizzabile - Usable bin

**W** = Raffreddamento ad acqua - Water cooled

**A** = Raffreddamento ad aria - Air cooled

**SG 140**

BACK STAGE

560 x 525 x 560 mm

140 Kg

A/W

700 W

47,5 Kg

ST S 150 · ST S 200  
 ST S 250 · ST C 140

**SG 300**

BACK STAGE

560 x 525 x 560 mm

300 Kg

A/W

1300 W

66 Kg

ST S 150 · ST S 200  
 ST S 250 · ST S 400  
 ST C 140 · ST C 300

**SG 600**

BACK STAGE

605 x 570 x 725 mm

600 Kg

A/W

2000 W

102 Kg

ST S 200 · ST S 250  
 ST S 400 · ST SD 500  
 ST C 300 · ST C 600



**Scaglie piatte**  
*Flat ice flakes*

**SPS**

**CARATTERISTICHE DI GAMMA**  
*RANGE FEATURES*



I fabbricatori di ghiaccio a scaglia piatta sottoraffreddata della **gamma SPS**, costruiti completamente in acciaio inox, sono stati pensati e realizzati secondo le più avanzate tecnologie senza trascurare la loro flessibilità d'uso. Oltre alle versioni classiche, Aristarco rende disponibili anche le versioni split. La formazione del ghiaccio a scaglia piatta avviene tramite un evaporatore a cilindro fisso verticale sulla cui superficie viene fatta scorrere dell'acqua che si ghiaccia istantaneamente e, dopo essere stata sottoraffreddata, viene rimossa da un raschiatore.

Il **ghiaccio a scaglia piatta**, caratterizzato da uno spessore di 1,5 mm, esce ad una temperatura che varia dai -5 °C ai -7 °C, che lo rende molto secco. Questa tipologia di ghiaccio risulta quindi ideale per l'utilizzo in processi industriali, esposizione e presentazione degli alimenti, trasporto e conservazione di prodotti alimentari.

*The **SPS series** of flat flake ice makers, with sub-cooling technology are built entirely of stainless steel. This series is manufactured according to the most advanced technology available and features extreme versatility. Two versions are available: the classic and the split. In order to obtain flat ice flakes, a stream of water flows onto a fixed vertical evaporator. This is then sub-cooled freezing the water instantly. At this point the ice is scraped off creating the flakes.*

**Flat ice flakes** feature a 1,5 mm thickness and have a temperature ranging from -5 °C to -7 °C which is very dry. This type of ice is therefore best suited for use in industrial processes, food display and presentation as well as the transport and storage of food products.



**SCAGLIE PIATTE**  
FLAT ICE FLAKES



**Modello - Model**

Dimensioni (LxPxH) - Dimensions (WxDxH)

Produzione in 24h - 24 hr production (at 21° C - Δ 15° C)

Sistema di raffreddamento - Cooling system

Potenza assorbita - Power consumption

Peso netto - Net weight

Deposito utilizzabile - Usable bin

**W** = Raffreddamento ad acqua - Water cooled

**A** = Raffreddamento ad aria - Air cooled

Piedino regolabile / Adjustable foot= 20 ÷ 50 mm

**SPS 250**

BACK STAGE

**SPS 600**

BACK STAGE

**SPS 1000**

BACK STAGE

**SPS 1500**

BACK STAGE

1015 x 590 x 765 mm	1110 x 640 x 800 mm	1110 x 640 x 840 mm	1380 x 740 x 970 mm
250 Kg	600 Kg	1000 Kg	1500 Kg
A	A	A	A
1000 W	2600 W	4500 W	5500 W
170 Kg	205 Kg	231 Kg	381 Kg
ST S 400 · ST SD 500 ST C 600	ST S 400 · ST SD 500 ST SD 1000 · ST C 600	ST S 400 · ST SD 500 ST SD 1000 · ST C 600	ST SD 1000 · ST C 600





**SCAGLIE PIATTE**  
FLAT ICE FLAKES



**Modello - Model**

- Dimensioni (LxPxH) - Dimensions (WxDxH)
- Produzione in 24h - 24 hr production ( $\hat{c}$  21° C -  $\Delta$  15° C)
- Potenza frigorifera richiesta - Required cooling power
- Potenza assorbita - Power consumption
- Peso netto - Net weight
- Deposito utilizzabile - Usable bin

**SPS  
600 Split**

BACK STAGE

600 x 640 x 845 mm  
600 Kg  
2410 W (EN 12900)  
580 W  
115 Kg  
ST S 400 · ST SD 500  
ST C 300 · ST C 600

**SPS  
1000 Split**

BACK STAGE

600 x 640 x 845 mm  
1000 Kg  
4890 W (EN 12900)  
580 W  
160 Kg  
ST S 400 · ST SD 500  
ST SD 1000 · ST C 300  
ST C 600

**SPS  
1500 Split**

BACK STAGE

600 x 640 x 970 mm  
1500 Kg  
6540 W (EN 12900)  
580 W  
235 Kg  
ST S 400 · ST SD 500  
ST SD 1000 · ST C 300  
ST C 600

**W** = Raffreddamento ad acqua - Water cooled  
**A** = Raffreddamento ad aria - Air cooled  
Piedino regolabile/Adjustable foot = 20 ÷ 50 mm

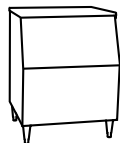

**Depositi**  
*Storage bins*



## CARATTERISTICHE DI GAMMA

RANGE FEATURES



Per garantire una quantità di ghiaccio sufficiente in qualsiasi momento, Aristarco offre un'ampia gamma di depositi di varie dimensioni e capacità, che si **combinano perfettamente con i produttori di ghiaccio modulari di tutte le nostre gamme**. La scelta del modello dipende da vari fattori: dalla dimensione del fabbricatore di ghiaccio, dalla sua capacità produttiva e dallo stock giornaliero di cui si necessita. Un deposito adeguato evita problemi di spazio, consente di lavorare in modo più efficiente con un conseguente risparmio di denaro e di tempo.

Tutti i **depositi Aristarco**, costruiti completamente in acciaio inox, garantiscono un perfetto isolamento e una più duratura conservazione del ghiaccio grazie ad un sistema isolante costituito da una schiuma poliuretana ad alta densità. **Tutti i modelli di depositi Aristarco sono provvisti, dove necessario, di pannello di chiusura superiore compreso nel prezzo.**

*To warrant a sufficient quantity of ice in any given moment, Aristarco offers a wide range of ice storage solutions differing in dimensions and capacity, **perfectly compatible with the modular ice makers of all our ranges**. The choice will depend on a number of factors including the dimensions of the ice maker, the production capacity and the daily quantity requirements. The correct storage solution avoids space problems and enables better work efficiency therefore saving time and money.*

*All **Aristarco storage bins** are made entirely of stainless steel. Their high density polyurethane foam based isolation system, warrants excellent temperature insulation therefore better ice durability. **All models are equipped, when required with a top closing panel which is included in the price.***

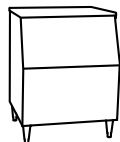

## Modello - Model

Dimensioni (LxPxH) - Dimensions (WxDxH)

Capacità di immagazzinamento - Storage capacity

Peso netto - Net weight

Utilizzabile con - Usable with



### ST S 150

569 x 850 x 1048 mm

130 Kg

36 Kg

SG 140 · 300  
CQ 150



### ST S 200

769 x 850 x 1048 mm

180 Kg

43 Kg

SG 140 · 300 · 600  
CQ 150 · 250 · 320  
400



### ST S 250

1081 x 824 x 968 mm

250 Kg

48 Kg

CP 165  
CS 140  
SG 140 · 300 · 600  
CQ 250 · 320 · 400  
450



### ST S 400

1235 x 873 x 1270 mm

400 Kg

73 Kg

CP 165 · 300  
CS 140 · 280  
SG 300 · 600  
CQ 250 · 320 · 400 · 450  
SPS 250 · 600 · 1000

## Modello - Model

Dimensioni (LxPxH) - Dimensions (WxDxH)

Capacità di immagazzinamento - Storage capacity

Peso netto - Net weight

Utilizzabile con - Usable with



### ST SD 500

1220 x 1128 x 1427 mm

550 Kg

142 Kg

SG 600  
SPS 250 · 600 · 1000



### ST SD 1000

1830 x 1470 x 1290 mm

1060 Kg

212 Kg

SPS 600 · 1000 · 1500

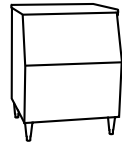

**DEPOSITI**  
STORAGE BINS



**Modello** - Model

Dimensioni (LxPxH) - Dimensions (WxDxH)

Capacità di immagazzinamento - Storage capacity

Capacità carrello - Cart capacity

Peso netto - Net weight

Utilizzabile con - Usable with

**ST C 140**

**ST C 300**

**ST C 600**

885 x 1025 x 1343 mm	885 x 1267 x 1803 mm	1753 x 1267 x 1803 mm
137 Kg	318 Kg	613 Kg
73 Kg	73 Kg	73 Kg (x2)
120 Kg	161 Kg	347 Kg
SG 140 - 300	SG 300 - 600	SG 600 SPS 250 - 600 - 1000 - 1500



**Aristarco S.p.A.**

Via del Lavoro 30 – 31033  
Castelfranco V.to, TV – Italy

**T** + 39 0423 425611

**F** + 39 0423 425690

**CF/PI** IT01823140262



[aristarco.it](http://aristarco.it)

Follow us on:

