

ON-DEMAND ESPRESSO COFFEE GRINDER No. 59

OPERATION AND MAINTENANCE MANUAL



IMPORTANT: documents contained in this manual to be kept:

- "EC" DECLARATION OF CONFORMITY
- WARRANTY CERTIFICATE

Translation of the original version



*Coffee grinders - Fruit juicers - Mixers - Blenders - Drinks dispensers - Planetary mixers
Cheese graters - Ice crushers - Mincers - Vegetable slicers – Dough mixer
Coffee grinders - Fruit presses - Mixers - Blenders - Drink dispensers - Mixer-blenders - Dough mixer -
Cheese graters - Ice crushers - Meat mincers - Vegetable cutters*

REGISTERED DESIGN - FRANCE AND INTERNATIONAL
INTERNATIONALLY PATENTED MODELS

CONTENTS

"EC/EU" DECLARATION OF CONFORMITY.....	3
SAFETY RULES4	
<i>INSTALLATION - HANDLING.....</i>	<i>4</i>
<i>RESTRICTIONS:.....</i>	<i>4</i>
<i>ELECTRICAL CONNECTION:.....</i>	<i>5</i>
<i>Ist USE</i>	<i>5</i>
<i>END-OF-LIFE PRODUCT RECYCLING</i>	<i>6</i>
YOUR ON-DEMAND ESPRESSO COFFEE GRINDER NO. 596	
USING THE APPLIANCE.....	6
<i>FIRST USE:</i>	<i>6</i>
<i>USE:.....</i>	<i>7</i>
Grind setting:.....	7
Setting the dose of ground coffee (timers):	8
Resetting to factory settings	9
<i>GENERAL OPERATIONS OF SCREEN SETTINGS.....</i>	<i>9</i>
<i>CUSTOMISING THE MAIN SCREEN</i>	<i>10</i>
<i>INFORMATION CONCERNING THE COFFEE GRINDER.....</i>	<i>11</i>
<i>"PULSE" FUNCTION</i>	<i>11</i>
<i>BURRS WEAR INDICATOR.....</i>	<i>12</i>
<i>MAIN SCREEN STANDBY MODE.....</i>	<i>13</i>
<i>CLEANING:.....</i>	<i>14</i>
<i>SERVICING</i>	<i>144</i>
Spare parts:	14
Replacing burrs:.....	15
TROUBLESHOOTING ASSISTANCE.....	166
The appliance does not start:	16
The appliance stops because the motor has overheated: (the motor unit is hot).....	16
The appliance stops following an overload:	17
The dose of ground coffee is not even.....	17
The appliance runs without filling the portafilter	17
Espresso coffees tend to be increasingly lighter.....	17
The "Pulse" function stops although the button is still pressed	17
TECHNICAL SPECIFICATIONS OF THE APPLIANCE.....	18
<i>TECHNICAL SPECIFICATIONS.....</i>	<i>18</i>
<i>Electrical diagram 110-120V 50/60Hz and 220-240V 50/60Hz.....</i>	<i>Erreur ! Signet non défini.</i>
<i>Correlation table.....</i>	<i>20</i>
CERTIFICAT DE GARANTIE.....	23
PLAQUE SIGNALÉTIQUE DE L'APPAREIL	23

"EC/EU" DECLARATION OF CONFORMITY

THE MANUFACTURER:

SANTOS SAS - 140-150, Av. Roger SALENGRO 69120 VAULX-EN-VELIN (LYON) FRANCE

Declares that the appliance to be launched on the professional market, hereinafter:

Designation: **On-Demand espresso coffee grinder**
Type Number: **59**

is in compliance:

- with the regulations defined by appendix 1 of the EU "Machinery" Directive **No. 2006/42/EC** and with national implementing legislation.
- with the regulatory provisions of the following European directives and regulations:
 - No. 2014/35/EU (Low Voltage Directive)
 - No. 2014/30/EU (EMC Directive)
 - No. 2014/65/EU (RoHS Directive)
 - No. 2012/19/EU (WEEE Directive)
 - No. 1935/2004/EC (Regulation) concerning materials and articles intended to come into contact with foodstuffs
 - No. 10/2011/EU (Regulation) concerning plastics intended for contact with foodstuffs

Harmonised European standards used to give presumption of conformity with the essential requirements of the directives mentioned above:

- NF EN ISO 12100: 2010, Safety of machinery – General principles for design
- NF EN 60204-1: 2018, Safety of machinery – Electrical equipment of machines – General requirements
- NF EN 1672-2: 2020, Food processing machinery - Basic concepts - Hygiene and cleanability requirements
- NF EN 60335-1: 2013, Safety of household and similar electrical appliances
- NF EN 60335-2-64: 2004, Particular requirements for commercial electric kitchen machines

Issued in VAULX-EN-VELIN on: **01/09/2023**

Title of signatory: **PRESIDENT AND CHIEF EXECUTIVE OFFICER**

Name of signatory: **Aurélien FOUQUET**

Signature:



SAFETY RULES

When using, servicing or disposing of the appliance, always observe the following basic precautions.

Read the complete user manual. Keep this user manual

Note: To facilitate the understanding of the following paragraphs, refer to the diagrams at the end of this manual.

INSTALLATION - HANDLING

Only one person is required for handling the appliance. For ease of use, we recommend placing the appliance on a table or work surface, so as to have the control panel in front of you (recommended height: 90 cm, to be adapted depending on the user).

RESTRICTIONS



1. The appliance is not intended for continuous operation (maximum range of use: 10 seconds on and 20 seconds off).
2. Do not use this appliance to grind anything other than roasted coffee beans.
3. Never let the appliance run without coffee beans in the coffee bean hopper.
4. Remove all foreign bodies from the coffee beans (metal clips, stones, etc.) that can destroy the burrs.
5. To protect against the risk of electrocution, do not immerse the base in water or any other liquid.
6. Cleaning with a hose or pressure cleaner is not allowed.
7. Never touch the moving parts.
8. It is prohibited to operate the appliance on a work surface with a slope greater than 10° to the horizontal plane. The 5 feet of the machine must always be supported on this surface.
9. Unplug the appliance before any intervention on it: cleaning, maintenance or servicing.
10. Do not use the appliance with a damaged power cord. It must be replaced either by an approved SANTOS dealer or the SANTOS company or by similarly qualified persons to avoid any hazards.
11. Use only original SANTOS-certified spare parts.
12. Switch the ON/OFF switch (11) to “ 0 ” when the appliance is not in operation.
13. Do not connect multiple appliances to the same power outlet.
14. Do not use the appliance outdoors.
15. Do not place the appliance near, or on, a heat source.
16. This appliance is a professional appliance intended for professional use only. It is not intended for household use.
17. This appliance can be used by children aged from 8 years and above and persons with reduced physical, sensory or mental capabilities or lack of experience and knowledge if they have been given supervision or instruction

concerning use of the appliance in a safe way and understand the hazards involved. Children shall not play with the appliance. Cleaning and user maintenance shall not be made by children without supervision.

18. This appliance is intended for commercial use, e.g. in restaurant kitchens, canteens, hospitals and small commercial businesses such as bakeries, butchers, etc., but not for the continuous mass production of food.

ELECTRICAL CONNECTION:

- The appliance is available for 3 single-phase voltage supplies:
 - 110-120V 60Hz: model 59V1
 - 220-240V 50Hz: model 59
 - 220-240V 60Hz: model 59V4

Line protection: the appliance must be connected to a standard 2-pole + earth socket. The installation must be equipped with an RCD and a fuse rated at 16A. **The appliance must be earthed.** (fig. B)

CAUTION:



- Before connecting the appliance, check that the mains voltage matches the voltage of your appliance. Its value is indicated:
 - either on the manufacturer's plate (**16**) under the appliance.
 - or on the manufacturer's plate on the last page of this manual.
- If the power cable (**10**) is damaged, it must be replaced by a SANTOS authorized dealer or the SANTOS company, or similarly qualified persons, to avoid danger.

CAUTION:



Check that the on/off switch (**11**) is in the "**0**" position before you connect the power cord plug (**10**) to your AC power outlet. (fig. A).

1st USE

Correctly clean the parts in contact with the coffee (fig. A).

- Remove the cover (**1**), the bean hopper (**2**), the grounds collector (**3**) and wash them with a standard household washing up liquid.

END-OF-LIFE PRODUCT RECYCLING



This appliance is marked with the symbol for the selective sorting of waste electrical and electronic equipment. This means that the product must be taken in hand by a selective collection system in accordance with Directive 2012/19/EU (WEEE) – Business appliances part – to be recycled or dismantled in order to reduce environmental impact.

For more information, please contact your dealer or the SANTOS company.

For disposal or recycling of the components of the appliance, please contact a specialised company or the SANTOS company.

Electronic products that have not been selectively sorted are potentially hazardous to the environment.

Packaging materials must be disposed of or recycled in accordance with the regulations in force.

YOUR ON-DEMAND ESPRESSO COFFEE GRINDER No. 59

- The On-demand espresso coffee grinder No. 59 is intended for bars, cafés, hotels, restaurants. It adapts to all espresso coffee machines.
- The appliance consists of a grinding unit and a base made of aluminium, a bean hopper made of transparent plastic, an electronic system that integrates the dosing, dose counting, the burrs wear indicator.
- The appliance allows roasted coffee to be ground and dispensed instantaneously via electronic dosing.
- The appliance has a screen that displays the logo, number of doses made and the selected button.
- The following adjustments can be made:
 - Grind setting (from Filter, Fine, to Espresso),
 - Setting for the dose of ground coffee dispensed (from 5.5 to about 50g),
 - Adjustments for the screen settings (brightness, standby time, language).
- The appliance is intended exclusively for professional use.

USING THE APPLIANCE

The appliance automatically delivers the dose of coffee instantaneously ground that is required to make:

- 1 espresso coffee (single dose selection),
- 2 espresso coffees (double dose selection),
- A customised dose ("Pulse" selection) (see the "**Pulse function**" part).

FIRST USE:

Assembly and preparation: (fig. A).

1. **Place the grounds collector (3)** on the base (4).
2. **Adjust the height of the portafilter fork (24)** using the screws so that it corresponds to your portafilter
3. **Place the bean hopper (2)** on the adjustment nut of the grinding body (5).

4. **Pour the roasted coffee beans** into the bean hopper and place the cover on the bean hopper.
5. Open the shutter of the bean hopper **(6)**.

USE:

1. Turn the appliance on by turning the On/Off switch **(11)** to **position "1"** (the control panel screen **(19)** displays the SANTOS logo then the main screen) (fig. D).
2. Press the selection button **(20, 21 or 22)** that corresponds to your choice (1 coffee, 2 coffees or the "Pulse" function). (see the "**Selecting the dose**" part).
3. Place the portafilter under the coffee outlet **(23)** using the portafilter fork **(24)**.
4. Press the portafilter Microswitch **(25)** using the portafilter to deliver the desired dose of coffee.
5. The coffee beans are then ground by the burrs and the grind exists from the grinding body to fill the portafilter.
6. Remove the portafilter and tamp the coffee with the tamper **(15)**.

Note: If the 1 coffee button is already selected and you want to make 1 coffee again, it is not necessary to push the 1 coffee button again, simply place the portafilter under the coffee outlet conduit and press the portafilter Microswitch again **(25)** to obtain the selected dose.

If the 1 coffee button is already selected and you want to make 2 coffees, then you must press the 2 coffees button and place the portafilter under the coffee outlet conduit and press the portafilter Microswitch **(25)** to obtain the selected dose.

If the 1 coffee or 2 coffees button is already selected and you want to use the "Pulse" function, refer to the "**Pulse Function**" part with respect to the configured mode.

Grind setting:



CAUTION: Modifying the grind setting always entails setting the timers, see the indicative table in the next chapter:

Note: Never operate the appliance with the two burrs in contact. Putting the burrs in contact can cause the grind to jam in the grinding body and premature wear of the burrs.

The appliance is factory set so that the "**0**" mark on the graduated plate of the nut **(5)** corresponds to the finest grind without the burrs touching each other (fig. C).

The appliance is delivered with the grind set to the espresso type: **mark 14** on the adjustment nut. **(5)**

1. Hold the nut tab **(27)** with one hand and use your other hand to press on the indexing pin **(7)**
2. Tighten the adjustment nut clockwise (right-handed thread) one or two notches for finer grinding.
3. Loosen the adjustment nut anticlockwise (right-handed thread) one or two notches for coarser grinding.

4. Release the indexing pin (7) to lock the nut.
5. Deliver a few doses of coffee to check the grind setting.

The appliance can obtain a very fine grind. You must however make sure, according to the type of coffee used, that the burrs do not come into contact. This would cause the flow to drop substantially and would distort the aroma of the coffee.

Setting the dose of ground coffee (timers):

Clean the ground coffee outlet conduit on (23) a regular basis to prevent blocks of coffee agglomerated on the walls from disturbing the regularity of the dosing of the coffee. (fig. H)



IMPORTANT: Verify or adjust the grind setting before adjusting the timers.
 When adjusting the timer after setting the grind, you can use the following table:
 (Mark of the graduated plate of the Nut (5))

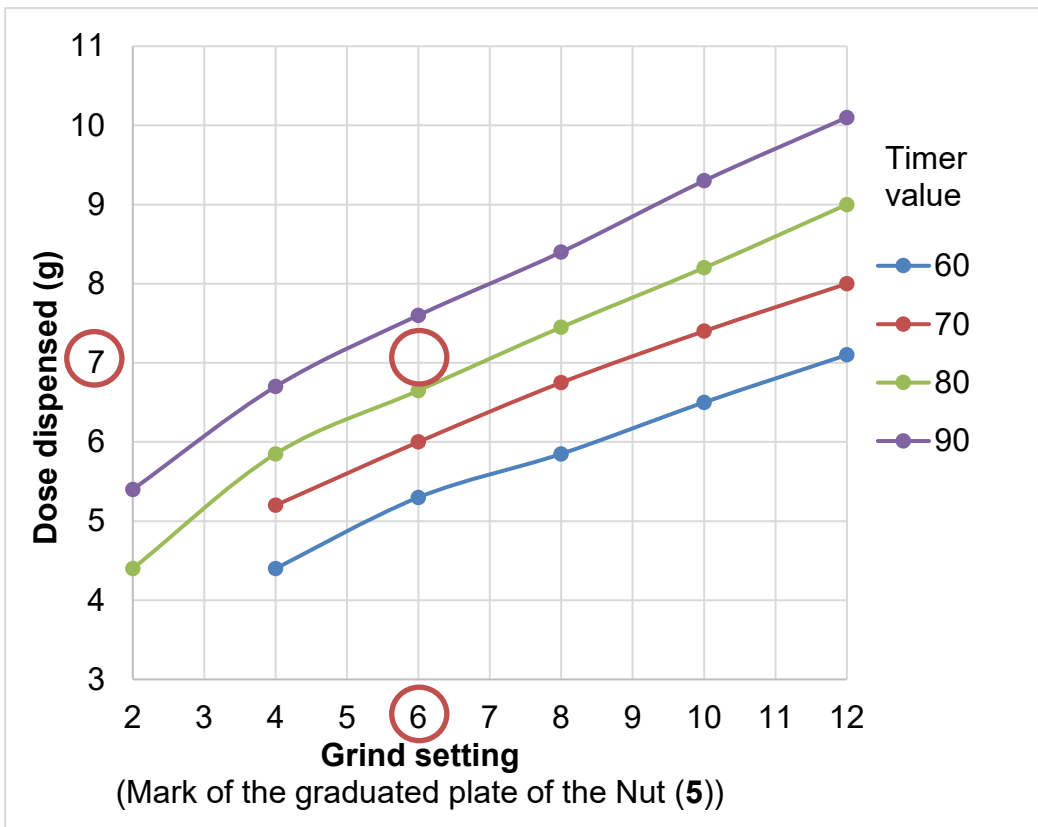

Table explanation:
 For example: you have set your grind and this corresponds to "notch 6" on the grind setting nut (5). If you want to obtain 7g for a dose of coffee then you must set the timer value between 080 and 090 for an espresso coffee.

Indicative values for one dose and for new SANTOS burrs

The settings for the 2 selection buttons (20) and (21) are independent (fig. D).

Single dose setting:

1. Enter the settings menu (see the "General operations of screen settings" part)
2. Select "Dose setting"
3. Select "Single dose"
4. Adjust the dose
 - Pressing selection button 1 (20), increases the value by one unit (0.01 seconds)

- Pressing selection button 2 (**21**), increases the value by one unit (0.01 seconds)
5. Pressing the "P" selection button **22**, confirms the value displayed
 6. Go back to the main screen (see the "**General operations of screen settings**" part)

Double dose setting:

1. Enter the settings menu (see the "**General operations of screen settings**" part)
2. Select "Dose setting"
3. Select "Double dose"
4. Adjust the dose
 - Pressing selection button 1 (**20**), increases the value by one unit (0.01 seconds)
 - Pressing selection button 2 (**21**), increases the value by one unit (0.01 seconds)
5. Pressing the "P" selection button **22**, confirms the value displayed
6. Go back to the main screen (see the "**General operations of screen settings**" part)

Timer settings range

For "1 coffee": from 40 to 1,000

For "2 coffees": from 40 to 1,000

The appliance is factory set. At any time, you can reset to factory settings.

Resetting to factory settings

1. Enter the settings menu (see the "**General operations of screen settings**" part)
2. Select "Dose setting"
3. Select "Factory setting"
4. Place the cursor on "Yes"
5. Press the "P" selection button (**22**) to confirm
6. Go back to the main screen (see the "**General operations of screen settings**" part)

GENERAL OPERATIONS OF SCREEN SETTINGS

To enter the settings menu:

- Simultaneously press selection buttons 1 and 2 (**20** and **21**) until the menu is displayed.

To browse through the settings menus, use selection buttons (**20**, **21** and **22**) associated with the pictogram displayed on the screen:

- "∧" to go upwards in the list,
- "∨" to go downwards in the list,
- "+" to increase the value
- "-" to decrease the value
- "OK" to confirm

To exit the settings menu and go back to the main screen:

- Press "Back" until the main screen is displayed, or

- Simultaneously press selection buttons 1 and 2 (**20** and **21**), or
- Do not press any button for 30 seconds

Note: The motor is deactivated when the menu is activated.

CUSTOMISING THE MAIN SCREEN

Display or hide the Total counter on the main screen

1. Enter the settings menu (see the "General operations of screen settings" part)
2. Select "Display settings"
3. Select "Dose counters"
4. Select "Total"
5. Place the cursor under "Yes" to display it or under "No" to hide it
6. Press the "P" selection button (**22**) to confirm
7. Go back to the main screen (see the "General operations of screen settings" part)

It is possible to display both counters on the main screen (total and partial)

Display or hide the Partial counter on the main screen

1. Enter the settings menu (see the "General operations of screen settings" part)
2. Select "Display settings"
3. Select "Dose counters"
4. Select "Partial"
5. Place the cursor under "Yes" to display it or under "No" to hide it
6. Press the "P" selection button (**22**) to confirm
7. Go back to the main screen (see the "General operations of screen settings" part)

It is possible to display both counters on the main screen (total and partial)

Adjust screen brightness

1. Enter the settings menu (see the "General operations of screen settings" part)
2. Select "Display settings"
3. Select "Brightness"
4. Adjust the brightness
 - Pressing selection button 1 (**20**), decreases the value by 5 units (minimum value: 5%)
 - Pressing selection button 2 (**21**), increases the value by 5 units (maximum value: 100%)
5. Press the "P" selection button (**22**) to confirm
6. Go back to the main screen (see the "General operations of screen settings" part)

Change the language

1. Enter the settings menu (see the "General operations of screen settings" part)
2. Select "Display settings"
3. Select "Language"
4. Select the desired language
5. Go back to the main screen (see the "General operations of screen settings" part)

part)

INFORMATION CONCERNING THE COFFEE GRINDER

View the Total counter

1. Enter the settings menu (see the "General operations of screen settings" part)
2. Select "Statistics"
3. Select "Total counter"
4. Press the "P" selection button (**22**) to exit
5. Go back to the main screen (see the "General operations of screen settings" part)

View the Partial counter

1. Enter the settings menu (see the "General operations of screen settings" part)
2. Select "Statistics"
3. Select "Partial counter"
4. Press the "P" selection button (**22**) to exit
5. Go back to the main screen (see the "General operations of screen settings" part)

Reset the partial counter

1. Enter the settings menu (see the "General operations of screen settings" part)
2. Select "Statistics"
3. Select "Reset the partial counter"
4. Select "Reset"
5. Place the cursor on "Yes"
6. Press the "P" selection button (**22**) to confirm
7. Go back to the main screen (see the "General operations of screen settings" part)

The Total counter cannot be reset

View the software version

1. Enter the settings menu (see the "General operations of screen settings" part)
2. Select "Technical data"
3. Select "Software version"
4. Press the "P" selection button (**22**) to exit
5. Go back to the main screen (see the "General operations of screen settings" part)

"PULSE" FUNCTION

The "Pulse" function delivers a customised dose of coffee. This dose cannot exceed a duration of 10 seconds.

The "Pulse" function can be configured in the settings of the appliance. The latter can be used via the portafilter Microswitch (25) or via the "P" selection button (22)

Operation via the portafilter Microswitch (25): (Portafilter mode)

1. Select the "pulse" mode by pressing the "P" selection button (22)
2. Press the portafilter Microswitch (25) using the portafilter to deliver the dose

In this mode, as long as the portafilter is pressing on the portafilter Microswitch (25), the appliance delivers coffee.

Operation via the "P" selection button (22): (Button mode)

1. Place the portafilter on the fork in position, ready to receive the dose
2. Press the "P" selection button (22)

In this mode, as long as the "P" selection button (22) is pressed, the appliance delivers coffee.

Setting the "Pulse" function

1. Enter the settings menu (see the "General operations of screen settings" part)
2. Select "Dose setting"
3. Select "Pulse mode management"
4. Select "With portafilter or button"
5. Place the cursor on the desired mode (see explanations hereinabove)
6. Press the "P" selection button (22) to confirm
7. Go back to the main screen (see the "General operations of screen settings" part)

BURRS WEAR INDICATOR

This appliance has a system that makes it possible to know the state of burr wear. This tool informs the user when the burrs have to be changed via a warning message on the screen (see the "Burr change warning" part).

View the burrs wear indicator

1. Enter the settings menu (see the "General operations of screen settings" part)
2. Select "Technical data"
3. Select "Burrs wear indicator"
 - 0%: new burrs
 - More than 100%: burrs in poor state (see the "Replacement of burrs" part)
4. Press the "P" selection button (22) to exit
5. Go back to the main screen (see the "General operations of screen settings" part)

Burr change warning

When the burrs wear indicator reaches 95%, a warning message is displayed on the screen to recommend changing the burrs.

Press the "P" selection button (22) to hide the message, go to the main menu and use the

coffee grinder.

The warning message is displayed for the next 10 start-ups of the appliance, except if a change in burrs set has been reported (see the "Report a burrs set change" part)

Report a burrs change

The "report a burrs set change" tool makes it possible to track the number of burrs sets that have been replaced since the appliance was put into service.

Using this tool when changing the burrs set makes it possible to:

- Increase the counter for the number of burrs sets replaced by one,
- To reset the burrs wear indicator.

In order for the tracking to be correct, use this tool only when the burrs of the appliance have just been changed.

To report a change in the burrs set:

1. Enter the settings menu (see the "General operations of screen settings" part)
2. Select "Technical data"
3. Select "Report a burrs change"
4. Select "Have you changed your burrs?"
5. Place the cursor on "Yes"
6. Press the "P" selection button (22) to confirm
7. Go back to the main screen (see the "General operations of screen settings" part)

View the number of burrs sets replaced

1. Enter the settings menu (see the "General operations of screen settings" part)
2. Select "Technical data"
3. Select "Number of burrs sets replaced"
4. Press the "P" selection button (22) to exit
5. Go back to the main screen (see the "General operations of screen settings" part)

MAIN SCREEN STANDBY MODE

Putting the screen into standby mode saves power. The standby screen continues to display the last mode used (yellow cursor) and the SANTOS logo, and decreases screen brightness.

When the screen is in standby mode, the appliance remains active and ready to use.

Simply pressing the portafilter Microswitch (25) goes back to the main screen and distributes the dose of coffee for the last mode selected.

When the screen is in standby mode, pressing one of the selection buttons (20, 21 or 22) goes back to the main screen and activates the selected mode.

Changing the time before screen standby

1. Enter the settings menu (see the "General operations of screen settings" part)
2. Select "Display settings"
3. Select "Standby time"

4. Adjust the time
 - Pressing selection button 1 (**20**), increases the value by one unit (minimum value: 1 min)
 - Pressing selection button 2 (**21**), increases the value by one unit (maximum value: 20 min)
5. Press the "P" selection button (**22**) to confirm
6. Go back to the main screen (see the "**General operations of screen settings**" part)

CLEANING:



IMPORTANT:

- In all cases, stop the appliance and unplug its power cord (**10**).
- The appliance must not be cleaned with a water jet or water under pressure.
- Clean the coffee outlet area regularly, but make sure nothing gets into the conduit (**23**)

SERVICING

Before working on the appliance, it is essential to disconnect it from the mains and discharge the motor starting capacitor.

Discharging the capacitor:



- Unscrew the 2 screws located under the appliance in the middle of the bottom metal plate (fig. E).
- Take out the electronic component unit (**26**) from the bottom metal plate.
- Using a screwdriver with an **insulated handle**, touch the 2 connections of the capacitor (**14**). A visible electric arc proves the discharge of the capacitor.

Spare parts:

This machine does not require any particular maintenance. The bearings are lubricated for life.

If it is necessary to replace wear parts such as burrs, electrical components or other parts, refer to the parts list (see exploded view at the end of this manual).

When **ordering spare parts** (for part numbers see the exploded view at the end of this manual), specify:

- **the type,**
- **the serial number of the appliance and**
- **the electrical specifications (**16**)**

marked on the bottom of the appliance.

Prolonged non-use:

This appliance has no restrictions to prolonged inactivity.

We simply recommend cleaning it before use and checking the condition of the components of the appliance (e.g. power cord, seals and other spare parts). If the appliance will not be

used for more than 1 month, it is recommended to vacuum out any coffee residue in the grinding body in order to prevent the risk of fouling by clumping and hardening.

Replacing burrs:



IMPORTANT: always replace the 2 burrs (9) at the same time.

Use SANTOS burrs:

Refer to the table of the appliance's specifications to order the reference for the burrs set that corresponds to your appliance.

The 2 burrs are identical and can be mounted on the movable plate (8) (movable burr) or on the adjustment nut (5) (fixed burr). (fig. F).

1. Close the shutter of the bean hopper (6) (fig. G).
2. Turn on the appliance until the coffee beans in the grinding body have passed.
3. Turn off the appliance and disconnect the power cord (10).
4. Remove the bean hopper (2).
5. Unscrew only the screw on the nut tab and remove the nut tab (27) (fig. P)
6. With one hand, press the **indexing pin (7)** and with the other unscrew the adjustment nut by turning it anti-clockwise (fig. I).

Caution: When it is completely unscrewed, handle this part carefully so as to avoid damaging the brass threading.

7. Unscrew the 3 screws from each burr (fig. J). To lock the rotation of the burr support plate when unscrewing or screwing the fastening screws of the movable burr, place a non-aggressive screwdriver between the grinding body and one of the fins of the plate.



CAUTION: Do not insert the screwdriver into the orifice of the coffee outlet conduit. This would destroy the anti-static tab and interfere with the proper functioning of the appliance.

8. Perfectly clean the entire grinding body and in particular the burr supports.
9. Place each burr on its support, making sure that there is no coffee dust between the burr and its support.



CAUTION: The slightest small coffee particle placed under the burr can interfere with the proper operation of the appliance. We recommend cleaning the grinding body assembly with a compressed air jet or a dry brush.

CAUTION: Do not unscrew the fastening shaft (17) from the burr support plate (8) in order to avoid damaging the geometry of the whole (fig. K).

10. Once the 2 burrs have been replaced, with one hand, press on the indexing pin (7) and with your other hand, place the grind setting nut (5) on the grinding body making sure not to damage the threading. Without the use of force, place the "nut" (5) on the grinding body by gently unscrewing so as to feel the correspondence of the two threads and as such be able to start them, **without the use of force**. Then screw

until the 2 burrs come into contact (fig. L).

11. Unscrew the "adjustment nut" (5) about ten notches to release the burrs that are in contact.
12. Connect the appliance and turn it on **without coffee**.
13. Use one hand to press the indexing pin, and with the other hand, screw the "adjustment nut" (5) until the 2 burrs come **slightly** into contact (slight noise).
14. Turn off the appliance.
15. Unscrew the 3 remaining fastening screws on the graduated plate (12) and re-index the "0" of the graduated plate with the indexing pin (7) (fig. M).
16. Unscrew the "adjustment nut" (5) from 5 to 10 notches.
17. With coffee, adjust the grind (see the "**Setting the grind**" part).
18. Then adjust the timers if the new burrs have modified the flow of the appliance (see the "**Adjusting the dose of ground coffee**" part).
19. Screw the nut tab (27) back, opposite the indexing pin (7) (fig.P.)

TROUBLESHOOTING ASSISTANCE

It is necessary to identify what has caused the appliance to stop working. In any case, if the problem persists, switch off (unplug the power cord (10)) and call in maintenance service or contact an approved SANTOS dealer.

If necessary, remember to close the shutter (6) of the bean hopper before removing the hopper.

The appliance does not start:

- Check that the On/Off switch light (11) lights up when the latter is in the "1" position. Otherwise, check the following 2 points, then replace the switch.
- Check that the overcurrent protector has not been triggered after an overload. (see the paragraph "**The appliance stops following a motor overload** ")
- Check: the mains supply, the condition of the power cord (10).
- Check that the display (19) lights up. Otherwise, replace the "control" part of the electronic module. If the display (19) still does not turn on, then change the electronic ribbon cable.
- Check that one of the 3 buttons is selected. (Press a selection button (20, 21 or 22), the yellow cursor must be displayed on the screen above the latter).
- Check that the burrs (9) are not in contact and prevent the motor from starting.
- Check that there are no foreign objects caught between the burrs.
- Inside the appliance: check the condition of the electrical wires and the connections (at the switch (11), at the component support module (26) (fig. N) (access to the electronic components without dismantling the appliance) and at the control panel (19), at the portafilter microswitch (25).
- Check the electrical components by replacing them one after the other.

The appliance stops because the motor has overheated: (the motor unit is hot)

(220V version)

The motor is protected by a built-in thermal protector. The appliance stops if the motor

overheats.

- Check that there are still coffee beans in the bean hopper (2).
- Move the On/Off switch (11) to the "0" position, unplug the mains plug.
- Wait for the motor to cool down (20 to 45 minutes), then flip the On/Off switch (11) (position "1").

The appliance stops following an overload:

Motor overload can be caused by a foreign body between the burrs, the burrs in contact, an excessively fine grind.

In these conditions, either the thermal protector or the overcurrent protector can be activated and stop appliance operation.

If the appliance is hot, then see the "The appliance stops because the motor has overheated" part.

Otherwise:

- Turn off the appliance (unplug the mains plug (10))
- Flip the on/off switch (11) to the "0" position.
- Under the appliance (fig.O), push the button (13) to reset the overcurrent protector. If the button does not remain in the "reset" position, allow the appliance to cool before renewing the operation.

If the problem persists, switch off the power (unplug the mains plug (10)) and call in maintenance service or contact a Santos authorized dealer.

The dose of ground coffee is not even

- Check that there are coffee beans in the bean hopper. We recommend having at least 400g of coffee beans in the hopper.
- Clean the ground coffee outlet conduit (23). (fig. H)

The appliance runs without filling the portafilter

- Check that there are coffee beans in the bean hopper.
- Check that the bean hopper shutter (6) is in the open position.
- Try to set a coarser grind
- Replace the burrs (9).

Espresso coffees tend to be increasingly lighter

- Check and adjust the grind setting then
- Check and adjust the timer settings. (the values of the timers increase according to the wear of the burrs. If the values are too high, then replace the burrs (9).

The "Pulse" function stops although the button is still pressed

- The "Pulse" function can operate for a maximum of 10 seconds.
- Press the button again to deliver another customised dose.

TECHNICAL SPECIFICATIONS OF THE APPLIANCE

TECHNICAL SPECIFICATIONS

Model 59		59	59V4	59V1
Power voltage	(V)	220-240	220-240	100-120
Frequency	(Hz)	50	60	60
Single-phase Motor: Power				
Absorbed power	(W)	1100	1100	750
Speed	(rpm)	2850	3400	
Diameter of the burrs	(mm)	63.5	63.5	63.5
SANTOS burr reference		00001B	00001	00001
Bean hopper capacity	(kg)	1.2		
Average flow	(Kg/h)	25		
timer setting no. 1		40 to 1,000		
timer setting no. 2		40 to 1,000		
Dose setting (approx.)	(g)	From 5.5 to 50		
The appliance is not intended for continuous operation		10 seconds on and 20 seconds off		
Dimensions: Height	(mm)	540		
Width	(mm)	198		
Depth	(mm)	352		
Weight: Net weight	(kg)	14.8		
Shipping weight	(kg)	16.8		
Noise level: (2)	(DBA)	63		

- (1) These values are given for information only. The exact electrical characteristics of your appliance are noted on its manufacturer's plate.
- (2) Noise level measured at sound pressure with appliance under load at 1 m from its axis according to EN 31201.

Electrical diagram 110-120V 60Hz and 220-240V 50/60Hz

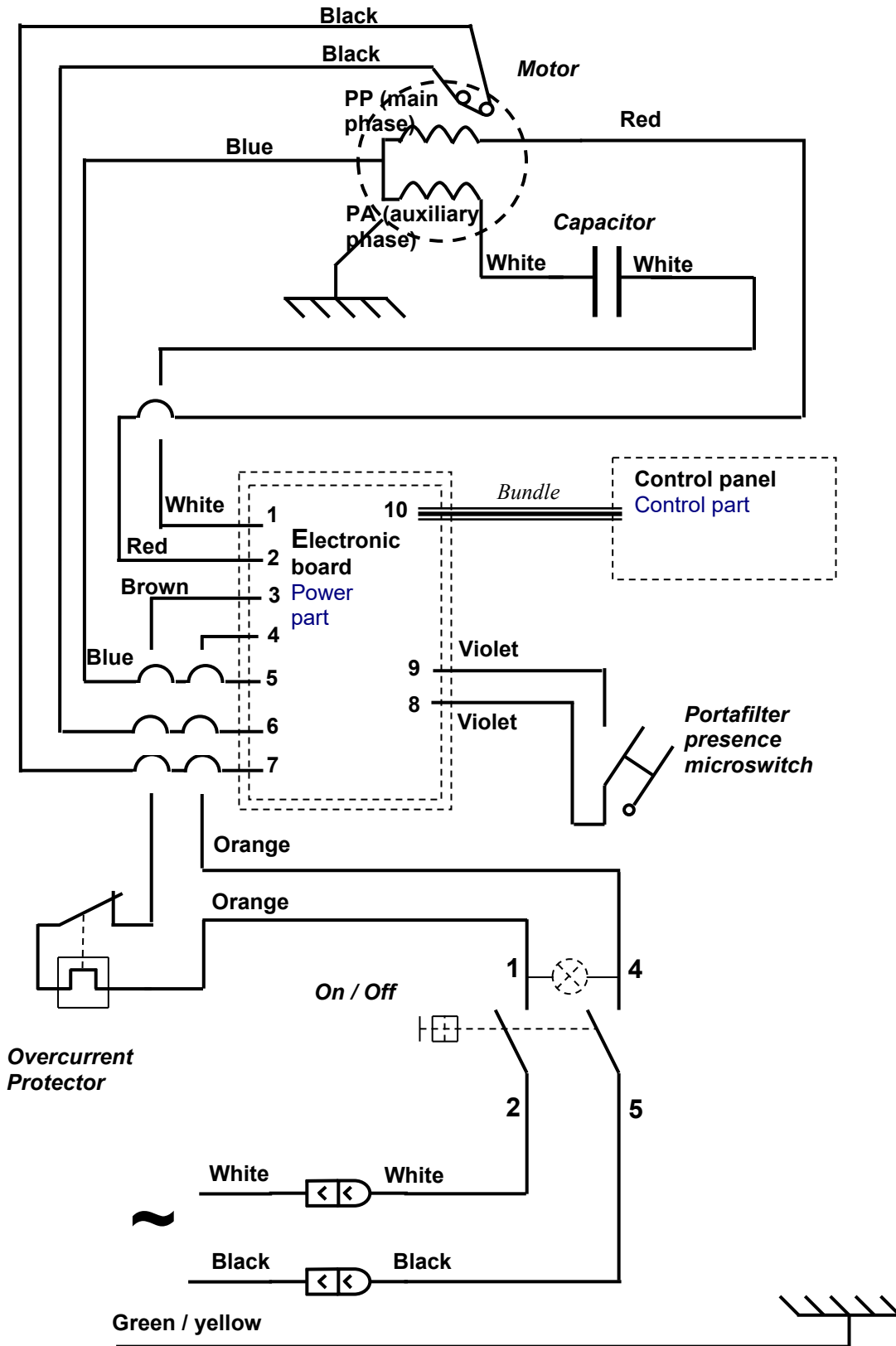

Correlation table

ITEM	Designation
1	Bean hopper cover
2	Bean hopper
3	Grind collector
4	Base plate
5	Grinding body
6	Bean hopper shutter
7	Indexing pin
8	Burr support plate
9	Burr
10	Power cord plug.
11	On/off switch
12	Graduated plate
13	Overcurrent protector
14	Capacitor
15	Ground coffee tamper
16	Manufacturer's plate
17	Motor shaft nut
18	Control panel
19	Lighted display
20	1 coffee selection button
21	2 coffees selection button
22	"P" selection button
23	Ground coffee outlet conduit
24	Portafilter fork
25	Portafilter microswitch
26	Electronic component unit
27	Nut tab

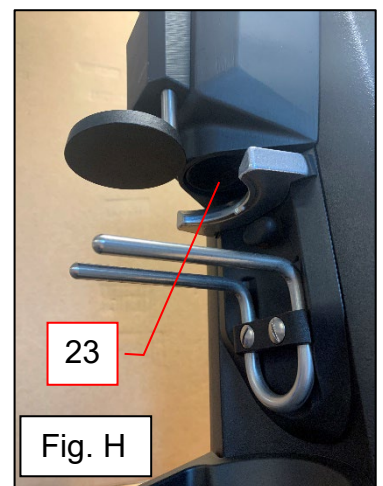
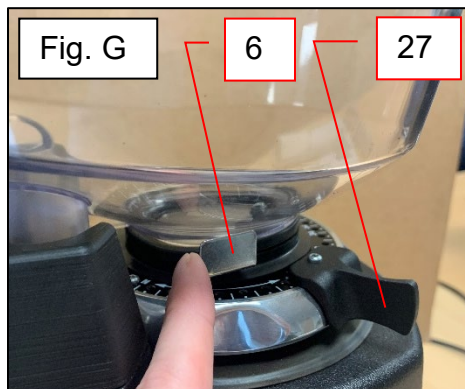
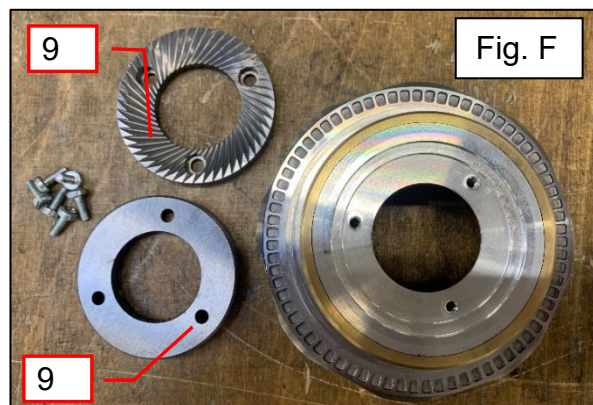
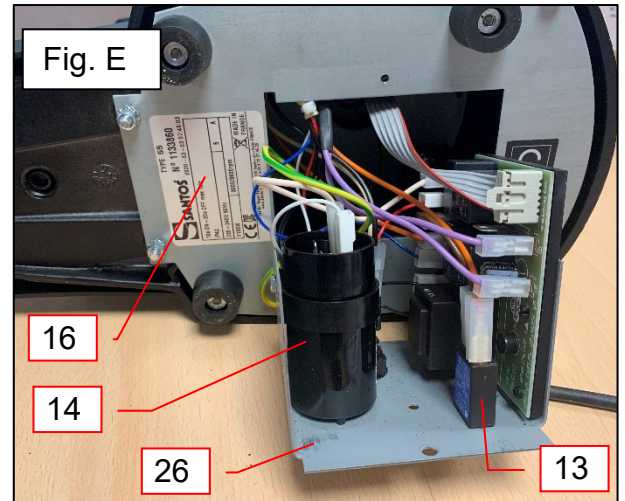
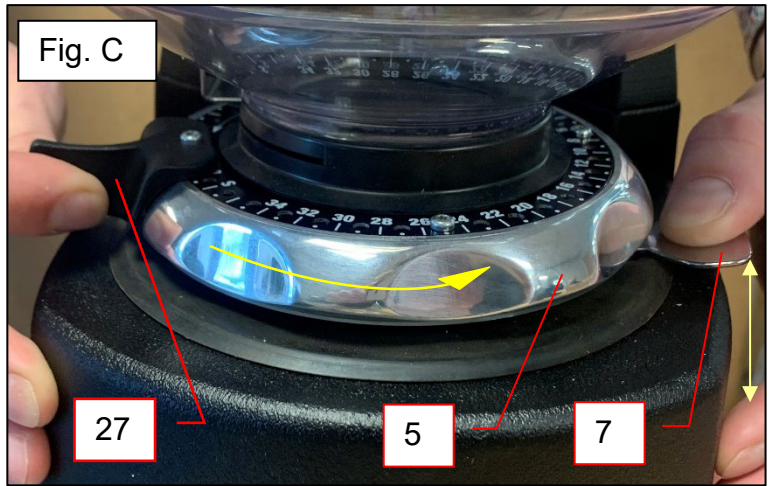
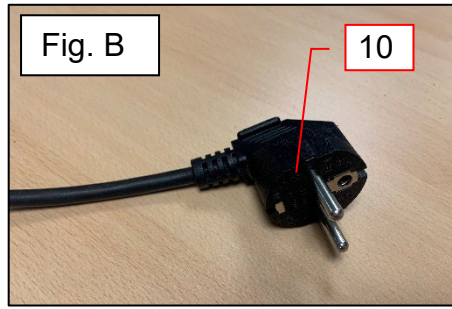

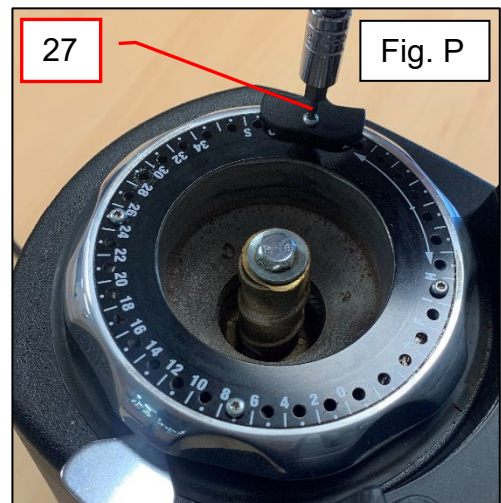
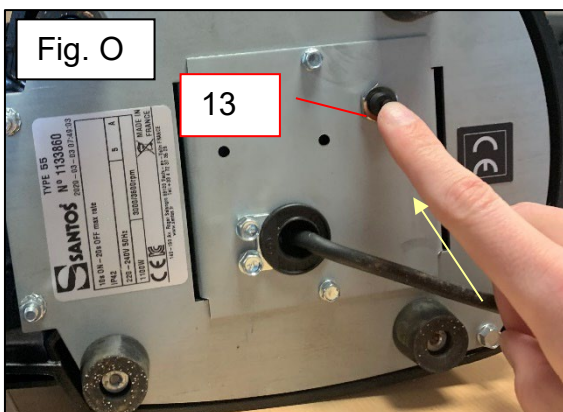
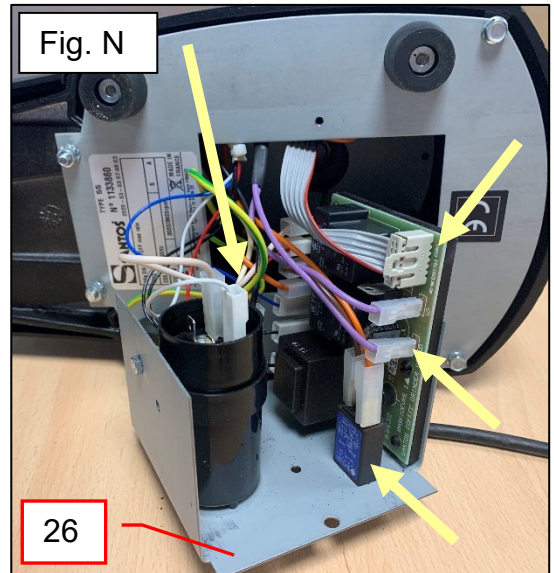
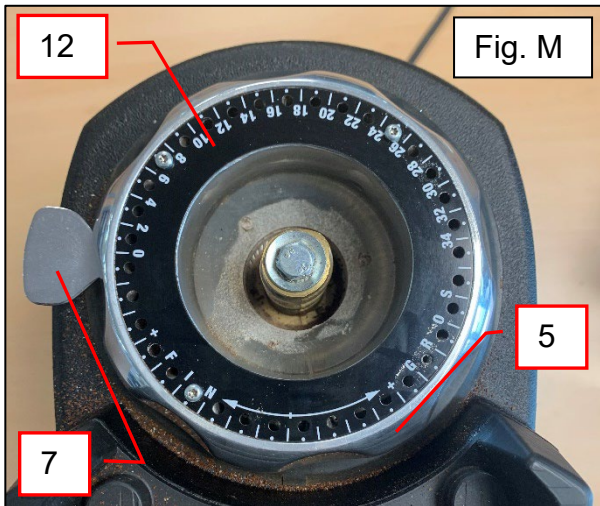
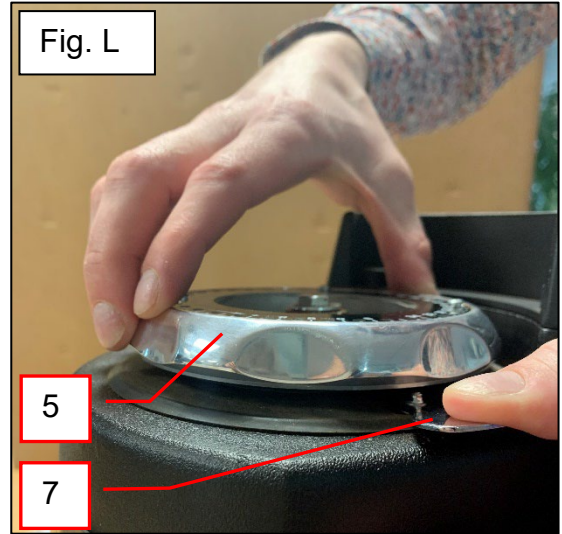
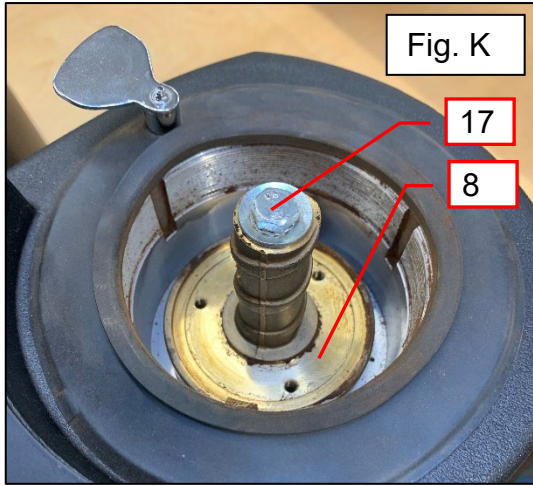
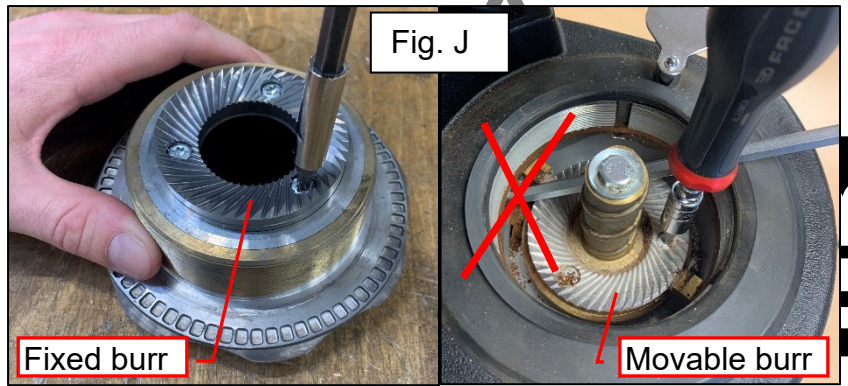
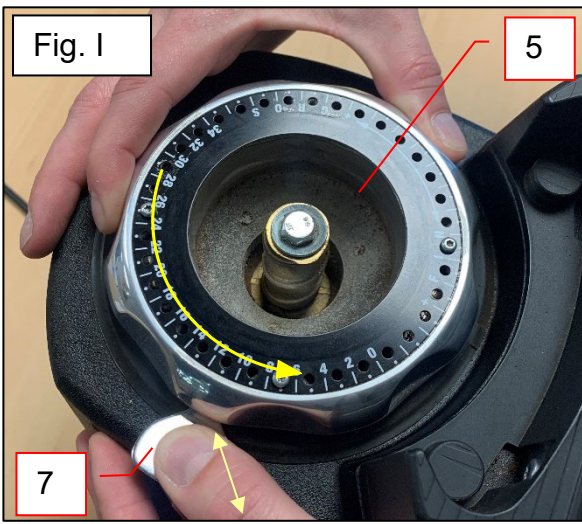

CERTIFICAT DE GARANTIE

GARANTIE

Depuis le 01.01.95, tous nos appareils **sont conformes CE et revêtus du label CE**. Notre garantie est de **vingt quatre mois** à partir de la date de fabrication figurant sur la plaque signalétique, sauf en ce qui concerne les moteurs asynchrones (composé d'un rotor et d'un stator) qui sont garantis pour une durée de 5 ans à compter de leur date de fabrication. La garantie est strictement limitée au remplacement gratuit de toute pièce d'origine reconnue par nous défectueuse à la suite d'un défaut ou d'un vice de construction et identifiée comme appartenant à l'appareil considéré. Elle ne s'applique pas aux avaries résultant d'une installation ou d'une utilisation non-conforme aux prescriptions accompagnant chaque appareil (manuel d'utilisation) ou dans le cas d'un manque évident d'entretien ou de non observation des règles élémentaires de sécurité électriques. La garantie ne s'applique pas en cas d'usure naturelle. Tout remplacement de pièce sous garantie est effectué après renvoi de la pièce défectueuse en nos ateliers en port payé, accompagnée d'une **copie de la Déclaration de conformité** sur laquelle figure le numéro de série de l'appareil. Tout appareil est muni d'une **plaque signalétique** conforme CE et dont un double figure dans la Déclaration de conformité (N° de série, date de fabrication, caractéristiques électriques...). En cas d'avarie grave jugée réparable uniquement dans nos ateliers, et **après accord préalable de nos services**, tout appareil sous garantie est expédié par le Distributeur en port payé. En cas de réparation ou reconditionnement d'appareil hors garantie, le transport aller-retour est à la charge du Distributeur. Les pièces et main-d'œuvre sont facturées aux tarifs en vigueur (tarif pièces détachées – tarif horaire – main-d'œuvre). Il peut être fourni un devis préalable.

Les moulins à café non munis de meules originales SANTOS ne sont pas pris sous garantie. Les conditions de garantie, réparation, reconditionnement, des moulins à café espresso font l'objet d'une notice spécifique. Notre garantie ne s'étend pas au paiement de pénalités, à la réparation des préjudices directs ou indirects et notamment à tout manque à gagner résultant de la non-conformité ou défectuosité des produits, la responsabilité globale de SANTOS étant limitée au prix de vente du produit livré et à l'éventuelle réparation des produits défectueux.

En cas de révélation d'une défectuosité pendant la période de garantie, le Distributeur doit, sauf accord contraire écrit de SANTOS, indiquer à son client, de cesser toute utilisation du produit défectueux. Une telle utilisation dégagerait SANTOS de toute responsabilité.

PLAQUE SIGNALÉTIQUE DE L'APPAREIL

