



HOSHIZAKI

IM-240APE

Cuber, Modular

Production Capacity (kg/24h) approx. (AT 10°C, WT 10°C): 210



PRODUCT SERIES: IM CUBE

ITEM NUMBER: M119

COUNTRY OF ORIGIN: UK

Hoshizaki IM-240APE Cube model is a modular ice maker producing up to 210 kg of cube ice per 24 hours. This model is compatible with our storage bins.

Ice cube dimensions and weight - disclaimer: The drawing is for illustration purposes only. Cube size and weight may differ due to local installation conditions.

- Ice making system with an automatic rinse cycle
- Each ice cycle is made with fresh water
- Closed water circuit for contamination protection
- Closed Cell System helps produce compact, hard and geometrically perfect ice
- Easy external access to control panel
- System comes with a magnetic DC water pump with variable speed and that has no direct coupling, which prevents any leakage
- UV-C sanitization function is retrofittable
- Cleanable air filter
- Stainless steel frame inside
- Easily removable water pan assembly

ICE TYPE: Large cubes, Standard

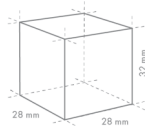

Cube Size: **STANDARD**
Weight: 23 g

WARRANTY PERIOD

3 Years on Parts & Labour - based on country agreement

EXTERIOR

Stainless steel AISI 430, Galvanized steel (Rear)

Refrigerant: R290 / Refrigerant (kg): 0.147 / CO2 equivalent (kg): 0.441

OPERATING CONDITIONS

Ambient Temp.: 1-40°C, Water Supply Temp.: 5-35°C, Water Supply Pressure: 0.07-0.8MPa (0.7-8bar), Voltage Range: Rated Voltage ±6%

ACCESSORIES INCLUDED

Scoop, installation kit, ice chute

OPTIONAL ACCESSORIES

4HC-H water filtration, UV-C sanitization kit

CORRESPONDING WATER FILTERS

4HC-H Twin Water Filter, 4HC Replacement Cartridge

CORRESPONDING BIN(S)

B-140SA, B-210SA, B-340SA

CORRESPONDING TOP KITS

TK-30 for B-140SA, B-210SA, B340SA (optional, not required), TK-8D for B-210SA, TK-8D + TK18D for B-340SA

CERTIFICATIONS





HOSHIZAKI

IM-240APE

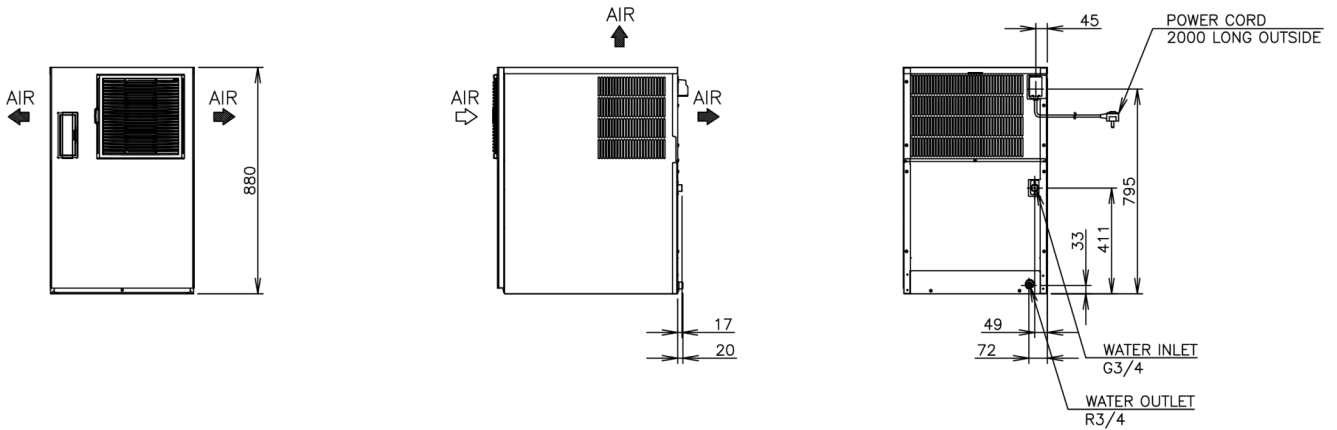
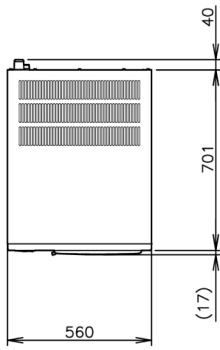

TECHNICAL SPECIFICATIONS

Cooling System	Production Capacity (kg/24h) approx. (AT 10°C, WT 10°C)	Production Capacity (kg/24h) approx. (AT 21°C WT 15°C)	Production Capacity (kg/24h) approx. (AT 32°C WT 21°C)	Power Supply	Electrical Circuit Breaker Protection (A)	Electric Consumption (kW)	Water Consumption (m ³ /24h) approx. (AT 10°C WT 10°C)	Heat Rejection (AT 32°C, WT 21°C) (kW)
Air Cooled	210	195	175	1/220 - 240V/50Hz	5	0.85	0.67	2.51

SHIPPING SPECIFICATIONS

Dimensions W x D x H (mm)	Net Weight (kg)	Dimensions, Packed, W x D x H (mm)	Gross Weight, Packed (kg)	Volume Packed (m ³)
560 x 700 x 880	78	665 x 820 x 1054	89	0.575

Disclaimer: Every effort has been made to ensure that the information contained in this spec sheet is accurate at the time of publishing. Hoshizaki Europe BV assumes no responsibility or liability for typographical errors or omissions or for any misinterpretation of the information within the publication and reserves the right to change without notice.

Please observe: Water cooled units should have the condenser circuit connected to a self-contained recirculating system. It is likely that the connection of such units to the mains water supply may be a contravention of local water authority by-laws.



Hoshizaki Belgium
 Hoshizaki Danmark
 Hoshizaki Deutschland
 Hoshizaki France
 Hoshizaki Iberia
 Hoshizaki Italia
 Hoshizaki Middle East

info@hoshizaki.be
info@hoshizaki.dk
vertrieb@hoshizaki.de
info@hoshizaki.fr
info@hoshizaki.es
commerciale@hoshizaki.it
sales.ex@hoshizaki-europe.com

Hoshizaki Netherlands info@hoshizaki.nl
 Hoshizaki Norge salg@hoshizaki.no
 Hoshizaki Sverige orderSE@hoshizaki.dk
 Hoshizaki UK uksales@hoshizaki.uk
 Export countries sales.ex@hoshizaki-europe.com
 Other countries sales.ex@hoshizaki-europe.com

www.hoshizaki-europe.com