



# A WORLD INSIDE THE KITCHEN

**2017**

CATÁLOGO / CATALOGUE  
CATALOGUE / KATALOG

**pujadas®**

A VOLLRATH® COMPANY

PROFESSIONAL COOKWARE





**pujadas**<sup>®</sup>

A VOLLRATH<sup>®</sup> COMPANY

**PROFESSIONAL COOKWARE**

Ctra. de Castanyet, 132 - P.O.Box 121  
17430 Santa Coloma de Farners  
(GIRONA) - SPAIN

**Ventas en España**

Tel. 972 84 32 01  
Fax 972 84 35 27  
info@pujadas.es

**Export Department**

Tel. +34 972 84 32 01  
Fax +34 972 84 35 27  
info@pujadas.es

**www.pujadas.es**  
info@pujadas.es

# ÍNDICE DE PRODUCTOS / PRODUCT INDEX / TABLE DES MATIÈRES / PRODUKTINDEX



# 1.

## COCINA / KITCHEN / CUISINE / KÜCHE

<b>1.1</b>	<b>BATERÍA DE COCINA / COOKWARE / BATTERIE DE CUISINE / KOCHEBEDARF</b>	<b>16</b>
<b>1.2</b>	<b>SARTENES / FRY PANS / POÊLES / PFANNEN</b>	<b>40</b>
<b>1.3</b>	<b>HORNO Y RUSTIDERAS / OVEN AND ROAST PAN / FOUR ET PLAQUES À RÔTIR / OFEN- UND BRATFORMEN</b>	<b>52</b>
<b>1.4</b>	<b>ACCESORIOS DE COCINA / KITCHEN ACCESSORIES / ACCESSOIRES DE CUISINE / KÜCHENZUBEHÖR</b>	<b>60</b>



# 2.

## BATERÍA COCINA FOODIES / FOODIES COOKWARE / BATTERIE CUISINE FOODIES / FOODIES KOCHBEDARF

<b>2.1</b>	<b>PUJADAS 1921</b>	<b>130</b>
<b>2.2</b>	<b>BLACK SERIES</b>	<b>132</b>
<b>2.3</b>	<b>MULTIMETAL</b>	<b>136</b>
<b>2.4</b>	<b>COOL • LINE</b>	<b>138</b>
<b>2.5</b>	<b>IDEA</b>	<b>142</b>
<b>2.6</b>	<b>HOBBY CHEF</b>	<b>144</b>
<b>2.7</b>	<b>APARTAMENTO</b>	<b>146</b>
<b>2.8</b>	<b>UTENSILIOS DE COCINA / KITCHEN UTENSILS / USTENSILES DE CUISINE / KÜCHENUTENSILIEN</b>	<b>147</b>



# 3.

## TRANSPORTE Y ALMACENAMIENTO / TRANSPORT AND STORAGE / TRANSPORT ET STOCKAGE / TRANSPORT UND LAGERUNG

<b>3.1</b>	<b>CUBETAS GASTRONORM / GASTRONORM CONTAINERS / BACS GASTRONORME / GASTRONORM BEHÄLTER</b>	<b>156</b>
<b>3.2</b>	<b>CESTAS PARA VAJILLA / DISHWASHER RACKS / CASIERS À VAISSELLE / SPÜLMASCHINENKÖRBE</b>	<b>180</b>
<b>3.3</b>	<b>CARROS / TROLLEYS / CHARIOTS / SERVIERWAGEN</b>	<b>204</b>
<b>3.4</b>	<b>ESTANTERÍAS / SHELVING / ÉTAGÈRES / REGALE</b>	<b>224</b>

<b>RECAMBIOS / SPARE PARTS / PIÈCES DE RECHANGE / ERSATZTEILE</b>	<b>376</b>
---	------------

<b>INDEX / INDEX / INDEX</b>	<b>387</b>
--------------------------------------	------------



# 4.

## MAQUINARIA / MACHINERY / MACHINES / MASCHINEN

<b>4.1</b>	<b>MANTECADORAS HELADO / ICE-CREAM MAKERS / TURBINES À GLACE / EISMASCHINEN</b>	<b>244</b>
<b>4.2</b>	<b>PROCESADOR ALIMENTOS / FOOD PROCESSORS / ROBOTS MULTIFONCTION / LEBENSMITTEL MASCHINEN</b>	<b>248</b>
<b>4.3</b>	<b>BRAZOS TRITURADORES / IMMERSION BLENDERS / MIXEURS / STABMIXER</b>	<b>253</b>
<b>4.4</b>	<b>BATIDORAS / BLENDERS / MIXEURS / MIXER</b>	<b>256</b>
<b>4.5</b>	<b>FREIDORAS / FRYERS / FRITEUSES / FRITEUSEN</b>	<b>269</b>
<b>4.6</b>	<b>TOSTADORAS / TOASTERS / TOASTEURS / TOASTER</b>	<b>271</b>
<b>4.7</b>	<b>GRILL DE CONTACTO Y PLANCHAS ELÉCTRICAS / CONTACT GRILL AND ELECTRIC GRIDDLES / GRILL DE CONTACT ET PLAQUES ÉLECTRIQUES / KONTAKTGRILL UND ELEKTRISCHE</b>	<b>275</b>
<b>4.8</b>	<b>HORNOS Y MICRO-ONDAS / OVENS &amp; MICRO-WAVES / FOURS ET MICRO-ONDES / OFEN UND MIKROWELLEN</b>	<b>280</b>
<b>4.9</b>	<b>MAQUINARIA PARA CHOCOLATE / MACHINES FOR CHOCOLATE / MACHINES POUR LE CHOCOLAT / MASCHINEN FÜR SCHOKOLADE</b>	<b>282</b>
<b>4.10</b>	<b>MAQUINARIA MANTENEDORA DE TEMPERATURA / MACHINERY FOR KEEPING TEMPERATURE / APPAREILS DE MAINIEN EN TEMPÉRATURE / WARMHALTEMASCHINEN</b>	<b>285</b>



# 5.

## CATERING E INSTITUCIÓN / CATERING AND INSTITUTION / CATERING ET COLLECTIVITÉS / CATERING UND INSTITUTION

<b>5.1</b>	<b>MELAMINA / MELAMINE / MÉLAMINE / MELAMIN</b>	<b>294</b>
<b>5.2</b>	<b>COLECTIVIDADES / INSTITUTIONS / COLLECTIVITÉS / KOLLEKTIVITÄT</b>	<b>318</b>
<b>5.3</b>	<b>ALFOMBRAS CAUCHO / NATURAL RUBBER MATS / TAPIS EN CAOUTCHOUC / KAUTSCHUKMATTEN</b>	<b>323</b>
<b>5.4</b>	<b>SEÑALIZACIÓN / SIGNS / SIGNALISATION / MARKIERUNG</b>	<b>324</b>



# 6.

## HELADERÍA Y PASTELERÍA / ICE-CREAM UTENSILS & PASTRY / USTENSILES À GLACE ET PÂTISSERIE / ZUBEHÖR FÜR EISCREME UND PATISSERIE

<b>6.1</b>	<b>HELADERÍA / ICE-CREAM UTENSILS / USTENSILES POUR GLACE / ZUBEHÖR FÜR EISCREME</b>	<b>330</b>
<b>6.2</b>	<b>UTENSILIOS DE PASTELERÍA / PASTRY UTENSILS / USTENSILES DE PÂTISSERIE / PATISSERIEZUBEHÖR</b>	<b>336</b>
<b>6.3</b>	<b>MOLDES ANTIADHERENTES / NON-STICK MOULDS / MOULES ANTI-ADHÉSIFS / ANTIHAFT BACKFORMEN</b>	<b>348</b>
<b>6.4</b>	<b>CORTAPASTAS / PASTRY CUTTER / DÉCOUPOIRS / TEIGSCHNEIDER</b>	<b>352</b>
<b>6.5</b>	<b>MOLDES ACERO INOXIDABLE / ST/STEEL PASTRY MOULDS / MOULES EN ACIER INOX / BACKFORMEN ROSTF. STAHL</b>	<b>353</b>
<b>6.6</b>	<b>MANGAS Y BOQUILLAS / BAGS AND TUBES / POCHES ET DOUILLES / SPRITZBEUTEL UND TÜLLEN</b>	<b>357</b>
<b>6.7</b>	<b>MOLDES SILICONA / SILICONE MOULDS / MOULES SILICONE / SILIKONBACKFORMEN</b>	<b>362</b>
<b>6.8</b>	<b>MOLDES FLEXIPAN / FLEXIPAN MOULDS / MOULES FLEXIPAN / FLEXIPANBACKFORMEN</b>	<b>368</b>

**TODOS ESTOS  
PRODUCTOS AHORA  
SON VOLLRATH/**

**ALL THESE PRODUCTS  
ARE NOW VOLLRATH**

**TOUS CES PRODUIT  
SONT ACTUELLEMENT  
VOLLRATH/**

**ALLE DIESE PRODUKTE  
SIND JETZT VOLLRATH/**



Baño maría /  
Bain marie /  
Bain-marie /  
Wasserbad

P. 76



Dispensador /  
Dispenser /  
Distributeur /  
Spender

P. 93

## CUBIC®



Descubre la mejor presentación de buffet /  
Discover the best buffet display /  
Découvrez la meilleure présentation buffet /  
Entdecken sie die beste buffet-präsentation

P. 32-57



Baño maría /  
Bain marie /  
Bain-marie /  
Wasserbad

P. 75



Bandejas presentación /  
Serving trays /  
Plateaux de service /  
Serviertablets

P. 108 - 109



Olla eléctrica buffet /  
Soup kettle /  
Marmite buffet chaud /  
Elektrischer Buffettopf

P. 93



Chafing dishes

P. 87-88



Vitrinas / Display cabinets /  
Vitrines / Auslagevitrine

P. 60



Fuel para chafing dish /  
Chafing dish fuel barrel /  
Bidon fuel chafing dish /  
Brennstoff für chafing dish

P. 90



Pinza buffet /  
Utility tong /  
Pince buffet /  
Buffetzangen

P. 117 - 119





Aluminio fundición / Cast aluminium /  
Fonte d'aluminium / Aluminiumguss

Hierro fundido / Cast iron /  
Fonté émaillée / Gusseisen

18/10  
Inoxidable / St/Steel /  
Inoxydable / Edelstahl

.....

Miniaturas / Miniatures /  
Miniatures / Miniaturen

**P. 136-141**



.....

Bambú natural & madera /  
Natural bamboo & wood /  
Bambou naturel & bois /  
Naturbambus & holz

**P. 122-123**



.....

Utensilios buffet /  
Buffet utensils /  
Ustensiles buffet /  
Buffetutensilien

**P. 110-114**



.....

Bambú polipropileno /  
Polypropylene bamboo /  
Bambou polypropylène /  
Bambus polypropylen

**P. 124-125**



.....

Dispensador pan /  
Bread dispenser /  
Présentoir à pain /  
Brotbehälter

**P. 126**



.....

Pizarras /  
Slates /  
Ardoises /  
Schieferplatten

**P. 142-143**



.....

Manteles /  
Place mats /  
Sets de table /  
Platzmatten

**P. 134-135**



.....

Cesta /  
Basket /  
Corbeille /  
Korb

**P. 126-131**



.....

Complementos servicio de mesa / Table top service complements /  
Accessoires service de table / Tischservice zubehör

**P. 145-148**



.....

Servilletero /  
Napkin holder /  
Porte-serviettes /  
Serviettenspender

**P. 149**



.....

Portamenús /  
Menu holder /  
Porte-Menus /  
Menümappe

**P. 150**



**TECNOLOGÍA Y PASIÓN  
DENTRO DE LA COCINA/**

**TECHNOLOGY AND PASSION  
IN THE KITCHEN/**

**TECHNOLOGIE ET PASSION  
DANS LA CUISINE/**

**TECHNOLOGIE UND  
LEIDENSCHAFT  
IN DER KÜCHE**







**FABRICAMOS Y VENDEMOS UTENSILIOS DE COCINA. LOS VENDEMOS POR TODO EL MUNDO Y LO HACEMOS DESDE 1921. LA VERDAD ES QUE NO HEMOS DEJADO DE CRECER, MODERNIZARNOS E INTERNACIONALIZARNOS PERO ALGO QUE NO HA CAMBIADO, QUE SIGUE INTACTO DESDE EL PRIMER DÍA ES LA PASIÓN CON LA QUE TRABAJAMOS**

**WE MANUFACTURE AND SELL KITCHEN UTENSILS. WE SELL THEM ALL OVER THE WORLD AND HAVE BEEN DOING SO SINCE 1921. THE TRUTH IS THAT WE HAVE NEVER STOPPED GROWING, WE HAVE MODERNISED AND INTERNATIONALISED BUT WHAT HAS REMAINED INTACT SINCE THE VERY FIRST DAY IS THE PASSION WITH WHICH WE WORK**

**NOUS FABRIQUONS ET VENDONS DES USTENSILES DE CUISINE. NOUS LES VENDONS DANS LE MONDE ENTIER ET CELA DEPUIS 1921. IL EST VRAI QUE NOUS N'AVONS PAS CESSÉ DE GRANDIR, NOUS MODERNISER ET NOUS INTERNATIONALISER MAIS S'IL Y A UNE CHOSE QUI N'A PAS CHANGÉ, QUI RESTE INTACTE DEPUIS LE PREMIER JOUR, C'EST LA PASSION AVEC LAQUELLE NOUS TRAVAILLONS.**

**WIR PRODUZIEREN UND VERKAUFEN KÜCHENZUBEHÖR. WIR LIEFERN WELTWEIT UND DAS SCHON SEIT 1921. FAKT IST, DASS WIR NICHT AUFGEHÖRT HABEN ZU WACHSEN, UNS ZU MODERNISIEREN UND INTERNATIONAL ZU AGIEREN. DOCH EINE SACHE HAT SICH NICHT GEÄNDERT: DIE LEIDENSCHAFT, MIT DER WIR ARBEITEN, IST SEIT DEM ERSTEN TAG GLEICH GEBLIEBEN.**



**PASIÓN** POR INNOVAR Y SACAR NUEVAS PATENTES, PASIÓN POR CRECER, PASIÓN POR CONECTAR CON NUESTROS CLIENTES, ENTENDER SUS NECESIDADES E INCLUSO, SORPRENDERLES. PASIÓN POR APORTAR NUEVAS IDEAS A NUESTRA CATEGORÍA, PASIÓN POR EL DETALLE. UNA PASIÓN QUE SE CONVIERTE EN EL INGREDIENTE IMPRESCINDIBLE QUE NOS EMPUJA A SER UN POCO MEJORES CADA DÍA EN TODOS LOS ÁMBITOS DE LA COMPAÑÍA. Y JUNTO CON VOLLRATH NOS PERMITE ESTAR CERCA DE LOS MEJORES COCINEROS, EN SUS COCINAS Y EN SUS CASAS. PUJADAS DENTRO DE LA COCINA, Y VOLLRATH FUERA, CON SERVICIO Y BUFFET, TRABAJANDO EN COMPLICIDAD PARA AYUDAR A NUESTROS CLIENTES A CRECER Y CRECER CON ELLOS. QUEREMOS SEGUIR ACOMPAÑANDO A LOS AMANTES DE LA GASTRONOMÍA, PROFESIONALES Y FOODIES, CON NUESTRAS PIEZAS DE REFERENCIA.

**LARGA VIDA A LA BUENA COCINA!**

**PASSION** FOR INNOVATION AND FOR CREATING NEW PATENTS, PASSION FOR GROWTH, PASSION FOR CONNECTING WITH OUR CUSTOMERS, FOR UNDERSTANDING THEIR NEEDS AND EVEN FOR SURPRISING THEM. PASSION FOR BRINGING NEW IDEAS TO OUR SECTOR, PASSION FOR DETAIL. A PASSION THAT IS THE ESSENTIAL INGREDIENT THAT PUSHES US EVERY DAY TO BE A LITTLE BIT BETTER IN ALL AREAS OF THE COMPANY. AND TOGETHER WITH VOLLRATH, IT ALLOWS US TO BE CLOSE TO THE BEST CHEFS IN THEIR KITCHENS AND IN THEIR HOMES. PUJADAS WITHIN THE KITCHEN AND VOLLRATH OUTSIDE, WITH SERVICES AND BUFFETS, WORKING IN PARTNERSHIP TO HELP OUR CUSTOMERS TO GROW AND FOR US TO GROW WITH THEM. WE WANT TO CONTINUE ACCOMPANYING LOVERS OF FOOD, PROFESSIONALS AND FOODIES, WITH OUR BENCHMARK PRODUCTS.

**LONG LIVE GOOD COOKING!**

● **SOMOS FABRICANTES/  
WE ARE MANUFACTURERS/  
NOUS SOMMES FABRICANTS/  
WIR SIND HERSTELLER.**

● **ESTAMOS EN 90 PAÍSES  
DE TODO EL MUNDO/  
WE ARE IN 90 COUNTRIES  
THROUGHOUT THE WORLD/  
NOUS SOMMES DANS 90 PAYS  
AUX 4 COINS DU MONDE/  
WIR SIND IN 90 LÄNDERN  
WELTWEIT TÄTIG.**

● **SOMOS UNA COMPAÑÍA  
DEL GRUPO VOLLRATH/  
WE ARE A VOLLRATH  
GROUP COMPANY/  
NOUS SOMMES UNE SOCIÉTÉ  
DU GROUPE VOLLRATH/  
WIR SIND EIN UNTERNEHMEN  
DER VOLLRATH-GRUPPE.**

● **NUESTRA RECETA ESPECIAL  
ES EL TALENTO Y  
EL TRABAJO EN EQUIPO/  
OUR SPECIAL RECIPE  
IS TALENT AND  
TEAMWORK/  
NOTRE RECETTE SPÉCIALE  
C'EST LE TALENT ET  
LE TRAVAIL EN ÉQUIPE/  
UNSER SPEZIALREZEPT  
IST DAS TALENT UND  
DIE TEAMARBEIT.**







**NOTRE PASSION** C'EST L'INNOVATION, LA CRÉATION DE NOS PROPRES BREVETS, L'EXPANSION, NOTRE PASSION C'EST LE CONTACT AVEC NOS CLIENTS, LA COMPRÉHENSION DE LEURS BESOINS MAIS AUSSI LA VOLONTÉ DE LES SURPRENDRE. NOTRE PASSION C'EST LES NOUVELLES IDÉES DANS NOTRE SECTEUR, LE SOUCI DU DÉTAIL. CETTE PASSION DEVIENT L'INGRÉDIENT INDISPENSABLE QUI NOUS POUSSE À ÊTRE CHAQUE JOUR UN PEU MEILLEURS DANS TOUS LES DOMAINES DE L'ENTREPRISE. ET ÊTRE AUX CÔTÉS DE VOLLRATH NOUS PERMET D'ÊTRE PRÈS DES MEILLEURS CUISINIERS, DANS LEUR CUISINE ET CHEZ EUX. AVEC PUJADAS EN CUISINE ET VOLLRATH AU DEHORS, OFFRANT SERVICE ET BUFFET, NOUS TRAVAILLONS EN COLLABORATION POUR AIDER NOS CLIENTS À GRANDIR ET GRANDIR AVEC EUX. NOUS VOULONS RESTER AUX CÔTÉS DES PASSIONNÉS DE GASTRONOMIE, DES PROFESSIONNELS ET DES FOODIES, GRÂCE À NOS PIÈCES DE RÉFÉRENCE.

**LONGUE VIE À LA BONNE CUISINE !**

**DIE LEIDENSCHAFT**, INNOVATIV ZU SEIN UND NEUE PATENTE ANZUMELDEN. DIE LEIDENSCHAFT ZU WACHSEN. DIE LEIDENSCHAFT, NAH AM KUNDEN ZU SEIN, SEINE BEDÜRFNISSE ZU VERSTEHEN UND IHN SOGAR IN ERSTAUNEN ZU VERSETZEN. DIE LEIDENSCHAFT, NEUE IDEEN IN UNSERE BRANCHE EINZUBRINGEN. DIE LEIDENSCHAFT FÜR DETAILS. EINE LEIDENSCHAFT, DIE ZU EINEM UNENTBEHRLICHEN BESTANDTEIL WIRD, DER UNS DAZU ANTREIBT, JEDEN TAG IN ALLEN BEREICHEN DES UNTERNEHMENS EIN BISSCHEN BESSER ZU WERDEN. UND ZUSAMMEN MIT VOLLRATH SIND WIR IN DER LAGE, DEN BESTEN KÖCHEN NÄHER ZU KOMMEN, IN IHREN KÜCHEN UND IN IHREN HÄUSERN. PUJADAS INNERHALB DER KÜCHE UND VOLLRATH AUSSERHALB, IM SERVICE UND AM BUFFET, - DABEI SETZEN WIR AUF TEAMWORK, UM DAZU BEIZUTRAGEN, DASS UNSERE KUNDEN WACHSEN – UND WIR MIT IHNEN. UNSER WUNSCH IST ES, KOCHBEGEISTERTE, PROFIS UND FOODIES, MIT UNSEREN SPITZENPRODUKTEN ZU BEGLEITEN.

**FÜR EIN LANGES LEBEN DER GUTEN KÜCHE!**



# COCINA/ KITCHEN/CUISINE/KÜCHE

## 1.1 BATERÍA DE COCINA / COOKWARE / BATTERIE DE CUISINE / KOCHBEDARF 16

TOP LINE	18
INOX-PRO	24
HANDY	32
ALU-PRO	34

## 1.2 SARTENES / FRY PANS / POÊLES / PFANNEN 40

SARTENES ALUMINIO / ALUMINIUM FRY PANS / POÊLES ALUMINIUM / BRATPFANNEN ALUMINIUM	44
SARTENES ALUMINIO INDUCCIÓN / INDUCTION ALUMINIUM FRY PANS / POÊLES ALUMINIUM INDUCTION / INDUKTION BRATPFANNEN ALUMINIUM	46
SARTENES ACERO INOXIDABLE / ST/STEEL FRY PANS / POÊLES ACIER INOXYDABLE / BRATPFANNEN EDELSTAHL	47
SARTENES ACERO / STEEL FRY PANS / POÊLES ACIER / BRATPFANNEN ROSTFREIER STAHL	49
PAELLERAS / SPANISH PAELLA PAN / PLAT À PAELLA / PAELLAPFANNEN	50

## 1.3 HORNO Y RUSTIDERAS / OVEN AND ROAST PAN / FOUR ET PLAQUES À RÔTIR / OFEN- UND BRATFORMEN 52

RUSTIDERAS / ROAST PANS / PLAQUES À RÔTIR / BRÄTER	53
BANDEJAS GASTRONORM / GASTRONORM TRAYS / PLAQUES GASTRONORME / GASTRONOMTABLETS	54
BANDEJAS PASTELERÍA / PASTRY TRAYS / PLAQUES À PÂTISSERIE / PATISSERIETABLETT	54
REJILLAS / GRIDS / GRILLES / ROST	56
BANDEJAS PIZZERIA / PIZZERIA TRAYS / PLAQUES À PIZZERIA / PIZZABACKBLECHE	57
ACCESORIOS HORNO / OVEN ACCESSORIES / ACCESSOIRES FOUR / OFENACCESSORIES	58

## 1.4 ACCESORIOS DE COCINA / KITCHEN ACCESSORIES / ACCESSOIRES DE CUISINE/ KÜCHENZUBEHÖR 60

UTENSILIOS DE COCINA / KITCHEN UTENSILS / USTENSILES DE CUISINE / KÜCHENUTENSILIEN	60
PROCESADORES MANUALES DE ALIMENTOS / MANUAL FOOD PROCESSORS / APPAREILS MANUELS DE TRANSFORMATION DES ALIMENTS / HANDLICHEN SCHNEIDMASCHINEN GEEIGNET FÜR /	98
TABLAS DE CORTE / CUTTING BOARDS / PLANCHES À DÉCOUPER / SCHNEIDBRETTER	116
ELEMENTOS DE MEDIDA / MEASURING UTENSILS / USTENSILES DE MESURE / MESSUTENSILIEN	120
PROTECCIÓN TÉRMICA / HEAT PROTECTION / PROTECTION TÉRMIQUE / HITZESCHUTZ	124

PROFESIONAL / PROFESSIONAL /  
PROFESSIONNEL / PROFESSIONELL

FOODIES

TOP LINE

INOX-PRO

HANDY

ALU-PRO

PUJADAS 1921

REF /  
ITEM /  
CODE /  
ART.NR.



COMPATIBLE CON /  
COMPATIBLE WITH /  
COMPATIBLE AVEC /  
GEEIGNET FÜR



PRECIO /  
PRICE /  
PRIX /  
PREIS

€€€€

€€€€

€€

€

€€

GARANTÍA AÑOS /  
WARRANTY YEARS /  
GARANTIE ANNÉES /  
GARANTIE JAHRE

5

5

1

1

2

CERTIFICACIÓN /  
CERTIFICATION /  
CERTIFICATION /  
ZERTIFIKATION



ASAS /  
HANDLES /  
ANSES /  
GRIFFE

AISLANTES /  
INSULATION /  
ISOLANTES /  
ISOLIERUNG

VARILLA /  
WIRE /  
FILS /  
DRAHT

TUBULAR /  
TUBULAR /  
TUBULAIRE /  
TUBULÄR

TUBULAR /  
TUBULAR /  
TUBULAIRE /  
TUBULÄR

TUBULAR /  
TUBULAR /  
TUBULAIRE /  
TUBULÄR

RESTAURANTE /  
RESTAURANT /  
RESTAURANT /  
RESTAURANT

GASTRONÓMICO /  
GASTRONOMIC /  
GASTRONOMIQUE /  
GASTRONOMIE

TODO TIPO /  
ANY KIND /  
TOUST YPOS /  
ALLE TYPEN

MEDIO /  
MEDIUM /  
MOYEN /  
MITTEL

TRADICIONAL /  
TRADITIONAL /  
TRADITIONNEL /  
TRADITIONELL

RÁPIDA Y CON POCO  
ACEITE /  
FAST AND LITTLE OIL /  
RAPIDE ET AVEC PEU  
D'HUILE /  
SCHNELL UND MIT  
WENIG ÖL

MEDIDAS Ø /  
MEASURES Ø /  
MESURES Ø /  
MASSE Ø

12-60

12-70

16-40

16-60

20-32



BLACK SERIES	MULTIMETAL	COOL • LINE	IDEA	HOBBY CHEF	APARTAMENTO
					
					
€€	€€€€€	€€€	€€€	€€€	€
2	5	4	3	4	2
					
INTEGRADO / INTEGRATED / INTÉGRÉ / INTEGRIERT	TUBULAR / TUBULAR / TUBULAIRE / TUBULÄR	FUNDICIÓN / CAST / FONTE / GUSSEISEN	DISEÑO / DESIGN / DESIGN / DESIGN	VARILLA / WIRE / FILS / DRAHT	BAQUELITA / BAKELITE / BAKÉLITE / BAKELITE
TRADICIONAL Y PRESENTACIÓN / TRADITIONAL AND PRESENTATION / TRADITIONNEL ET PRESENTATION / TRADITIONELL UND PRÄSENTATION	GASTRONÓMICO / GASTRONOMIC / GASTRONOMIQUE / GASTRONOMIE	GOURMET	MODERNA / MODERN / MODERNE / MODERN	GOURMET	LIGERA / LIGHT / LÉGERE / LEICHT
16-40	16-36	16-32	12-32	12-32	14-28



# TOP LINE

LA BATERÍA MÁS EXCLUSIVA PARA LA ALTA COCINA /  
THE MOST EXCLUSIVE COOKWARE LEAD TO HIGH CUISINE /  
LA PLUS EXCLUSIVE BATTERIE POUR LA HAUTE CUISINE /  
EXCLUSIVSTER KOCHBEDARF FÜR DIE GEHOBENE KÜCHE

CUERPO EN ACERO INOXIDABLE 18/10 /  
COOKWARE BODY MADE OF 18/10 STAINLESS STEEL /  
CORPS EN ACIER INOXYDABLE 18/10 /  
KOCHEBEDARF AUS EDELSTAHL 18/10



FACILIDAD: ETIQUETAS IDENTIFICATIVAS DE FÁCIL EXTRACCIÓN /  
EASY: IDENTIFICATION STICKER EASY TO REMOVE /  
FACILE : ETIQUETTES IDENTIFICATRICES FACILES À ENLEVER /  
EINFACH: IDENTIFIZIERUNGSETIKETTEN LEICHT ZU ENTFERNEN

VERTIDO FÁCIL /  
EASY POURING /  
VERCEMENT FACILE /  
SCHÜTTSTRAND

ESTÉTICA: ACABADO SATINADO /  
AESTHETICS: SATIN FINISH /  
ESTHÉTIQUE : FINITION SATINÉE /  
ÄSTHETIK: SATINIERTER AUSFÜHRUNG

CALIDAD: SATINADO UNIFORME EN TODOS LOS MODELOS /  
QUALITY: UNIFORM SATIN POLISHING IN ALL MODELS /  
QUALITÉ : POLISSAGE SATINÉ UNIFORME SUR TOUS LES MODÈLES /  
QUALITÄT: EINHEITLICH MATT GLÄNZEND FÜR ALLE MODELLE



INDUC



GAS



VITRO



ELECTR





EFICIENTE: TAPAS DISEÑADAS PARA EL AHORRO DE ENERGÍA /  
EFFICIENT: LIDS DESIGNED TO SAVE ENERGY /  
EFFICIENT : COUVERCLES CONÇUS POUR ÉCONOMISER DE L'ENERGIE /  
EFFIZIENZ: ENERGIESPARENDES DECKELDESIGN

AISLANTE: ASAS DE INOX RESISTENTES AL CALOR /  
INSULATING: ST/STEEL HEAT RESISTANT HANDLES /  
ISOLANT : ANSES EN ACIER INOXYDABLE RÉSISTANTES À LA CHALEUR /  
ISOLIERUNG: HITZEBSTÄNDIGE GRIFFE AUS EDELSTAHL

INDUCCIÓN: FONDO SANDWICH (INOX - ALU - INOX) /  
INDUCTION: SANDWICH BOTTOM (ST/STEEL - ALU - ST/STEEL) /  
INDUCTION : FOND SANDWICH (INOX - ALU - INOX) /  
INDUKTION: SANDWICHBODEN (EDELSTAHL-ALUMINIUM - EDELSTAHL)

CONTROL: SOLDADURA ARTESANAL E INSPECCIÓN EN CADA UNIDAD /  
CONTROL: HANDCRAFTED WELDING AND CHECKING EVERY UNIT /  
CONTRÔLE : SOUDURE ARTISANALE ET VERIFICATION DE CHAQUE UNITÉ /  
KONTROLLE: HANDANGESCHWEISST UND ÜBERPRÜFUNG JEDER EINHEIT

EFICACIA / EFFICACY /  
EFFICACITÉ / EFFIZIENZ



FRÍO / COLD / FROID / KÄLTE

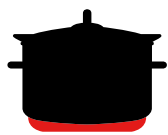

CALIENTE / WARM / CHAUD / HITZE

EFICIENCIA / EFFICACY /  
EFFICACITÉ / EFFIZIENZ

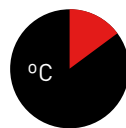

ACERO / INOX-ST/STEEL / EDELSTAHL

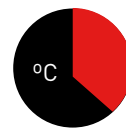

ALUMINIO / ALUMINIUM / ALUMINIUM

## TOP LINE

**P2901** Olla recta sin tapa / Stock pot without lid / Marmite traiteur sans couvercle / Hoher Kochtopf ohne DeckelCLASS  
INDUCTION

NSF



REF	Ø cm	H cm	Lts	U
P290.120	20	20,0	6,20	1
P290.124	24	24,0	10,00	1
P290.128	28	28,0	16,50	1
P290.130	30	30,0	21,20	1
P290.132	32	32,0	24,00	1
P290.135	35	35,0	33,60	1
P290.140	40	40,0	50,00	1
P290.145	45	45,0	72,00	1
P290.150	50	50,0	98,00	1

**P2911** Cacerola baja sin tapa / Casserole without lid / Faitout sans couvercle / Flache Kasserolle ohne DeckelCLASS  
INDUCTION

NSF



REF	Ø cm	H cm	Lts	U
P291.120	20	8,0	2,50	1
P291.124	24	9,5	4,30	1
P291.128	28	11,0	6,70	1
P291.130	30	12,0	8,40	1
P291.132	32	12,5	10,00	1
P291.135	35	14,0	13,60	1
P291.140	40	15,5	19,50	1
P291.145	45	17,0	27,00	1
P291.150	50	20,0	39,00	1
P291.160	60	23,0	65,00	1

**P2921** Cacerola alta sin tapa / Sauce pot without lid / Braisière sans couvercle / Hohe Kasserolle ohne DeckelCLASS  
INDUCTION

NSF



REF	Ø cm	H cm	Lts	U
P292.120	20	13,0	4,00	1
P292.124	24	14,0	6,30	1
P292.128	28	17,5	10,20	1
P292.130	30	18,0	12,70	1
P292.132	32	19,0	15,20	1
P292.135	35	21,0	20,20	1
P292.140	40	25,0	31,40	1
P292.145	45	28,0	44,50	1
P292.150	50	30,0	59,00	1
P292.160	60	35,0	99,00	1

**P2931** Paellera sin tapa / Paella pan without lid / Plat à paella sans couvercle / Paellapfanne ohne DeckelCLASS  
INDUCTION

NSF



REF	Ø cm	H cm	Lts	U
P293.128	28	6,0	3,70	1
P293.132	32	6,0	4,70	1
P293.135	35	7,0	6,70	1
P293.140	40	8,0	10,00	1

**P290** Olla recta con tapa / Stock pot with lid / Marmite traiteur avec couvercle / Hoher Kochtopf mit Deckel



REF	Ø cm	H cm	Lts	U
P290.020	20	20,0	6,20	1
P290.024	24	24,0	10,00	1
P290.028	28	28,0	16,50	1
P290.030	30	30,0	21,20	1
P290.032	32	32,0	24,00	1
P290.035	35	35,0	33,60	1
P290.040	40	40,0	50,00	1
P290.045	45	45,0	72,00	1
P290.050	50	50,0	98,00	1

**P291** Cacerola baja con tapa / Casserole with lid / Faitout avec couvercle / Flache Kasserolle mit Deckel



REF	Ø cm	H cm	Lts	U
P291.020	20	8,0	2,50	1
P291.024	24	9,5	4,30	1
P291.028	28	11,0	6,70	1
P291.030	30	12,0	8,40	1
P291.032	32	12,5	10,00	1
P291.035	35	14,0	13,60	1
P291.040	40	15,5	19,50	1
P291.045	45	17,0	27,00	1
P291.050	50	20,0	39,00	1
P291.060	60	23,0	65,00	1

**P292** Cacerola alta con tapa / Sauce pot with lid / Braisière avec couvercle / Hohe Kasserolle mit Deckel



REF	Ø cm	H cm	Lts	U
P292.016	16	11,0	2,10	1
P292.020	20	13,0	4,00	1
P292.024	24	14,0	6,30	1
P292.028	28	17,5	10,20	1
P292.030	30	18,0	12,70	1
P292.032	32	19,0	15,20	1
P292.035	35	21,0	20,20	1
P292.040	40	25,0	31,40	1
P292.045	45	28,0	44,50	1
P292.050	50	30,0	59,00	1
P292.060	60	35,0	99,00	1

**P293** Paellera con tapa / Paella pan with lid / Plat à paella avec couvercle / Paellapfanne mit Deckel



REF	Ø cm	H cm	Lts	U
P293.028	28	6,0	3,70	1
P293.032	32	6,0	4,70	1
P293.035	35	7,0	6,70	1
P293.040	40	8,0	10,00	1

## TOP LINE

**P201** Cazo recto bajo / Saucepan / Casserole / Flache StielkasserolleCLASS  
INDUCTION

NSF



REF	Ø cm	H cm	Lts	U
P201.016	16	7,5	1,50	1
P201.018	18	8,0	2,00	1
P201.020	20	8,0	2,50	1
P201.024	24	9,5	4,30	1
P201.028	28	11,0	6,70	1
P201.032	32*	12,5	10,00	1

\* Con contraasa / With counterhandle /  
Avec contre anse / mit Zusatzgriff

**P202** Cazo recto alto / Deep saucepan / Casserole haute / Hohe StielkasserolleCLASS  
INDUCTION

NSF



REF	Ø cm	H cm	Lts	U
P202.016	16	11,0	2,10	1
P202.018	18	12,0	3,00	1
P202.020	20	13,0	4,00	1
P202.024	24	14,0	6,30	1
P202.028	28	17,5	10,20	1
P202.032	32*	19,0	15,20	1

\* Con contraasa / With counterhandle /  
Avec contre anse / Mit Zusatzgriff

**P200** Cazo tipo francés / French style saucepan / Casserole forme française / Französische KasserolleCLASS  
INDUCTION

NSF



REF	Ø cm	H cm	Lts	U
P200.012	12	7,0	0,70	1
P200.014	14	7,0	1,00	1
P200.016	16	7,5	1,50	1
P200.018	18	9,0	2,30	1
P200.020	20	10,0	3,10	1
P200.022	22	11,0	4,20	1
P200.024	24	12,0	5,40	1
P200.028	28	14,0	8,60	1

La diferencia entre las refs. 200, 201 y 202 es su altura.  
The only difference between the refs. 200, 201 and 202 is its height.  
La différence entre les réfs. 200, 201 et 202 c'est l'hauteur.  
Die Artikel 200, 201 und 202 unterscheiden sich in der Höhe.

**P214** Cazo cónico / Conical sauté pan / Sauteuse evasée / Konische KasserolleCLASS  
INDUCTION

NSF



REF	Ø cm	H cm	Lts	U
P214.016	16	6,0	1,00	1
P214.018	18	6,0	1,20	1
P214.020	20	6,5	1,60	1
P214.022	22	7,0	2,10	1
P214.024	24	7,5	2,70	1



**P2003** Cazo bombeado / Rounded saucepan / Casserole bombée / Kugelige Kasserolle mit Schüttrand

CLASS  
INDUCTION



REF	Ø cm	H cm	Lts	U
P200.320	20	7,5	1,80	1
P200.324	24	8,5	3,00	1

**P204** Sautex / Sauté pan / Sauteuse / Sauteuse

CLASS  
INDUCTION

NSF



REF	Ø cm	H cm	Lts	U
P204.020	20	6,0	1,90	1
P204.024	24	6,0	2,70	1
P204.028	28	6,0	3,70	1
P204.030	30	6,0	4,30	1
P204.032	32	6,0	4,70	1
P204.035	35	7,0	6,70	1
P204.040	40*	8,0	10,00	1

\* Con contraasa / With counterhandle /  
Avec contre anse / Mit Zusatzgriff

**P299** Tapa / Lid / Couvercle / Deckel



REF	Ø cm	U
P299.016	16	1
P299.020	20	1
P299.024	24	1
P299.028	28	1
P299.030	30	1
P299.032	32	1
P299.035	35	1
P299.040	40	1
P299.045	45	1
P299.050	50	1
P299.060	60	1

COOK,  
ENJOY,  
TRY,  
LIVE  
WITH  
PUJADAS



# INOX-PRO

**DISEÑADA PARA OFRECER EL MAYOR RENDIMIENTO EN LA COCINA PROFESIONAL /  
SPECIALLY DESIGNED TO ACHIEVE THE BEST PERFORMANCE IN THE PROFESSIONAL COOKING /  
CONÇUE POUR OFFRIR LE PLUS HAUT RENDEMENT DANS LA CUISINE PROFESSIONNELLE /  
SPEZIELLES DESIGN FÜR DIE BESTE PERFORMANZ IN DER PROFESSIONELLEN KÜCHE**

**CUERPO EN ACERO INOXIDABLE 18/10 /  
COOKWARE BODY MADE OF 18/10 STAINLESS STEEL /  
CORPS EN ACIER INOXYDABLE 18/10 /  
KOCHKÖRPER AUS EDELSTAHL 18/10**



**SEGURA: ASAS SOLDADAS POR APORTACIÓN DE MATERIALES /  
SAFETY : WELDED HANDLES BY BUILD-UP PROCESS /  
SÉCURITÉ : SOUDURES DES ANSES PAR RÉSTANCE /  
SICHERHEIT: ANGESCHWEISSTE GRIFFE FÜR DIE RESISTENZ**



**SOLIDA Y ROBUSTA: ASAS DE VARILLAS MATIZADA  
EN INOX ULTRARESISTENTES, 500 KG /**

**SOLID AND ROBUST: ST/STEEL WIRE HANDLE  
ULTRA-RESISTANT, 500KG /**

**SOLIDE ET ROBUSTE : ANSES EN FIL INOX  
ULTRA-RÉSISTANTES, 500KG /**

**SOLIDE UND ROBUST: GRIFFE AUS  
EDELSTAHL DRAHT, ULTRA RESISTENT,  
500KG**

**EFICIENTE: TAPAS DISEÑADAS PARA EL AHORRO DE ENERGÍA /  
EFFICIENT: LIDS DESIGNED TO SAVE ENERGY /  
EFFICIENT : COUVERCLES CONÇUS POUR ÉCONOMISER DE L'ÉNERGIE /  
EFFIZIENT: ENERGIESPARENDES DECKELDESIGN**

**ÚNICA: IDENTIFICACIÓN DE ORIGEN Y TIPO FUENTE DE CALOR /  
UNIQUE: ORIGIN IDENTIFICATION AND TYPE OF COOKING SYSTEM /  
UNIQUE : IDENTIFICATION DE L'ORIGINE ET TYPE DE SYSTEME DE CUISSON /  
UNIKAT: HERKUNFTSIDENIFIZIERUNG UND TYP DES KOCHSYSTEMS**



INDUC



GAS



VITRO



ELECTR



GARANTÍA: CONTROL DE TODOS LOS PROCESOS DE FABRICACIÓN /  
WARRANTY: CONTROL OF ALL PRODUCTION PROCESSES /  
GARANTIE : CONTRÔLE DE TOUS LES PROCESSUS DE PRODUCTION /  
GARANTIE: KONTROLLE ALLER FABRIKATIONSPROZESSE

CALIDAD: PULIDO SATINADO INTERIOR Y EXTERIOR  
UNIFORME EN TODOS LOS MODELOS /

QUALITY: INNER AND OUTER SIDES OF ALL MODELS WITH  
UNIFORM SATIN POLISHING /

QUALITÉ : POLISSAGE SATINÉ UNIFORME À L'INTÉRIEUR ET À  
L'EXTÉRIEUR DE TOUS LES MODÈLES /

QUALITÄT: SATINIERTE POLIERUNG INNEN UND AUSSEN  
EINHEITLICH FÜR ALLE MODELLE

RADIOS INTERIORES DISEÑADOS PARA UNA LIMPIEZA FÁCIL Y RÁPIDA /  
RADIUS SPECIALLY DESIGNED FOR EASY AND FAST CLEANING /  
RAYONS PERMETTANT UN ENTRETIEN FACILE ET RAPIDE /  
INNEN-RADIUS DESIGNT FÜR EINFACHE UND SCHNELLE REINIGUNG



CONTROL: SOLDADURA ARTESANAL E INSPECCIÓN EN CADA UNIDAD /  
CONTROL: HANDCRAFTED WELDING AND CHECKING EVERY UNIT /  
CONTRÔLE : SOUDURE ARTISANALE ET VERIFICATION DE CHAQUE UNITÉ /  
KONTROLLE: HANDANGESCHWEISST UND ÜBERPRÜFUNG JEDER EINHEIT

INDUCCIÓN: FONDO SANDWICH (INOX - ALU - INOX) /  
INDUCTION: SANDWICH BOTTOM (ST/STEEL - ALU - ST/STEEL) /  
INDUCTION : FOND SANDWICH (INOX - ALU - INOX) /  
INDUKTION: SANDWICHBODEN (EDELSTAHL-ALUMINIUM-EDELSATHL)

EFICACIA / EFFICACY /  
EFFICACITÉ / EFFIZIENZ

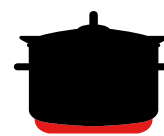

FRÍO / COLD / FROID / KÄLTE

CALIENTE / WARM / CHAUD / HITZE

INOX-PRO

**P218** Olla recta sin tapa / Stock pot without lid / Marmite traiteur sans couvercle / Hoher Kochtopf ohne DeckelCLASS  
INDUCTION

NSF



REF	Ø cm	H cm	Lts	U
P218.016	16	16,0	3,00	1
P218.018	18	18,0	4,50	1
P218.020	20	20,0	6,20	1
P218.024	24	24,0	10,00	1
P218.028	28	28,0	16,50	1
P218.030	30	30,0	21,20	1
P218.032	32	32,0	24,00	1
P218.035	35	35,0	33,60	1
P218.040	40	40,0	50,00	1
P218.045	45	45,0	72,00	1
P218.050	50	50,0	98,00	1
P218.060	60	55,0	155,00	1

**P217** Cacerola baja sin tapa / Casserole without lid / Faitout sans couvercle / Flache Kasserolle ohne DeckelCLASS  
INDUCTION

NSF



REF	Ø cm	H cm	Lts	U
P217.016	16	7,5	1,50	1
P217.018	18	8,0	2,00	1
P217.020	20	8,0	2,50	1
P217.024	24	9,50	4,30	1
P217.028	28	11,0	6,70	1
P217.030	30	12,0	8,40	1
P217.032	32	12,5	10,00	1
P217.035	35	14,0	13,60	1
P217.040	40	15,5	19,50	1
P217.045	45	17,0	27,00	1
P217.050	50	20,0	39,00	1
P217.060	60	23,0	65,00	1

**P216** Cacerola alta sin tapa / Sauce pot without lid / Braisière sans couvercle / Hohe Kasserolle ohne DeckelCLASS  
INDUCTION

NSF



REF	Ø cm	H cm	Lts	U
P216.016	16	11,0	2,10	1
P216.018	18	12,0	3,00	1
P216.020	20	13,0	4,00	1
P216.024	24	14,0	6,30	1
P216.028	28	17,5	10,20	1
P216.030	30	18,0	12,70	1
P216.032	32	19,0	15,20	1
P216.035	35	21,0	20,20	1
P216.040	40	25,0	31,40	1
P216.045	45	28,0	44,50	1
P216.050	50	30,0	59,00	1
P216.060	60	35,0	99,00	1

**P205** Paellera sin tapa / Paella pan without lid / Plat à paella sans couvercle / Paellapfanne ohne DeckelCLASS  
INDUCTION

NSF



REF	Ø cm	H cm	Lts	U
P205.020	20	6,0	1,90	1
P205.024	24	6,0	2,70	1
P205.028	28	6,0	3,70	1
P205.030	30	6,0	4,30	1
P205.032	32	6,0	4,70	1
P205.035	35	7,0	6,70	1
P205.040	40	8,0	10,00	1
P205.045	45	8,5	12,00	1
P205.050	50	9,0	17,50	1
P205.060	60	10,0	28,00	1

**P208** Olla recta con tapa / Stock pot with lid / Marmite traiteur avec couvercle / Hoher Kochtopf mit Deckel

CLASS  
INDUCTION



REF	Ø cm	H cm	Lts	U
P208.016	16	16,0	3,00	1
P208.018	18	18,0	4,50	1
P208.020	20	20,0	6,20	1
P208.024	24	24,0	10,00	1
P208.028	28	28,0	16,50	1
P208.030	30	30,0	21,20	1
P208.032	32	32,0	24,00	1
P208.035	35	35,0	33,60	1
P208.040	40	40,0	50,00	1
P208.045	45	45,0	72,00	1
P208.050	50	50,0	98,00	1
P208.060	60	55,0	155,00	1

**P207** Cacerola baja con tapa / Casserole with lid / Faitout avec couvercle / Flache Kasserolle mit Deckel

CLASS  
INDUCTION



REF	Ø cm	H cm	Lts	U
P207.016	16	7,5	1,50	1
P207.018	18	8,0	2,00	1
P207.020	20	8,0	2,50	1
P207.024	24	9,5	4,30	1
P207.028	28	11,0	6,70	1
P207.030	30	12,0	8,40	1
P207.032	32	12,5	10,00	1
P207.035	35	14,0	13,60	1
P207.040	40	15,5	19,50	1
P207.045	45	17,0	27,00	1
P207.050	50	20,0	39,00	1
P207.060	60	23,0	65,00	1

**P206** Cacerola alta con tapa / Sauce pot with lid / Braisière avec couvercle / Hohe Kasserolle mit Deckel

CLASS  
INDUCTION



REF	Ø cm	H cm	Lts	U
P206.016	16	11,0	2,10	1
P206.018	18	12,0	3,00	1
P206.020	20	13,0	4,00	1
P206.024	24	14,0	6,30	1
P206.028	28	17,5	10,20	1
P206.030	30	18,0	12,70	1
P206.032	32	19,0	15,20	1
P206.035	35	21,0	20,20	1
P206.040	40	25,0	31,40	1
P206.045	45	28,0	44,50	1
P206.050	50	30,0	59,00	1
P206.060	60	35,0	99,00	1

**P215** Paellera con tapa / Paella pan with lid / Plat à paella avec couvercle / Paellapfanne mit Deckel

CLASS  
INDUCTION



REF	Ø cm	H cm	Lts	U
P215.020	20	6,0	1,90	1
P215.024	24	6,0	2,70	1
P215.028	28	6,0	3,70	1
P215.030	30	6,0	4,30	1
P215.032	32	6,0	4,70	1
P215.035	35	7,0	6,70	1
P215.040	40	8,0	10,00	1
P215.045	45	8,5	12,00	1
P215.050	50	9,0	17,50	1
P215.060	60	10,0	28,00	1

INOX-PRO

## P240 Conjunto cuscusera bombeada, con tapa / Conical couscous set with lid / Couscoussier bombée avec couvercle / Konisches Couscoustopfset mit Deckel

**CLASS**  
**INDUCTION**

REF	Ø cm	H cm	Lts	U
P240.040	A 40	20,0	20,00	1
	B 32	32,0	24,00	
P240.050	A 50	25,0	40,00	1
	B 40	40,0	50,00	
P240.070	A 70	25,0	65,00	1
	B 50	50,0	98,00	

## P241 Parte superior de cuscusera bombeada / Top for couscous set conical shape / Dessus seul pour couscoussier forme bombée / Oberteil vom konischen Couscoustopfset



REF	Ø cm	H cm	Lts	U
P241.040	40	20,0	20,00	1
P241.050	50	25,0	40,00	1
P241.060	60	23,5	45,00	1
P241.070	70	25,0	65,00	1

Ø agujeros / holes / trous / Löcher 4 mm  
Sin tapa / Without lid / Sans couvercle / Ohne Deckel

## P242 Conjunto cuscusera forma recta / Straight couscous set / Couscoussier forme droite / Couscoustopfset gerade Form

**CLASS**  
**INDUCTION**

REF	Ø cm	H cm	Lts	U
P242.020	A 20	13,0	4,00	1
	B 20	20,0	6,20	
P242.024	A 24	14,0	6,30	1
	B 24	24,0	10,00	
P242.028	A 28	17,5	10,00	1
	B 28	28,0	16,50	
P242.032	A 32	19,0	15,00	1
	B 32	32,0	24,00	
P242.035	A 35	21,0	20,00	1
	B 35	35,0	33,60	

Con tapa / With lid / Avec couvercle / Mit Deckel

## P243 Parte superior de vaporera y cuscusera / Top for steam pot and couscous set straight shape / Dessus seul pour couscoussier forme droite et cuit vapeur / Oberteil Dampfgarer und Couscoustopf



REF	Ø cm	H cm	Lts	U
P243.020	20	13,0	4,00	1
P243.024	24	14,0	6,30	1
P243.028	28	17,5	10,00	1
P243.032	32	19,0	15,00	1
P243.035	35	21,0	20,00	1

Ø agujeros / holes / trous / Löcher 3,25 mm  
Sin tapa / Without lid / Sans couvercle / Ohne Deckel

## P244 Conjunto vaporera / Steam pot / Cuit vapeur / Dampfgarset

**CLASS**  
**INDUCTION**

REF	Ø cm	H cm	Lts	U
P244.020	A 20	13,0	4,00	1
	B 20	13,0	4,00	
P244.024	A 24	14,0	6,30	1
	B 24	14,0	6,30	
P244.028	A 28	17,5	10,00	1
	B 28	17,5	10,00	
P244.032	A 32	19,0	15,00	1
	B 32	19,0	15,00	
P244.035	A 35	21,0	20,00	1
	B 35	21,0	20,00	

Con tapa / With lid / Avec couvercle / Mit Deckel



**P223** Conjunto cacerola + 4 colapastas / Casserole set + 4 pasta colander /  
Ensemble braisière + 4 cuit-pâtes / Kasserolleset + 4 Nudelsiebe

CLASS  
INDUCTION



REF	Ø cm	H cm	Lts	U
P223.035	35	21,0	20,20	1
P223.040	40	25,0	31,40	1

Datos relativos a la cacerola 216.  
Casserole data 216.  
Caractéristiques afférentes au braisière 216.  
Entsprechende Eigenschaften der Kasserolle 216.

Sin tapa / Without lid / Sans couvercle / Ohne Deckel

**P224** Colapasta / Pasta colander / Cuit-pâtes / Nudelsieb



REF	H cm	U
A P224.023	23,0	1
B P224.026	26,0	1

A Utilizable para la ref. 216 - Ø 35 cm B Utilizable para la ref. 216 - Ø 40 cm  
A It fits ref. 216 - Ø 35 cm B It fits ref. 216 - Ø 40 cm  
A Utilisable pour la ref. 216 - Ø 35 cm B Utilisable pour la ref. 216 - Ø 40 cm  
A Benutzbar für Art.Nr. 216 - Ø 35 cm B Benutzbar für Art.Nr. 216 - Ø 40 cm

**P248** Olla con grifo y tapa / Stock pot with tap and lid /  
Marmite traiteur avec robinet et couvercle / Topf mit Ablaufahn und Deckel

CLASS  
INDUCTION



REF	Ø cm	H cm	Lts	U
P248.028	28	28,0	16,50	1
P248.032	32	32,0	24,00	1
P248.035	35	35,0	33,60	1
P248.040	40	40,0	50,00	1
P248.045	45	45,0	72,00	1

**P249** Separador para olla con grifo / Grid for stock pot with tap /  
Grille pour marmite avec robinet / Separierer für Topf mit Ablaufahn

**IDEA!**

Perfecto para la esterilización de tarros /  
Ideal for sterilizing jars /  
Idéal pour la stérilisation des bocaux /  
Ideal für die Sterilisierung von Glasbehältern



REF	Ø cm	H cm	U
P249.028	27,5	5,50	1
P249.032	31,5	5,50	1
P249.035	34,5	5,50	1
P249.040	39,5	5,50	1
P249.045	44,5	5,50	1

**P209** Tapa / Lid / Couvercle / Deckel



REF	Ø cm	U
P209.014	14	1
P209.016	16	1
P209.018	18	1
P209.020	20	1
P209.022	22	1
P209.024	24	1
P209.028	28	1
P209.030	30	1
P209.032	32	1
P209.035	35	1
P209.040	40	1
P209.045	45	1
P209.050	50	1
P209.060	60	1

INOX-PRO

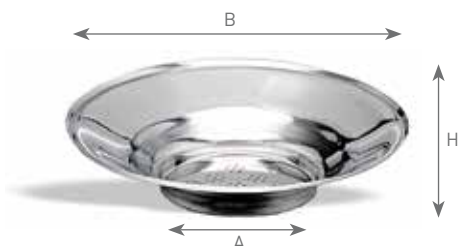
**P211** Escurrefritos / Fry colander / Passoire à frites / Frittensieb

REF	Ø A cm	Ø B cm	H cm	U
P211.018	18	37,5	7,5	1
P211.020	20	38,0	7,5	1

**P210** Pote / Pot / Pot / TopfCLASS  
INDUCTION

REF	Ø cm	H cm	Lts	U
P210.016	16	16,0	3,00	1
P210.018	18	18,0	4,50	1
P210.020	20	20,0	6,20	1

**P203** Baño maría / Bain marie / Bain-marie / WasserbadCLASS  
INDUCTION

NSF



REF	Ø cm	H cm	Lts	U
P203.016	16	16,0	3,00	1
P203.018	18	18,0	4,50	1
P203.020	20	20,0	6,20	1
P203.024	24	24,0	10,00	1

Con fondo termodifusor tipo sandwich  
With diffusing bottom sandwich type  
Avec fond thermo diffuseur type sandwich  
Mit Thermodiffusionsboden Typ Sandwich

**P219** Baño maría sin fondo sandwich / Bain marie without sandwich bottom /  
Bain-marie sans fond sandwich / Wasserbad ohne Sandwichboden

REF	Ø cm	H cm	Lts	U
P219.016	16	16,0	3,00	1
P219.018	18	18,0	4,50	1
P219.020	20	20,0	6,20	1

**P212** Baño maría sin fondo sandwich / Bain marie without sandwich bottom /  
Bain-marie sans fond sandwich / Wasserbad ohne Sandwichboden

REF	Ø cm	H cm	Lts	U
P212.016	16	16,0	3,00	1
P212.018	18	18,0	4,50	1
P212.020	20	20,0	6,20	1

IDEA!

Perfecto para salsas /  
Perfect for sauces /  
Parfait pour sauces /  
Perfekt für Sossen

**P204** Sautex / Sauté pan / Sauteuse / SauteuseCLASS  
INDUCTION

NSF



REF	Ø cm	H cm	Lts	U
P204.020	20	6,0	1,90	1
P204.024	24	6,0	2,70	1
P204.028	28	6,0	3,70	1
P204.030	30	6,0	4,30	1
P204.032	32	6,0	4,70	1
P204.035	35	7,0	6,70	1
P204.040*	40	8,0	10,00	1

\* Con contraasa / With counterhandle /  
Avec contre anse / Mit Zusatzgriff

**P201** Cazo recto bajo / Saucepan /  
Casserole / Stielkasserolle

CLASS  
INDUCTION

NSF



\* Con contraasa / With counterhandle /  
Avec contre anse / Mit Zusatzgriff

REF	Ø cm	H cm	Lts	U
P201.016	16	7,5	1,50	1
P201.018	18	8,0	2,00	1
P201.020	20	8,0	2,50	1
P201.024	24	9,5	4,30	1
P201.028	28	11,0	6,70	1
P201.032	32*	12,50	10,00	1

**P202** Cazo recto alto / Deep saucepan /  
Casserole haute / Hohe Stielkasserolle

CLASS  
INDUCTION

NSF



\* Con contraasa / With counterhandle /  
Avec contre anse / Mit Zusatzgriff

REF	Ø cm	H cm	Lts	U
P202.016	16	11,0	2,10	1
P202.018	18	12,0	3,00	1
P202.020	20	13,0	4,00	1
P202.024	24	14,0	6,30	1
P202.028	28	17,5	10,20	1
P202.032	32*	19,0	15,20	1

**P200** Cazo tipo francés /  
French style saucepan /  
Casserole forme française /  
Französische Kasserolle

CLASS  
INDUCTION

NSF



REF	Ø cm	H cm	Lts	U
P200.012	12	7,0	0,70	1
P200.014	14	7,0	1,00	1
P200.016	16	7,5	1,50	1
P200.018	18	9,0	2,30	1
P200.020	20	10,0	3,10	1
P200.022	22	11,0	4,20	1
P200.024	24	12,0	5,40	1
P200.028	28	14,0	8,60	1

**P2001** Cazo con picos laterales /  
Saucepan with side spouts /  
Casserole avec becs verseurs /  
Stielkasserolle mit Ausgüssen

CLASS  
INDUCTION



REF	Ø cm	H cm	Lts	U
P200.116	16	7,5	1,50	1
P200.120	20	10,0	3,10	1

**P214** Cazo cónico /  
Conical sauté pan /  
Sauteuse evasée /  
Konische Stielkasserolle

CLASS  
INDUCTION

NSF



REF	Ø cm	H cm	Lts	U
P214.016	16	6,0	1,00	1
P214.018	18	6,0	1,20	1
P214.020	20	6,5	1,60	1
P214.022	22	7,0	2,10	1
P214.024	24	7,5	2,70	1

**P2003** Cazo bombeado /  
Rounded saucepan /  
Casserole bombée /  
Kugelige Stielkasserolle mit Schüttrand

CLASS  
INDUCTION



REF	Ø cm	H cm	Lts	U
P200.320	20	7,5	1,80	1
P200.324	24	8,5	3,00	1

HANDY



INOX - ST/STEEL  
EDELSTAHL  
18/10



ESPAÑOL

BATERÍA DE ACERO INOXIDABLE CON ASAS TUBULARES, RESISTENTES AL CALOR.  
FONDO TERMO DIFUSOR ENCAPSULADO.

ENGLISH

ST/STEEL COOKWARE WITH HEAT-RESISTANT TUBULAR HANDLES.  
ENCAPSULATED SANDWICH BASE.

FRANÇAIS

BATTERIE DE CUISINE FABRIQUÉE EN ACIER INOXYDABLE AVEC ANSES TUBULAIRES RÉTANTES À LA CHALEUR.  
FOND THERMO-DIFFUSEUR ENCAPSULÉ

DEUTSCH

KOCHBEDARF AUS EDELSTAHL MIT HITZEBESTÄNDIGEN ROHRGRIFFEN.  
KAPSELFÖRMIGER THERMODIFFUSIONSUNTERBODEN.

### P4008 Olla sin tapa / Stock pot without lid / Marmite traiteur sans couvercle / Kochtopf ohne Deckel



REF	Ø cm	H cm	Lts	U
P400.824	24	20,0	9,00	1
P400.828	28	24,0	14,50	1
P400.832	32	28,0	22,50	1
P400.835	35	30,0	28,50	1

### P4007 Cacerola baja sin tapa / Casserole without lid / Faitout sans couvercle / Flache Kasserolle ohne Deckel



REF	Ø cm	H cm	Lts	U
P400.724	24	9,5	4,20	1
P400.728	28	11,0	6,50	1
P400.732	32	12,5	10,00	1
P400.735	35	13,0	12,50	1

**P4006** Cacerola alta sin tapa / Sauce pot without lid / Braisière sans couvercle / Hohe Kasserolle ohne Deckel



REF	Ø cm	H cm	Lts	U
P400.624	24	14,0	6,20	1
P400.628	28	16,0	9,50	1
P400.632	32	19,0	15,00	1
P400.635	35	20,0	19,00	1
P400.640	40	32,0	40,00	1

**P4000** Cazo recto / Saucepan / Casserole / Hohe Kasserolle



REF	Ø cm	H cm	Lts	U
P400.016	16	7,5	1,40	1
P400.018	18	9,0	2,10	1
P400.020	20	10,0	3,00	1
P400.024	24	12,0	5,00	1

**P4003** Cazo bombeado / Rounded saucepan / Casserole bombée / Kugelige Stielkasserolle mit Schüttrand



REF	Ø cm	H cm	Lts	U
P400.320	20	7,5	2,00	1
P400.324	24	8,5	3,70	1

**P4004** Sautex / Sauté pan / Sauteuse / Sauteuse



REF	Ø cm	H cm	Lts	U
P400.424	24	6,0	2,50	1

**P4009** Tapa / Lid / Couvercle / Deckel



REF	Ø cm	U
P400.916	16	1
P400.918	18	1
P400.920	20	1
P400.924	24	1
P400.928	28	1
P400.932	32	1
P400.935	35	1
P400.940	40	1



ESPAÑOL

BATERÍA DE ALUMINIO PURO 99.5% EXTRA FUERTE

ENGLISH

PURE 99,5% EXTRA STRENGTH ALUMINIUM COOKWARE

FRANÇAIS

BATTERIE DE CUISINE EN ALUMINIUM PUR À 99,5% EXTRA FORT

DEUTSCH

KOCHBEDARF AUS 99,5% EXTRA STARKEN ALUMINIUM

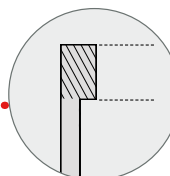

Bordes reforzados  
Reinforced rims  
Bords renforcés  
Verstärkte Ränder

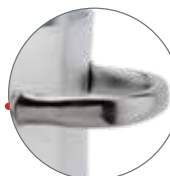

Asas ergonómicas  
Ergonomic handles  
Anses ergonomiques  
Ergonomische Griffe



Remache de alta resistencia  
Extremely strong riveted handles  
Poignées rivetées de haute résistance  
Extrem starke Vernietung

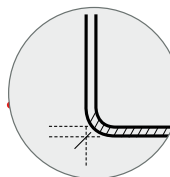

Fondo reforzado  
Reinforced base  
Fond renforcé  
Verstärkter Boden



Excelente conductividad térmica y alta eficiencia en la difusión del calor  
Excellent thermo conductivity and exceptional efficiency on heat distribution  
Excellente conductivité thermique et haute efficacité en diffusion de la chaleur  
Exzellente Wärmeleitung und hohe Effizienz der Hitzeverteilung



**P1181** Olla sin tapa / Stock pot without lid / Marmite traiteur sans couvercle / Kochtopf ohne Deckel



REF	Ø cm	H cm	Lts	U
P118.125	25	25,0	12,00	1
P118.127	27	27,0	15,00	1
P118.130	30	30,0	21,20	1
P118.132	32	32,0	25,50	1
P118.135	35	35,0	33,60	1
P118.140	40	40,0	50,00	1
P118.145	45	45,0	72,00	1
P118.150	50	50,0	98,00	1
P118.160	60	60,0	155,00	1

**P1171** Cacerola baja sin tapa / Casserole without lid / Faitout sans couvercle / Flache Kasserolle ohne Deckel



REF	Ø cm	H cm	Lts	U
P117.125	25	10,0	5,00	1
P117.127	27	11,0	6,00	1
P117.130	30	12,0	8,50	1
P117.132	32	13,0	10,00	1
P117.135	35	14,0	13,00	1
P117.138	38	15,0	17,00	1
P117.140	40	16,0	20,00	1
P117.145	45	18,0	28,00	1
P117.150	50	21,0	41,00	1
P117.160	60	25,0	70,00	1

**P1161** Cacerola alta sin tapa / Sauce pot without lid / Braisière sans couvercle / Hohe Kasserolle ohne Deckel



REF	Ø cm	H cm	Lts	U
P116.125	25	15,0	7,30	1
P116.130	30	18,0	12,70	1
P116.135	35	21,0	20,20	1
P116.140	40	25,0	31,40	1
P116.145	45	28,0	44,50	1
P116.150	50	31,0	60,80	1
P116.160	60	37,0	104,60	1

**P115** Paellera sin tapa / Paella pan without lid / Plat à paella sans couvercle / Paellapfanne ohne Deckel



REF	Ø cm	H cm	Lts	U
P115.020	20	5,5	1,75	1
P115.024	24	6,0	2,75	1
P115.028	28	6,0	3,75	1
P115.032	32	7,0	5,60	1
P115.040	40	8,0	10,00	1
P115.050	50	8,0	15,50	1
P115.060	60	10,0	28,00	1

ALU-PRO

**P118** Olla con tapa / Stock pot with lid / Marmite traiteur avec couvercle / Kochtopf mit Deckel

REF	Ø cm	H cm	Lts	U
P118.025	25	25,0	12,00	1
P118.027	27	27,0	15,00	1
P118.030	30	30,0	21,20	1
P118.032	32	32,0	25,50	1
P118.035	35	35,0	33,60	1
P118.040	40	40,0	50,00	1
P118.045	45	45,0	72,00	1
P118.050	50	50,0	98,00	1
P118.060	60	60,0	155,00	1

**P117** Cacerola baja con tapa / Casserole with lid / Faitout avec couvercle / Flache Kasserolle mit Deckel

REF	Ø cm	H cm	Lts	U
P117.025	25	10,0	5,00	1
P117.027	27	11,0	6,00	1
P117.030	30	12,0	8,50	1
P117.032	32	13,0	10,00	1
P117.035	35	14,0	13,00	1
P117.038	38	15,0	17,00	1
P117.040	40	16,0	20,00	1
P117.045	45	18,0	28,00	1
P117.050	50	21,0	41,00	1
P117.060	60	25,0	70,00	1

**P116** Cacerola alta con tapa / Sauce pot with lid / Braisière avec couvercle / Hohe Kasserolle mit Deckel

REF	Ø cm	H cm	Lts	U
P116.025	25	15,0	7,30	1
P116.030	30	18,0	12,70	1
P116.035	35	21,0	20,20	1
P116.040	40	25,0	31,40	1
P116.045	45	28,0	44,50	1
P116.050	50	31,0	60,80	1
P116.060	60	37,0	104,60	1

**P1151** Paellera con tapa / Paella pan with lid / Plat à paella avec couvercle / Paellapfanne mit Deckel

REF	Ø cm	H cm	Lts	U
P115.132	32	7,0	5,60	1
P115.140	40	8,0	10,00	1
P115.150	50	8,0	15,50	1
P115.160	60	10,0	28,00	1

**P106** Sautex / Sauté pan / Sauteuse / Sauteuse



REF	Ø cm	H cm	Lts	U
P106.020	20	5,5	1,75	1
P106.024	24	6,0	2,75	1
P106.028	28	6,0	3,75	1
P106.032	32	7,0	5,60	1
P106.040	40	8,0	10,00	1

**P103** Cazo bombeado / Rounded saucepan / Casserole bombée / Kugelige Stielkasserolle mit Schüttrand



REF	Ø cm	H cm	Lts	U
P103.016	16	8,0	1,00	1
P103.018	18	9,0	2,00	1
P103.020	20	10,5	2,50	1
P103.022	22	11,0	3,00	1
P103.024	24	12,0	4,00	1
P103.028	28	14,0	6,50	1

**P104** Cazo recto / Saucepan / Casserole / Gerade Kasserolle



REF	Ø cm	H cm	Lts	U
P104.016	16	8,0	1,50	1
P104.018	18	9,0	2,00	1
P104.020	20	10,0	3,00	1
P104.022	22	11,0	4,00	1
P104.024	24	12,0	5,00	1
P104.026	26	13,0	6,00	1

**P112** Tapa / Lid / Couvercle / Deckel



REF	Ø cm	U
P112.020	20	1
P112.025	25	1
P112.027	27	1
P112.030	30	1
P112.032	32	1
P112.035	35	1
P112.038	38	1
P112.040	40	1
P112.045	45	1
P112.050	50	1
P112.060	60	1









# SARTENES

ESPAÑOL

## MANGOS:

LOS MANGOS SON UNO DE LOS ELEMENTOS DE DIFERENCIACIÓN FUNCIONAL MÁS IMPORTANTES. DE ESTA FORMA PUJADAS ADAPTÁNDOSE A LAS NUEVAS TENDENCIAS EN EL SECTOR DE LA COCINA PROFESIONAL IMPULSA Y PROMOCIONA LOS DISEÑOS:

**ERGOS:** FABRICADOS EN TUBO DE ACERO INOXIDABLE, CON UN DISEÑO ERGONÓMICO Y EXCLUSIVO, RESISTENTE A LA TRANSMISIÓN DEL CALOR. MÁXIMO RENDIMIENTO EN LA COCINA PROFESIONAL.

**HÉRCULES:** MANGOS TRADICIONALES FABRICADOS EN HIERRO PLANO CON RECUBRIMIENTO "EPOXY" RESISTENTE AL CALOR. ALTAMENTE ACONSEJADOS PARA UN USO INTENSIVO.

**BAQUELITA:** FABRICADOS EN 100% BAQUELITA, AISLANTE DEL CALOR Y MÁS LIGEROS. IDEALES PARA UN USO DOMÉSTICO O POCO FRECUENTE.

## ANTIADHERENTES:

**SARTENES DE ALUMINIO:** ANTIADHERENTE PROFESIONAL MULTICAPA EN LAS SARTENES DE 4 MM DE ESPESOR Y TITANIUM EN LAS DE 5 MM. BUENA RESISTENCIA A LA ABRASIÓN Y LARGA DURABILIDAD.

**SARTENES DE ACERO INOXIDABLE Y MULTIMETAL:** EXCALIBUR, ANTIADHERENTE DE ÚLTIMA GENERACIÓN BASADO EN UN REFUERZO DE ACERO INOXIDABLE QUE SE INTEGRA EN EL SUBSTRATO METÁLICO PASANDO A FORMAR PARTE DEL MISMO Y LOGRANDO LA COMBINACIÓN ÚNICA DE LA DUREZA DEL ACERO INOXIDABLE CON LAS CARACTERÍSTICAS DE ANTIADHERENCIA. RESISTENTE A LA EROSIÓN DE LOS UTENSILIOS MÁS AGRESIVOS. (VER CUADRO INFORMATIVO).

# FRY PANS

ENGLISH

## HANDLES:

HANDLES ARE ONE OF THE MOST IMPORTANT DIFFERENTIATING FUNCTIONAL ELEMENTS. PUJADAS HAS ADAPTED TO THE LATEST TRENDS IN THE PROFESSIONAL COOKING SECTOR AND FOR THIS REASON HIGHLIGHTS AND PROMOTES THE FOLLOWING DESIGNS:

**ERGOS:** MADE OF ST/STEEL TUBE WITH AN EXCLUSIVE, HEAT-RESISTANT, ERGONOMIC DESIGN. THE BEST PERFORMANCE WITH PROFESSIONAL USE.

**HERCULES:** TRADITIONAL HANDLES MADE OF FLAT IRON WITH A HEAT RESISTANT "EPOXY" COATING. HIGHLY RECOMMENDED FOR INTENSIVE USE.

**BAKELITE:** MADE OF 100% HEAT-RESISTANT BAKELITE. SUGGESTED FOR HOUSEHOLD OR NON-INTENSIVE USE.

## NON-STICK COATINGS:

**ALUMINIUM FRY PANS:** NON-STICK PROFESSIONAL MULTI LAYER COATING APPLIED ON THE 4 MM THICK FRY PANS AND TITANIUM ON THE 5 MM ONES. LONG-LASTING AND HIGH RESISTANCE TO ABRASION.

**ST/STEEL AND MULTIMETAL FRY PANS:** EXCALIBUR, A NON-STICK COATING OF THE LATEST GENERATION. A SYSTEM WHERE THE NON-STICK COATING FORMS AN INTEGRAL PART OF THE BASE DUE TO THE ADDITION OF A COAT OF POWDERED ST/STEEL. EFFECTIVELY COMBINING THE DURABILITY OF ST/STEEL WITH THE NON-STICK PROPERTIES OF THE FLUOROPOLYMER. RESISTANT TO THE EFFECTS OF THE MOST AGGRESSIVE KITCHEN UTENSILS. (SEE INFORMATIVE TABLE).

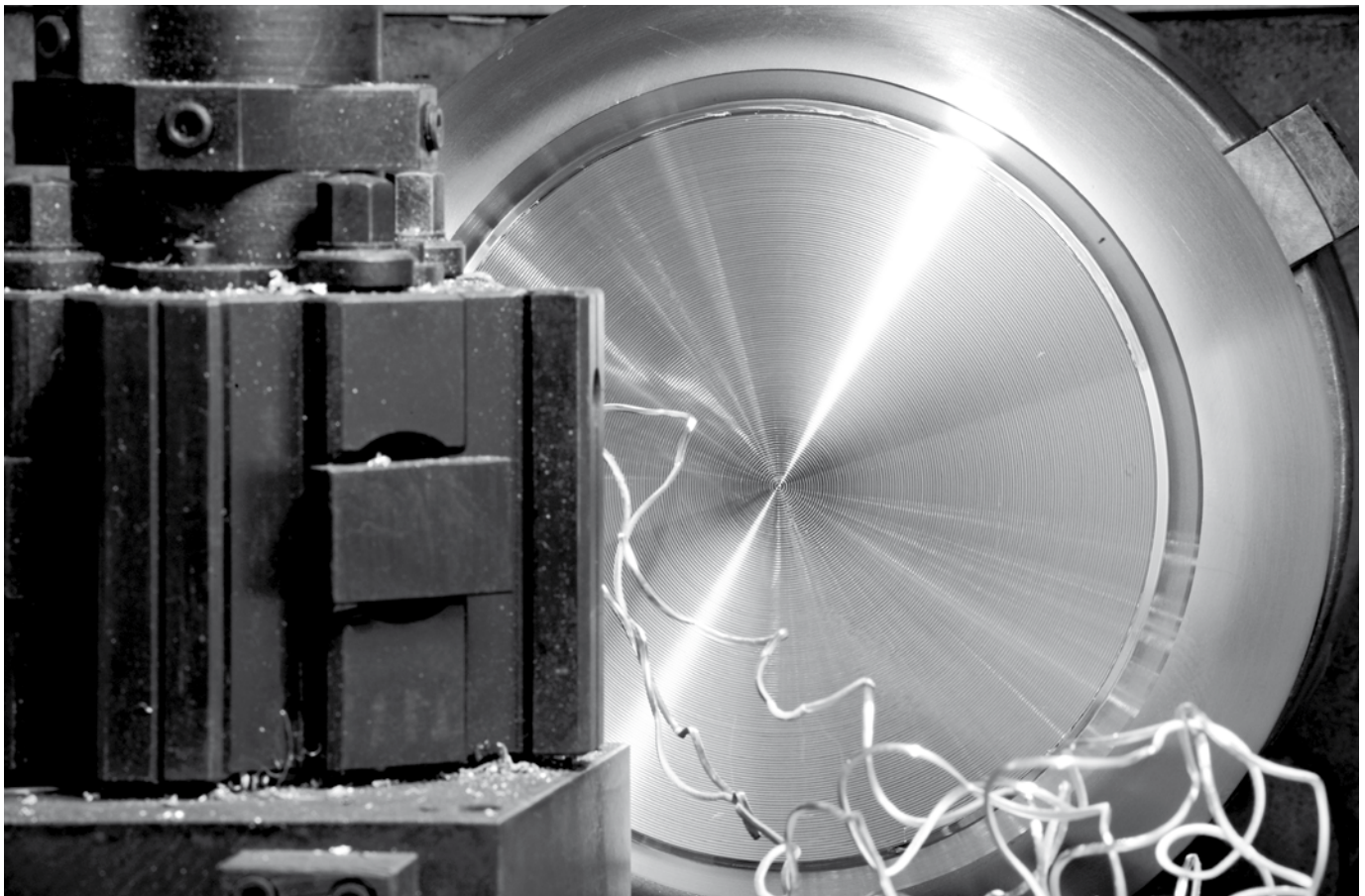



# POÊLES

FRANÇAIS

## QUEUES :

LES QUEUES SONT UN DES ÉLÉMENTS DE DIFFÉRENCIATION FONCTIONNELLE LES PLUS IMPORTANTS. AINSI DONC, PUJADAS EN S'ADAPTANT AUX NOUVELLES TENDANCES DU SECTEUR DE LA CUISINE PROFESSIONNELLE, OPTÉ ET MISE POUR LES NOUVEAUX DESSINS:

**ERGOS:** FABRIQUÉES EN TUBE D'ACIER INOXYDABLE, DESSIN ERGONOMIQUE ET EXCLUSIF, RÉSISTANT À CHALEUR. RENDEMENT MAXIMAL EN UTILISATION PROFESSIONNELLE.

**HÉRCULES:** FORME TRADITIONNELLE EN FER À REVÊTEMENT "ÉPOXY", RÉSISTANT À LA CHALEUR. HAUTEMENT RECOMMANDÉS POUR UNE UTILISATION INTENSIVE.

**BAKÉLITE:** FABRIQUÉES 100% BAKÉLITE, RÉSISTANTES À LA CHALEUR ET PLUS LÉGÈRES. IDÉALES POUR UNE UTILISATION DOMESTIQUE OU PEU FRÉQUENTE.

## ANTI-ADHÉSIF :

### POÊLES EN ALUMINIUM :

REVÊTEMENT PROFESSIONNEL ANTI-ADHÉRENT MULTICOUCHE APPLIQUÉ SUR LES POÊLES DE 4MM D'ÉPAISSEUR ET TITANIUM SUR CELLES DE 5MM. LONGUE ET FORTE RÉSISTANCE À L'ABRASION.

### POÊLES EN ACIER INOXYDABLE ET MULTI-MÉTAL :

EXCALIBUR, UN REVÊTEMENT DE NOUVELLE GÉNÉRATION, BASÉ SUR UN RENFORT EN ACIER INOXYDABLE, QUI S'INTÈGRE DANS LE SUBSTRAT MÉTALLIQUE DONT IL FAIT PARTIE, CE QUI DONNE UNE COMBINAISON UNIQUE ENTRE LA DURETÉ DE L'ACIER ET LES CARACTÉRISTIQUES DE L'ANTI-ADHÉSIF. LE REVÊTEMENT EXCALIBUR RÉSISTE MÊME AUX USTENSILES LES PLUS DURS. (VOIR TABLEAU INFORMATIF).



## DETALLE TRATAMIENTO ANTIADHERENTE / NON-STICK COATING TREATMENT / DÉTAIL APPLICATION ANTI-ADHÉSIF / BEHANDLUNG MIT ANTIHAFTBESCHICHTUNG



1 Para dar rugosidad a la superficie de la pieza se chorrea con elementos abrasivos y con ello se logra un buen anclaje del excalibur.

1 The surface of the substrate is blasted with an abrasive to roughen it, so other elements in the excalibur process adhere to it better.

1 Afin de la rendre rugueuse, la surface de la pièce est sablée avec un abrasif; ceci permettra une excellente tenue du procédé excalibur.

1 Um der Oberfläche eine Rauheit zu geben wird sie mit rauen Elementen bestrahlt. Dies erlaubt einen exzellenten Halt von anderen Elementen im Excalibur Prozess.

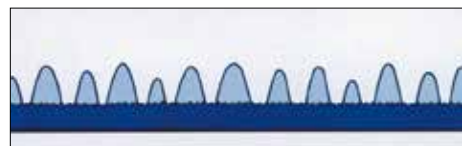

3 Las partículas se enfrían, formando parte integral de la superficie con "picos" y "valles" que permiten alojar las capas de antiadherente de forma permanente.

3 The particles cool and harden, bonded to the surface, forming a series of "peaks and valleys" that provide a permanent base for the non-stick coatings.

3 Ces particules se refroidissent, forment des crêtes et des vallées constituant une excellente base permanente d'accrochage et de renforcement de l'anti-adhésif.

3 Die Partikel kühlen sich ab und integrieren sich in der Oberfläche in Form von "Höhen und Tiefen". Dies ermöglicht eine permanente Grundlage für die Antihafbeschichtung.

# BRATPFANNEN

DEUTSCH

## GRIFFE :

DIE GRIFFE SIND EINE DER WICHTIGSTEN UNTERSCHIEDUNGSMERKMALE DER FUNKTIONALITÄT. PUJADAS WIRD VON DEN NEUESTEN TRENDS DER PROFESSIONELLEN KÜCHE ANGETRIEBEN UND ENTWICKELT FOLGENDE DESIGNS:

**ERGOS:** FERTIGUNG AUS ROSTFREIEM EDELSTAHLROHR, EXCLUSIVES UND ERGONOMISCHES DESIGN, HITZEBESTÄNDIGKEIT, MAXIMALE HANDHABUNG IN DER PROFESSIONELLEN KÜCHE.

**HÉRCULES:** TRADITIONELL GEFERTIGTE GRIFFE AUS FLACHEISEN MIT DER "ÉPOXY" BESCHICHTUNG, HITZEBESTÄNDIG. HÖCHST EMPFEHLENSWERT BEI EINEM INTENSIVEN GEBRAUCH.

**BAKELITE:** GEFERTIGT AUS 100% BAKELITE, HITZEBESTÄNDIG UND SEHR LEICHT. IDEAL FÜR DEN HAUSGEBRAUCH ODER WENIGEN GEBRAUCH.

## ANTIHAFT BESCHICHTUNG:

### BRATPFANNEN AUS ALUMINIUM:

MEHRFACHE PROFESSIONELLE ANTIHAFTBESCHICHTUNG DER BRATPFANNEN VON 4MM DICKE UND TITANIUM VON 5MM DICKE. GUTE WIDERSTANDSFÄHIGKEIT GEGEN VERSCHLEISS UND FÜR DIE LANGLEBIGKEIT.

### BRATPFANNEN AUS EDELSTAHL UND MULTIMETALL:

EXCALIBUR, ANTIHAFTBESCHICHTUNG DER NEUESTEN GENERATION BASIEREND AUF EINE VERSTÄRKUNG DURCH EDELSTAHL, DASS SICH IM METALLISCHEM SUBSTRAT SO INTEGRIERT, DASS ES EIN BESTANDTEIL DESSELBEN WIRD. HIERDURCH WIRD EINE EINZIGARTIGE KOMBINATION VON STAHLHÄRTE UND ANTIHAFTUNG ERREICHT. RESISTENT GEGEN DIE AGGRESSIVSTEN UTENSILIEN. (SIEHE WEITERE INFORMATIONEN UNTEN)



2 La parte más importante del proceso: la pulverización y deposición de las partículas fundidas de una aleación de acero inoxidable, patentada por whitford.

2 Then, the most important part: white-hot particles of a special stainless steel (whitford's patented alloy) are sprayed onto the roughened surface.

2 Le processus plus important: des particules d'un acier inoxydable spécial (protégé par brevet par whitford) sont chauffées à blanc et pulvérisées sur la pièce.

2 Der wichtigste Prozessschritt: Die Pulverisierung und Ablagerung der Schmelzpartikel formt sich zu einer speziellen Legierung (whitford Legierung patentiert).



4 Finalmente se aplican varias capas de fluoropolímeros que rellenan los "valles" y cubren los "picos", los cuales protegen el recubrimiento antiadherente.

4 Several coats of tough fluoropolymers fill the "valleys" and cover the "peaks", held permanently in place by the special stainless steel "peaks".

4 Des couches d'anti-adhésif très résistantes sont appliquées; elles remplissent les vallées, recouvrent juste le haut des crêtes qui les maintiennent fermement en place.

4 Schliesslich werden unterschiedliche Schichten aus Fluorpolymer über die "Höhen und Tiefen" aufgetragen, um die Antihafbeschichtung zu schützen.

PROFESIONAL / PROFESSIONAL / PROFESSIONNEL / PROFESSIONELL

	ACERO INOXIDABLE / ST/STEEL / ACIER INOXYDABLE / ROSTFREIER STAHL	ALUMINIO INDUCCIÓN / INDUCTION ALUMINIUM / ALUMINIUM INDUCTION / ALUMINIUMINDUKTION	ALUMINIO / ALUMINIUM / ALUMINIUM / ALUMINIUM		ACERO / STEEL / ACIER / STAHL
REF / ITEM / CODE / ART.NR.					
COMPATIBLE CON / COMPATIBLE WITH / COMPATIBLE AVEC / GEEIGNET FÜR					
PRECIO / PRICE / PRIX / PREIS	€€€	€	€	€€€	€
ESPESOR / THICKNESS / EPAISSEUR / DICKE	0,8 mm	4 mm	4,5 mm	4 mm	1,5 mm
ANTIADHERENTE / COATING / REVÊTEMENT / ANTIHAFTBESCHICHTUNG					NINGUNO / NONE / AUCUN / KEINE
MANGO / HANDLE / QUEUE / GRIFF	INOXIDABLE / ST/STEEL / INOXYDABLE / ROSTFREI	INOXIDABLE / ST/STEEL / INOXYDABLE / ROSTFREI	INOXIDABLE / ST/STEEL / INOXYDABLE / ROSTFREI	COOL HANDLE®	HIERRO / FLAT IRON / FER / EISEN
RECOMENDADA / RECOMMENDED / RECOMMANDÉE / EMPFEHLUNG	ALTA RESISTENCIA A LA ABRASIÓN / HIGH RESISTANCE TO ABRASION / HAUTE RÉSISTANCE À L'ABRASION / HOHE RESISTENZ GEGEN VERSCHLEISS	ALTA RESISTENCIA A LA ABRASIÓN / HIGH RESISTANCE TO ABRASION / HAUTE RÉSISTANCE À L'ABRASION / HOHE RESISTENZ GEGEN VERSCHLEISS	COCCIÓN A FUEGO LENTO / SLOW BAKING / CUISSON À FEU LENT / KOCHEN MIT KLEINER FLAMME	RESISTENCIA PROFESIONAL / PROFESSIONAL STRENGTH / DURETÉ PROFESSIONNEL / PROFESSIONELLE RESISTENZ	SELLAR, FREIR, DORAR / SEALING, FRYING, BROWNING / CULOTTAGE, FRIRE ET DORER / ANBRATEN, FRITIERN, ANBRÄUNEN



# FOODIES

PUJADAS 1921	BLACK SERIES	MULTIMETAL	IDEA	APARTAMENTO
				
				
€€	€€	€€€€	€€	€
2 mm	4 mm	3,5 mm	0,7 mm	2,5 mm
				ANTIADHERENTE / NON-STICK / ANTI-ADHÉSIF / ANTIHAFT
INOXIDABLE / ST/STEEL / INOXYDABLE / ROSTFREI	INOXIDABLE / ST/STEEL / INOXYDABLE / ROSTFREI	INOXIDABLE / ST/STEEL / INOXYDABLE / ROSTFREI	INOXIDABLE / ST/STEEL / INOXYDABLE / ROSTFREI	BAQUELITA / BAKELITE / BAKÉLITE / BAKELITE
ALTAS TEMPERATURAS / HIGH TEMPERATURES HAUTES TEMPERATURES / HOHE TEMPERATUREN	ROBUSTEZ Y BUEN DESILIZAMIENTO / ROBUSTNESS AND GOOD SLIDING / ROBUSTESSE ET BON GLISSEMENT / ROBUSTHEIT UND GUTES RUTSCHEN	HOMOGENEIDAD Y EFICACIA TÉRMICA / HOMOGENEITY AND THERMAL EFFECTIVENESS / HOMOGÉNÉITÉ ET EFFICACITÉ THERMIQUE / HOMOGENITÄT UND WÄRMEFFIZIENZ	RESISTENCIA PROFESIONAL / PROFESSIONAL STRENGTH / DURETÉ PROFESSIONNEL / PROFESSIONELLE RESISTENZ	RESISTENCIA PROFESIONAL / PROFESSIONAL STRENGTH / DURETÉ PROFESSIONNEL / PROFESSIONELLE RESISTENZ



ALUMINIO / ALUMINIUM



ESPAÑOL

FABRICADAS EN ALUMINIO CON RECUBRIMIENTO ANTIADHERENTE, ADAPTADAS A TODO TIPO DE COCINAS EXCEPTO INDUCCIÓN. NO APTAS PARA HORNOS.

ENGLISH

MADE OF ALUMINIUM WITH NON-STICK COATING, SUITABLE FOR ANY KIND OF STOVE EXCEPT INDUCTION AND OVEN.

FRANÇAIS

FABRIQUÉES EN ALUMINIUM AVEC REVÊTEMENT ANTI-ADHÉSIF, RECOMMANDÉES POUR TOUT TYPE DE FEUX, SAUF INDUCTION. NE PAS UTILISER AUX FOURS.

DEUTSCH

HERSTELLUNG AUS ALUMINIUM MIT ANTIHAFTBESCHICHTUNG, ANGEPASST AN ALLE KOCHARTEN AUSSCHLIESSLICH INDUKTION UND OFEN.

ANTIADHERENTE / NON-STICK COATING / ANTI-ADHÉSIF/ ANTIHAFTBESCHICHTUNG

**P120** Sartén antiadherente "ERGOS" / Non-stick fry pan "ERGOS" / Poêle anti-adhésive "ERGOS" / Antihaft Bratpfanne "ERGOS"



Fácil limpieza / Easy to clean / Facile à nettoyer / Einfaches Reinigen



4 mm



Fondo plano  
Plain base  
Fond plain  
Glatter Unterboden

REF	Ø cm	H cm	U
P120.018	18	4,0	12
P120.020	20	4,0	12
P120.022	22	4,5	12
P120.024	24	4,5	6
P120.026	26	5,0	6
P120.028	28	5,0	6
P120.032	32	5,5	6
P120.036	36	6,0	6
P120.040	40	6,5	6

**P128** Sartén antiadherente "HERCULES" / Non-stick fry pan "HERCULES" / Poêle anti-adhésive "HERCULES" / Antihaft Bratpfanne "HERCULES"



Fácil limpieza / Easy to clean / Facile à nettoyer / Einfaches Reinigen



4 mm



Fondo plano  
Plain base  
Fond plain  
Glatter Unterboden

REF	Ø cm	H cm	U
P128.018	18	4,0	12
P128.020	20	4,0	12
P128.022	22	4,5	12
P128.024	24	4,5	6
P128.026	26	5,0	6
P128.028	28	5,0	6
P128.032	32	5,5	6
P128.036	36	6,0	6
P128.040	40	6,5	6

**P128** Sartén antiadherente "HERCULES" mango colores / Non-stick FRY PAN "HERCULES" Coloured handles / Poêle anti-adhésif "HERCULES" Queue à couleurs / Antihaft Bratpfanne "HERCULES" farbige Griffe



REF	ROJO/RED ROUGE/ROT	AMARILLO/YELLOW JAUNE/GELB	AZUL/BLUE BLEU/BLAU	VERDE/GREEN VERT/GRÜN	Ø cm	H cm	U
P128	1	2	3	4	20	4,0	1
P128	1	2	3	4	24	4,5	1
P128	1	2	3	4	28	5,0	1
P128	1	2	3	4	32	5,5	1

- Carnes rojas / Red meat / Viande rouge / Rotes Fleisch
- Carnes blancas y huevos / White meat and eggs / Volaille et oeufs / Weisses Fleisch und Eier
- Pescado / Fish / Poisson / Fisch
- Verdura / Vegetables / Legumes / Gemüse

Ref: P128 + (Color / Colour / Couleur / Farbe) + Ø

**P140** Sartén antiadherente "ERGOS TITANIUM" /  
Non-stick FRY PAN "ERGOS TITANIUM" /  
Poêle anti-adhésive "ERGOS TITANIUM" /  
Antihaft Bratpfanne "ERGOS TITANIUM"

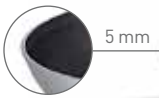

Fondo torneado /  
Ground base /  
Fond dressé /  
Gedrechselter  
Unterboden



Antiadherente / Non-stick  
Anti-adhésif / Antihaft

REF	Ø cm	H cm	U
P140.018	18	4,0	1
P140.020	20	4,0	1
P140.024	24	4,5	1
P140.028	28	5,0	1
P140.032	32	5,5	1
P140.036	36	6,0	1
P140.040	40	6,5	1

**P127** Sartén "ERGOS" expert /  
Fry pan "ERGOS" expert /  
Poêle "ERGOS" expert /  
Bratpfanne "ERGOS" Expert



REF	Ø cm	H cm	U
P127.024	24	4,5	1
P127.028	28	5,0	1
P127.032	32	5,5	1
P127.036	36	6,0	1
P127.040	40	6,5	1

**P148** Sartén honda "ERGOS" antiadherente /  
Non-stick sauté pan "ERGOS" /  
Sauteuse évasée en anti-adhésive "ERGOS" /  
Antihaft tiefe Bratpfanne "ERGOS"



**NUEVO MODELO /  
NEW MODEL /  
NOUVEAU MODÈLE /  
NEUES MODELL**



REF	Ø cm	H cm	U
P148.020	20	6,5	1
P148.024	24	7,0	1
P148.028	28	7,5	1
P148.032	32	8,0	1

**P124** Paellera antiadherente /  
Non-stick paella pan /  
Plat à paella anti-adhésif /  
Paellapfanne Antihaft



Asas de acero inox /  
St/Steel handle /  
Anses en acier inox /  
Griffe aus rostfreiem Stahl



REF	Ø cm	H cm	U
P124.020	20	4,0	1
P124.024	24	4,5	1
P124.028	28	5,0	1
P124.032	32	5,5	1
P124.036	36	6,0	1
P124.040	40	6,5	1

**P125** Sartén pescado "ERGOS" antiadherente /  
Non-stick FRY pan for fish "ERGOS" /  
Poêle à poisson "ERGOS" anti-adhésive /  
Antihaft Fischbratpfanne "ERGOS"



REF	cm	H cm	U
P125.038	38 x 26	5,0	1

**P131** Sartén para crêpes "HERCULES" antiadherente /  
Non-stick crêpe fry pan "HERCULES" /  
Poêle à crêpes "HERCULES" anti-adhésive /  
Crêpepfanne "HERCULES" Antihaft



REF	Ø cm	H cm	U
P131.022	22	2,5	12
P131.026	26	2,5	12



**P139** Sartén para blinis antiadherente / Non-stick blinis fry pan /  
Poêle à blinis anti-adhésive / Bratpfanne für Blinis Antihaft



REF	Ø cm	H cm	U
P139.012	12	2,0	36

**IDEA!**

Especial para huevo frito /  
Specially for fried egg /  
Spécialement pour œuf frit /  
Speziell für Spiegeleier

**P1208** Sartén con antiadherente cerámico / Fry pan with ceramic non-stick coating /  
Poêle à revêtement anti-adhésif céramique / Bratpfanne mit keramischer Antihaftbeschichtung



REF	Ø cm	H cm	U
P120.820	20	4,0	12
P120.824	24	4,5	6
P120.828	28	5,0	6
P120.832	32	5,5	6

Fondo chapa inox. inducción  
St/Steel sheet induction bottom  
Fond plaque inox. induction  
Rostfreier Stahlblechunterboden Induktion



**P1209** Sartén antiadherente fondo inducción "ERGOS" / Non-stick induction fry pan "ERGOS" /  
Poêle anti-adhésive fond induction "ERGOS" / Bratpfanne Antihaft Induktion "ERGOS"



ANTIADHERENTE / NON-STICK COATING /  
ANTI-ADHÉSIF / ANTIHAFTBESCHICHTUNG



REF	Ø cm	H cm	U
P120.920	20	4,0	12
P120.924	24	4,5	6
P120.928	28	5,0	6
P120.932	32	5,5	6

Fondo chapa inox. inducción  
St/Steel sheet induction bottom  
Fond plaque inox. induction  
Rostfreier Stahlblechunterboden Induktion



**P1289** Sartén antiadherente fondo inducción "HERCULES" / Non-stick induction fry pan "HERCULES" /  
Poêle anti-adhésive fond induction "HERCULES" / Bratpfanne Antihaft Induktion "HERCULES"



ANTIADHERENTE / NON-STICK COATING /  
ANTI-ADHÉSIF / ANTIHAFTBESCHICHTUNG



REF	Ø cm	H cm	U
P128.920	20	4,0	12
P128.924	24	4,5	6
P128.928	28	5,0	6
P128.932	32	5,5	6

Fondo chapa inox. inducción  
St/Steel sheet induction bottom  
Fond plaque inox. induction  
Rostfreier Stahlblechunterboden Induktion



VER PRODUCTOS EN / SEE PRODUCTS ON / VOIR PRODUITS EN PAGE / SIEHE PRODUKTE IN

**Antialérgico / Allergen - free / Anti allergique / Anti allergie**

Sarten antiadherente Wear - Ever® / Wear - Ever® non - stick fry pan /  
Poele anti - adhesive Wear-Ever® / Antiharft Wear-Ever® Bratpfanne

P. 84





ESPAÑOL

FABRICADAS EN ACERO INOXIDABLE 18/10, ADAPTADAS A TODO TIPO DE COCINAS INCLUIDAS LA DE INDUCCIÓN.

ENGLISH

MADE OF 18/10 ST/STEEL. SUITABLE FOR ANY KIND OF STOVES, INCLUDING INDUCTION.

FRANCAIS

FABRIQUÉE EN ACIER INOXYDABLE 18/10. RECOMMANDÉES POUR TOUT TYPE DE FEUX, ET COMPRIS INDUCTION.

DEUTSCH

HERGESTELLT AUS ROSTFREIEM STAHL 18/10. GEEIGNET FÜR ALLE KÜCHEN INKLUSIVE INDUKTION.

## P220 Sartén antiadherente excalibur "ERGOS" / Non-stick "ERGOS" excalibur fry pan / Poêle anti-adhésive excalibur "ERGOS" / Bratpfanne Antihaft excalibur "ERGOS"



**CLASS**  
**INDUCTION**

Fondo sandwich  
Sandwich bottom  
Fond sandwich  
Sandwichboden



REF	Ø cm	H cm	U
P220.018	18	3,5	1
P220.020	20	3,8	1
P220.022	22	4,2	1
P220.024	24	4,6	1
P220.026	26	5,0	1
P220.028	28	5,5	1
P220.032	32	6,0	1
P220.036	36	6,0	1
P220.040	40	6,5	1

ANTIADHERENTE / NON-STICK COATING /  
ANTI-ADHÉSIF / ANTIHAFTBESCHICHTUNG



**P2208** Sartén antiadherente cerámico / Fry pan with ceramic non-stick coating /  
Poêle revêtement anti-adhésif céramique / Bratpfanne keramische Antihftbeschichtung



**CLASS**  
**INDUCTION**



REF	Ø cm	H cm	U
P220.820	20	3,8	1
P220.824	24	4,6	1
P220.828	28	5,5	1
P220.832	32	6,0	1
P220.836	36	6,0	1
P220.840	40	6,5	1

ANTIADHERENTE /  
NON-STICK COATING /  
ANTI-ADHÉSIF /  
ANTIHAFTBESCHICHTUNG



**P213** Sartén "EXPERT" / "EXPERT" fry pan / Poêle "EXPERT" / Bratpfanne "EXPERT"



**CLASS**  
**INDUCTION**

Fondo sandwich  
Sandwich base  
Fond sandwich  
Sandwichboden



REF	Ø cm	H cm	U
P213.018	18	3,5	1
P213.020	20	3,8	1
P213.022	22	4,2	1
P213.024	24	4,6	1
P213.026	26	5,0	1
P213.028	28	5,5	1
P213.032	32	6,0	1
P213.036	36	6,0	1
P213.040	40	6,5	1

**P2393** Wok fondo redondo / Round base wok / Wok à fond rond / Wok mit rundem Boden



**CLASS**  
**INDUCTION**



REF	Ø cm	H cm	Lts	U
P239.336	36	10,0	6,00	1

**P2392** Wok fondo plano / Flat base wok / Wok à fond plain / Wok mit flachem Boden



**CLASS**  
**INDUCTION**



REF	Ø cm	H cm	Lts	U
P239.236	36	9,0	5,50	1



INDUCTION



ESPAÑOL

FABRICADAS EN ACERO CON EXCELENTES PROPIEDAS TÉRMICAS Y ANTIADHERENTES NATURALES. APTAS PARA HORNOS.  
LIMPIEZA: NO ES NECESARIO UTILIZAR NINGÚN TIPO DE JABÓN O AGUA. ES SUFICIENTE, FROTAR SUAVEMENTE CON UN PAÑO  
HUMEDECIDO CON ACEITE.

ENGLISH

MADE OF CARBON STEEL WITH EXCELLENT THERMAL AND NATURAL NON-STICK PROPERTIES. FLASH OVEN BAKING  
POSSIBLE.  
CLEANING: AVOID SOAP OR WATER, JUST WIPE THEM WITH AN OILED TISSUE OR CLOTH.

FRANÇAIS

FABRIQUÉES EN ACIER OFFRANT D'EXCELLENTE PROPRIÉTÉS THERMIQUES ET ANTIADHÉSIVES NATURELLES. APTE POUR  
UTILISATION EN FOUR.  
NETTOYAGE : EVITER LE SAVON ET L'EAU. UNIQUEMENT FROTTER DOUCEMENT AVEC UN CHIFFON IMBIBÉ D'HUILE.

DEUTSCH

HERGESTELLT AUS STAHL MIT EXZELLENTE THERMISCHEN EIGENSCHAFTEN UND NATÜRLICHER ANTIHAFTBESCHICHTUNG.  
GEEIGNET FÜR ÖFEN.  
REINIGUNG: KEIN GEBRAUCH VON SPÜLMITTEL ODER WASSER NÖTIG. MIT EINEM GEÖLTEN TUCH AUSREIBEN, REICHT AUS.

### P1351 Sartén "Lionesa" 1,5 mm / "Lyonnaise" Steel fry pan 1,5 mm / Poêle "Lyonnaise" 1,5 mm / Bratpfanne "Lyoner" 1,5 mm



REF	Ø cm	H cm	U
P135.120	20	4,5	1
P135.124	24	5,0	1
P135.128	28	5,5	1
P135.132	32	6,0	1
P135.136	36	6,5	1
P135.140	40	7,0	1

### P1353 Wok / Wok / Wok / Wok



REF	Ø cm	H cm	U
P135.330	30	9,5	1

### P1354 Sartén para crêpes / Crêpe fry pan / Poêle à crêpes / Crêpesbratpfanne



REF	Ø cm	H cm	U
P135.424	24	2,0	1

PAELLERA / SPANISH PAELLA PAN / PLAT À PAELLA / PAELLAPFANNE

**P994** Paellera valenciana en acero pulido / Black steel spanish paella pan / Plat à paella tôle acier / Spanische Paellapfanne aus poliertem Stahl



REF	Ø cm	RACIONES / PORTIONS PORTIONEN	U
P994.020	20	1	1
P994.022	22	1	1
P994.024	24	1	1
P994.026	26	2	1
P994.030	30	4	1
P994.032	32	5	1
P994.034	34	6	1
P994.036	36	7	1
P994.038	38	8	1
P994.040	40	9	1
P994.042	42	10	1
P994.046	46	12	1
P994.050	50	14	1
P994.055	55	16	1
P994.065	65	22	1
P994.080	80	40	1
P994.090	90	50	1

**P995** Paellera acero esmaltado / Enamelled steel paella pan / Plat à paella acier émaillé / Paellapfanne aus emailliertem Stahl



REF	Ø cm	RACIONES / PORTIONS PORTIONEN	U
P995.010 *	10	-	1
P995.016 *	15	-	1
P995.020	20	2	1
P995.026	26	2	1
P995.030	30	4	1
P995.034	34	6	1
P995.036	36	7	1
P995.038	38	8	1
P995.040	40	9	1
P995.042	42	10	1
P995.050	50	14	1
P995.060	60	19	1

\*MINI-SIZE



Ideal para tapas  
Recommended for snacks  
Recommandé pour tapas  
Ideal für Snacks

**P997** Sartén honda esmaltada con asas / Deep enamelled fry pan with handles / Poêle haute avec anses / Tiefe Paellapfanne aus emailliertem Stahl mit Griffen



REF	Ø cm	Lts	U
P997.014 *	14	0,40	1
P997.016 *	16	0,50	1
P997.028	28	3,90	1
P997.032	32	5,30	1
P997.036	36	7,80	1
P997.040	40	9,40	1

\*MINI-SIZE



Ideal para tapas  
Recommended for snacks  
Recommandé pour tapas  
Ideal für Snacks



**P998** Paellero esmaltado gas / Enamelled gas burner / Brûleur émaillé / Emailierter Gasbrenner



REF	Ø cm	CIRCULOS / CIRCLES / CERCLES / KREIS	Kw	U
P998.035	35	2	9,4	1
P998.050	50	2	14,1	1
P998.070	70	3	24,1	1

Válido para gas butano y propano NO para gas ciudad  
Valid only for gas butane and propane  
Valable uniquement pour gaz butane et propane /  
Geeignet nur für Butan- und Propangas

Ref. P998.035

Para paelleras de 20 a 50 cm Ø  
For paella pans from Ø 20 to 50 cm  
Pour plats à paella de 20 à 50 cm Ø  
Für Paellapfannen von 20 bis 50 cm Ø

Ref. P998.050

Para paelleras de 36 a 70 cm Ø  
For paella pans from Ø 36 to 70 cm  
Pour plats à paella de 36 à 70 cm Ø  
Für Paellapfannen von 36 bis 70 cm Ø

Ref. P998.070

Para paelleras de 36 a 90 cm Ø  
For paella pans from Ø 36 to 90 cm  
Pour plats à paella de 36 à 90 cm Ø  
Für Paellapfannen von 36 bis 90 cm Ø

**P999** Trípode paellero / Base for burner / Pied pour brûleur / Dreifussständer für Gasbrenner



REF	U
P999.000	1

Plegable apto para paelleros de 2 y 3 círculos  
Folding valid for 2 and 3 circles burners  
Pliant valable pour brûleurs de 2 et 3 cercles /  
Klappbar geeignet für 2 bis 3 Kreisgasbrenner

**COOKWARE  
PASSION &  
MEDITERRANEAN**



**NOTHING LESS,  
NOTHING MORE**

SelfCookingCenter  
with efficiency

0 1



The control panel features a digital display with several icons and settings. At the top, there are three icons: a blue one with a flame, a red one with a flame, and a white one with a flame. Below these, the display shows '100 %' with a horizontal slider bar. Underneath, it shows '160 °C' with another horizontal slider bar. Further down, it displays '01:38 min' with a clock icon and a '7' icon. At the bottom of the panel, there are several small icons including a clock, a question mark, and a right-pointing arrow. The time '11:02' is visible in the bottom left corner.



efficiency

**P269** Rustidera / Rost Pan / Plaque à rôtir / Bräter

INOX - ST/STEEL  
EDELSTAHL  
18/10



REF	cm	H cm	Lts	U
P269.035	35 x 27	5,5	5,00	1

**P309** Rustidera asas móviles / Roast pan falling handles /  
Plaque à rôtir anses tombantes /  
Bräter mit beweglichen Griffen

INOX - ST/STEEL  
EDELSTAHL  
18/10



REF	cm (int)	cm (ext)	H cm	Lts	U
P309.035	35 x 27	37,5 x 29,5	5,5	5,20	1
P309.040	40 x 30	43 x 33	6,5	6,50	1
P309.050	50 x 35	54 x 39	7,0	11,00	1
P309.060	60 x 40	64 x 44	9,0	19,00	1
P309.070	70 x 45	74 x 49	10,0	27,00	1

**BLACK ELEGANCE**

Rustidera aluminio presentación antiadherente /  
Non-stick presentation aluminium roast pan /  
Plaque à rôtir anti-adhésive présentation /  
Bräter Antihaft Aluminiumpräsentation

**P1145**

ALUMINIO /  
ALUMINIUM



REF	cm	H cm	Lts	U
P114.540	40 x 30	6,5	6,30	1
P114.545	45 x 32	6,5	7,60	1
P114.550	50 x 35	7,0	10,80	1

Rustidera antiadherente asas móviles /  
Non-stick roast pan falling handles /  
Plaque à rôtir anti-adhésive anses tombantes /  
Bräter mit beweglichen Griffen

**P122**

ALUMINIO /  
ALUMINIUM



REF	cm	H cm	Lts	U
P122.040	40 x 30	6,5	6,30	1
P122.050	50 x 35	7,0	10,80	1
P122.060	60 x 40	9,0	19,00	1

Rustidera asas fijas /  
Roast pan fixed handles /  
Plaque à rôtir avec poignées fixes /  
Bräter mit festen Griffen

**P114**

ALUMINIO /  
ALUMINIUM



REF	cm	H cm	Lts	U
P114.040	40 x 30	6,5	6,30	1
P114.045	45 x 32	6,5	7,60	1
P114.050	50 x 35	7,0	10,80	1
P114.060	60 x 40	9,0	19,00	1
P114.070	70 x 45	10,0	27,70	1

Rustidera asas móviles /  
Roast pan falling handles /  
Plaque à rôtir anses tombantes /  
Bräter mit beweglichen Griffen

**P113**

ALUMINIO /  
ALUMINIUM



REF	cm	H cm	Lts	U
P113.030	30 x 23	5,0	3,00	1
P113.035	35 x 27	5,5	5,00	1
P113.040	40 x 30	6,5	6,30	1
P113.045	45 x 32	6,5	7,60	1
P113.050	50 x 35	7,0	10,80	1
P113.055	55 x 40	8,0	15,50	1
P113.060	60 x 40	9,0	19,00	1
P113.065	65 x 45	10,0	25,70	1
P113.070	70 x 45	10,0	27,70	1

## BANDEJAS GASTRONORM / GASTRONORM TRAYS / PLAQUES GASTRONORME / GASTRONOMTABLETTS

**P3180**Bandeja gastronorm /  
Gastronorm sheet /  
Plaque gastronorme /  
GastronormtablettINOX - ST/STEEL  
EDELSTAHL  
18/10Grosor: 1 mm  
Thickness: 1 mm  
Épaisseur: 1 mm  
Dicke: 1 mm

REF	TIPO / TYPE	mm	H mm	U
P318.005	1/1	530 x 325	8,0	1

**P3182**Bandeja honda gastronorm /  
Deep gastronorm sheet /  
Plaque gastronorme fonde /  
Tiefes GastronormtablettINOX - ST/STEEL  
EDELSTAHL  
18/10Grosor: 0,7 mm  
Thickness: 0,7 mm  
Épaisseur: 0,7 mm  
Dicke: 0,7 mm

REF	TIPO / TYPE	mm	H mm	U
P318.211	1/1	530 x 325	20,0	1

**P1323**Bandeja GN antiadherente /  
Non-stick GN pan tray /  
Plaque GN anti-adhésive /  
Antihaft Tablett GNALUMINIO /  
ALUMINIUMGrosor = 3 mm  
Thickness = 3 mm  
Épaisseur = 3 mm  
Dicke: 3 mm

REF	TIPO / TYPE	H mm	Lts	U
P132.365	1/1	65,0	7,90	1

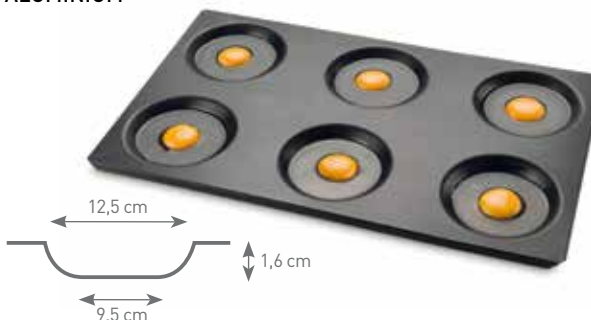
**P1325**Bandeja multiunidades /  
Multi-units tray /  
Plaque multi-unités /  
Multieinheiten TablettALUMINIO /  
ALUMINIUM

REF	TIPO / TYPE	mm	U
P132.560	1/1	530 x 325	1

## BANDEJAS PASTELERÍA / PASTRY TRAYS / PLAQUES À PÂTISSERIE / PATISSERIETABLETT

**P318**Bandeja pastelería / Baking sheet /  
Plaque à pâtisserie / PatisserietablettINOX - ST/STEEL  
EDELSTAHL  
18/10Grosor: 1 mm  
Thickness: 1 mm  
Épaisseur: 1 mm  
Dicke: 1 mm

REF	mm	H mm	U
P318.040	400 x 300	12,0	1
P318.060	600 x 400	12,0	1

**P779**Bandeja pastelería / Baking sheet /  
Plaque à pâtisserie / PatisserietablettINOX - ST/STEEL  
EDELSTAHL  
18/10Grosor: 0,7 mm  
Thickness: 0,7 mm  
Épaisseur: 0,7 mm  
Dicke: 0,7 mm

REF	mm	H mm	U
P779.017	255 x 175	10,0	1
P779.021	275 x 210	10,0	1
P779.026	300 x 260	10,0	1
P779.060	600 x 200	10,0	1



**P777** Marcos para bandejas escuadradas /  
Rectangle for bakin sheets /  
Rectangle pour plaques /  
Rahmen für rechteckige Backbleche

INOX - ST/STEEL  
EDELSTAHL  
18/10



Marcos adaptables a las bandejas escuadradas de la ref. P778, P1232 y P1322  
Rectangles that are adptable to the baking sheets of ref. P778, P1232 and P1322  
Rectangles pour adapter aux plaques inox des réfs. P778, P1232 et P1322  
Rahmen geeignet für rechteckige Backbleche Art.Nr. P778, P1232 und P1322

REF	mm	H mm	U
P777.540	395 x 295	50,0	1
P777.548	475 x 305	50,0	1
P777.560	595 x 395	50,0	1

**P778** Bandeja escuadrada /  
Tray for confectionery /  
Plaque à pâtisserie /  
Rechteckiges Backblech

INOX - ST/STEEL  
EDELSTAHL  
18/10



REF	mm	H mm	U
P778.040	400 x 300	10,0	1
P778.048	480 x 310	10,0	1
P778.060	600 x 400	10,0	1

**P123** Bandeja para pastelería /  
Tray for confectionery /  
Plaque à pâtisserie /  
Patisserietablett

ALUMINIO /  
ALUMINIUM



REF	mm	H mm	U
P123.040	400 x 300	12,0	1
P123.060	600 x 400	12,0	1

**P1231** Bandeja perforada para pastelería /  
Perforated tray for confectionery /  
Plaque à pâtisserie perforée /  
Gelochtes Patisserietablett

ALUMINIO /  
ALUMINIUM



REF	mm	H mm	U
P123.140	400 x 300	12,0	1
P123.160	600 x 400	12,0	1

**P1232** Bandeja para pastelería /  
Tray for confectionery /  
Plaque à pâtisserie /  
Patisserietablett

ALUMINIO /  
ALUMINIUM



REF	mm	H mm	U
P123.240	400 x 300	12,0	1
P123.260	600 x 400	12,0	1

**P132** Bandeja pastelería antiadherente /  
Non-stick tray for confectionery /  
Plaque à pâtisserie anti-adhésive /  
Antihaft Patisserietablett

ALUMINIO /  
ALUMINIUM



REF	mm	H mm	U
P132.040	400 x 300	12,0	1
P132.060	600 x 400	12,0	1



## BANDEJAS PASTELERÍA / PASTRY TRAYS / PLAQUES À PÂTISSERIE / PATISSERIETABLETT

**P1321** Bandeja pastelería antiadherente perforada /  
Perforated non-stick tray for confectionery /  
Plaque à pâtisserie anti-adhésive perforée /  
Antihaft Patisserietablett gelocht

ALUMINIO /  
ALUMINIUM



REF	mm	H mm	U
P132.140	400 x 300	12,0	1
P132.160	600 x 400	12,0	1

**P1322** Bandeja pastelería antiadherente /  
Non-stick tray for confectionery /  
Plaque à pâtisserie anti-adhésive /  
Antihaft Patisserietablett

ALUMINIO /  
ALUMINIUM



REF	mm	H mm	U
P132.240	400 x 300	12,0	1
P132.260	600 x 400	12,0	1

## REJILLAS / GRIDS / GRILLES / ROSTE

**P9091** Rejilla gastronorm acero inox / St/Steel gastronorm grid /  
Grille acier inoxydable gastronorm / Rostfreier Gastronormrost



REF	TIPO / TYPE	mm	N. TRAVESAÑOS / N. CROSS-BARS / N. TRAVERSES / N. QUERSTÄBE	Ø mm TRAVESAÑOS / Ø mm CROSS-BARS / Ø mm TRAVERSES / Ø mm QUERSTÄBE	N. VARILLAS / N. WIRES / N. FILS / N. STÄBE	Ø mm VARILLAS / Ø mm WIRES / Ø mm FILS / Ø mm STÄBE	U
P909.121	2/1	650 x 530	3	5	32	2	1
P909.111	1/1	530 x 325	2	5	20	2	1

**P9092** Rejilla gastronorm con Rilsan blanco / White rilsan steel gastronorm grid /  
Grille gastronorm en acier et rilsan blanc / Gastronormrost mit weissem Rilsan



REF	TIPO / TYPE	mm	N. TRAVESAÑOS / N. CROSS-BARS / N. TRAVERSES / N. QUERSTÄBE	Ø mm TRAVESAÑOS / Ø mm CROSS-BARS / Ø mm TRAVERSES / Ø mm QUERSTÄBE	N. VARILLAS / N. WIRES / N. FILS / N. STÄBE	Ø mm VARILLAS / Ø mm WIRES / Ø mm FILS / Ø mm STÄBE	U
P909.221	2/1	650 x 530	3	5	22	5	1
P909.211	1/1	530 x 325	2	5	13	5	1

**P9093** Rejilla pastelería acero inox / St/Steel pastry grid /  
Grille pâtisserie acier inoxydable / Rostfreier Patisserieirost



REF	mm	N. TRAVESAÑOS / N. CROSS-BARS / N. TRAVERSES / N. QUERSTÄBE	Ø mm TRAVESAÑOS / Ø mm CROSS-BARS / Ø mm TRAVERSES / Ø mm QUERSTÄBE	N. VARILLAS / N. WIRES / N. FILS / N. STÄBE	Ø mm VARILLAS / Ø mm WIRES / Ø mm FILS / Ø mm STÄBE	U
P909.340	400 x 300	2	5	22	2	1
P909.360	600 x 400	3	5	29	2	1

**P9094** Rejilla pastelería reforzada acero inox / St/Steel reinforced pastry grid /  
Grille pâtisserie acier inoxydable renforcée / Rostfreier Patisserieirost verstärkt



REF	mm	N. TRAVESAÑOS / N. CROSS-BARS / N. TRAVERSES / N. QUERSTÄBE	Ø mm TRAVESAÑOS / Ø mm CROSS-BARS / Ø mm TRAVERSES / Ø mm QUERSTÄBE	N. VARILLAS / N. WIRES / N. FILS / N. STÄBE	Ø mm VARILLAS / Ø mm WIRES / Ø mm FILS / Ø mm STÄBE	U
P909.460	600 x 400	2	6	24	3	1

**P705**

Molde hondo pizza antiadherente / Non-stick deep pizza mould /  
Moule haute pizza anti-adhésif / Tiefes Antihaft Pizzablech



REF	Ø cm	H cm	U
P705.024	24	2,5	6
P705.028	28	2,5	6
P705.032	32	2,5	6

**P736**

Molde pizza antiadherente perforado /  
Perforated non-stick pizza mould /  
Moule à pizza anti-adhésif perforé /  
Gelochtes Antihaft Pizzablech

Ø 8 mm  
agujeros / holes /  
trous / löcher



REF	Ø cm	H cm	U
P736.030	30	1,3	6
P736.034	34	1,3	6

**P929**

Base pizza aluminio /  
Aluminium pizza pan /  
Plaque à pizza aluminium /  
Aluminium Pizzablech



REF	Ø cm	U
P929.025	25	1
P929.028	28	1
P929.030	30	1
P929.036	36	1
P929.040	40	1

**P949**

Base rejilla aluminio antiadherente para pizza /  
Non-stick aluminium pizza screen /  
Base maillée aluminium anti-adhésive pour pizza /  
Antihaft Pizzagitter Aluminium



REF	Ø cm	U
P949.025	25,5	1
P949.030	30,5	1
P949.035	35,5	1
P949.040	40,0	1

**P963**

Base rejilla aluminio para pizza /  
Aluminium pizza screen /  
Base maillée aluminium pour pizza /  
Pizzagitter Aluminium



REF	Ø cm	U
P963.025	25	1
P963.030	30,5	1
P963.035	35,5	1
P963.040	40,0	1

**P977** Soporte para bases pizza 15 niveles /  
Pizza pan rack 15 levels /  
Support pour plaques à pizza 15 niveaux /  
Ständer für Pizzableche 15 Ebenen



REF	cm	H cm	U
P977.015	30,5 x 30,5	70,0	1

Recomendado para Ref. P929 hasta Ø36 cm  
Suitable for item Code P929 up to Ø36 cm  
Recommandé pour Réf. P929 jusqu'au Ø36 cm  
Empfohlen für Ref. P929 bis Ø36 cm

**P972** Papel siliconado /  
Siliconized baking release papers /  
Papier siliconé anti-adhésif /  
Backpapier aus Silikon



REF	mm	unidades / unit	U
P972.060	600 x 400	500	1

Caja de 500 unidades. Siliconado por las dos caras. Múltiples usos.  
Gramaje 41 gr/m2. Resistente a la grasa. Color blanco.  
Set of 500 units both sides siliconized. Multiple uses.  
Grammage 41 gr/m2. Greaseproof. Bleached.  
Boîte de 500 unités. Deux faces siliconées. Multiples utilisations.  
Grammage 41 gr/m2. Résistant à la graisse. Couleur blanc.  
Kiste mit 500 Stück. Beidseitig mit Silikon. Mehrfacher Gebrauch.  
Gewicht 41 gr/m2. Resistent gegen Fett. Weiss.

**P833** Tapete de silicona / non-stick silicone mat /  
Toile de cuisson / Silikonmatte



REF	mm	U
P833.001	520 x 315	1
P833.002	585 x 385	1
P833.003	400 x 300	1

**P607** Pinza fuente horno / roast pan tong /  
Pince pour plaque à rôtir / Ofenblechzange



REF	L cm	U
P607.000	19	1

**P948** Pala pizza de aluminio / aluminium pizza peel /  
Pelle à enfourner en aluminium / Aluminium Pizzaschaufel



REF	PALA / PEEL / PELLE / SCHAUFEL CM	L cm	U
P948.066	31 x 35	66	1
P948.090	31 x 35	90	1
P948.132	31 x 35	132	1
P948.163	31 x 35	163	1





Cacillo monobloc /  
One piece ladle /

### P3011 Louche monobloc / Monoblock Schöpflöffel

Capacidad marcada en el mango /  
Capacity marked on the handle /  
Capacité marqué à la queue /  
Volumenangabe am Griff markiert



REF	Ø cm	L cm	Lts	U
P301.165	6,5	31	0,07	12
P301.108	8	32	0,13	12
P301.109	9	33	0,20	12
P301.110	10	37	0,25	6
P301.112	12	42	0,45	6
P301.114	14	43	0,75	6
P301.116	16	45	1,00	6
P301.118	18	48	1,50	6

Cacillo monobloc económico /  
Economical one piece ladle /

### P3012 Louche monobloc économique / Monoblock Schöpflöffel ökonomisch

Capacidad marcada en el mango /  
Capacity marked on the handle /  
Capacité marqué à la queue /  
Volumenangabe am Griff markiert



REF	Ø cm	L cm	Lts	U
P301.206	6	27	0,05	10
P301.208	8	31	0,12	10
P301.210	10	33	0,25	10
P301.212	12	36	0,42	10
P301.214	14	39	0,75	10
P301.216	16	43	1,20	10

Cacillo para salsas con 2 picos laterales /  
One piece sauce ladle with 2 spouts /

### P392 Cuillère à sauces monobloc avec 2 becs verseurs / Schöpflöffel für Sossen mit 2 seitlichen Ausgüssen

Capacidad marcada en el mango /  
Capacity marked on the handle /  
Capacité marqué à la queue /  
Volumenangabe am Griff markiert

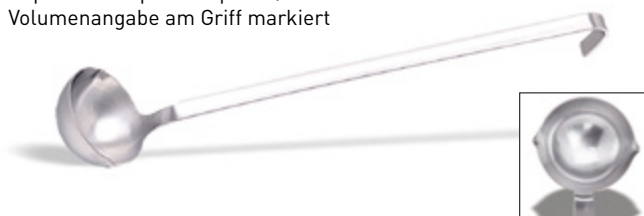

REF	Ø cm	L cm	Lts	U
P392.065	6,5	31	0,08	10

Cacillo monobloc mango corto /  
One piece ladle short handle /

### P30326 Louche monobloc manche court / Monoblock Schöpflöffel kurzer Stiel

Capacidad marcada en el mango /  
Capacity marked on the handle /  
Capacité marqué à la queue /  
Volumenangabe am Griff markiert



REF	Ø cm	L cm	Lts	U
P303.265	6,5	22	0,07	10

Cacillo monobloc con agujeros /  
Perforated one piece ladle /

### P396 Louche monobloc perforée / Gelochter Monoblock Schöpflöffel



REF	Ø cm	L cm	U
P396.009	9	33	10
P396.010	10	37	10
P396.012	12	42	10

VER PRODUCTOS EN / SEE PRODUCTS ON /  
VOIR PRODUITS EN PAGE / SIEHE PRODUKTE IN

ANTIALÉRGICO / ALLERGEN - FREE /  
ANTI ALLERGIQUE / ANTI ALLERGIE

Cacillo monobloc Kool-Touch® /  
One-Piece ladle Kool-Touch® handle /  
Louche monobloc manche Kool-Touch® /  
Monoblock Schöpflöffel  
Kool-Touch® Griffen



P. 85



**4980120**

Cacillo monobloc Kool-Touch® / One-Piece ladle Kool-Touch® handle /  
Louche monobloc manche Kool-Touch® / Monoblock Schöpflöffel Kool-Touch® Griffen



REF	Color	Ø cm	L cm	ml	U
4980120	Black	4,5	25,0	30	12
4980230	Blue	6,0	25,0	60	12
4980335	Yellow	7,5	32,0	90	12
4980445	Grey	8,5	32,0	120	12
4980655	Green	9,0	31,5	175	12
4980865	Orange	10,0	32,0	235	12



Revestimiento mango /  
Coated handle /  
Revêtement queue /  
Griffbeschichtung

**82 °C**

VER PRODUCTOS EN / SEE PRODUCTS ON /  
VOIR PRODUITS EN PAGE / SIEHE PRODUKTE IN

ERGOGRIP™

Cacillo / Ladle /  
Louche / Schöpflöffel



CATÁLOGO /  
CATALOGUE /  
CATALOGUE /  
KATALOG

VOLLRATH

P. 69

VER PRODUCTOS EN / SEE PRODUCTS ON /  
VOIR PRODUITS EN PAGE / SIEHE PRODUKTE IN

Utensilios buffet / Buffet utensils /  
Ustensiles de buffet / Buffetutensilien



CATÁLOGO /  
CATALOGUE /  
CATALOGUE /  
KATALOG

VOLLRATH

P. 110

**P3021**

Espumadera monobloc /  
One piece skimmer /  
Écumoire monobloc /  
Schaumlöffel Monoblock



REF	Ø cm	L cm	U
P302.108	8	29	10
P302.110	10	32	10
P302.112	12	35	10
P302.114	14	37	10
P302.116	16	44	5
P302.118	18	44	5
P302.120	20	47	5

**P3022**

Espumadera monobloc económica /  
Economical one piece skimmer /  
Écumoire monobloc économique /  
Schaumlöffel Monoblock ökonomisch



REF	Ø cm	L cm	U
P302.210	10	33	10
P302.212	12	36	10
P302.214	14	39	10
P302.216	16	42	10

**P3141**

Espátula monobloc sin perforar /  
One piece spatula /  
Spatule monobloc /  
Pfannenwender Monoblock



REF	cm	L cm	U
P314.110	10	36	5
P314.112	12	39	5

**P3142**

Espátula monobloc perforada /  
One piece perforated spatula /  
Spatule monobloc perforée /  
Gelochter Pfannenwender Monoblock



REF	cm	L cm	U
P314.210	10	36	5
P314.212	12	39	5

**P3143**

Pala pescado monobloc / One piece fish spatula / Pelle à poisson monobloc / Fischwender Monoblock



REF	cm	L cm	U
P314.300	16 x 12	42	5







# ANTIMICROBIAL

UTENSILIOS CON PROPIEDADES ANTIMICROBIALES NATURALES /  
 UTENSILS WITH NATURE'S ANTIMICROBIAL /  
 USTENSILES AVEC TRAITEMENT ANTIMICROBIEN /  
 SERVIERUTENSILIEN MIT NATUREIGENEM ANTIMIKROBIOTIKUM

ESPAÑOL

NO ES DIFÍCIL IMAGINARSE LA GRAN CANTIDAD DE MICROBIOS QUE PUEDEN TRANSFERIRSE A LOS UTENSILIOS DE SERVICIO, Y COMO LOS UTENSILIOS SUCIOS NO SON COMPATIBLES CON LA COMIDA, USTED NECESITA EL PODER DE LA EXCLUSIVA TECNOLOGÍA ANTIMICROBIANA AGION® CON IONES DE PLATA. MIENTRAS LOS MICROBIOS SE ACUMULAN Y MULTIPLICAN EN LAS SUPERFICIES SIN TRATAR, EN LOS UTENSILIOS ANTIMICROBIANOS ÉSTOS SON ATACADOS POR LOS IONES DE PLATA

ENGLISH

IT'S NOT HARD TO IMAGINE HOW MANY OF THESE NASTY MICROBES CAN GET TRANSFERRED TO SERVING UTENSILS, AND BECAUSE DIRTY UTENSILS AND FOOD DO NOT GET ALONG, YOU NEED THE POWER OF EXCLUSIVE ION ANTIMICROBIAL TECHNOLOGY. WHILE UNTREATED SURFACES ALLOW MICROBES TO COLLECT AND MULTIPLY, MICROBES ARE ATTACKED BY THE SILVER IONS IN ANTIMICROBIAL UTENSILS

FRANÇAIS

IL EST FACILE D'IMAGINER LE NOMBRE DE MICROBES NUISIBLES QUI PEUVENT ÊTRE TRANSFÉRÉS AUX USTENSILES DE CUISSON ET DE SERVICE, ET COMME LES USTENSILES SALES ET LES ALIMENTS NE FONT PAS BON MÉNAGE, UTILISEZ LE POUVOIR DE LA TECHNOLOGIE ANTIMICROBIENNE AUX IONS ARGENT AGION®. ALORS QUE LES SURFACES NON TRAITÉES PERMETTENT AUX MICROBES DE SE RASSEMBLER ET DE SE MULTIPLIER, LES IONS ARGENT DES USTENSILES ANTIMICROBIENS ATTAQUENT

DEUTSCH

ES IST NICHT SCHWIERIG, SICH DIE GROSSE MENGE AN MIKROBEN VORZUSTELLEN, DIE AUF SERVIERUTENSILIEN ÜBERTRAGEN WERDEN KÖNNEN. UND DA SICH SCHMUTZIGE UTENSILIEN MIT NAHRUNGSMITTELN NICHT VERTRAGEN, BENÖTIGEN SIE DIE EXKLUSIVE ENTMIKROBENTECHNOLOGIE AGION® MIT SILBERIONEN. WÄHREND SICH MIKROBEN AUF UNBEHANDELTEN OBERFLÄCHEN ANSAMMELN UND VERMEHREN KÖNNEN, WERDEN DIE AUF ANTIMIKROBIELLEN SERVIERUTENSILIEN VON DEN SILBERIONEN ANGEGRIFFEN.

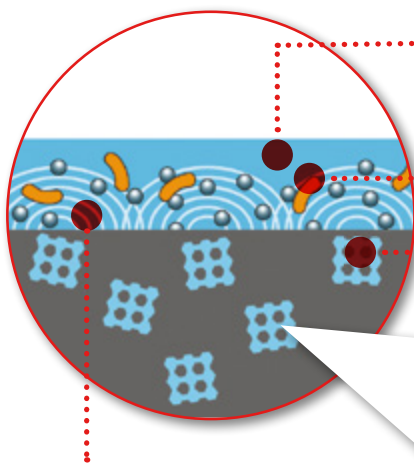

PELICULA SUPERFICIAL DE HUMEDAD /  
 SURFACE FILM OF MOISTURE /  
 FILM DE SURFACE DE L'HUMIDITÉ /  
 FEUCHTIGKEITSFILM AN DER OBERFLÄCHE

BACTERIA / BACTERIA /  
 BACTÉRIES / BAKTERIUM

MATERIAL DEL MANGO CON ZEOLITAS INCRUSTADAS /  
 HANDLE MATERIAL WITH EMBEDDED ANTIMICROBIAL ZEOLITES /  
 MATÉRIAU DE MANCHE AVEC ZÉOLITES INTÉGRÉES /  
 GRIFFMATERIAL MIT EINGEBETTETEN ZEOLITHEN

OLAS DE IONES DE PLATA ANTI-MICROBIANOS ATACANDO /  
 WAVES OF ANTIMICROBIAL SILVER IONS ATTACKING /  
 ONDES D'IONS ARGENT ANTI-MICROBIENS ATTAQUANT /  
 ANGRIFSWELLEN ANTIMIKROBIELLER SILBER-IONEN

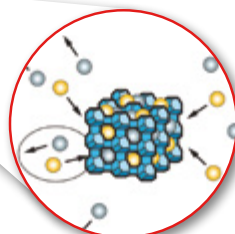

ZEOLITAS LIBERANDO IONES DE PLATA /  
 ANTIMICROBIAL ZEOLITE RELEASING SILVER IONS /  
 ZÉOLITES LIBÉRANT DES IONS ARGENT /  
 SILBER-IONEN FREISETZENDE ZEOLITHE



**JP**  
**JACOB'S PRIDE**  
 COLLECTION  
 GUARANTEED FOR LIFE



SPOODLE®

**MANGO CON DISEÑO ERGONÓMICO, DE NYLON QUE REDUCE LA FATIGA DURANTE SU USO. MAX TEMP 232 °C /**  
HANDLE WITH ERGONOMIC DESIGN, MADE FROM NYLON WHICH REDUCES WEAR DURING USE. MAXIMUM TEMPERATURE 232 °C /  
MANCHE AU DESIGN ERGONOMIQUE EN NYLON QUI RÉDUIT LA FATIGUE PENDANT SON EMPLOI. TEMP. MAX. 232 °C /  
GRIFF MIT ERGONOMISCHEM DESIGN AUS NYLON, WAS DEN VERSCHLEISS WÄHREND DER NUTZUNG REDUZIERT. MAX. TEMP. 232 °C

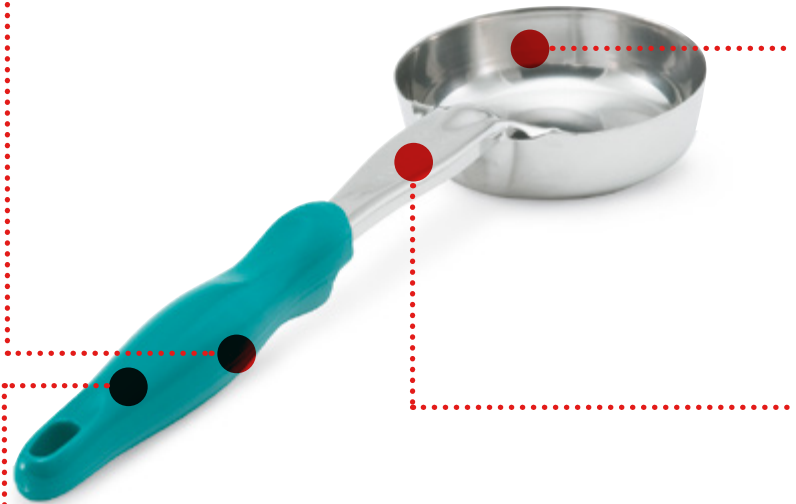

**MANGO Y PORCIONADORES DE ACERO INOXIDABLE BRILLANTE — RESISTENTE A LA CORROSIÓN /**  
MIRROR-FINISHED STAINLESS STEEL SHAFTS AND BOWLS — RESISTANT TO CORROSION /  
TIGES ET CUILLERONS EN ACIER INOXYDABLE ULTRA-BRILLANT — RÉSISTANT À LA CORROSION /  
STIEL UND HÖHLUNGEN AUS HOCHGLANZ-POLIERTEM EDELSTAHL – GEGEN KORROSION BESTÄNDIG

**CAPACIDAD MARCADA EN EL MANGO /**  
CAPACITY MARKED ON THE HANDLE /  
CAPACITÉ MARQUÉ À LA QUEUE /  
VOLUMENANGABE AM GRIFF MARKIER

COLOR / COLOR / COULEUR / FARBE	ml
Blue	60
Orange	90
Grey	120
Teal	175
Red	235

**EXCLUSIVO DISEÑO OVALADO, QUE PERMITE ACCEDER DE FORMA FÁCIL A LAS ESQUINAS DE LAS CUBETAS, MAXIMIZANDO EL APROVECHAMIENTO DEL CONTENIDO DEL RECIPIENTE /**  
UNIQUE OVAL BOWL DESIGN FITS INTO CORNERS OF STEAM TABLE PANS, REDUCING WASTE AND MAXIMIZING SERVING EFFICIENCY /  
DESIGN OVAL UNIQUE QUI PERMET D'ATTEINDRE TOUTS LES COINS DU BAG, TOUT EN REDUISANT LA QUANTITÉ DE DÉCHETS ET L'AUGMENTATION DE L'EFFICACITÉ DU SERVICE /  
EXKLUSIVES OVALES DESIGN, DAS ES ERLAUBT, GANZ EINFACH IN DIE ECKEN DES BEHÄLTERS ZU KOMMEN, SO DASS DER INHALT DES BEHÄLTERS MAXIMAL AUSGENUTZT WERDEN KANN



**SUPERFICIE TEXTURIZADA PARA IMPEDIR DERRAMES DURANTE EL USO /**  
TEXTURED SURFACE PREVENTS SLIPPAGE WHILE IN USE /  
LA SURFACE TEXTURÉE EMPÊCHE LA CUILLÈRE DE GLISSER DANS LE RÉCIPENT /  
TEXTURIERTE OBERFLÄCHE VERHINDERT EIN ABRUTSCHEN WÄHREND DES GEBRAUCHS



**MUESCA PARA IMPEDIR QUE EL CUCHARÓN SE DESLICE DENTRO DEL RECIPIENTE /**  
BUILT-IN STOPPER NOTCH PREVENTS UTENSILS FROM SLIDING INTO FOOD PRODUCT /  
ENCOCHE-BUTÉE INTÉGRÉE POUR EMPÊCHER LES USTENSILES DE GLISSER DANS LE PRODUIT ALIMENTAIRE /  
INTEGRIERTE KERBE VERHINDERT, DASS DIE UTENSILIEN IN DIE SPEISE HINEINRUTSCHEN /

### 6433230 Spoodle® monobloc redondo / One-Piece Round Spoodle® / Spoodle® monobloc ronde / Monoblok Rundschaalen Spoodle®



232 °C

REF	Color	Ø cm	L cm	ml	U
6433230	Blue	6,5	32	60	12
6433335	Orange	7,4	33	90	12
6433445	Grey	8,2	34	120	12
6433655	Green	9,3	35	175	12
6433865	Red	10,2	36	235	12

### 6432230 Spoodle® monobloc redondo perforado / One-Piece Round Perforated Spoodle® / Spoodle® monobloc ronde perforé / Monoblok Perforierten Rundschaalen Spoodle®



232 °C

REF	Color	Ø cm	L cm	ml	U
6432230	Blue	6,5	32	60	12
6432335	Orange	7,4	33	90	12
6432445	Grey	8,2	34	120	12
6432655	Green	9,3	35	175	12
6432865	Red	10,2	36	235	12

### 6433120 Spoodle® monobloc redondo / One-Piece Round Spoodle® / Spoodle® monobloc ronde / Monoblok Rundschaalen Spoodle®



Mango negro /  
Black handle /  
Manche noir /  
Schwarzen Griff



232 °C

REF	Ø cm	L cm	ml	U
6433120	5,2	31,0	30	12
6433220	6,5	32,0	60	12
6433320	7,4	33,0	90	12
6433420	8,2	34,0	120	12
6433520	8,8	34,5	150	12
6433620	9,3	35,0	175	12
6433820	10,2	36,0	235	12

### 6432120 Spoodle® monobloc redondo perforado / One-Piece Round Perforated Spoodle® / Spoodle® monobloc ronde perforé / Monoblok Perforierten Rundschaalen Spoodle®



Mango negro /  
Black handle /  
Manche noir /  
Schwarzen Griff



232 °C

REF	Ø cm	L cm	ml	U
6432120	5,2	31,0	30	12
6432220	6,5	32,0	60	12
6432320	7,4	33,0	90	12
6432420	8,2	34,0	120	12
6432520	8,8	34,5	150	12
6432620	9,3	35,0	175	12
6432820	10,2	36,0	235	12

VER PRODUCTOS EN / SEE PRODUCTS ON / VOIR PRODUITS EN PAGE / SIEHE PRODUKTE IN

## SPOODLE®

ANTIALÉRGICO / ALLERGEN - FREE /  
ANTI ALLERGIQUE / ANTI ALLERGIE

P. 85



**6412230** Spoodle® monobloc oval / One-Piece Oval Spoodle® /  
Spoodle® monobloc oval / Monoblok Ovalschalen Spoodle®



REF	Color	LxW cm	L cm	ml	U
6412230	Blue	7,5 x 6,8	33,0	60	12
6412335	Tan	8,5 x 7,8	34,0	90	12
6412445	Grey	9,4 x 8,6	35,0	120	12
6412655	Teal	10,7 x 9,8	36,5	175	12
6412865	Red	11,8 x 10,7	37,5	235	12

232 °C

**6422230** Spoodle® monobloc oval perforado / One-Piece oval Perforated Spoodle® /  
Spoodle® monobloc oval perforé / Monoblok Perforierten Ovalschalen Spoodle®



REF	Color	LxW cm	L cm	ml	U
6422230	Blue	7,5 x 6,8	33,0	60	12
6422335	Tan	8,5 x 7,8	34,0	90	12
6422445	Grey	9,4 x 8,6	35,0	120	12
6422655	Teal	10,7 x 9,8	36,5	175	12
6422865	Red	11,8 x 10,7	37,5	235	12

232 °C

**6412120** Spoodle® monobloc oval / One-Piece Oval Spoodle® /  
Spoodle® monobloc oval / Monoblok Ovalschalen Spoodle®



Mango negro /  
Black handle /  
Manche noir /  
Schwarzen Griff



REF	LxW cm	L cm	ml	U
6412120	6,0 x 5,5	31,5	30	12
6412220	7,5 x 6,8	33,0	60	12
6412320	8,5 x 7,8	34,0	90	12
6412420	9,4 x 8,6	35,0	120	12
6412520	10,1 x 9,2	36,0	150	12
6412620	10,7 x 9,8	36,5	175	12
6412820	11,8 x 10,7	37,5	235	12

232 °C

**6422120** Spoodle® monobloc oval perforado / One-Piece oval Perforated Spoodle® /  
Spoodle® monobloc oval perforé / Monoblok Perforierten Ovalschalen Spoodle®



Mango negro /  
Black handle /  
Manche noir /  
Schwarzen Griff



REF	LxW cm	L cm	ml	U
6422120	6,0 x 5,5	31,5	30	12
6422220	7,5 x 6,8	33,0	60	12
6422320	8,5 x 7,8	34,0	90	12
6422420	9,4 x 8,6	35,0	120	12
6422520	10,1 x 9,2	36,0	150	12
6422620	10,7 x 9,8	36,5	175	12
6422820	11,8 x 10,7	37,5	235	12

232 °C



MUESCA PARA IMPEDIR QUE EL CACILLO SE DESLICE DENTRO DEL RECIPIENTE

BUILT-IN STOPPER NOTCH PREVENTS UTENSILS FROM SLIDING INTO FOOD PRODUCT

ENCOCHE-BUTÉE INTÉGRÉE POUR EMPÊCHER LES USTENSILES DE GLISSER DANS LE PRODUIT ALIMENTAIRE

INTEGRIERTE KERBE VERHINDERT, DASS DIE UTENSILIEN IN DIE SPEISE HINEINRUTSCHEN

Spoodle® redondo nylon /  
Solid round Nylon Spoodle® Utensil /  
**5283520** Spoodle® nylon rond pleins hautes températures /  
Hochtemperaturbeständiges, Massiver rundes Nylon-Spoodle® Utensil



+ 245 °C



REF	Ø cm	L cm	ml	U
5283520	7,1	31,0	90	12
5283720	8,4	31,5	120	12
5283920	9,1	32,0	175	12

Spoodle® redondo perforado nylon /  
Perforated round Nylon Spoodle® Utensil /  
**5283620** Spoodle® nylon rond perforé hautes températures /  
Hochtemperaturbeständiges, perforierter rundes Nylon-Spoodle® Utensil



+ 245 °C



REF	Ø cm	L cm	ml	U
5283620	7,1	31,0	90	12
5283820	8,4	31,5	120	12
5284020	9,1	32,0	175	12

Spoodle® oval nylon /  
Solid oval Nylon Spoodle® Utensil /  
**5292620** Spoodle® nylon ovale pleins hautes températures /  
Hochtemperaturbeständiges, Massiver ovales Nylon-Spoodle® Utensil



+ 245 °C



REF	L cm	ml	U
5292620	31,0	90	12
5292820	31,5	120	12
5293320	32,0	175	12

Spoodle® oval perforado nylon /  
Perforated oval Nylon Spoodle® Utensil /  
**5292720** Spoodle® nylon ovale perforé hautes températures /  
Hochtemperaturbeständiges, perforierter ovales Nylon-Spoodle® Utensil



+ 245 °C



REF	L cm	ml	U
5292720	31,0	90	12
5292920	31,5	120	12
5293420	32,0	175	12



**P376** Cuchara monobloc profesional /  
Professional one piece spoon /  
Cuillère monobloc professionnelle /  
Professioneller Löffel Monoblock



REF	L cm	U
P376.037	37	10

**P3761** Cuchara honda monobloc profesional /  
Professional one piece deep spoon /  
Cuillère fonde monobloc professionnelle /  
Tiefer professioneller Löffel Monoblock



REF	L cm	U
P376.137	37	10

**P377** Cuchara perforada monobloc profesional /  
Professional one piece perforated spoon /  
Cuillère perforée monobloc professionnelle /  
Gelochter professioneller Löffel Monoblock



REF	L cm	U
P377.037	37	10

**P3771** Cuchara honda monobloc profesional perforada /  
Professional one piece perforated deep spoon /  
Cuillère fonde monobloc professionnelle perforée /  
Tiefer gelochter professioneller Löffel Monoblock



REF	L cm	U
P377.137	37	10

**P395** Cuchara oblicua monobloc /  
One piece crosswire spoon /  
Cuillère oblique monobloc /  
Sossenlöffel Monoblock



REF	L cm	U
P395.038	38	10

**P3972** Tenedor monobloc /  
One piece meat fork /  
Fourchette monobloc /  
Fleischgabel Monoblock



REF	L cm	U
P397.247	47	10

2 púas / 2 prongs / 2 dents / 2 Zinken

**P3973** Tenedor monobloc / One piece meat fork /  
Fourchette monobloc / Fleischgabel Monoblock



REF	L cm	U
P397.347	47	10

3 púas / 3 prongs / 3 dents / 3 Zinken

**P315** Espumadera de alambre / Mesh skimmer /  
Écumoire à friture / Drahtschaumlöffel



REF	Ø cm	L cm	U
P315.010	10	40	10
P315.012	12	43	10
P315.015	15	50	10
P315.017	17	54	10
P315.020	20	61,5	10

**P94101** Araña / Wire skimmer /  
Araignée / Schaumlöffel



REF	Ø cm	L cm	U
P941.013	13	47,5	10
P941.015	15	49,5	10
P941.018	18	52,5	10
P941.020	20	54,5	10
P941.022	22	67	5
P941.024	24	69	5
P941.028	28	69	5

**P955** Espumadera malla fina / Mesh skimmer /  
Écumoire maillée / Feiner Drahtschaumlöffel



REF	Ø cm	L cm	U
P955.010	10	40	10
P955.012	12	43	10
P955.015	15	50	10
P955.017	17	54	10
P955.020	20	61	10

Detalle de la malla a escala real  
Detail of the sieve at real scale  
Détail de la maille à échelle réelle  
Detail Maschen in realer Größe

**P394** Molde nido / Bird nest mould /  
Moule à nid / Vogelnestform

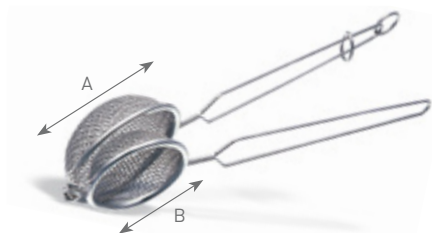

REF	Ø A cm	Ø B cm	U
P394.008	10	8	1
P394.012	12	10	1

VER PRODUCTOS EN / SEE PRODUCTS ON /  
VOIR PRODUITS EN PAGE / SIEHE PRODUKTE IN

Batidores / Whisks / Fouets / Rührbesen



P. 338

**64130** Cuchara servicio / Solid spoons /  
Cuillères à servir pleines / Massiv Löffel



REF	Color	L cm	U
64130	Black	35	12
6414015	White	35	12
6414030	Blue	35	12
6414040	Red	35	12
6414050	Yellow	35	12
6414070	Green	35	12

**64132** Cuchara servicio perforada / Perforated spoons /  
Cuillères à servir perforées / Perforiert Löffel

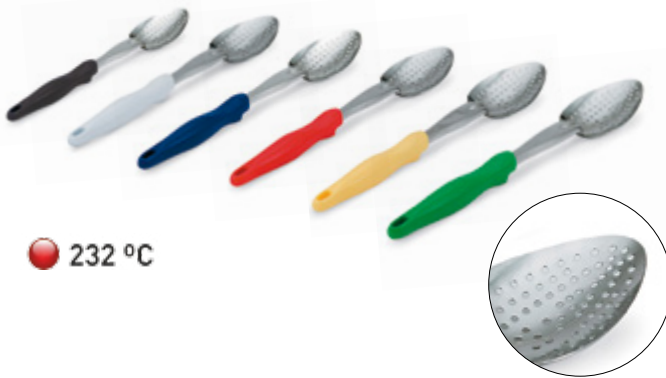

REF	Color	L cm	U
64132	Black	35	12
6414215	White	35	12
6414230	Blue	35	12
6414240	Red	35	12
6414250	Yellow	35	12
6414270	Green	35	12

**64134** Cuchara servicio ranurada / Slotted spoon /  
Cuillère à servir ajourée / Geschlitzt Löffel



REF	Color	L cm	U
64134	Black	35	12

**64136** Cuchara servicio lisa 3 lados / 3-Sided solid spoon /  
Cuillère à servir pleine, à trois côtés / 3-seitig, massiv Löffel



REF	Color	L cm	U
64136	Black	34	12

**64138** Cuchara servicio perforada lisa 3 lados / 3-Sided perforated spoon /  
Cuillère à servir perforée, à trois côtés / 3-seitig, perforiert Löffel



REF	Color	L cm	U
64138	Black	34	12

**5284220** Cuchara nylon / Nylon spoon / Cuillère nylon / Nylonlöffel

● + 245 °C

5284220



5284320



REF	Color	L cm	U
5284220	■	34	12
5284320	■	34	12

**4689760** Cuchara nylon para preparación / Nylon spoon for preparation /  
Cuillère nylon pour préparation / Nylonlöffel für die Zubereitung

● + 205°C



REF	Color	L cm	U
4689760	■	21,6	12
4689815	■	30,5	12
4689830	■	30,5	12
4689840	■	30,5	12
4689850	■	30,5	12
4689860	■	30,5	12
4689960	■	38,1	12

**47139** Porcionador / Thumb disher / Cuillère de service / Portionierer

REF	COLOR	Ø mm	Mlts	U
47139	○	6	157,7	12
47140	●	8	118,3	12
47141	●	10	96,1	12
47142	●	12	78,9	12
47143	●	16	59,1	12
47144	●	20	48,1	12
47145	●	24	39,4	12
47146	●	30	29,6	12

**47390** Porcionador apretable / Squeeze disher / Cuillère-pression de service / Eisportionierer

REF	COLOR	Ø mm	Mlts	U
47390	○	6	139	12
47391	●	8	110	12
47392	●	10	96	12
47393	●	12	84	12
47395	●	16	59	12
47396	●	20	53	12
47397	●	24	45	12
47398	●	30	33	12

VER PRODUCTOS EN / SEE PRODUCTS ON / VOIR PRODUITS EN PAGE / SIEHE PRODUKTE IN

HELADERÍA / ICE-CREAM UTENSILS /  
USTENSILES POUR GLACE / ZUBEHÖR FÜR EISCREME

Racionador de helado / Ice cream scoop / Cuillère à glace / Eiskugelportionierer

P. 330





**IDEA!**

Pinzas ideales para emplatar y decorar  
Plating tongs for careful lifting, turning and decorating  
Pincas idéales pour la présentation et la décoration  
Ideale Zangen Zum Anrichten und Dekorieren

**P3434** Pinza chef precisión extra larga (fina) / Extra long fine tip straight tweezer (narrow) /  
Pince du chef précision extra long (étroite) / Extra lange Präzisionspinzette (schmal)

INOX - ST/STEEL  
EDELSTAHL  
18/10

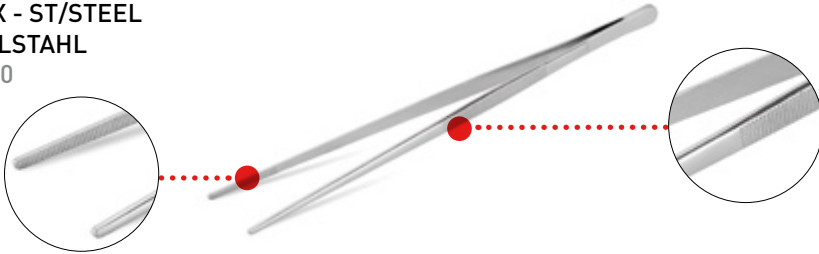

REF	L cm	U
P343.400	30	1

**P3435** Pinza chef precisión extra larga (ancha) / Extra long fine tip straight tweezer (wide) /  
Pince du chef précision extra long (large) / Extra lange Präzisionspinzette (breit)

INOX - ST/STEEL  
EDELSTAHL  
18/10

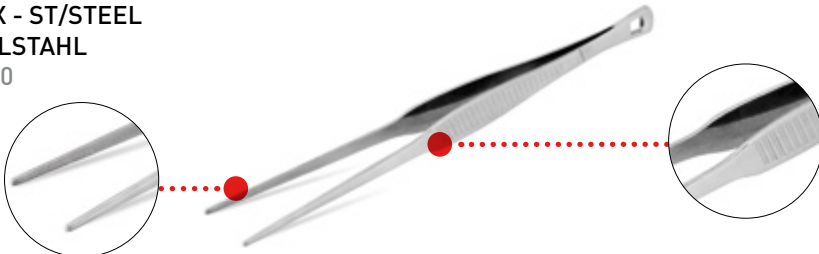

REF	L cm	U
P343.500	30	1

**P3436** Pinza chef precisión / Fine tip straight tweezer /  
Pince du chef précision / Präzisionspinzette

INOX - ST/STEEL  
EDELSTAHL  
18/10

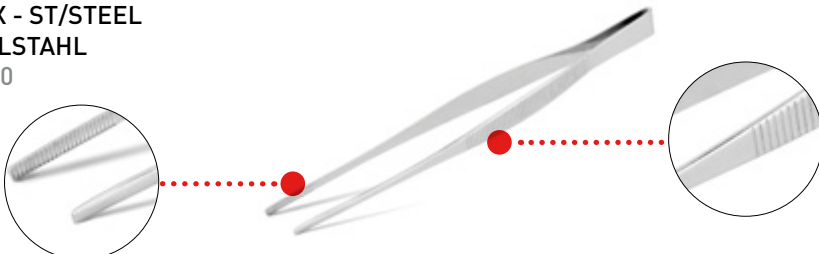

REF	L cm	U
P343.600	21	1

**P3437** Pinza Chef precisión pequeña / Small fine tip straight tweezer /  
Pince du chef précision petite / Kleine Präzisionspinzette

INOX - ST/STEEL  
EDELSTAHL  
18/10

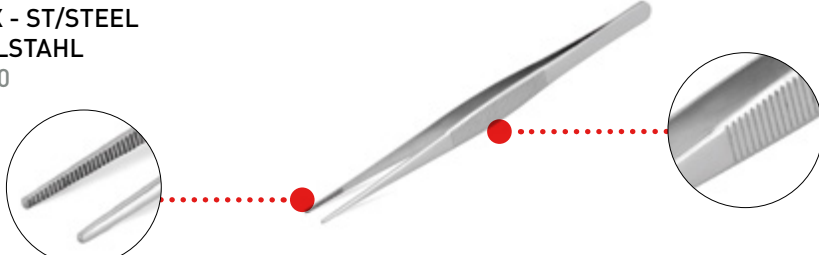

REF	L cm	U
P343.700	16	1

**P3438** Pinza sushi / Sushi tweezer /  
Pince à sushi / Sushipinzette

INOX - ST/STEEL  
EDELSTAHL  
18/10

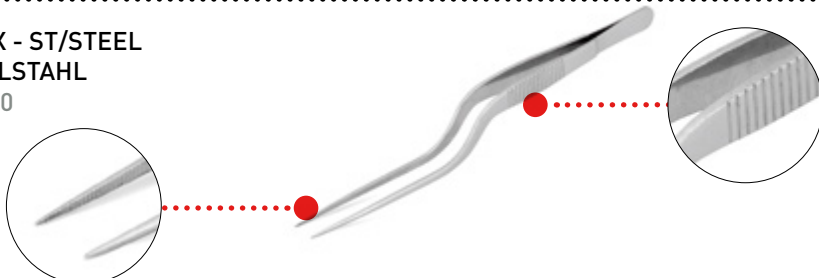

REF	L cm	U
P343.800	16	1

## P358 INOX Pinza buffet / Utility tong / Pince buffet / Buffetzange



REF	L cm	U
P358.024	24	12
P358.029	29,5	12
P358.040	40	12

## P358 COLOR Pinza buffet inox mango color / st. steel utility tong coloured handle / Pince buffet inox manche couleur / Rostfreie Buffetzange mit farbigem Griff



REF	L cm	BLANCO / WHITE / BLANC / WEISS	ROJO / RED / ROUGE / ROT	AZUL / BLUE / BLEU / BLAU	AMARILLO / YELLOW / JAUNE / GELB	VERDE / GREEN / VERT / GRÜN	MARRÓN / BROWN / MARRON / BRAUN	NEGRO / BLACK / NOIR / SCHWARZ	U
P358	24	1	2	3	4	5	6	7	1
P358	30	1	2	3	4	5	6	7	1
P358	40	1	2	3	4	5	6	7	1

Ref : P358 + L + Color / Colour / Couleur / Farbe

Fabricadas en acero inoxidable monobloc. Mango con revestimiento PVC aislante para una mejor sujeción / Made of one piece St/Steel. Handle with PVC coating for a better grip and insulation / Fabriquées en acier inoxydable monobloc. Manche avec revêtement PVC pour une meilleure préhension et isolation / Hergestellt aus rostfreiem Monoblock. Griff mit PVC Beschichtung für bessere Griffigkeit und Isolierung.



Forma /Shape /  
Forme / Form

FABRICADAS EN ACERO INOX, DE UNA SOLA PIEZA, EN FORMA DE W QUE ASEGURAN UNA MÁXIMA RESISTENCIA Y DURABILIDAD.

MADE OF A SINGLE PIECE OF STAINLESS STEEL, IN A W FORM TO ENSURE MAXIMUM RESISTANCE AND DURABILITY.

FABRIQUÉES EN ACIER INOX, EN UNE SEULE PIÈCE, EN FORME DE W, GARANTISSANT UNE RÉSISTANCE ET UNE DURABILITÉ MAXIMUMS.

AUS ROSTFREIEM STAHL, EINTEILIG, IN W-FORM, WAS MAXIMALE WIDERSTANDSKRAFT UND LANGLEBIGKEIT GARANTIERT.

## 4780620 Pinza buffet monobloc Kool-Touch® / One-Piece tong Kool-Touch® / Pince buffet inox Kool-Touch® / Rostfreie Buffetzange Kool-Touch®



REF	Color	L cm	U
4780620	Black	15	12
4780630	Blue	15	12
4780640	Red	15	12
4780650	Yellow	15	12
4780660	Orange	15	12
4780670	Green	15	12

Pinza más corta para espacios estrechos o comida delicada / Shorter utility tong for tight spaces or delicate food applications / Pince utilitaire courte pour espaces restreints ou aliments délicats à manipuler / Kürzere Universalzange für beengte Platzverhältnisse und das Arbeiten mit delikaten Speisen



Festoneada.  
Scalloped.  
Festonné.  
Gewellt.



Forma /Shape /  
Forme / Form

**4780920** Pinza buffet monobloc Kool-Touch® / One-Piece utility tong Kool-Touch® /  
Pince buffet Kool-Touch® / Einteilige, farblich gekennzeichnete Kool-Touch® gewellte Servierzangen



REF	Color	L cm	U
4780920	Black	24	12
4781220	Black	30	12
4781620	Black	40	12
4780930	Blue	24	12
4781230	Blue	30	12
4781630	Blue	40	12
4780940	Red	24	12
4781240	Red	30	12
4781640	Red	40	12
4780950	Yellow	24	12
4781250	Yellow	30	12
4781650	Yellow	40	12
4780960	Orange	24	12
4781260	Orange	30	12
4781660	Orange	40	12
4780970	Green	24	12
4781270	Green	30	12
4781670	Green	40	12



Festoneada.  
Scalloped.  
Festonné.  
Gewellt.

82 °C

Revestimiento mango / Coated handle /  
Revêtement queue / Griffbeschichtung



Forma / Shape /  
Forme / Form

**4790920** Pinza VERSAGRIP® Kool-Touch® / Once-Piece Kool-Touch® VERSAGRIP® tong /  
Pince monobloc VERSAGRIP® Kool-Touch® /  
Einteilige, farblich gekennzeichnete Kool-Touch® VERSAGRIP® Servierzangen



REF	Color	L cm	U
4790920	Black	24	12
4791220	Black	30	12
4791620	Black	40	12
4790930	Blue	24	12
4791230	Blue	30	12
4791630	Blue	40	12
4790940	Red	24	12
4791240	Red	30	12
4791640	Red	40	12
4790950	Yellow	24	12
4791250	Yellow	30	12
4791650	Yellow	40	12
4790960	Orange	24	12
4791260	Orange	30	12
4791660	Orange	40	12
4790970	Green	24	12
4791270	Green	30	12
4791670	Green	40	12



VERSAGRIP®  
Presenta extremos aplanados y dentados para mayor agarre. Perfecta para parrillas y asadores /  
Features flattened ends and gripper teeth.  
Perfect for grills and broilers /  
Offre des extrémités aplaties et crantées pour une meilleure prise. Parfaite pour grils et rôtissoires /  
Mit abgeflachten Enden und gezahntem Greifer.  
Perfekt zum Grillen und für Broiler

82 °C

Revestimiento mango / Coated handle /  
Revêtement queue / Griffbeschichtung



Forma / Shape /  
Forme / Form

**4780911** Pack pinzas multicolor / Multi-Pack Color-Coded Tong /  
Set pinces buffet à code couleur / Farblich gekennzeichnete Multipack-Universalzange

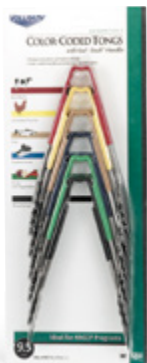

82 °C

Revestimiento mango / Coated handle /  
Revêtement queue / Griffbeschichtung

REF	L cm	U
4780911	24	3

Colores / Colours / Couleurs / Farben



Forma / Shape /  
Forme / Form



Festoneada.  
Scalloped.  
Festonné.  
Gewellt.

### 4780912 Pinza con extremo de nylon / Utility tong with nylon end / Pince utilitaire avec extrémité nylon / Universalzange mit Nylonenden



Festoneada.  
Scalloped.  
Festonné.  
Gewellt.

232 °C

REF	L cm	U
4780912	24	12
4781212	30	12
4781612	40	12



Forma / Shape /  
Forme / Form

Inox + Nylon / St/Steel + Nylon /  
Rostfreier Stahl + Nylon

### 4780922 Pinza con extremo de nylon y asa revestida / Utility tong with nylon end & coated handle / Pince utilitaire avec extrémité nylon et manche plastifié / Universalzange mit Nylonenden u. beschichtetem Griff

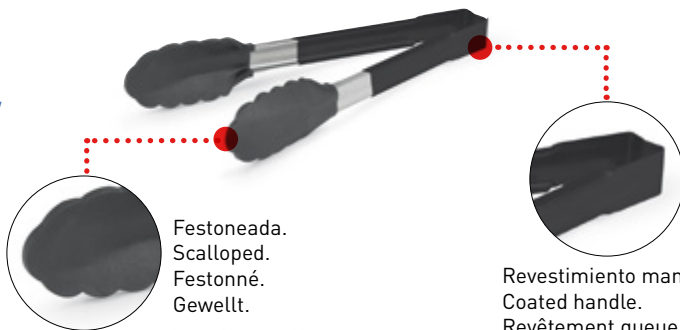

Festoneada.  
Scalloped.  
Festonné.  
Gewellt.

232 °C

Revestimiento mango.  
Coated handle.  
Revêtement queue.  
Griffbeschichtung.

82 °C

REF	L cm	U
4780922	24	12
4781222	30	12
4781622	40	12



Forma / Shape /  
Forme / Form

Inox + Nylon / St/Steel + Nylon /  
Rostfreier Stahl + Nylon

### 4780610 Pinza de acero inoxidable / Stainless steel tong / Pince inoxydable / Edelstahl-Servierzange

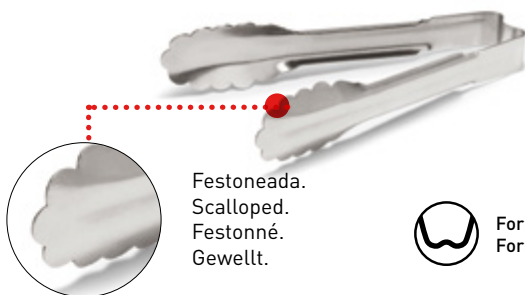

Festoneada.  
Scalloped.  
Festonné.  
Gewellt.



Forma / Shape /  
Forme / Form

REF	L cm	U
4780610*	15,2	12
4780910	24,1	12
4781210	30,5	12
4781610	40,6	12

\* Pinza mas corta para espacios estrechos o comida delicada /  
Shorter utility tong for tight spaces or delicate food applications /  
Pince utilitaire courte pour espaces restreints ou aliments delicats  
a manipuler /  
Kurzere Universalzange fur beengte Platzverhältnisse und das  
Arbeiten mit delikaten Speisen

### 4790910 Pinza VERSAGRIP® de acero inoxidable / VERSAGRIP® Stainless steel tong / Pince inox VERSAGRIP® / VERSAGRIP® Edelstahl-Servierzange

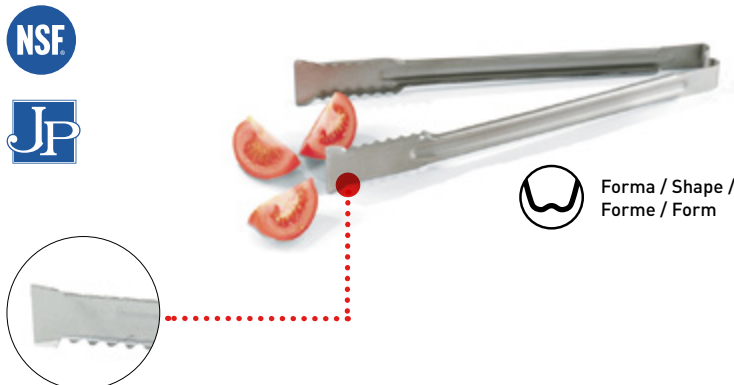

Forma / Shape /  
Forme / Form

REF	L cm	U
4790910	24,1	12
4791210	30,5	12
4791610	40,6	12

**IDEA!**

Ideal para barbacoa.  
Perfect for grills and broilers.  
Idéal pour barbecue.  
Ideal zum Grillen.

VERSAGRIP®  
presenta extremos aplanados y dentados para mayor agarre.  
Features flattened ends and gripper teeth.  
Offre des extrémités aplaties et crantées pour une  
meilleure prise.  
Mit abgeflachten Enden und gezahntem Greifer.



**47046** Pinza dentada reforzada /  
Reinforced Pom Tong /  
Pince ceinture renforcée /  
Verstärkte Gezahnte Zange



INOX - ST/STEEL  
EDELSTAHL

Construcción de una sola pieza / One-piece construction /  
Construction monobloc / Einteilige Ausführung

REF	L cm	U
47046	15,2	36
47049	22,9	24
47042	30,5	12

**47326** Pinza dentada reforzada Kool-Touch® /  
Kool-Touch® Reinforced Pom Tong /  
Pince ceinture renforcée Kool-Touch® /  
Kool-Touch® Verstärkte Gezahnte Zange



INOX - ST/STEEL  
EDELSTAHL

Construcción de una sola pieza / One-piece construction /  
Construction monobloc / Einteilige Ausführung

REF	L cm	U
47326	15,2	12
47329	22,9	12
47322	30,5	12

**P611** Pinza dentada / Pom tong /  
Pince ceinture / Gezahnte Zange



REF	L cm	U
P611.001	24	24

**47117** Pinza tipo tijeras de uso intensivo /  
Heavy-Duty scissor tongs /  
Pincas type ciseaux à usage intensif /  
Scherenzange für starke Beanspruchung



REF	Color	L cm	U
47325	■	38	12

**P620** Pala chips / chip bagger /  
Pelle à frites / Frittenschaufel



REF	cm	U
P620.001	23 x 21	1

Mano derecha / Right hand  
Main droite / Rechtshändig

**P621** Pala chips ABS / ABS chip bagger /  
Pelle à frites en ABS / Frittenschaufel ABS

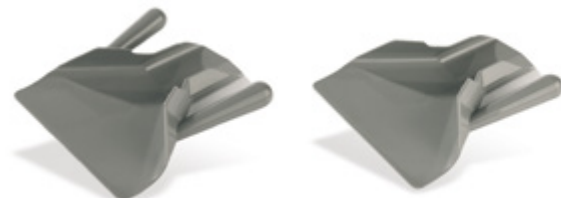

Ref. 621.000 (dual)

Ref. 621.001  
(mano derecha / right hand /  
Main droite / rechtshändig)

REF	cm	U
P621.000	23 x 21	1
P621.001	23 x 21	1

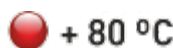

Espátula lisa, biselada /  
Solid, beveled turner with /  
Palette pleine, biseautée /  
Pfannenwender für schwere  
Beanspruchung Griffen massiv abgeschragt

**4808720**

232 °C

Ergo Grip®  
Mango / Handle /  
Queue / Griff

REF	Color	(L x W) cm	L cm	U
4808720		15 x 7,5	34,5	12
4808715		15 x 7,5	34,5	12

Espátula reforzada /  
Solid Turner /  
Palette renforcée /  
Edelstahl-Pfannenwender für schwere  
Beanspruchung massiv

**4808820**

232 °C

Ergo Grip®  
Mango / Handle /  
Queue / Griff

REF	Color	(L x W) cm	L cm	U
4808820		21 x 7,5	42	12
4808815		21 x 7,5	42	12

Espátula perforada reforzada /  
Perforated Turner with /  
Palette perforée renforcée /  
Edelstahl-Pfannenwender für  
schwere Beanspruchung perforiert

**4808920**

232 °C

Ergo Grip®  
Mango / Handle /  
Queue / Griff

REF	Color	(L x W) cm	L cm	U
4808920		21 x 7,5	42	12
4808915		21 x 7,5	42	12

Espátula nylon reforzada /  
Slotted reinforced nylon turner /  
Spatule renforcée à nylon /  
Hochtemperaturbeständiger  
Nylon-Pfannenwender,  
Geschlitzter Wender

**5284120**

245 °C

Nylon

REF	Color	L cm	U
5284120		34,5	12

Construcción de una sola pieza / One-piece construction /  
Construction monobloc / Einteilige Ausführung

MANGO ABS / ABS HANDLE / MANCHE EN ABS / ABS GRIFF

**P381** Espátula triangular "pintor" /  
Cleaning spatula /  
Palette triangle /  
Dreieckige Reinigungsspachtel



REF	cm	L cm	U
P381.008	8	24,5	12
P381.010	10	25	12

**P382** Pala bar /  
Spatula /  
Palette /  
Spachtel



REF	cm	L cm	U
P382.000	7 x 16	29	12

**P383** Pala fast-food y pescado /  
Fast-food and fish turner /  
Palette fast-food et poisson /  
Fast-Food und Fischschaufel

Flexible /  
Flexibel



REF	cm	L cm	U
P383.000	7,3 x 25	38	12

**P384** Pala fast-food perforada /  
perforated fast-food turner /  
Palette fast-food perforée /  
Fast-Food Schaufel gelocht

Flexible /  
Flexibel



REF	cm	L cm	U
P384.000	7,3 x 25	38	12

**P386** Rasqueta /  
Dough scraper /  
Raclette /  
Schaber



REF	cm	U
P386.000	15 x 7,5	12

**P380** Ruleta cortapizzas /  
Pizza wheel /  
Roulette à pizza /  
Pizzaschneider



REF	cm	L cm	U
P380.000	10	23,5	12

**P385** Espátula pastelera /  
Baker spatula /  
Palette /  
Kuchenspachtel



REF	PALA / PEEL / PELLE / BLATT cm	L cm	U
P385.020	20,5	34	12
P385.026	26	39	12
P385.030	30	43,5	12

**P3855** Espátula para untar /  
Butter spreader /  
Couteau à beurre /  
Aufstrichspachtel



REF	PALA / PEEL / PELLE / BLATT cm	L cm	U
P385.500	10,4 x 3,4	23	12

**P872** Pala pasteles /  
Cake server /  
Pelle à gâteau /  
Keksschaufel

Sin sierra /  
Without saw /  
Sans scie /  
Ohne säge



REF	L cm	U
P872.000	28	12

**P37501** Rasqueta triangular. Mango madera / Triangle dough scraper. Wood handle /  
Raclette triangle. Manche en bois / Dreieckiger Schaber. Holzgriff



REF	PALA / PEEL / PELLE / BLATT cm	L cm	U
P375.010	10,2 x 10	21	12

**P37502** Rasqueta semicírculo. Mango madera / Semicircle dough scraper. Wood handle /  
Raclette semicercle. Manche en bois / Halbrunder Schaber. Holzgriff



REF	PALA / PEEL / PELLE / BLATT cm	L cm	U
P375.020	10,2 x 10,5	24,2	12

**P37506** Pala bar. Mango madera / Spatula. Wood handle /  
Palette. Manche en bois / Schaufel. Holzgriff



REF	PALA / PEEL / PELLE / BLATT cm	L cm	U
P375.061	15,2 x 7,6	29	12
P375.062	17,8 x 7,6	31	12
P375.063	25,4 x 10,2	40,1	12

**P37504** Pala fast-food. Flexible. Mango madera / Fast-food turner. Flexible. Wood handle /  
Palette fast-food. Flexible. Manche en bois / Fast-Food Schaufel. Holzgriff



REF	PALA / PEEL / PELLE / BLATT cm	L cm	U
P375.041	25,4 x 7,6	37	12
P375.042	25,4 x 7,6	53	12

**P37505** Pala fast-food perforada. Flexible. Mango madera / Perforated fast-food turner. Flexible. Wood handle /  
palette fast-food perforée. Flexible. Manche en bois / Gelochte Fast-Food Schaufel. Holzgriff

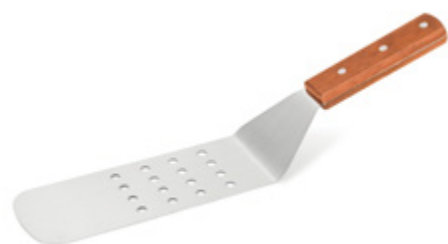

REF	PALA / PEEL / PELLE / BLATT cm	L cm	U
P375.050	25,4 x 7,6	37	12



**P37507** Rasqueta rectangular. Mango madera / Rectangular dough scraper. Wood handle /  
Raclette rectangle. Manche en bois / Rechteckiger Schaber. Holzgriff



REF	PALA / PEEL / PELLE / BLATT cm	L cm	U
P375.070	15,2 x 7,6	11,3	12

**P37508** Sierra. Mango madera / Saw. Wood handle /  
Sierra. Manche en bois / Säge. Holzgriff



REF	PALA / PEEL / PELLE / BLATT cm	L cm	U
P375.080	18,5 x 4,8	19 x 13	12

**P37509** Tenedor. Mango madera / Meat fork. Wood handle /  
Fourchette. Manche en bois / Fleischgabel. Holzgriff



REF	PALA / PEEL / PELLE / BLATT cm	L cm	U
P375.090	15,5 x 2,2 x 0,2	53,3	12

**P37510** Pala pasteles. Mango madera / Cake server. Wood handle /  
Pelle à gâteau. Manche en bois / Keksschaufel. Holzgriff



REF	PALA / PEEL / PELLE / BLATT cm	L cm	U
P375.100	15,2 x 5,1	26	12

**P37511** Espátula para untar. Mango madera / Butter spreader. Wood handle /  
Couteau à beurre. Manche en bois / Aufstrichspachtel. Holzgriff



REF	PALA / PEEL / PELLE / BLATT cm	L cm	U
P375.110	10,2 x 3,3	19,7	12

V I O L E T

C O L L E C T I O N

# ANTIALÉRGICO / ALLERGEN-FREE ANTI ALLERGIQUE / ANTI ALLERGIE

PREPARE Y SIRVA COMIDAS QUE NO CONTENGAN ALÉRGENOS /  
PREPARE AND SERVE ALLERGEN-FREE FOODS /  
PRÉPAREZ ET SERVEZ DES PLATS SANS ALLERGÈNE /  
MAHLZEITEN ZUBEREITEN UND SERVIEREN OHNE ALLERGENE



is your allergen free colour

ESPAÑOL

DETERMINE LOS UTENSILIOS PEQUEÑOS QUE VA A USAR PARA PREPARAR Y SERVIR COMIDAS QUE NO CONTENGAN ALÉRGENOS.  
COLOR MORADO PARA UNA RÁPIDA IDENTIFICACIÓN POR PARTE DE LOS EMPLEADOS Y CLIENTES

ENGLISH

DESIGNATE THOSE SMALLWARES WHICH ARE TO BE USED FOR PREPARING AND SERVING ALLERGEN FREE MEALS  
PURPLE COLOR FOR QUICK IDENTIFICATION BY EMPLOYEES AND CUSTOMERS

FRANÇAIS

DÉTERMINEZ LES PETITS USTENSILES QUE VOUS ALLEZ UTILISER POUR PRÉPARER ET SERVIR DES REPAS SANS ALLERGÈNES.  
COULEUR VIOLETTE POUR UNE RAPIDE IDENTIFICATION PAR LES EMPLOYÉS ET LES CLIENTS.

DEUTSCH

LEGEN SIE DIE KLEINEN UTENSILIEN FEST, DIE SIE VERWENDEN, UM ESSEN ZUZUBEREITEN UND ZU SERVIEREN, DAS KEINE  
ALLERGIESTOFFE ENTHÄLT. IN LILA FÜR EINE SCHNELLE IDENTIFIZIERUNG SEITENS MITARBEITER UND KUNDEN.

**55179** Kit antialérgico / Allergen-Free Kit /  
Kit anti allergique / Ständerset Anti Allergie

CONTIENE / CONTAINS /  
CONTIENT / ENTHÄLT

REF	U
55179	1



**1527-C80**

Caja de almacenamiento de comida /  
Food storage box /  
Boîte d'stockage /  
Lebensmittel Aufbewahrungsbox

REF	L cm
1527-C80	38,1 x 50,8 x 17,8



**1500-C80**

Tapa /  
Lid /  
Couvercle /  
Deckel

REF	L cm
1500-C80	39,7 x 57,2 x 6,4



**4780980**

Pinza monobloc Kool-Touch® /  
One-Piece utility tong Kool-Touch® /  
Pince buffet Kool-Touch® /  
Einteilige, farblich gekennzeichnete  
Kool-Touch® gewellter Servierzangen

REF	L cm
4780980	24



**6414080**

Cuchara servicio /  
Solid spoons /  
Cuillères à servir pleines /  
Massiv Löffel

REF	L cm
6414080	35



**4808880**

Espátula de acero inoxidable hoja lisa /  
Solid, stainless Steel Turner /  
Pelle pleine, inox /  
Edelstahl-Pfannenwender für schwere  
Beanspruchung

REF	cm	L cm
4808880	21 x 7,5	42,0



**4980280**

Cacillo monobloc Kool-Touch® /  
One-Piece ladle Kool-Touch® handle /  
Louche monobloc manche Kool-Touch® /  
Monoblock Schöpflöffel Kool-Touch® Griffen

REF	L cm	ml
4980280	25	60



**T401080**

Sarten antiadherente Wear-Ever® /  
Wear-Ever® non-stick fry pan /  
Poêle anti-adhésive Wear-Ever® /  
Antiharft Wear-Ever® Bratpfanne

REF	Ø cm	H cm
T401080	25	5,0



**47003**

Batidor con mango antiadherente /  
Whisk with anti-slip handle /  
Fouet avec poignée anti-crispation /  
Rührbesen Antirutschgriff

REF	L cm	MANGO / HANDLE / QUEUE / GRIFF L cm
47003	30,5	12

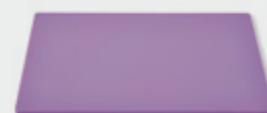

**5200080**

Tabla de corte /  
Cutting Board /  
Planche à découper /  
Schneidbretter

REF	L cm
5200080	30,5 x 45,7 x 1,3

**1527-C80**Caja de almacenamiento de comida /  
Food storage box /  
Boîte d'stockage /  
Lebensmittel Aufbewahrungsbox

NSF



REF	L cm	U
1527-C80	38,1 x 50,8 x 17,8	6

**1500-C80**Tapa /  
Lid /  
Couvercle /  
Deckel

NSF



REF	L cm	U
1500-C80	39,7 x 57,2 x 6,4	6
1522-C80*	40,3 x 54,9 x 2,5	6

\*Tapa ahuecada / Cover, recessed /  
Couvercle concave / Hohler Deckel**5200080**Tabla de corte /  
Cutting Board /  
Planche à découper /  
Schneidbretter

NSF



REF	L cm	U
5200080	30,5 x 45,7 x 1,3	6

**10815P**Manguito de repuesto / Replacement Handle /  
Manche de rechange / Ersatzgriffüberzüge

NSF



Cool Handle®

REF	TIPO / TYPE SARTENES / FRY PANS / POÊLES / BRATPFANNE (cm)	U
10815P*	18 & 20	36
10816P*	25 & 30	36

Sólo para sartenes Wear-Ever® / Just for Wear-Ever® /  
Seulement pour poêles Wear-Ever® / Nur für Wear-Ever®-Pfannen**T400780**Sarten antiadherente Wear-Ever® / Wear-Ever® non-stick fry pan /  
Poêle anti-adhésive Wear-Ever® / Antiharft Wear-Ever® Bratpfanne

SteelCoat 3

NSF



REF	Ø cm	H cm	U
T400780	18	4,0	6
T400880	20	5,0	6
T401080	25	5,0	6
T401280	30	5,5	2

**400780**

Sarten Wear-Ever® / Wear-Ever® fry pan / Poêle Wear-Ever® / Wear-Ever® Bratpfanne

NSF



REF	Ø cm	H cm	U
400780	18	4,0	6
400880	20	5,0	6
401080	25	5,0	6
401280	30	5,5	2



## 4761965

Bol Servicio doble pared cuadrado /  
Square Double-Wall Insulated Serving Bowl /  
Bol double pari /  
Quadratische, farbige, doppelwandig isolierte Servierschüsseln



REF	cm	Lts.	U
4761965	13.9 x 13.9 x 7	7	6
4763265	18.4 x 18.4 x 8.7	1,7	12
4763465	21.6 x 21.6 x 10.8	3,0	6
4763565	25.8 x 25.8 x 13	4,9	4
4763765	29.9 x 29.9 x 15	7,8	3

## 4658765

Bol Servicio doble pared redondo /  
Round Double-Wall Insulated Serving Bowl /  
Bol ronde double pari /  
Runde farbige, doppelwandig isolierte Servierschüsseln



REF	cm	Lts.	U
4658765	14,4 x 7,6	0,7	6
4659065	18,4 x 10,3	1,6	6
4659165	24,1 x 12,9	3,2	6
4659265	30 x 16,5	6,6	3
4656965	35 x 17,5	9,6	2

## 4780680

Pinza monobloc Kool-Touch® /  
One-Piece utility tong Kool-Touch® /  
Pince buffet Kool-Touch® /  
Einteilige, farblich gekennzeichnete  
Kool-Touch® gewellter Servierzangen



REF	L cm	U
4780680	15,0	12
4780980	24,0	12
4781280	30,5	12
4781680	40,5	12
478091280 *	24,0	12

## 6433480

Spoodle® monobloc redondo /  
One-Piece Round Spoodle® /  
Spoodle® monobloc ronde /  
Monoblok Rundschaalen Spoodle®



REF	L cm	ml	U
6433480	34,0	120	12
6433580	34,5	150	12

## 6432480

Spoodle® monobloc redondo perforado /  
One-Piece Round Perforated Spoodle® /  
Spoodle® monobloc ronde perforé /  
Monoblok Perforierten Rundschaalen Spoodle®



REF	L cm	ml	U
6432480	34	120	12

## 4980280

Cacillo monobloc Kool-Touch® /  
One-Piece leadle Kool-Touch® handle /  
Louche monobloc manche Kool-Touch® /  
Monoblock Schöpflöffel Kool-Touch® Griffen



REF	L cm	ml	U
4980280	25	60	12
4980480	32	120	12

**6414080** Cuchara servicio /  
Solid spoons /  
Cuillères à servir pleines /  
Massiv Löffel



232 °C



REF	L cm	U
6414080	35	12

**6414280** Cuchara servicio perforada /  
Perforated spoons /  
Cuillères à servir perforées /  
Perforiert Löffel



232 °C



REF	L cm	U
6414280	35	12

**4808780** Espátula de acero inoxidable hoja lisa /  
Solid, stainless steel Turner /  
Pelle pleine, inox /  
Edelstahl-Pfannenwender für schwere  
Beanspruchung



232 °C



REF	cm	L cm	U
4808780	15 x 7,5	34,5	12
4808880	21 x 7,5	42,0	12

**47147** Porcionador / Disher /  
Cuillère de service / Portionierer



REF	Ø cm	L cm	ml	U
47147	4	21	22	12

**47400** Porcionador / Disher /  
Cuillère de service / Portionierer



REF	TIPO/TYPE	L cm	ml	U
47400	Estándar	20,0	22	12
47378	Extendido	23,5	22	12

**47002** Batidor con mango antiadherente /  
Whisk with anti-slip handle /  
Fouet avec poignée anti-crispation /  
Rührbesen Antirutschgriff



246 °C



REF	L cm	L mango cm	U
47002	25,5	12	12
47003	30,5	12	12
47004	35,5	12	12
47005	40,5	12	12
47006	45,5	12	12





## GUÍA SELECCIÓN RALLADORES / GRATERS SELECTION GUIDE / GUIDE SÉLECTION RAPÊS / AUSWAHLÜBERSICHT REIBEN

	DOBLE NAVAJA / RIBON / TRANCHANTS / DOPPELKLINGEN	TIRAS LARGAS / LARGE SHAVER / LARGE COUPE / LANGE STREIFEN	FINO / FINE / FIN / FEIN	MEDIO / MEDIUM / MOYEN / MITTEL	GRUESO / EXTRA COARSE / GROS GRAINS / GROB	DUAL / DUAL / DOUBLE / DOPPEL
ZANAHORIA / CARROT / CAROTTE / KAROTTEN	✓	✓				✓
CEBOLLA / ONION / OIGNON / ZWIEBEL	✓			✓		✓
AJO / GARLIC / AIL / KNOBLAUCH			✓			
CHOCOLATE SCHOKOLADE	✓		✓	✓	✓	✓
CITRICOS / CITRUS / CITRON / ZITRONEN		✓	✓	✓		
PATATA / POTATO / POMME DE TERRE / KARTOFFEL	✓	✓				
MANZANA / APPLE / POMME / APFEL	✓	✓			✓	
QUESO DURO / HARD CHEESE / FROMAGE / HARTKÄSE	✓		✓	✓	✓	✓
QUESO BLANDO / SOFT CHEESE / FROMAGE / WEICHKÄSE	✓				✓	
NUEZ / NUT / NOIX / NÜSSE			✓	✓		✓
PIMIENTO / PEPPER / POIVRON / PFEFFER			✓	✓		✓
TOMATE / TOMATO / TOMATO / TOMATEN				✓	✓	

**P328** Rallador / Grater / Râpe / ReibeINOX - ST/STEEL  
ROSTFREIER STAHL

Ref. P328.600

REF	CARAS / SIDES / FACES / SEITEN	cm	H cm	U
P328.020	4	9 x 6,5	20,8	12
P328.023	4	10,5 x 8	23,3	12
P328.600	6	14,5 x 11	22,0	12

**P391** Rallador nuez moscada de acero inox / St/Steel nutmeg grater /  
Râpe à muscade en acier inox / Rostfreie Muskatnussreibe

REF	U
P391.000	12



**P3221** Rallador acero inoxidable "slim" con mango / St/Steel "slim" grater with handle /  
 Râpe inoxydable "slim" avec queue / Rostfreie Reibe "schmal" mit Griff

Ralladores de acero inoxidable. Mangos ergonómicos. Borde antideslizante  
 St/Steel graters. Ergonomic and soft touch handles. Non-slip rubber end  
 Râpes en acier inoxydable. Poignée ergonomique. Extrémité anti-dérapant  
 Rostfreie Reiben. Ergonomische Griffe. Antirutschrand.

REF	cm	U
P322.101	39,5 x 3,5	1
P322.102	39,5 x 3,5	1
P322.103	39,5 x 3,5	1
P322.104	39,5 x 3,5	1



ESPECIAL CÍTRICOS /  
 IDEAL FOR CITRUS /  
 IDÉAL POUR AGRUMES /  
 IDEAL FÜR ZITRUSFRÜCHTE



REF. P322.104  
 Fino  
 Fine  
 Fin  
 Fein



REF. P322.101  
 Dual  
 Dual  
 Double  
 Doppel



REF. P322.103  
 Medio  
 Medium  
 Moyen  
 Medium



REF. P322.102  
 Doble navaja  
 Ribon  
 Tranchants  
 Zwei Klingen

**P3222** Rallador acero inoxidable "wide" con mango / St/Steel "wide" grater with handle /  
 Râpe inoxydable "wide" avec queue / Rostfreie Reibe "breit" mit Griff

Ralladores de acero inoxidable. Mangos ergonómicos. Borde antideslizante  
 St/Steel graters. Ergonomic and soft touch handles. Non-slip rubber end  
 Râpes en acier inoxydable. Poignée ergonomique. Extrémité anti-dérapant  
 Rostfreie Reiben. Ergonomische Griffe. Antirutschrand.

REF	cm	U
P322.201	31,5 x 7,3	1
P322.202	31,5 x 7,3	1
P322.203	31,5 x 7,3	1
P322.204	31,5 x 7,3	1



ESPECIAL CÍTRICOS /  
 IDEAL FOR CITRUS /  
 IDÉAL POUR AGRUMES /  
 IDEAL FÜR ZITRUSFRÜCHTE



REF. P322.204  
 Fino  
 Fine  
 Fin  
 Fein



REF. P322.201  
 Tiras largas  
 Large shaver  
 Large coupe  
 Lange Streifen



REF. P322.202  
 Doble navaja  
 Ribon  
 Tranchants  
 Zwei Klingen



REF. P322.203  
 Grueso  
 Extra coarse  
 Gros grains  
 Grob

**P374** Colador doble malla en acero inoxidable / St/Steel double mesh strainer /  
Passoire double maille en acier inox / Doppelmaschiges Sieb rostfrei

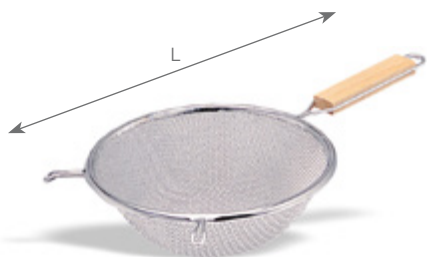

REF	Ø cm	L cm	LUZ DE MALLA / MESH SIZE / MALLAGE / MASCHENWEITE mm	U
P374.013	13	30	1-3	72
P374.015	15	32	1-3	72
P374.018	18	34	1-3	72
P374.020	20	38	1-3	72
P374.026	26	58,5	1,6-3	72

**P375** Colador doble malla en acero inoxidable. Reforzado / St/Steel double mesh strainer. Reinforced /  
Passoire double maille en acier inox. Renforcé / Doppelmaschiges Sieb rostfrei und verstärkt



REF	Ø cm	L cm	LUZ DE MALLA / MESH SIZE / MALLAGE / MASCHENWEITE mm	U
P375.030	30	79	1,040	1
P375.035	35	86,5	1,040	1

**P324** Colador 1/2 bola reforzado en acero inox / St/Steel reinforced 1/2 ball colander /  
Passoire ronde renforcé en acier inox / Halbkugeliges Sieb rostfrei und verstärkt

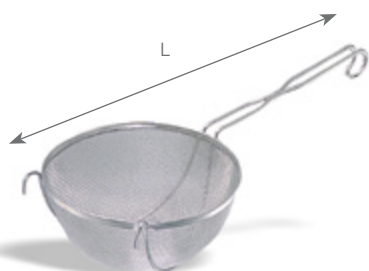

REF	Ø cm	L cm	LUZ DE MALLA / MESH SIZE / MALLAGE / MASCHENWEITE mm	U
P324.013	13	36	0,530	12
P324.016	16	40	0,530	12
P324.019	19	42,5	0,530	12
P324.022	22	49	0,530	12
P324.025	25	55,5	0,530	12

**P348** Colador cónico en acero inoxidable / St/Steel conical strainer /  
Passoire conique en acier inox / Konisches Sieb rostfrei und verstärkt

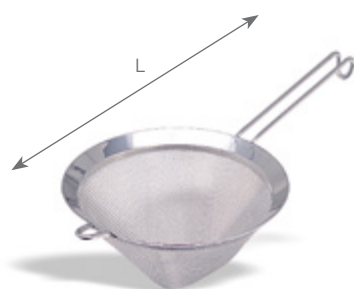

REF	Ø cm	L cm	LUZ DE MALLA / MESH SIZE / MALLAGE / MASCHENWEITE mm	U
P348.008	8	22,5	0,700	96
P348.010	10	24,5	0,700	96
P348.012	12	31,5	0,700	96
P348.015	15	35	0,700	96
P348.018	18	40,5	0,700	72

**P325** Colador media bola en acero inox / St/Steel hemispherical strainer /  
Passoire demi-sphérique en acier inox / Halbrundes Sieb rostfrei

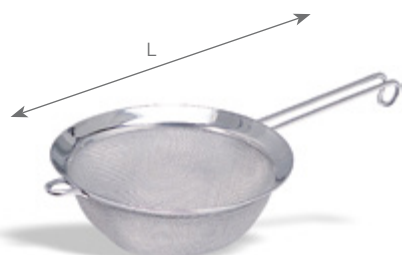

REF	Ø cm	L cm	LUZ DE MALLA / MESH SIZE / MALLAGE / MASCHENWEITE mm	U
P325.008	8	22,5	0,700	96
P325.010	10	25,2	0,700	96
P325.012	12	32,5	0,700	96
P325.015	15	40,2	0,700	72
P325.018	18	42,5	0,700	72
P325.020	20	44,5	0,700	72

**P303** Colador chino / Conical colander / Chinois / Spitzsieb



REF	Ø cm	H cm	U
P303.016	16,8	34,8	12
P303.018	18,6	38,4	12
P303.020	21,1	39,7	12
P303.022	23,2	44,0	12
P303.024	25,1	46,0	12
P303.026	27,2	47,8	12

**P347** Colador chino con malla / Conical colander with wire gauze / Chinois à gaze / Spitzsieb mit Maschen



REF	Ø cm	LUZ DE MALLA / MESH SIZE / MAILLAGE / MASCHENWEITE mm	U
P347.020	20	0,700	12
P347.024	24	0,700	12

**P970** Soporte para chino o embudo / Stand for chinese colander or funnel / Support pour chinois ou entonnoir / Ständer für Spitzsieb und Trichter



REF	Ø cm	H cm	U
P970.000	16	19	1

**P3032** Triángulo / Triangle / Triangle / Dreieck

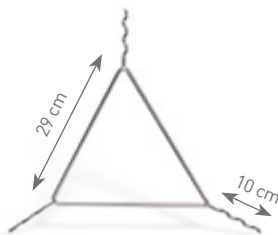

REF	L cm	U
P303.200	29	1

Triángulo equilátero  
Equilateral triangle  
Triangle équilatéral  
Gleichseitiges Dreieck

**P373** Colador bayeta / Cotton strainer / Passe-bouillon / Textilsieb



REF	Ø cm	U
P373.020	20	6
P373.024	24	6
P373.028	28	6

Acero inoxidable y algodón  
St/Steel and cotton  
Acier inoxydable et cotton  
Rostfrei und Baumwolle

### P308

Escurridera / Conical colander /  
Passoire conique / Konischer Seiher

INOX - ST/STEEL  
EDELSTAHL  
18/10

Extra fuerte /  
Heavy duty /  
Grande résistance /  
Extra stark



REF	Ø cm	H cm	U
P308.030	30	16,0	1
P308.035	35	16,5	1
P308.040	40	18,0	1
P308.045	45	19,5	1
P308.050	50	22,5	1

### P109

Escurridera con aro / Conical colander /  
Passoire conique / Konischer Seiher mit Ring

ALUMINIO /  
ALUMINIUM



REF	Ø cm	H cm	U
P109.030	30	14,5	1
P109.035	35	16,5	1
P109.040	40	17,5	1
P109.045	45	20,0	1
P109.050	50	22,5	1

### P300

Escurridera inox con base / st/steel colander with stand /  
Passoire inox sur pied / Seiher rostfrei mit Ständer

INOX - ST/STEEL  
ROSTFREIER STAHL



REF	Ø cm	H cm	U
P300.024	24	11,50	1
P300.030	30	13,50	1

### P321

Colador / Colander /  
Passoire / Seiher

INOX - ST/STEEL  
EDELSTAHL  
18/10



REF	Ø cm	U
P321.020	20	1
P321.022	22	1
P321.024	24	1
P321.026	26	1

### P945

Harinero / Flour bin /  
Tamis à farine / Mehlsieb



REF	cm	U
P945.037	37 x 26,5 x 18	1
P945.050	50 x 26,5 x 18	1
P945.051	50 x 33 x 18	1



**P313** Pasapurés / Vegetable sieve /  
Moulin à légumes / Passiermaschine



REF	Ø cm	Ø FILTRO / FILTER / FILTRE / FILTER cm	U
P313.025	25	11,5	1
P313.030	30	14,5	1



Con 2 discos inox. intercambiables /  
With 2 St/Steel interchangeable cutters /  
Avec 2 coupoirs inox interchangeables /  
Mit 2 auswechselbaren Scheiben rostfrei

**P3131** Pasapurés / Vegetable sieve /  
Moulin à légumes / Passiermaschine



REF	Ø cm	Ø FILTRO / FILTER / FILTRE / FILTER cm	U
P313.126	26	10,5	1
P313.132	32	16,5	1



Con 2 discos inox. intercambiables /  
With 2 St/Steel interchangeable cutters /  
Avec 2 coupoirs inox interchangeables /  
Mit 2 auswechselbaren Scheiben rostfrei

**P3132** Pasapurés plástico /  
Plastic vegetable sieve /  
Mouline à légumes en plastique /  
Passiermaschine Plastik

Con 3 discos inox. intercambiables /  
With 3 St/Steel interchangeable cutters /  
Avec 3 coupoirs inox interchangeables /  
Mit 3 auswechselbaren Scheiben rostfrei



REF	Ø cm	Ø FILTRO / FILTER / FILTRE / FILTER cm	U
P313.200	23,5	13,5	1

**P3135** Pasapurés / Potato ricer /  
Presse-purés / Kartoffelpresse



REF	Ø cm	L cm	U
P313.500	9	30,5	1

**P958** Gancho acero inoxidable 1p. / St/Steel hook 1p. / Crochet inox 1p. / Haken rostfrei 1 St.



REF	L mm	U
P958.010	100 x 4	1
P958.012	120 x 5	1
P958.014	140 x 6	1
P958.016	160 x 6	1
P958.018	180 x 6	1

\*Precio caja 10 unidades  
\*Price 10 units box  
\*Prix colis 10 unités  
\*Preis Kiste 10 Teile

**P868** Dispensador a presión / Squeeze dispenser / Distributeur à pression / Einzeldosierer

REF	COLOR / COLOUR / COULEUR / FARBE	ml	H cm	Ø cm	U
P868.001	●	240	18,0	5	12
P868.002	●	360	21,0	5	12
P868.003	●	720	24,5	5	12
P868.004	●	240	18,0	5	12
P868.005	●	360	21,0	5	12
P868.006	●	720	24,5	5	12
P868.007*	○	240	18,0	5	12
P868.008*	○	360	21,0	5	12
P868.009*	○	720	24,5	5	12

\* Transparente / Clear / Transparent

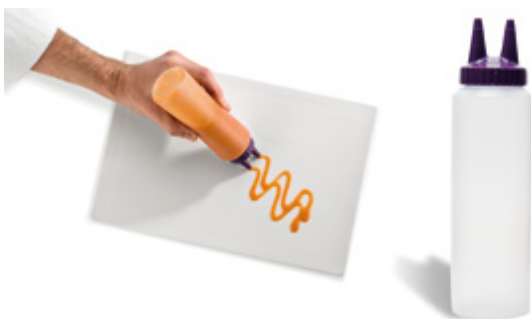
**2208-1354** Dispensador a presión doble / Twin squeeze dispenser / Distributeur à pression double / Zweifachdosierer

REF	COLOR / COLOUR / COULEUR / FARBE	ml	H cm	Ø cm	U
2208-1354	○	200	18,0	5	12

Transparente / Clear / Transparen

**IDEA!**

Ideal para decoración  
Ideal for dish presentation  
Idéal pour decoration  
Ideal für die Dekoration

**3316-13191** Dispensador a presión triple / Tri squeeze dispenser / Distributeur à pression triple / Dreifachdosierer

REF	COLOR / COLOUR / COULEUR / FARBE	ml	H cm	Ø cm	U
3316-13191	○	500	18,0	5	12

Transparente / Clear / Transparent

**IDEA!**

Ideal para decoración  
Ideal for dish presentation  
Idéal pour decoration  
Ideal für die Dekoration

**2908** Dispensador a presión con tapón cierre rosca / Squeeze dispenser with open-close system cap / Distributeur pressurisation a/capuchon d'ouverture-fermeture / Druckdosierer mit Schraubdeckel

Ref. 2908-13

Ref. 5324-13

REF	ml	H cm	Ø cm	U
2908-13	240	18,4	5,1	1
2912-13	350	18,4	6,0	1
5324-13	710	24,4	7,3	1

Transparente / Clear / Transparent



**26120** Dispensador a presión con tapón / Squeeze dispenser with cap /  
Distributeur pression avec capuchon / Druckdosierer mit Deckel



Ref. 26120-13

Ref. 26240-13

Ref. 26320-13

REF	ml	H cm	Ø cm	U
26120-13	350	16,2	6,2	1
26240-13	710	22,5	7,5	1
26320-13	950	22,9	8,6	1

Transparente / Clear / Transparent



**4961** Especieros / Dredgers / Saupoudreuses / Streuer



Ref. 4961-13191

Ref. 4961-1332

Ref. 4961-1308

Ref. 4961-1301

REF	ml	Ø cm	Ø cm	H cm	U
		AGUJEROS / HOLES / TROUS / LÖCHER			
4961-13191	470	0,14	7,3	16	1
4961-1332	470	0,25	7,3	16	1
4961-1308	470	0,46	7,3	16	1
4961-1301	470	0,94	7,3	16	1

Transparente / Clear /  
Transparent

**P946** Especieros / Dredgers / Saupoudreuses / Streuer

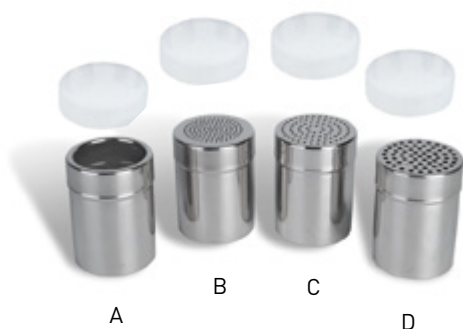

A

B

C

D

REF	Ø cm	H cm	Ø mm	U
A P946.001	7	9,6	-	12
B P946.002	7	9,6	2	12
C P946.003	7	9,6	3	12
D P946.004	7	9,6	4	12

Especiero "A" con malla  
Dredger "A" with mesh  
Saupoudreuse "A" maillée  
Streuer "A" mit Maschen

Con tapón de plástico  
With plastic cover  
Avec couvercle en plastique  
Mit Plastideckel

**P954** Embudo con filtro extraíble / Funnel with removable filter /  
Entonnoir avec filtre extractible / Trichter mit herausnehmbarem Filter



REF	Ø1 cm	Ø2 cm	U
P954.013	13	2,6	1
P954.015	15	2,6	1
P954.020	20	3,2	1
P954.025	25	3,2	1

Molde huevo sandwich redondo /  
Round egg ring /  
Moule à oeuf rond /  
Runde Sandwicheierform

**P870**

REF	Ø cm	H cm	U
P870.000	8,5	11,0	1

Molde huevo sandwich cuadrado /  
Squared egg mould /  
Moule à oeuf carré /  
Rechteckige Spiegeleierform

**P871**

REF	cm	H cm	U
P871.000	8,5 x 8,5	11,0	1

Aplastacarnes inox forjado /  
Solid St/Steel meat beater /  
Aplatisseur inox forgé /  
Solider Fleischstampfer rostfrei

**P905**

REF	Ø cm	Kg	L cm	U
P905.015	10	1,5	14	1

Aplastadora carne /  
Meat tenderizer /  
Aplatisseur à viande /  
Fleischstampfer

**P942 / P943**

REF	Ø cm	Kg	L cm	U
P942.000	9,5	0,750	28,5	1
P943.000	9,5	0,750	28,5	1

**P334** Alcuza / Oil pourer /  
Huilière / Ölkanne



REF	Lts	U
P334.025	0,25	1
P334.050	0,50	1
P334.100	1,00	1
P334.200	2,00	1

**P873** Barra de notas de aluminio /  
Aluminium check minder /  
Barre porte-bons en aluminium /  
Aluminiumleiste für Notizen



REF	L cm	H cm	U
P873.045	45	5,0	1
P873.060	60	5,0	1
P873.090	90	5,0	1



**P941** Sierra de cocina / kitchen bow saw /  
Scie de cuisine / Küchensäge



REF	cm	U
P941.000	62 x 20	1
RE 941.001	Hoja / Blade / Lame / Blatt	6

**P94009** Remo acero inoxidable /  
St/Steel mixing paddle /  
Spatule géante inoxydable /  
Rührpaddel rostfrei



REF	PALA / PEEL / PELLE / BLATT CM	L cm	U
P940.090	12 x 19	90	1
P940.120	16 x 19,5	120	1

**P323** Tenedor / fork / Fourchette / Spiess



REF	L cm	U
P323.050	50	5

**P940** Rascador con mango aluminio /  
Grill scraper aluminium /  
Raclette à plancha /  
Schaber mit Aluminiumgriff



REF	cm	U
P940.000	44,5 x 12 x 12,7	1
RE 940.001	12,7 x 7,7	1

**P944** Escamador / Fish scaler /  
Ecailleur / Fischentschupper



REF	L cm	U
P944.000	23,5	1

**P953** Cepillo multiusos / Utility brush /  
Brosse de nettoyage / Nützliche Bürste



REF	cm	U
P953.000	23,5 x 7,5	1

# REDCO® PUJADAS®



## AMPLIA GAMA DE PROCESADORES DE ALIMENTOS MANUALES

---

CORTA VERDURAS Y FRUTAS  
HASTA 11 VECES MÁS RÁPIDO QUE EL CORTE A MANO  
FÁCIL INTERCAMBIO DE LAS CUCHILLAS  
LIMPIEZA RÁPIDA Y FÁCIL

## WIDE RANGE OF MANUAL FOOD PROCESSORS

---

CUTS BOTH FRUIT AND VEGETABLES  
SPEED UP YOUR WORK 11 TIMES FASTER THAN HAND CUTTING  
EASY-TO-REMOVE INTERCHANGEABLE BLADES  
EASY TO CLEAN

## LARGE GAMME D'APPAREILS MANUELS DE TRANSFORMATION DES ALIMENTS

---

COUPE LES LÉGUMES ET LES FRUITS  
JUSQU'À 11 FOIS PLUS RAPIDE QUE LORSQUE VOUS COUPEZ À LA MAIN  
COUTEAUX FACILEMENT INTERCHANGEABLES  
NETTOYAGE RAPIDE ET FACILE

## GROSSE AUSWAHL AN HANDLICHEN SCHNEIDEMASCHINEN

---

GEEIGNET FÜR OBST UND GEMÜSE  
11MAL SCHNELLER ALS HANDSCHNEIDEN  
MÜHELOSE AUSTAUSCHBARKEIT DER KLINGEN  
SCHNELLE UND EINFACHE REINIGUNG



DADOS Y BASTONCILLOS /  
DICE & STICKS /  
CUBES ET BÂTONNETS /  
WÜRFEL UND STÄBCHEN



REBANADA / SLICE /  
TRANCHES / SCHEIB



GAJOS / WEDGE /  
QUARTIERS / ZERTEILER

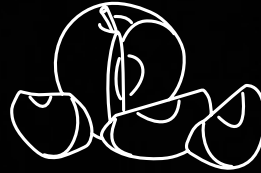

SACACORAZONES / CORE /  
ÉVIDOIR / ENTKERNER



## PROCESADORES MANUALES DE ALIMENTOS / MANUAL FOOD PROCESSORS / APPAREILS MANUELS DE TRANSFORMATION DES ALIMENTS / MANUELLE KÜCHENMASCHINEN



\*VELOCIDADES / SPEEDS /  
VITESSES / GESCHWINDIGKEITEN

	3x	3x	3x
 Limones / Lemons Citrons / Zitronen			
 Limas / Limes Citrons verts / Limonen			
 Naranjas / Oranges Oranges / Orangen			
 Tomates / Tomatoes Tomates / Tomaten	✓	✓	
 Cebollas / Onions Oignons / Zwiebeln	✓	✓	
 Apio / Celery Céleri / Stangensellerie	✓	✓	
 Pimientos / Peppers Poivrons / Paprikaschoten	✓	✓	
 Patatas / Potatoes Pommes de terre / Kartoffeln	✓	✓	
 Manzanas / Apples Pommes / Äpfel	✓ 4x	✓ 4x	
 Peras / Pears Poires / Birnen	✓ 4x	✓ 4x	
 Lechuga / Lettuce Laitue / Kopfsalat			
 Pimientos / Bell peppers Poivrons / Paprikaschoten	✓		
 Pepino / Cucumbers Concombres / Gurken			✓

\*Veces más rápido que cortar a mano.  
Faster than cutting by hand.  
Fois plus rapide qu'une coupe à la main.  
Schneller als das Schneiden von Hand.



**Reduzca el tiempo de mano de obra /**  
 Reduce labor time /  
 Réduisez le temps de travail /  
 Reduzieren Sie Ihre Arbeitszeit



5x	11x	2,5x	3x	3x	5x
		✓	✓	✓	
		✓	✓	✓	
		✓	✓	✓	
			✓	✓	✓
✓		✓			
		✓	✓	✓	
			✓	✓	
			✓	✓	
✓	✓				
✓					
✓					



**55000**

Cortador-Rebanador de sobremesa grande / Big size tabletop dicer & slicer /  
Grand Coupe légumes en tranches et cubes / Größer Tisch Würfelschneider und -hobel für Arbeitsflächen



**InstaCut™ 5.0**

Sobremesa /  
Tabletop /  
A poser /  
Arbeitsflächen

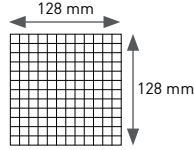

ADAPTABLE A / ADJUSTABLE TO /  
ADAPTABLE À / GEEIGNET FÜR

DENTRO / INSIDE /  
DANS / INNERHALB (MAX)  
1/3 100 mm  
1/4 150 mm  
1/6 150 mm

FUERA / OUTSIDE /  
EXTÉRIEUR / AUßERHALB (MAX)  
1/1 200 mm

Con ventosas de agarre en la base.  
With suction base.  
Avec ventouse d'accrochement à la base.  
Mit Saugfüßen.



REF	TIPO/TYPE	CORTE / CUT COUPE / SCHNITT mm	U
55000		6,4	1
55001		9,5	1
55002		12,7	1

REBANADA / SLICE / TRANCHES / SCHEIB			
55011		6,4	1

REF	TIPO/TYPE	SECCIONES / SECTION / QUARTIERS / STÜCK	U
GAJOS / WEDGE / QUARTIERS / ZERTEILER			
15153		10	1
15155		12	1

\*H 50,8 cm ABIERTO / OPEN / OUVERT / OFFEN  
\*H 47 cm CERRADO / CLOSED / FERMÉ / GESCHLOSSEN



ASA EN T, BLOQUE DE EMPUJE Y CUCHILLA /  
T-HANDLE, PUSHER BLOCK AND BLADE /  
POIGNÉE EN T, BLOC DE POUSSÉE ET LAME /  
T-GRIFF, DRUCKBLOCK UND MESSER

SOLO CUCHILLA DE REEMPLAZO /  
REPLACEMENT BLADE ONLY /  
LAME DE RECHANGE SEULE /  
NUR ERSATZMESSER

TIPO/TYPE	mm	REF
DADOS - BASTONCILLOS / DICE & STICKS / CUBES ET BÂTONNETS / WÜRFEL UND STÄBCHEN		

	6,4	55059
	9,5	55060
	12,7	55061

REBANADA / SLICE / TRANCHES / SCHEIB		
	6,4	55088

SECCIONES / SECTION / QUARTIERS / STÜCK		
GAJOS / WEDGE / QUARTIERS / ZERTEILER		

	6	1515106
	8	1515208
	10	1515310
	12	1515512

SACACORAZONES / CORE / ÉVIDOIR / ENTKERNER		
	6	1512606
	8	1512808

REF
55062
55063
55064

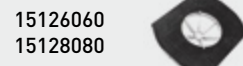
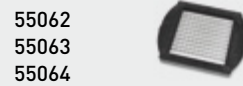



**15000** Cortador-Rebanador de sobremesa pequeño / Small size tabletop dicer & slicer /  
Coupe légumes en tranches et cubes de table / Kleiner Tisch Würfelschneider und - hobel für Arbeitsflächen



**InstaCut™ 3.5**

Sobremesa /  
Tabletop /  
À poser /  
Arbeitsflächen

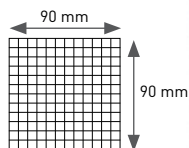

ADAPTABLE A / ADJUSTABLE TO /  
ADAPTABLE À / GEEIGNET FÜR

DENTRO / INSIDE / DANS / INNERHALB (MAX)

- 1/3 40 mm
- 1/4 65 mm
- 1/6 65 mm

FUERA / OUTSIDE /  
EXTÉRIEUR / AUßERHALB (MAX)

- 1/1 200 mm

Con ventosas de agarre en la base.  
With suction base.  
Avec ventouse d'accrochement à la base.  
Mit Saugfüßen.



**3x**



Más rápido / Faster

**4x**



Más rápido / Faster

REF	TIPO/TYPE	CORTE / CUT COUPE / SCHNITT mm	U
-----	-----------	--------------------------------------	---

DADOS - BASTONCILLOS / DICE & STICKS / CUBES ET BÂTONNETS / WÜRFEL UND STÄBCHEN

15000		6,4	1
15001		9,5	1
15002		12,7	1

REF	TIPO/TYPE	SECCIONES / SECTION / QUARTIERS / STÜCK	U
-----	-----------	--	---

GAJOS / WEDGE / QUARTIERS / ZERTEILER

15003		4	1
15005		6	1
15006		8	1
15007		10	1
15008		12	1

REF	TIPO/TYPE	SECCIONES / SECTION / QUARTIERS / STÜCK	U
-----	-----------	--	---

SACACORAZONES / CORE / ÉVIDOIR / ENTKERNER

15010		8	1
-------	--	---	---

\*H 45,7 cm ABIERTO / OPEN / OUVERT / OFFEN  
\*H 43,5 cm CERRADO / CLOSED / FERMÉ / GESCHLOSSEN

**15016** Cortador-Rebanador de pared / Wall mount dicer & slicer /  
Coupe légumes fixation murale / Tischwürfelschneider und - hobel zur Wandmontage



**InstaCut™ 3.5**

Pared /  
Wall mount /  
Fixation murale /  
Wandmontage



REF	TIPO/TYPE	CORTE / CUT COUPE / SCHNITT mm	U
-----	-----------	--------------------------------------	---

DADOS - BASTONCILLOS / DICE & STICKS / CUBES ET BÂTONNETS / WÜRFEL UND STÄBCHEN

15016		6,4	1
15017		9,5	1

REF	TIPO/TYPE	SECCIONES / SECTION / QUARTIERS / STÜCK	U
-----	-----------	--	---

GAJOS / WEDGE / QUARTIERS / ZERTEILER

15019		4	1
15022		8	1
15024		12	1

\*H 56,5 cm ABIERTO / OPEN / OUVERT / OFFEN  
\*H 35,6 cm CERRADO / CLOSED / FERMÉ / GESCHLOSSEN

ASA EN T, BLOQUE DE EMPUJE Y CUCHILLA / T-HANDLE, PUSHER BLOCK AND BLADE /  
POIGNÉE EN T, BLOC DE POUSÉE ET LAME / T-GRIFF, DRUCKBLOCK UND MESSER

Ref. 15000 - 15010

Ref. 15016-15024

TIPO/TYPE mm REF

DADOS - BASTONCILLOS / DICE & STICKS / CUBES ET BÂTONNETS / WÜRFEL UND STÄBCHEN

	6,4	15059
	9,5	15060
	12,7	15061
	6,4 x 12,7	15085

SECCIONES / SECTION /  
QUARTIERS / STÜCK

GAJOS / WEDGE / QUARTIERS / ZERTEILER

	4	15050
	6	15052
	8	15053
	10	15054
	12	15055

SACACORAZONES / CORE / ÉVIDOIR / ENTKERNER

	8	15058
--	---	-------

SOLO CUCHILLA DE REEMPLAZO /  
REPLACEMENT BLADE ONLY /  
LAME DE RECHANGE SEULE /  
NUR ERSATZMESSER

REF

15062	
15063	
15064	
15086	

15065	
15067	
15068	
15069	
15070	

15072	
-------	--



**55010** Cortadora de pepinos / Cucumber slicer / Coupe-concombre / Gurkenscheider

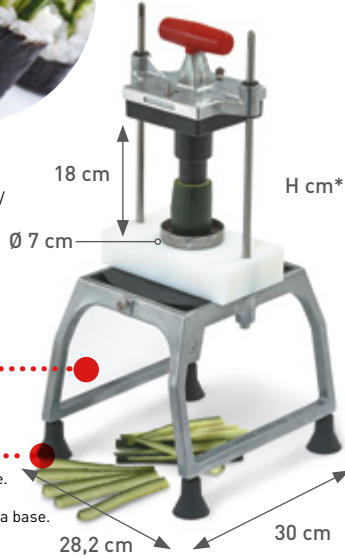

ADAPTABLE A / ADJUSTABLE TO / ADAPTABLE À / GEEIGNET FÜR

DENTRO / INSIDE / DANS / INNERHALB (MAX)  
1/3 100 mm  
1/4 150 mm  
1/6 150 mm

FUERA / OUTSIDE / EXTÉRIEUR / AUßERHALB (MAX)  
1/1 200 mm

Con ventosas de agarre en la base.  
With suction base.  
Avec ventouse d'accrochement à la base.  
Mit Saugfüßen.

REF	TIPO/TYPE	SECCIONES / SECTION / QUARTIERS / STÜCK	Ø cm	U
SACACORAZONES / CORE / ÉVIDOIR / ENTKERNER				
55010		14	2,5	1

\*H 61 cm ABIERTO / OPEN / OUVERT / OFFEN  
\*H 57,4 cm CERRADO / CLOSED / FERMÉ / GESCHLOSSEN

SOLO CUCHILLA DE REEMPLAZO / REPLACEMENT BLADE ONLY / LAME DE RECHANGE SEULE / NUR ERSATZMESSER

REF	TIPO/TYPE	SECCIONES / SECTION / QUARTIERS / STÜCK	Ø cm	U
SACACORAZONES / CORE / ÉVIDOIR / ENTKERNER				
55025		10	2,2	1
55028		14	2,5	1

Rebana pepinos a lo largo y los descaraza al mismo tiempo.  
Slices cucumbers lengthwise and cores at the same time.  
Coupe les concombres dans le sens de la longueur et les évide en même temps.  
Schneidet Gurken der Länge nach bei gleichzeitiger Entkernung.

**IDEA!** Ideal para barras de ensaladas y sushi.  
Great for salad bars and sushi.  
Parfait pour les bars à salades et sushi.  
Hervorragend geeignet für Salatbars und Sushi.

**3x** Más rápido / Faster

**47713** Cortador de patatas / Potato cutter / Coupe-pommes de terre / Pommes-Frites-Scheider

Scan me



Click me

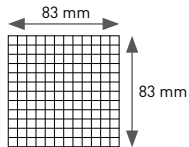
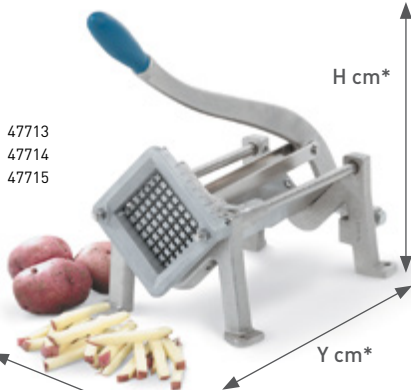

REF	TIPO/TYPE	CORTE / CUT COUPE / SCHNITT mm	U
DADOS - BASTONCILLOS / DICE & STICKS / CUBES ET BÂTONNETS / WÜRFEL UND STÄBCHEN			
47713		7	1
47714		10	1
47715		11	1
GAJOS / WEDGE / QUARTIERS / ZERTEILER			
47703**		8	1

SOPORTE PARED / WALL HANGER BRACKET / SUPPORT DE SUSPENSION MURALE / WANDAUFHÄNGUNG  
45682^^ 1

\*Y 87,6 cm H 58,4 cm ABIERTO / OPEN / OUVERT / OFFEN  
\*Y 45,0 cm H 35,6 cm CERRADO / CLOSED / FERMÉ / GESCHLOSSEN

SOLO CUCHILLA DE REEMPLAZO / REPLACEMENT BLADE ONLY / LAME DE RECHANGE SEULE / NUR ERSATZMESSER

REF	TIPO/TYPE	CORTE / CUT COUPE / SCHNITT mm	U
DADOS - BASTONCILLOS / DICE & STICKS / CUBES ET BÂTONNETS / WÜRFEL UND STÄBCHEN			
45751-1		7	1
45749-1		10	1
45750-1		11	1

Agujeros para tornillos en la base de las patas para el montaje permanente en mesas o paredes.  
Screw holes on base of legs for permanent mounting to table or wall.  
Trous à vis sur la base des pieds pour fixation permanente sur une table ou un mur.  
Schraubenlöcher im Boden der Standfüße zur dauerhaften Befestigung an Tisch oder Wand.

\*\*Se ofrecen cuchillas y piezas adicionales.  
Extra blades and parts available.  
Lames et pièces supplémentaires disponibles.  
Zusätzliche Messer und Teile erhältlich.



45682  
^^No se incluyen los tornillos.  
Screws not included.  
Vis non fournies.  
Schrauben nicht inbegriffen.

30 x 21,5 cm

### 400N Cortador de lechuga / Salad cutter / Coupe-Salade / Salatschneider



Scan me



ADAPTABLE A /  
ADJUSTABLE TO /  
ADAPTABLE À /  
GEEIGNET FÜR (MAX)  
1/1 100 mm  
1/2 150 mm

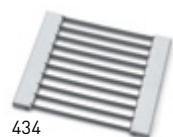

434  
17 x 15 cm

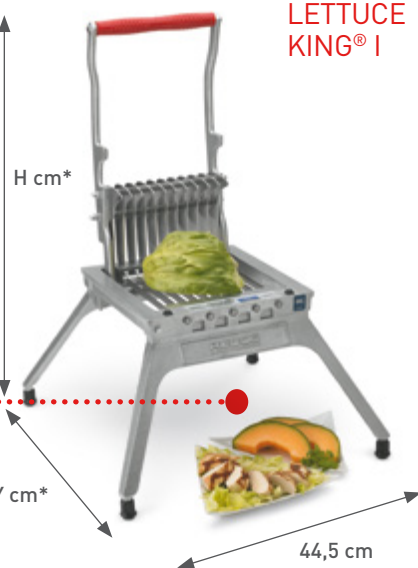

LETTUCE  
KING® I

REF	TIPO/TYPE	CORTE / CUT COUPE / SCHNITT mm	CUCHILLAS / BLADES / LAMES / MESSER	U
400N		4,8	37	1
403N		6,4	28	1
402NC		9,5	19	1
401N		19,0	10	1

\*Y 48,3 cm H 45,7 cm ABIERTO / OPEN / OUVERT / OFFEN  
\*Y 59,1 cm H 43,5 cm CERRADO / CLOSED / FERMÉ / GESCHLOSSEN

CONJUNTO DE CUCHILLAS / BLADE ASSEMBLY /  
JEU DE LAMES / MESSEREINHEIT

REF	TIPO/TYPE	CORTE / CUT COUPE / SCHNITT mm	CUCHILLAS / BLADES / LAMES / MESSER	U
435		4,8	37	1
485		6,4	28	1
484C		9,5	19	1
434		19,0	10	1

Corte un cuarto de cabeza de lechuga a la vez.  
Cut a quarter head of lettuce at a time.  
Coupez un quart de tête de laitue à la fois.  
Schneidet jeweils ein Salatkopfviertel.



5x  
Más rápido / Faster

### 4400N Cortador de lechuga / Salad cutter / Coupe-Salade / Salatschneider

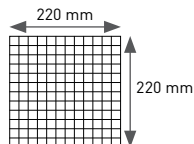

ADAPTABLE A /  
ADJUSTABLE TO /  
ADAPTABLE À / G  
EIGNET FÜR (MAX)  
1/1 200 mm  
1/2 200 mm

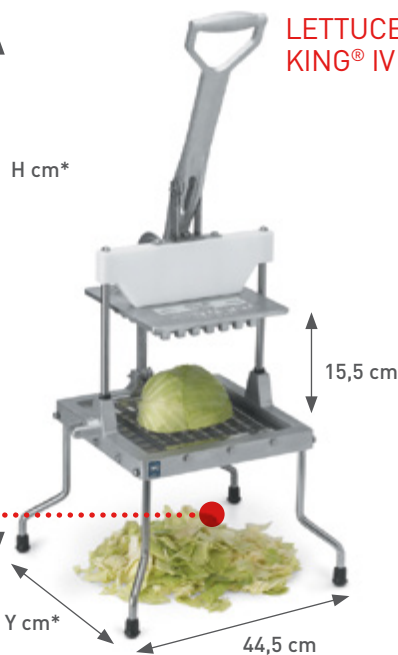

LETTUCE  
KING® IV

REF	TIPO/TYPE	CORTE / CUT COUPE / SCHNITT mm	U
4400N		25,4 x 25,4	1

\*Y 43,2 cm H 81,3 cm ABIERTO / OPEN / OUVERT / OFFEN  
\*Y 47 cm H 54,9 cm CERRADO / CLOSED / FERMÉ / GESCHLOSSEN

CONJUNTO DE CUCHILLAS / BLADE ASSEMBLY /  
JEU DE LAMES / MESSEREINHEIT

REF	CORTE / CUT COUPE / SCHNITT mm	U	
4408		25,4 x 25,4	1

No oscurece la lechuga.  
Does not bruise the lettuce.  
N'abime pas la laitue.  
Vermeidet Verletzungen der empfindlichen Salatblätter

11x  
Más rápido / Faster

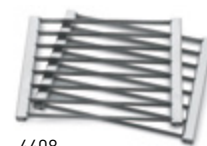

4408



UTENSILIOS DE COCINA / KITCHEN UTENSILS / USTENSILES DE CUISINE / KÜCHENUTENSILIEN

**403NH** Rebanadora de frutas y verduras / Fruit & vegetable slicer / Coup-fruit et légumes / Obstschneider

Scan me



Click me

ADAPTABLE A /  
ADJUSTABLE TO /  
ADAPTABLE À /  
GEEIGNET FÜR (MAX)  
1/2 65 mm

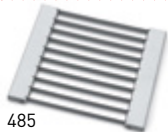

485  
17 x 15 cm



H cm\*

Y cm\*

33 cm

REF	TIPO/TYPE	CORTE / CUT COUPE / SCHNITT mm	CUCHILLAS / BLADES / LAMES / MESSER	U
403NH		6,4	28	1

\*Y 33,6 cm H 50,8 cm ABIERTO / OPEN / OUVERT / OFFEN  
\*Y 55,7 cm H 23,3 cm CERRADO / CLOSED / FERMÉ / GESCHLOSSEN

SOLO CUCHILLA DE REEMPLAZO / REPLACEMENT BLADE ONLY /  
LAME DE RECHANGE SEULE / NUR ERSATZMESSER

REF	TIPO/TYPE	CORTE / CUT COUPE / SCHNITT mm	CUCHILLAS / BLADES / LAMES / MESSER	U
485		6,4	28	1

Área de corte completa de 12,7 cm para frutas grandes.  
Full 12.7 cm cutting area optimal for large fruits.  
Longueur de coupe de 13 cm optimale pour les fruits volumineux.  
Großer 12,5-cm-Schneidbereich eignet sich optimal für große Obstsorten.

No oscurece la fruta durante el corte, reduciendo así los desechos.  
Prevents bruising of fruit during cutting, reducing food waste.  
N'abime pas le fruit durant la coupe, réduisant le gaspillage.  
Verhindert Quetschverletzungen am Obst beim Schneiden und reduziert die Verschwendung.

**500N** Cortador de cebollas / Onion cutter / Coupe-onions / Zwiebelschneider



ONION KING®

ADAPTABLE A / ADJUSTABLE TO /  
ADAPTABLE À / GEEIGNET FÜR  
(MAX)  
1/1 65 mm  
1/2 65 mm  
1/3 100 mm  
1/4 100 mm  
1/6 100 mm



P510  
13 x 6 cm

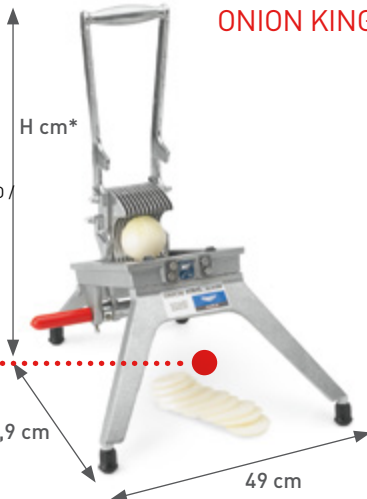

H cm\*

34,9 cm

49 cm

REF	TIPO/TYPE	CORTE / CUT COUPE / SCHNITT mm	CUCHILLAS / BLADES / LAMES / MESSER	U
500N		4,8	13	1
501N		6,4	11	1
502N		9,5	7	1
503N		12,7	6	1

\*H 49 cm ABIERTO / OPEN / OUVERT / OFFEN  
\*H 39,4 cm CERRADO / CLOSED / FERMÉ / GESCHLOSSEN

CONJUNTO DE CUCHILLAS / BLADE ASSEMBLY /  
JEU DE LAMES / MESSEREINHEIT

REF	TIPO/TYPE	CORTE / CUT COUPE / SCHNITT mm	CUCHILLAS / BLADES / LAMES / MESSER	U
509		4,8	13	1
511		6,4	11	1
510		9,5	7	1
512		12,7	6	1

Espesor de rebanada exacto.  
Exact slice thickness.  
Épaisseur de tranches exacte.  
Exakte Scheibendicke.

**2,5x** **Más rápido / Faster**

**15604** Cortador cebollas en flor / Bloom onion cutter / Coupe onion en fleur / Zwiebelschneider in Blumenform



Scan me



Click me

INSTABLOOM® II



H cm\*

36,2 cm

35,6 cm

REF	TIPO/TYPE	SECCIONES / SECTION / QUARTIERS / STÜCK	U
15604		24	1

\*H 76,2 cm ABIERTO / OPEN / OUVERT / OFFEN  
\*H 48,3 cm CERRADO / CLOSED / FERMÉ / GESCHLOSSEN

CONJUNTO DE CUCHILLAS / BLADE ASSEMBLY /  
JEU DE LAMES / MESSEREINHEIT

REF	TIPO/TYPE	SECCIONES / SECTION / QUARTIERS / STÜCK	U
15601		24	1

Fabricación de aluminio moldeado altamente resistente.  
Constructed from heavy duty cast aluminum.  
En aluminium coulé ultra-robuste.  
Aus stark belastbarem Aluminiumguss.

Tiene cuchillas de acero inoxidable con bordes de precisión.  
Features precision edged stainless steel blades.  
Lames inox de précision.  
Mit präzisionsgefertigten Edelmessern.

Con ventosas de agarre en la base.  
With suction cup base.  
Avec ventouse d'accrochement à la base.  
Mit Saugfüßen.



15601



## 606N Cortador seccionador de tomates y cítricos / Tomato and lemon wedger / Diviseur à tomates et agrumes / Wedger Schneider



Scan me



Click me



308

ADAPTABLE A / ADJUSTABLE TO /  
ADAPTABLE À / GEEIGNET FÜR  
DENTRO / INSIDE / DANS / INNERHALB (MAX)

1/3 40 mm  
1/4 40 mm  
1/6 40 mm

FUERA / OUTSIDE /  
EXTÉRIEUR / AUßERHALB (MAX)

1/1 200 mm  
1/2 200 mm

\*Con protección de seguridad.  
With safety guard.  
Avec sécurité.  
Mit Schutzblende.

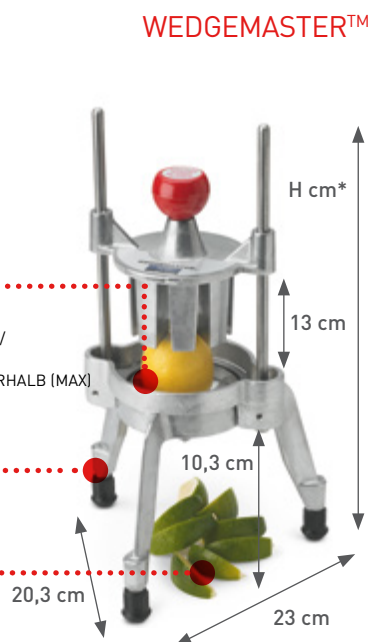

WEDGEMASTER™

REF	SECCIONES / SECTION / QUARTIERS / STÜCK	SE VENDE CON CUCHILLAS / SHIPS WITH BLADES / DESCRIPTION DE LA COUPE / MESSER IM LIEFERUMFANG ENTHALTEN	U
606N	6	P306/P336	1
808N	8	P308/P338	1
808SG*	8	P308/P338	1

CONJUNTO DE CUCHILLAS / BLADE ASSEMBLY /  
JEU DE LAMES / MESSEREINHEIT

REF	TIPO/TYPE	SECCIONES / SECTION / QUARTIERS / STÜCK	U
GAJOS / WEDGE / QUARTIERS / ZERTEILER			
306		6	1
308		8	1
SACACORAZONES / CORE / ÉVIDOIR / ENTKERNER			
336		6	1
338		8	1

\*H 40,6 cm ABIERTO / OPEN / OUVERT / OFFEN

\*H 40,3 cm CERRADO / CLOSED / FERMÉ / GESCHLOSSEN



Más rápido / Faster

## 700-1 Cortador seccionador de tomates y cítricos / Tomato and lemon wedger / Diviseur à tomates et agrumes / Wedger Schneider



Scan me



Click me



708 Ø 9 cm

FUERA / OUTSIDE /  
EXTÉRIEUR / AUßERHALB (MAX)

1/1 200 mm

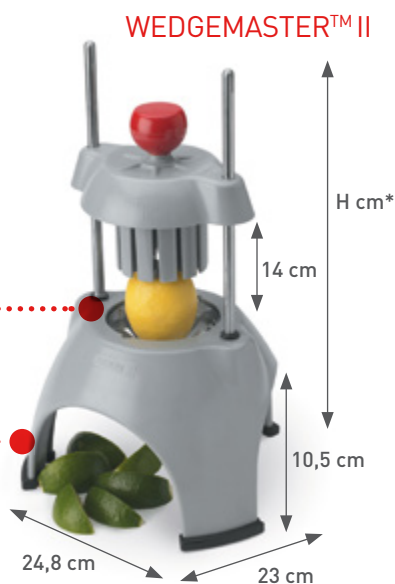

WEDGEMASTER™ II

REF	SECCIONES / SECTION / QUARTIERS / STÜCK	U
700-1	6	1
700-4	8	1

CONJUNTO DE CUCHILLAS / BLADE ASSEMBLY /  
JEU DE LAMES / MESSEREINHEIT

REF	TIPO/TYPE	SECCIONES / SECTION / QUARTIERS / STÜCK	U
GAJOS / WEDGE / QUARTIERS / ZERTEILER			
704		4	1
706		6	1
708		8	1
712		12	1

Fabricación de material de policarbonato para lavavajillas.  
Constructed of dishwasher safe polycarbonate material.  
En polycarbonate qui passe au lave-vaisselle.  
Aus spülmaschinenfestem Polycarbonatmaterial hergestellt.

\*H 40,6 cm ABIERTO / OPEN / OUVERT / OFFEN

\*H 38,7 cm CERRADO / CLOSED / FERMÉ / GESCHLOSSEN



Más rápido / Faster





**P937** Máquina multi-usos / Versatil machine / Machine universel / Universelle Maschine

Cortador patatas  
French fry cutter  
Coupe frites  
Kartoffelschneider



Ø 8,5 cm



□ 12 x 12 mm



Cortador manzanas  
Apple cutter & corer  
Vide et coupe pommes  
Apfelschneider



REF	H cm	U
P937.000	80	1

REF	U
RE937.001 Recambio cortador patatas / French fry cutter spare part / Coupe frites (pièce rechange) / Austauschbarer Pommesschneider	1
RE937.002 Recambio cortador manzanas / Apple cutter spare part / Coupe pommes (pièce rechange) / Austauschbarer Apfelschneider	1
RE937.003 Recambio exprimidor zumos / Juicer spare part / Press fruits (pièce rechange) / Austauschbarer Entsafter	1

Exprimidor zumos  
Juicer  
Presse-fruits  
Entsafter

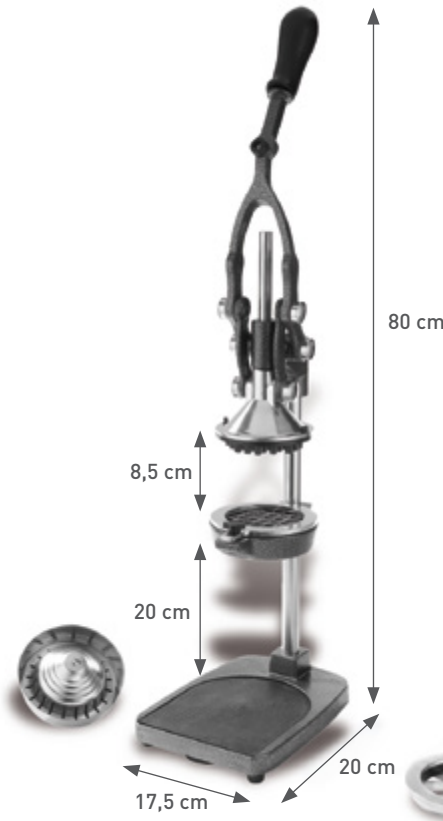

**47704** Exprimidor de zumos / Juice extractor / Extracteur de jus / Saftpresse



REF	U
47704	1

Mejor acción de palanca para sacar la máxima cantidad de jugo.  
Superior leverage for maximum juice output.  
Effet de levier supérieur pour presser un maximum de jus.  
Hervorragende Hebelwirkung garantiert maximale Entsaftung.

Base de hierro fundido esmaltado altamente resistente.  
Heavy-duty enamel-coated cast iron base.  
Base en fonte émaillée ultra-solide.  
Für starke Beanspruchung ausgelegter, emaillierter Gusseisensockel.

Las patas de goma evitan los deslizamientos durante el uso.  
Rubber feet assure no-slide use.  
Pieds en caoutchouc antidérapants.  
GummifüÙe verhindern ein jegliches Verrutschen.



UTENSILIOS DE COCINA / KITCHEN UTENSILS / USTENSILES DE CUISINE / KÜCHENUTENSILIEN

**P9759** Cortador de tomates / Tomatoes slicer / Coupe tomates / Tomatenschneider



REF	CORTE / CUT COUPE / SCHNITT mm	cm	U
P975.900	6,4	39 x 21,5 x 20	1
RE975.901	6,4	25 x 6,8	1

**5x** **Más rápido / Faster**  
 RE975.901 Cuchilla / Blade / Lame / Klingen



**0643N** Cortador de tomates / Tomatoes slicer / Coupe tomates / Tomatenschneider

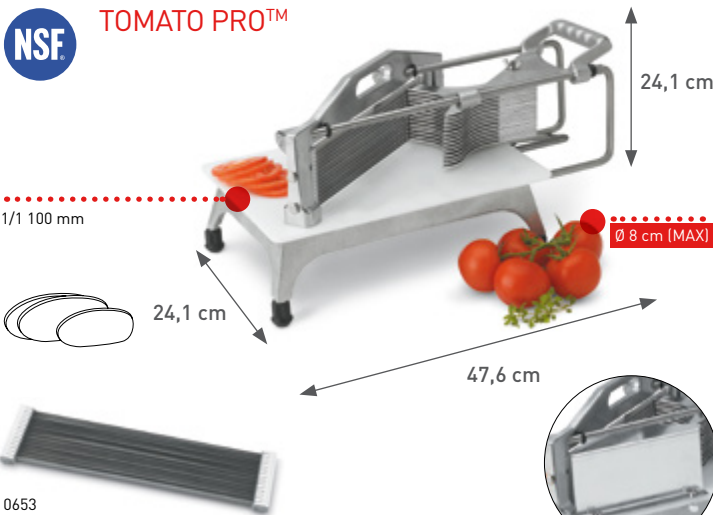

REF	CORTE / CUT COUPE / SCHNITT mm	CUCHILLAS / BLADES / LAMES / MESSER	U
0643N*	4,8	15	1
0644N**	6,4	11	1
0643SGN**	4,8	15	1
0644SGN***	6,4	11	1

CUCHILLA DE REEMPLAZO / REPLACEMENT BLADE ITEM / LAME DE RECHARGE / ERSATZMESSER			
REF	CORTE / CUT COUPE / SCHNITT mm	CUCHILLAS / BLADES / LAMES / MESSER	U
*0653	4,8	15	1
**0654	6,4	11	1

\*Con protección de seguridad. Permite sujeción a la mesa.  
 With safety guard. Holds firmly on countertop.  
 Avec sécurité. Fixation ferme sur la table.  
 Mit Schutzblende. Hält fest auf dem Tisch.

**5x** **Más rápido / Faster**

**15105** Cortador de tomates / Tomatoes slicer / Coupe tomates / Tomatenschneider

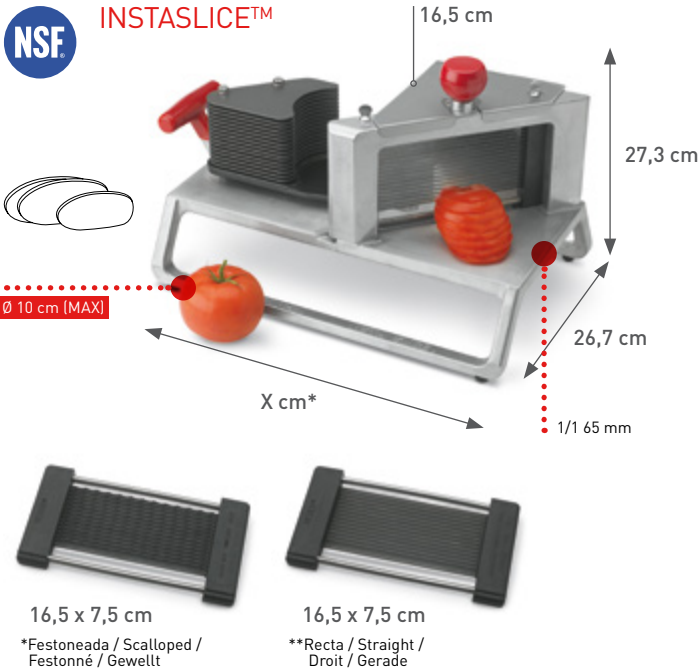

REF	TIPO / TYPE	CORTE / CUT COUPE / SCHNITT mm	CUCHILLAS / BLADES / LAMES / MESSER	U
15105*		4,8	16	1
15205**		4,8	16	1
15103*		6,4	12	1
15104*		9,5	8	1

\*X 44,5 cm ABIERTO / OPEN / OUVERT / OFFEN  
 \*X 40,6 cm CERRADO / CLOSED / FERMÉ / GESCHLOSSEN

CUCHILLA DE REEMPLAZO / REPLACEMENT BLADE ITEM / LAME DE RECHARGE / ERSATZMESSER				
REF	TIPO / TYPE	CORTE / CUT COUPE / SCHNITT mm	CUCHILLAS / BLADES / LAMES / MESSER	U
15115*		4,8	16	1
15209**		4,8	16	1
15113*		6,4	12	1
15114*		9,5	8	1

Conjuntos de cuchillas encajables para facilitar el reemplazo.  
 "Pop-in pop out" blade assemblies for easy replacement.  
 Lames qui s'installent et se sortent par détente pour un remplacement facile.  
 Messer lassen sich zum einfachen Auswechseln leicht einsetzen und herausnehmen.

**5x** **Más rápido / Faster**  
 Resistente a la corrosión.  
 Corrosion resistant.  
 Résistant à la corrosion.  
 Korrosionsbeständig.



**1811** Cortador en cubos / Cube cutter / Coupe en cubes / Würfelschneider

CUBEKING™

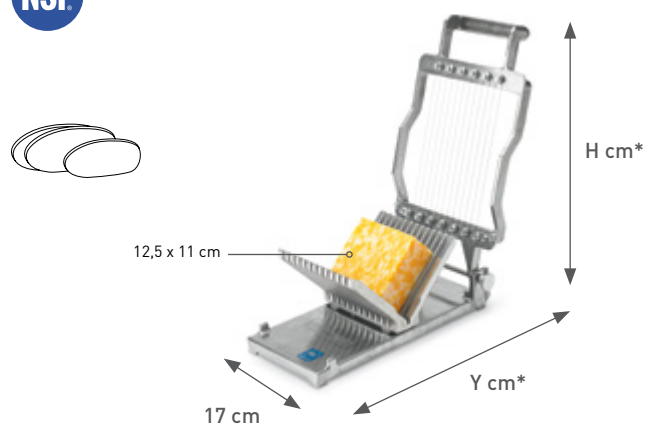

REF	CORTE / CUT COUPE / SCHNITT mm	U
1811	19,1	1
1812	9,5	1

\*Y 33 cm \*H 34 cm ABIERTO / OPEN / OUVERT / OFFEN  
\*Y 32 cm \*H 11 cm CERRADO / CLOSED / FERMÉ / GESCHLOSSEN

JUEGO DE ALAMBRES DE REPUESTO / REPLACEMENT WIRE KIT /  
KIT DE FIL DE RECHANGE / DRAHT-ERSATZKIT

REF	U
1823	1

Produce cubos, palillos y bloques cuadrados o rectangulares de queso.  
Produce uniform cheese cubes, sticks, and square or rectangular blocks.  
Produisez des dés, bâtonnets et blocs carrés ou rectangulaires de fromage.  
Erzeugen Sie einheitlich große Käsewürfel, Stäbchen und quadratische oder rechteckige Blöcke.

**1837** Cortador quesos / Cheese cutter / Coupe fromage / Käse Drahtschneider

CHEESE BLOCKER™

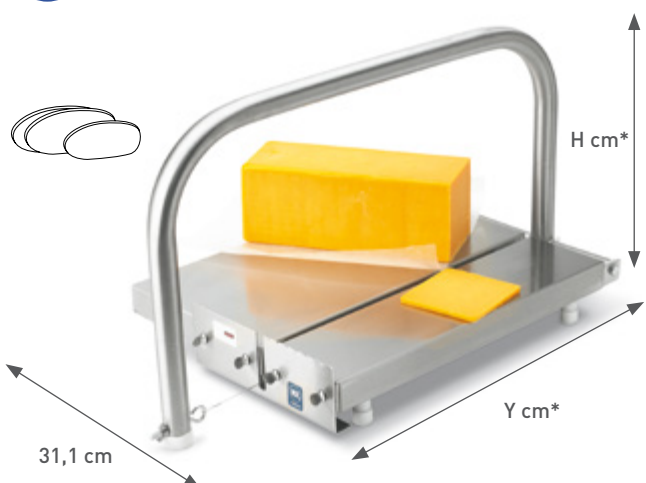

REF	U
1837	1

\*Y 74,3 cm H 57,5 cm ABIERTO / OPEN / OUVERT / OFFEN  
\*Y 55,8 cm H 31,1 cm CERRADO / CLOSED / FERMÉ / GESCHLOSSEN

JUEGO DE ALAMBRES DE REPUESTO / REPLACEMENT WIRE KIT /  
KIT DE FIL DE RECHANGE / DRAHT-ERSATZKIT

REF	U
1838	1

Admite quesos en bloques de hasta 20 kg y circulares de hasta 15 kg.  
Accommodates cheese blocks up to 20 kg and wheels up to 15 kg.  
Compatible avec les blocs de fromage de 20 kg max. et les meules de 15 kg max.  
Für Käseblöcke von bis zu 20 kg und Rader von bis zu 15 kg.

Incrementos de medición de 1,3 cm en la placa frontal y la base.  
1,3 cm measuring increments on front plate and base.  
Incréments de mesure de 1,3 cm sur la plaque avant et la base.  
1,3-cm-Skalenstufen auf Frontplatte und Boden.

**1853** Abridor de ostras / Oyster opener / Ouvre huîtres / Austeröffner

OYSTER KING™



REF	U
1853	1

\*Y 26,7 cm H 38,1 cm ABIERTO / OPEN / OUVERT / OFFEN  
\*Y 37,5 cm H 10,8 cm CERRADO / CLOSED / FERMÉ / GESCHLOSSEN

CUCHILLA DE REEMPLAZO / REPLACEMENT BLADE ITEM / LAME DE RECHARGE / ERSATZMESSER

REF	U
5382	1



**6003** Procesador versátil manual / Versatile manual processor /  
 Processeur versatile et manuel / Multifunktionsreibe

**KING KUTTER™**



REF	INCLUYE / INCLUDES / COMPREND / UMFASST	U
6003	1, 2, 4	1
6005	1, 2, 3, 4, 5	1

\*X 21 cm    ABIERTO / OPEN / OUVERT / OFFEN  
 \*X 12,7 cm    CERRADO / CLOSED / FERME / GESCHLOSSEN



**P9640** Abrelatas industrial acero inoxidable / St/Steel can opener /  
 Ouvre-boîtes professionnel en acier inoxydable / Industrieller Edelstahl Dosenöffner



REF	H cm	U
P964.001	60	1

CUCHILLA DE RECAMBIO / KNIFE (SPARE PART) /  
 COUPEAU (PIÈCE DE RECHANGE) / AUSTAUSCHKLINGE

REF	U
RE964.100	1

RODILLO DE RECAMBIO / WHEEL (SPARE PART) /  
 ROULEAU (PIÈCE DE RECHANGE) / AUSTAUCHRAD

REF	U
RE964.200	1

55 cm  
 Altura máxima de las latas.  
 Maximum height of cans.  
 Hauteur maximale des boîtes.  
 Maxmale Höhe der Dosen.



**P975** Cortador de patatas fritas / French fry cutter / Coupe frites / Pommesschneider

Acero inox  
Stainless steel  
Acier inoxydable  
Rostfreier Stahl

ADAPTABLE A / ADJUSTABLE TO /  
ADAPTABLE À / GEEIGNET FÜR

FUERA / OUTSIDE /  
EXTÉRIEUR / AUßERHALB (MAX)  
1/1 65 mm

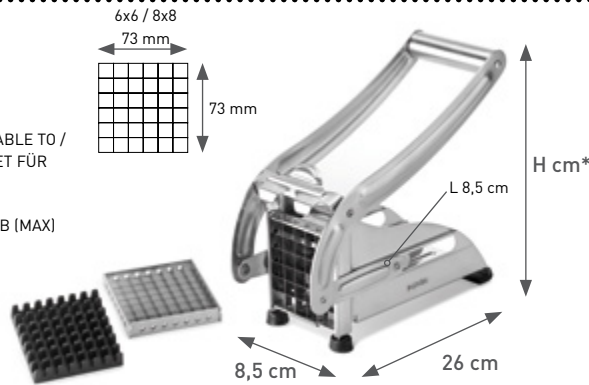

REF	CORTE / CUT COUPE / SCHNITT mm	AGUJEROS / HOLES / TROUS / LÖCHER	U
P975.000	12 / 9	36 / 64	1

\*H 30 cm ABIERTO / OPEN / OUVERT / OFFEN  
\*H 13 cm CERRADO / CLOSED / FERMÉ / GESCHLOSSEN

CUCHILLA DE REEMPLAZO / REPLACEMENT BLADE ITEM /  
LAME DE RECHARGE / ERSATZMESSER

REF	CORTE / CUT COUPE / SCHNITT mm	AGUJEROS / HOLES / TROUS / LÖCHER	U
RE 975.001	12	36 (6 x 6)	1
RE 975.002	9	64 (8 x 8)	1

**P9751** Cortador de patatas fritas en acero y plástico / St/Steel and plastic french fry cutter / Coupe frites en acier inox et plastique / Pommesschneider aus Plastik und rostfrei

ADAPTABLE A / ADJUSTABLE TO /  
ADAPTABLE À / GEEIGNET FÜR

FUERA / OUTSIDE /  
EXTÉRIEUR / AUßERHALB (MAX)  
1/1 65 mm

Con ventosas de agarre en la base.  
With suction base.  
Avec ventouse d'accrochement à la base.  
Mit Saugfüßen.

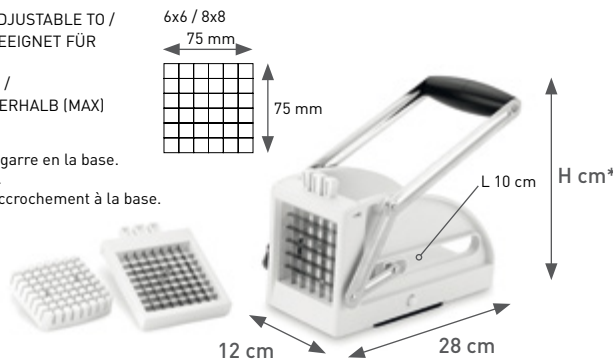

REF	CORTE / CUT COUPE / SCHNITT mm	AGUJEROS / HOLES / TROUS / LÖCHER	U
P975.100	13 / 9	36 / 64	1

\*H 30 cm ABIERTO / OPEN / OUVERT / OFFEN  
\*H 14 cm CERRADO / CLOSED / FERMÉ / GESCHLOSSEN

CUCHILLA DE REEMPLAZO / REPLACEMENT BLADE ITEM /  
LAME DE RECHARGE / ERSATZMESSER

REF	CORTE / CUT COUPE / SCHNITT mm	AGUJEROS / HOLES / TROUS / LÖCHER	U
RE 975.101	13	36 (6 x 6)	1
RE 975.102	9	64 (8 x 8)	1

**P390** Cortahuevos guitarra de acero inox / St/Steel egg slicer / Coupe-oeuf en acier inox / Eierschneider rostfrei

REF	cm	U
P390.000	7,7 x 9,4	1

**P3901** Cortahuevos doble uso / 2 way egg cutter / Coupe-oeuf 2 utilisations / 2 Weg Eierschneider

REF	cm	U
P390.100	11,5 x 9,5 x 3,5	1

**P610** Cortador y descorazonador manzanas / Apple cutter & corer / Vide et coupe pommes / Apfelschneider und Entherzer

REF	Ø cm	U
P610.000	8,5	1

Cuchilla en acero inoxidable y marco en aluminio de fundición  
St/Steel blades with cast aluminium frame  
Lames inox et manche en aluminium fonté  
Messer aus rostfreiem Stahl und Rahmen aus Aluminiumguss

**P938** Prensa ajos / Garlic Press / Presse-ail / Knoblauchpresse

REF	U
P938.000	1

Aluminio fundición  
Cast aluminium  
Fonté d'aluminium  
Aluminiumguss

**P9755** Mandolina corte "V" / "V" shaped mandoline slicer /  
"V" mandoline / "V" Gemüsehobel

PLÁSTICO / PLASTIC /  
PLASTIQUE / PLASTIK

Incluye: 2 cuchillas + 3 guías plástico arosor (1 mm / 2 mm / 3 mm) /  
Includes: 2 julienne blades + 3 thi  
Comprend: 2 lames julienne + 3 g  
Inklusive: 2 Klingen + 3 Schneidef

Pies goma antideslizantes.  
Non-slip rubber feet.  
Pieds en caoutchouc antidérapants.  
Rutschfeste Gummifüße.

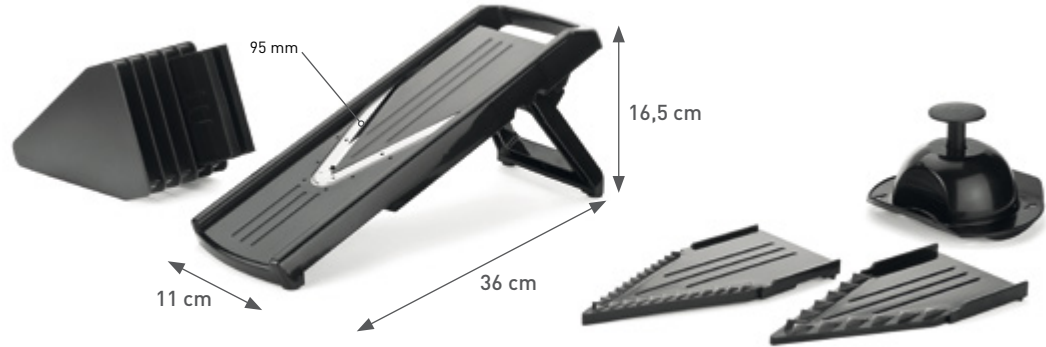
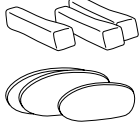

REF	CORTE / CUT COUPE / SCHNITT mm	CUCHILLAS / BLADES / LAMES / MESSER	U
P975.500	4 / 7	24 / 12	1

**9756** Mandolina / Mandoline / Mandoline / Mandoline

ACERO INOXIDABLE / ST/STEEL /  
ACIER INOXYDABLE / ROSTFREIER STAHL

Incluye: cuchilla giratoria + regulador de espesor corte (3, 6 y 9 mm) /  
Includes: rotating blades + thickness regulator (3, 6 and 9 mm) /  
Comprend: lames tournantes + regulateur épaisseur (3, 6 et 9 mm) /  
Inklusiv: drehbare Klinge + Breitenregulierer (3, 6 und 9 mm)

Rebanada, rebanada ondulada y bastoncillos.  
Slice, wavy slice and sticks.  
Tranches, ondulé tranches et bâtonnets.  
Scheib, crinkle scheid und stäbchen.

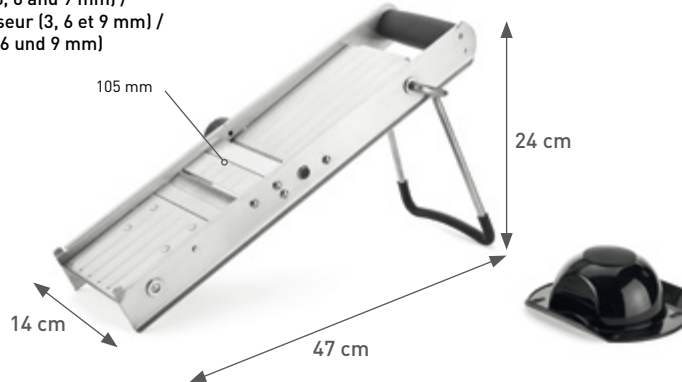
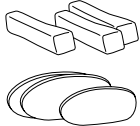

REF	CORTE / CUT COUPE / SCHNITT mm	CUCHILLAS / BLADES / LAMES / MESSER	U
P975.600	4 / 9	23 / 11	1

**1400** Descorazonador de tomates / Tomato corer / Permet d'ôter le coeur de la tomate / Tomatenentkerner

TOMATO KING®



REF	U
1400*	144
1401**	24

Dientes de acero inoxidable.  
Stainless steel teeth.  
Dents en inox.  
Edelstahlzähne.

\*Paquete a granel / Bulk pack /  
Paquet en vrac / Großpackung

\*\*Paquete estándar / Standard pack /  
Paquet standard / Standardpackung

**15149** Gel lubricante sanitario / Sanitary gel lubricant / Gel lubrifiant sanitaire / Medizinisches Gleitgel

PETROL GEL



REF	ml	U
15149	118	1

## TABLAS DE CORTE / CUTTING BOARDS / PLANCHES À DÉCOUPER / SCHNEIDBRETTER



ESPAÑOL

PRESENTAMOS UNA NUEVA GAMA DE TABLAS DE CORTE CON MÁS DE 20 MODELOS DISTINTOS Y MÁS DE 100 REFERENCIAS, CONCEBIDAS PARA SATISFACER TODAS LAS NECESIDADES DEL MERCADO. OFRECEMOS TAMBIÉN LA POSIBILIDAD DE FABRICAR MEDIDAS Y GROSORES ESPECIALES SOBRE PEDIDO. LA NUEVA GAMA DE TABLAS DE CORTE SE PRESENTA EN DOS MODALIDADES; UNAS FABRICADAS EN POLIETILENO (PE) POR INYECCIÓN Y LA GAMA MÁS EXTENSA EN POLIETILENO 500 ALTA DENSIDAD (HD PE 500) POR TERMOCOMPRESIÓN

ENGLISH

WE INTRODUCE HERE WITH THE NEW RANGE OF CUTTING BOARD WITH MORE THAN 20 DIFFERENT PARTERNS AND MORE THAN 100 REFERENCES CONCEIVED TO FULFILL ALL THE MARKET NEEDS. WE ALSO OFFER THE POSSIBILITY TO PRODUCE SPECIAL SIZES AND THICKNESSES UPON REQUEST. THIS NEW RANGE OF CUTTING BOARDS IS PRESENTED IN TWO DIFFERENT MATERIALS, ONE MADE OF POLYETHYLENE (PE) USING THE INJECTION TECHNIQUE AND THE WIDEST RANGE ON HIGH DENSITY POLYETHYLENE 500 (HD PE 500) THROUGH THERMO COMPRESSION.

FRANÇAIS

NOUS PRÉSENTONS UNE NOUVELLE GAMME DE PLANCHES À DÉCOUPER AVEC PLUS DE 20 MODÈLES DIFFÉRENTS ET PLUS DE 100 RÉFÉRENCES, CONÇUES POUR SATISFAIRE TOUS LES BESOINS DU MARCHÉ. NOUS OFFRONS AUSSI LA POSSIBILITE DE FABRIQUER DES PLANQUES AVEC DES MESURES ET DES ÉPAISSEURS SPÉCIALES SUR COMMANDE. CETTE NOUVELLE GAMME DE PLANCHES À DÉCOUPER SE PRÉSENTENT EN DEUX MATERIAUX DIFFÉRENTS: CERTAINES SONT PRODUITES EN POLYÉTHYLÈNE (PE) PAR INJECTION ET LA MAJORITÉ DE LA GAMME EST PRODUITE EN POLYÉTHYLÈNE 500 DE HAUTE DENSITÉ (HD PE 500) PAR THERMO COMPRESSION.

DEUTSCH

WIR PRÄSENTIEREN EINE NEUE PRODUKTREIHE VON SCHNEIDEBRETTERN MIT MEHR ALS 20 VERSCHIEDENEN MODELLEN UND ÜBER 100 ARTIKEL, UM DIE BEDÜRFNISSE DES MARKTS ZUFRIEDEN ZU STELLEN. WIR BIETEN AUCH DIE MÖGLICHKEIT SPEZIELLE MASSE UND DICKE HERZUSTELLEN ABHÄNGIG VON DER BESTELLUNG. DIE NEUE PRODUKTREIHE BIETEN WIR IN ZWEI VERSCHIEDENEN VARIANTEN AN: EINE VARIANTE HERGESTELLT AUS POLYETHYLEN (PE) DURCH SPRITZVERFAHREN UND DIE BREITESTE PRODUKTVARIANTE HERGESTELLT AUS POLYETHYLEN 500 HOHE DICHT (HD PE 500) DURCH WÄRMEDRUCKVERFAHREN.



PESCADO CRUDO  
RAW FISH  
POISSON CRU  
ROHER FISCH



PAN Y LACTEOS  
BAKERY & DAIRY  
PAIN ET PRODUITS LAITIERS  
BROT UND  
MILCHPRODUKTE



CARNE GUISADA  
COOKED MEAT  
VIANDE CUISINÉE  
GEKOCHTES FLEISCH



FRUTA & VEGETALES  
FRUIT & VEGETABLES  
FRUIT ET LÉGUMES  
OBST & GEMÜSE



CARNE CRUDA  
RAW MEAT  
VIANDE CRU  
ROHES FLEISCH



CARNE CRUDA DE AVES  
RAW POULTRY & CHICKEN  
VIANDE CRU ET VOLAILLES  
ROHES GEFLÜGEL



## &gt; CARACTERÍSTICAS PRINCIPALES

Las tablas de corte fabricadas en Polietileno 500 alta densidad, se caracterizan por un alto peso molecular (HMWPE) ofreciendo:

- Alta DURABILIDAD
- 25% más resistencia a la ABRASIÓN.
- Mayor temperatura de fusión: 135,4 °C.
- Temperatura de reblandecimiento 83 °C
- Mayor RIGIDEZ

\* No presentan deformación durante el aclarado del ciclo de lavado en lavavajillas industriales (temp. máx. aprox. 80 °C)

Conforme a las normativas siguientes:

RD 1712/91 registro sanitario de alimentos CE 1935/2004.

## &gt; MAIN FEATURES

The cutting boards made of High Density Polyethylene 500 have higher molecular weight (HMWPE), offering the following properties:

- High DURABILITY
- 25% more resistance to ABRASION
- Higher Fusion temperature: 135,4 °C
- Softening temperature: 83 °C
- Extraordinary RIGIDNESS

\* Do not present deformation during the rinsing process of industrial dishwasher cleaning cycle (max. temp. aprox. 80 °C).

Following the CE 1935/2004 regulation.

## &gt; CARACTÉRISTIQUES PRINCIPALES

Les planches à découper fabriquées en Polyéthylène 500 haute densité ont un poids moléculaire (HMWPE) plus grand qui offre les suivantes propriétés:

- Longue DURÉE
- 25% plus résistant à l'ABRASION
- Température de fusion: 135,4 °C
- Température de ramollissement: 83 °C
- RIGIDITÉ maximale

\* Ne présente pas de déformation lors du cycle lavage dans le lave-vaisselles industriel (Temp. max. aprox. 80 °C).

Conforme à la réglementation 1935/2004.

## &gt; Haupteigenschaften

Die Schneidbretter hergestellt aus Polyethylen 500 hohe Dichte haben ein höheres Molekulargewicht (HMWPE), mit folgenden Eigenschaften:

- Hohe Langlebigkeit
- 25% höherer Verschleisswiderstand
- Höhere Schmelztemperatur: 135,4 °C
- Erweichungstemperatur: 83 °C
- Extrahohe Starrheit

\* Es treten keine Verformungen beim Spülvorgang in industriellen Spülmaschinen auf (max. Temp. ca. 80 °C).

Entsprechend der Norm CE 1935/2004.



## P9112



Con pies silicona  
With silicon feet  
Avec pieds en silicone  
Mit Silikonfüßen

REF	Color	mm	H mm	U
P911.201		400 x 300	20,0	1
P911.202		600 x 400	20,0	1

## P9113 GN 1/1



Con ranura  
With groove  
Avec rigole  
Mit Fuge

REF	Color	mm	H mm	U
P911.301		530 x 325	20,0	1
P911.302		530 x 325	20,0	1
P911.303		530 x 325	20,0	1
P911.304		530 x 325	20,0	1
P911.305		530 x 325	20,0	1
P911.306		530 x 325	20,0	1

## P9118

300 x 200 x 20



Con pies silicona  
With silicon feet  
Avec pieds en silicone  
Mit Silikonfüßen

REF	Color	mm	H mm	U
P911.801		300 x 200	20,0	1
P911.802		300 x 200	20,0	1
P911.803		300 x 200	20,0	1
P911.804		300 x 200	20,0	1
P911.805		300 x 200	20,0	1
P911.806		300 x 200	20,0	1

## P9117 GN 1/2

320 x 265 x 20



Con pies silicona  
With silicon feet  
Avec pieds en silicone  
Mit Silikonfüßen

REF	Color	mm	H mm	U
P911.701		320 x 265	20,0	1

## P9120

400 x 200 x 20



Con pies silicona  
With silicon feet  
Avec pieds en silicone  
Mit Silikonfüßen

REF	Color	mm	H mm	U
P912.001		400 x 200	20,0	1

## P9114

400 x 300 x 20



Con pies silicona  
With silicon feet  
Avec pieds en silicone  
Mit Silikonfüßen

REF	Color	mm	H mm	U
P911.401		400 x 300	20,0	1
P911.402		400 x 300	20,0	1
P911.403		400 x 300	20,0	1
P911.404		400 x 300	20,0	1
P911.405		400 x 300	20,0	1
P911.406		400 x 300	20,0	1

## TABLAS DE CORTE / CUTTING BOARDS / PLANCHES À DÉCOUPER / SCHNEIDBRETTER

**P9119**

500 x 300 x 20



Con pies silicona  
With silicon feet  
Avec pieds en silicone  
Mit Silikonfüssen

REF	Color	mm	H mm	U
P911.901	White	500 x 300	20,0	1
P911.902	Red	500 x 300	20,0	1
P911.903	Blue	500 x 300	20,0	1
P911.904	Yellow	500 x 300	20,0	1
P911.905	Green	500 x 300	20,0	1
P911.906	Brown	500 x 300	20,0	1

**P9115 GN 1/1**

530 x 325 x 20



Con pies silicona  
With silicon feet  
Avec pieds en silicone  
Mit Silikonfüssen

REF	Color	mm	H mm	U
P911.501	White	530 x 325	20,0	1
P911.502	Red	530 x 325	20,0	1
P911.503	Blue	530 x 325	20,0	1
P911.504	Yellow	530 x 325	20,0	1
P911.505	Green	530 x 325	20,0	1
P911.506	Brown	530 x 325	20,0	1

**P9116**

600 x 400 x 20



Con pies silicona  
With silicon feet  
Avec pieds en silicone  
Mit Silikonfüssen

REF	Color	mm	H mm	U
P911.601	White	600 x 400	20,0	1
P911.602	Red	600 x 400	20,0	1
P911.603	Blue	600 x 400	20,0	1
P911.604	Yellow	600 x 400	20,0	1
P911.605	Green	600 x 400	20,0	1
P911.606	Brown	600 x 400	20,0	1

**P9135 Bar**

Sin pies  
Without feet  
Sans pieds  
Ohne Füße

REF	Color	mm	H mm	U
P913.501	White	160 x 250	10,0	1
P913.601	White	250 x 200	10,0	1
P913.701	White	300 x 200	10,0	1
P913.901	White	320 x 240	10,0	1

**P901** Recogeverduras inox / St/Steel vegetable picker /  
Pelle à légumes inox / Gemüsehacker rostfrei

REF	cm	U
P901.014	14 x 10	1
P901.018	18 x 12	1

**P9130** Mesa de corte / Cutting board table /  
Table de découpe / Schneidtisch

Con ranura  
With groove  
Avec rigole  
Mit Fuge

No incluye contenedor Gastronorm  
Delivered without the GN container  
Livré sans le bac GN  
Ausschliesslich GN Behälter

REF	Color	mm	H mm	U
P913.000	White	650 x 400	110,0	1

Para almacenar alimentos recién cortados en cubeta GN 1/3  
Perfect for storing direct cut products into a 1/3 GN pan  
Permet découper les produits directement au dessus du bac Gastronorme 1/3  
Für die Aufbewahrung von frischgeschnittenen Lebensmitteln im Behälter GN 1/3

VER PRODUCTOS EN / SEE PRODUCTS ON /  
VOIR PRODUITS EN PAGE / SIEHE PRODUKTE IN

Antialérgico / Allergen-Free /  
Anti allergique / Anti allergie

P. 84

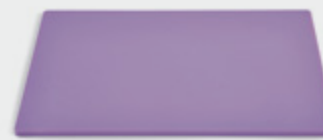





### P600 Balanza mecánica / Mechanical scale / Balance automatique / Mechanische Waage



REF	kg	Grs	U
P600.005	5	20	1

Cuerpo y bandeja de acero inox.  
Bandeja superior plana con botón regulador.  
Body and upper flat platform in St/Steel with regulation button.  
Corps et plate-forme plane supérieure en inox. Bouton de régulation.  
Körper und Plattform aus rostfreiem Stahl.  
Ebene obere Plattform mit regulierbarem Knopf.

### P601 Balanza mecánica / Mechanical scale / Balance automatique / Mechanische Waage



REF	kg	Grs	U
P601.010	10	50	1

Cuerpo y bandeja de acero inox.  
Bandeja superior plana con botón regulador.  
Body and upper flat platform in St/Steel with regulation button.  
Corps et plate-forme plane supérieure en inox. Bouton de régulation.  
Körper und Plattform aus rostfreiem Stahl.  
Ebene obere Plattform mit regulierbarem Knopf.

### P602 Balanza mecánica / Mechanical scale / Balance automatique / Mechanische Waage



REF	kg	Grs	U
P602.015	15	50	1

Cuerpo y bandeja de acero inox.  
Bandeja superior bombeada con botón regulador.  
Body and upper conical platform in St/Steel with regulation button.  
Corps et plate-forme bombée supérieure en inox. Bouton de régulation.  
Körper und Plattform aus rostfreiem Stahl.  
Halbkugelige obere Plattform mit regulierbarem Knopf.

### P609 Balanza digital / Electronic scale / Balance électronique / Digitale Waage

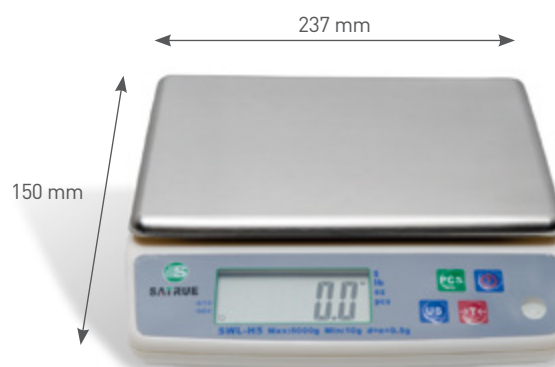

REF	Kg	Grs	U
P609.010	10	2	1

Alta precisión y rendimiento / Multifunción de peso y contador.  
High accuracy and performance / Multi-function weighting and counting both ability.  
Haute précision et performance / Multi-fonction de poids et compteur.  
Hohe Genauigkeit und Performenz/ Multi-Funktion Wiegen und Zählen.



**P6092** Balanza digital / Digital kitchen scale /  
Balance électronique / Digitale Waage

NUEVO MODELO /  
NEW MODEL /  
NOUVEAU MODÈLE /  
NEUES MODELL



REF	kg	d (g)	U
P609.200	15	1	1

Plataforma en acero inoxidable. Pantalla LED.  
Surface made of St/Steel. LED Display.  
Plateau fabriquée en acier inoxydable. Scran LED.  
Plattform rostfrei. LED Display.

**P611** Reloj de cocina digital / Kitchen timer alarm /  
Minuteur de cuisine / Digitale Küchenuhr



REF	cm	U
P611.000	6,8 x 6,8 x 2,5	1

**P9800** Termómetro nevera. Acabado esmaltado /  
Cold storage thermometer. Enameled finish /  
Thermomètre congélateur. Émaillé /  
Külschrankthermometer. Emailierte Ausfertigung



REF	L cm	Temp.	U
P980.000	28	-30 °C / +50 °C	1

**P6097** Balanza electrónica / Electronic kitchen scale /  
Balance électronique / Elektronische Waage



REF	Kg	Grs	Ø plat cm	U
P609.705	5	1	11	1

Gran precisión / Multifunción de peso / Contador de piezas / Sistema ahorro energía / Bandeja de plástico.  
High accuracy / Multi-function weight and counting / Energy-saving system / Plastic Platform.  
Haut précision / Multi-fonction des poids / Compteur des pièces / Système d'économie d'énergie / Plateau en plastique.  
Hohe Präzision / Multi-Funktion Wiegen / Stückzähler Energiesparsystem / Plattform Plastik.

**P9802** Termómetro de cocción con protección de plástico /  
Cooking thermometer with plastic protection /  
Thermomètre à cuisson avec gaine plastique /  
Kochthermometer mit Plastikschutz



REF	L cm	Temp. max.	U
P980.200	28	100 °C	1

**P98005** Termómetro nevera horizontal /  
Horizontal refrigerator thermometer /  
Thermomètre congélateur horizontal /  
Horizontales Külschrankthermometer



REF	mm	Temp.	U
P980.050	135 x 35	-40 °C / +20 °C	24

**P9816** Termómetro de cocción con protección de plástico /  
Cooking thermometer with plastic protection /  
Thermomètre à cuisson avec gaine plastique /  
Kochthermometer mit Plastikschutz .....



REF	L cm	Temp. max.	U
P981.600	17	-10 °C / +200 °C	1

**981650** Termómetro bolsillo con protección /  
Pocket thermometer with protection /  
Thermomètre de poche avec protection /  
Taschenthermometer mit Schutz .....



REF	L cm	Temp. max.	U
P981.650	14,3	-40 °C / +70 °C	24

**P9814** Termómetro digital / Digital thermometer /  
Thermomètre digital / Digitales Thermometer .....



REF	mm	Display mm	Temp.	U
P981.400	135 x 92 x 27	42 x 22	-20 °C / +200 °C	1

Con sonda de acero inoxidable.  
Protección antisalpicaduras. Con pantalla iluminada.  
La sonda esta sujeta al lateral del aparato.  
With St/Steel probe. Splash-proof. Illuminated display.  
Probe attached to side panel.  
Avec sonde inox. Etanche aux éclaboussures.  
Ecran illuminé. La sonde est attachée au côté lateral de l'appareil.  
Temperaturfühler aus rostfreiem Stahl  
Antispritzschutz. Beleuchtetes Display. Seitlicher Fühlerhalter.

**P9815** Termómetro digital de cocción con temporizador /  
Cooking thermometer with timer /  
Thermomètre à cuisson avec temporiseur /  
Digitales Kochthermometer mit Timer-Funktion .....



REF	L mm sonda + cable	Temp.	U
P981.500	90	0 °C / +200 °C	1

Plástico blanco. Base magnética para sujeción en superficies de metal.  
Temperatura/tiempo programable con señal de alarma.  
Sonda de acero inoxidable y cable alambre.  
White plastic. Magnetic base for attachment on metal surface. Programmable  
temperature/time, with alarm signal. St/Steel probe and wire cable.  
Plastique blanc. Base magnétique pour l'attacher à une surface métallique.  
Température/temps programmable avec sonnette d'alarme. Sonde inox et filet.  
Weisses Plastik. Magnetische Haftung für metallische Oberflächen.  
Temperatur/Zeit programmierbar mit Alarm. Rostfreier Fühler mit Drahtkabel.

**P9804** Termómetro infrarojos con mira laser / Infrared thermometer with laser pointer /  
 Thermomètre infra-rouge a visée laser / Infrarot Thermometer mit Laser Pointer



REF	Temp.	L cm	U
P980.400	-60 °C / +500 °C	17	1

Pantalla LCD  
 LCD Display  
 Écran LCD  
 LCD Display



Ideal para medir la temperatura de la superficie de los alimentos, sin contacto.  
 Non-contact temperature measure food's surface.  
 Idéal pour la mesure de température de surface des aliments, sans contact.  
 Ideal für Temperaturmessung von Lebensmittel ohne Berührung.

**P604** Jarra de medidas / Measuring jug /  
 Pot mesureur / Messbecher



REF	Lts	U
P604.001	1,00	1
P604.002	2,00	1

**P846** Jarra de medidas en polipropileno /  
 Polypropylene measuring jug /  
 Pot mesureur en polypropylène /  
 Messbecher aus Polypropylen



REF	Lts	U
P846.025	0,25	1
P846.050	0,50	1
P846.100	1,00	1
P846.200	2,00	1
P846.300	3,00	1

**P6045** Juego 4 cazos de medidas inox /  
 St/Steel 4 pcs set measuring cups /  
 Set 4 casseroles doseur /  
 4 teiliges Messkellenset rostfreies Stahl



REF	ml	U
P604.500	59 - 78 - 118 - 236	12

**P603** Cubo con base /  
 Bucket with base /  
 Seau avec base /  
 Eimer mit Skalierung



REF	Ø cm	H cm	Lts	U
P603.012	31	28,50	12,00	1
P603.015	32,5	32,50	15,00	1

## MANOPLA HORNO / OVEN MITT / GAN À FOUR / HANDSCHUHE

**P947** Manopla horno / Oven mitt / Gan à four / Handschuhe

REF	L cm	U
P947.033	33	1
P947.038	38	1
P947.043	43	1

100 % Algodón / Cotton / Coton / Baumwolle

Temp. Max. 220 °C

**P9471** Manoplas ignífugas con revestimiento silicona / Oven mitt flame retardant silicone coating / Moufles isolantes avec revêtement silicone / Feuerfester Backhandschuh mit Silikonbeschichtung

REF	L cm	U
P947.101	33	1
P947.102	38	1
P947.103	43	1

Se venden por pares  
Sold in pairs  
Vendues par paires  
Verkauf als Paar

Temp. Max. 220 °C

Exterior fabricadas en 100% algodón + revestimiento silicona por una cara  
Outer made of 100% cotton + silicon coating on one side  
Extérieur fabriquées en 100% cotton + revêtement en silicone par un coté  
Exterieur Herstellung aus 100% Baumwolle + einseitige Silikonbeschichtung

**P9473** Guantes protección térmica / Heat protection gloves / Gants protection thermique / Hitzehandschuh

REF	Talla / Size / Taille / Grösse	U
P947.301	S	1
P947.302	M	1
P947.303	L	1

Se venden por pares  
Sold in pairs  
Vendues par paires  
Verkauf im Paar

Fabricados con recubrimiento de nitrilo en el exterior y con forro interior de algodón y keviar jersey. Llevan un tratamiento Actifresh y Sanitized que los provee de protección contra los microorganismos los cuales pueden causar malos olores y riesgo de infecciones.

Outer nitril coated. Inner made of cotton and keviar jersey. They enjoy of Actifresh and Sanitized treatment to fight against micro organisms which can cause bad scents and risk of infections.

Fabriqués avec un revêtement de nitrile à l'extérieur. Interieur de coton et keviar jersey avec un traitement Actifresh et Sanitized qui les fournit de protection contre les microorganismes lesquels peuvent causer de mauvais odeurs et risque d'infections.

Exterieur Herstellung aus Nitril. Innen aus Baumwolle und Kevlar Jersey. Sie werden mit Aktiv-Frisch- und Sanitierungverfahren behandelt, um gegen die Mikroorganismen entgegenzuwirken, die ursächlich sind für schlechte Gerüche und ein Risiko für Infektionen sein können.



**P9477** Manopla silicona con funda algodón / Silicone oven glove with cotton cover /  
Gant silicone à fourreau coton / Silikonhandschuh mit Baumwollfutter

● - 60 °C / - 76 °F  
● + 260 °C / + 500 °F



REF	L cm	U
P947.700	42,5	1

**P9474** Manopla Silicona / Silicone oven mitt / Moufle en silicone / Silikonbackhandschuh



REF	L cm	U
P947.400	30	1

**P9475** Manopla silicona / Silicone mitten / Mouflette en silicone / Silikonbackhandschuh



REF	cm	U
P947.500	10,5 x 9	1

**P9476** Paño de silicona / Silicone pot-grabber / Torchon en silicone / Silikontuch

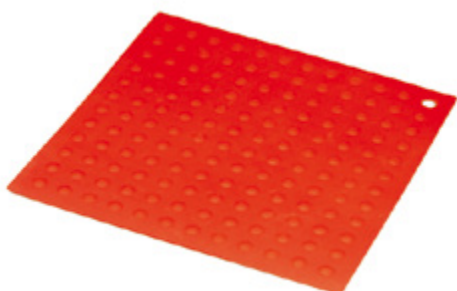

REF	cm	U
P947.600	17,6 x 17,6	1



BATERÍA COCINA FOODIES /  
FOODIES COOKWARE /  
BATTERIE CUISINE FOODIES /  
FOODIES KOCHBEDARF

<b>2.1</b>	PUJADAS 1921	130
<b>2.2</b>	BLACK SERIES	132
<b>2.3</b>	MULTIMETAL	136
<b>2.4</b>	COOL • LINE	138
<b>2.5</b>	IDEA	142
<b>2.6</b>	HOBBY CHEF	144
<b>2.7</b>	APARTAMENTO	146
<b>2.8</b>	UTENSILIOS DE COCINA / KITCHEN UTENSILS / USTENSILES DE CUISINE / KÜCHENUTENSILIEN	147

# FOODIES

**TÉRMINO INGLÉS QUE IDENTIFICA A LOS AMATEUR, AMANTES DE LA BUENA MESA, A LOS QUE LES ENCANTA LA COMIDA, SU ESTUDIO, SU PREPARACIÓN Y TODAS LAS NOTICIAS RELACIONADAS CON EL MUNDO DE LA GASTRONOMÍA. QUIEREN APRENDER TODO LO POSIBLE ACERCA DE LA COMIDA, TANTO LO MEJOR COMO LO COMÚN, Y DE LA CIENCIA, INDUSTRIA Y PERSONAJES QUE RODEAN AL MUNDO GASTRONÓMICO Y EN PUJADAS SE LO PONEMOS FÁCIL CON ESTE NUEVO CAPÍTULO /**

ENGLISH TERM USED TO DESCRIBE AMATEURS, LOVERS OF GOOD FOOD, ITS STUDY, ITS PREPARATION AND ALL THE NEWS RELATED TO THE WORLD OF GASTRONOMY. PEOPLE WHO WANT TO LEARN EVERYTHING ABOUT FOOD, BOTH THE BEST AS WELL AS THE MORE EVERY DAY, THE SCIENCE, INDUSTRY AND THE FIGURES INVOLVED IN THE GASTRONOMIC WORLD. PUJADAS MAKE IT EASIER WITH THIS NEW SECTION /

TERME ANGLAIS DÉSIGNANT LES AMATEURS ET PASSIONNÉS DE LA BONNE TABLE, LES ADEPTES DE LA BONNE CUISINE, CEUX QUI RAFFOLENT DE SON ÉTUDE, SA PRÉPARATION ET TOUTES LES NOUVELLES CONCERNANT LE MONDE DE LA GASTRONOMIE. CEUX QUI SOUHAITENT AUSSI CONNAÎTRE TOUT LES SECRETS CULINAIRES, DES PLUS SOPHISTIQUÉS AUX PLUS COMMUNS, AINSI QUE DE LA SCIENCE, DE L'INDUSTRIE ET DES PERSONNALITÉS QUI GRAVITENT DANS L'UNIVERS GASTRONOMIQUE. PUJADAS VOUS FACILITE LA TÂCHE AVEC CETTE NOUVELLE SECTION /

ENGLISCHER BEGRIFF UM AMATEURE ZU BESCHREIBEN, LIEBHABER VON GUTEM ESSEN, WELCHE SEINEM STUDIUM, SEINER VORBEREITUNG UND ALLER MIT DER WELT DER GASTRONOMIE VEBUNDENEN NACHRICHTEN GENIESSEN. LEUTE, DIE ALLES MÖGLICHE ÜBER DAS ESSEN LERNEN WOLLEN, SOWOHL DAS BESTE ALS AUCH DAS GEWÖHNLICHE, DIE WISSENSCHAFT, DIE INDUSTRIE UND PERSONEN, DIE SICH IN DER WELT DER GASTRONOMIE BEWEGEN. PUJADES MACHT ES IHNEN EINFACH MIT DIESEM NEUEN KAPITEL EINFACH.





FOODIES

	PUJADAS 1921	BLACK SERIES	MULTIMETAL	COOL • LINE	IDEA	HOBBY CHEF	APARTAMENTO
REF / ITEM / CODE / ART.NR.							
INDUCCIÓN / INDUCTION / INDUCTION / INDUKTION	✓✓✓	✓	✓✓	✓✓	✓✓	✓✓	✓✓
PRECIO / PRICE / PRIX / PREIS	€€	€€	€€€€€	€€€	€€€	€€€	€
GARANTÍA AÑOS / WARRANTY YEARS / GARANTIE ANNÉE / GARANTIE JAHRE	2	2	5	4	4	4	2
UTILIZACIÓN / USE / UTILISATION / GEBRAUCH	RÁPIDA Y POCO ACEITE / QUICK AND LITTLE OIL / RAPIDE ET PEU D'HUILE / SCHNELL UND WENIG ÖL	COCCIÓN LENTA / SLOW COOKING / CUISSON LENTE / LANGSAMES KOCHEN	ALTA COCINA / HIGH CUISINE / HAUTE CUISINE / HOHE KÜCHE	TODO USO / ALL-PURPOSES / TOUT TYPE DE CUISSON / GEEIGNET FÜR ALLE KÜCHENTYPEN	 ALL OVER TECH	TODO USO / ALL-PURPOSES / TOUT TYPE DE CUISSON / GEEIGNET FÜR ALLE KÜCHENTYPEN	USO DOMÉSTICO / HOME USE / USAGE DOMESTIQUE / HEIMGEBRAUCH
ANTIADHERENTE / NON-STICK COATING / ANTI-ADHÉSIF / ANTIHAFTBE- SCHICHTUNG			SARTENES Y WOKS / FRY PANS & WOKS / POÊLES ET WOKS / BRATPFANNEN & WOK				SARTENES / FRY PANS / POÊLES / BRATPFANNEN
TAPA / LID / COUVERCLE / DECKEL	CRISTAL INCLUIDA / GLASS LID INCLUDED / COUVERCLE EN VERRE INCLUS / INKL. GLASDECKEL	CRISTAL INCLUIDA / GLASS LID INCLUDED / COUVERCLE EN VERRE INCLUS / INKL. GLASDECKEL	INOX OPCIONAL / ST/STEEL LID OPTIONAL / COUVERCLE INOX EN OPTION / EDELSTAHLDECKEL OPTIONAL	TAPA INOX INCLUIDA / ST/STEEL LID INCLUDED / COUVERCLE INOX INCLUS / EDELSTA HLDECKEL INKL	TAPA INOX INCLUIDA / ST/STEEL LID INCLUDED / COUVERCLE INOX INCLUS / EDELSTA HLDECKEL INKL	TAPA INOX INCLUIDA / ST/STEEL LID INCLUDED / COUVERCLE INOX INCLUS / EDELSTA HLDECKEL INKL	TAPA INOX INCLUIDA / ST/STEEL LID INCLUDED / COUVERCLE INOX INCLUS / EDELSTA HLDECKEL INKL
MANGO / HANDLE / QUEUE / STIL	INOX RESISTENTE AL CALOR / ST/STEEL HEAT RESISTANT / INOX RÉSISTANT À LA CHALEUR / EDELSTAHL HITZEBESTÄNDIG	INOXIDABLE / ST/STEEL / INOXYDABLE / EDELSTAHL	INOXIDABLE / ST/STEEL / INOXYDABLE / EDELSTAHL	INOXIDABLE / ST/STEEL / INOXYDABLE / EDELSTAHL	INOXIDABLE / ST/STEEL / INOXYDABLE / EDELSTAHL	VARILLA INOX / INOX ST/STEEL WIRE / FIL INOX / EDELSTAHLDRAHT	BAQUELITA / BAKELITE / BAKÉLITE / BAKELIT
ASAS / HANDLES / ANSES / GRIFFE		MONOBLOC / ONE PIECE / MONOBLOC / MONOBLOCK		FUNDICIÓN / CAST / FONTE / GUSSEISEN			

# PUJADAS 1921

PARA UNA COCINA RÁPIDA Y SANA, PERMITE COCINAR CARNES, PESCADOS Y VERDURAS A FUEGO ALTO, USANDO MUY POCO ACEITE /

FOR A QUICK AND HEALTHY COOKING, IT ENABLES YOU TO COOK MEATS, FISH, VEGETABLES USING HIGH HEAT AND VERY LITTLE OIL /

POUR UNE CUISINE RAPIDE ET SAINTE, PERMETTANT DE CUISINER LES VIANDES, POISSONS ET LÉGUMES À FEU VIF, EN UTILISANT TRÈS PEU D'HUILE /

FÜR EINE SCHNELLE UND GESUNDE KÜCHE, ERLAUBT FLEISCH, FISCH UND GEMÜSE AUF HOHER FLAMME MIT WENIG ÖL ZU BRATEN.

VERDURAS CRUJIENTES Y CARNES TIERNAS, EN CUALQUIER TIPO DE COCINAS, ESPECIALMENTE INDUCCIÓN /

CRUNCHY VEGETABLES, TENDER MEATS, SUITABLE FOR ALL TYPES OF CUISINES, ESPECIALLY INDUCTION /

LÉGUMES CROQUANTS, VIANDES TENDRES, TOUT TYPE DE CUISINIÈRES, NOTAMMENT L'INDUCTION /

KNUSPRIGES GEMÜSE UND ZARTES FLEISCH, IN ALLEN KÜCHENTYPEN, SPEZIELL INDUKTION.



BATERÍA DE ACERO DE FUNDICIÓN LIGERO DE FÁCIL MANEJO /  
LIGHT CAST STEEL COOKWARE EASY TO USE /  
BATTERIE EN FONTE D'ACIER LÉGER, FACILE À MANIPULER /  
GESCHIRR AUS LEICHTEM GUSSEISEN FÜR EINE EINFACHE HANDHABUNG

40% MENOS DE PESO QUE LAS SARTENES DE HIERRO TRADICIONAL /  
40% LESS WEIGHT THAN TRADITIONAL IRON PANS /  
40% DE POIDS EN MOINS PAR RAPPORT AUX POÊLES  
EN FER TRADITIONNELLES /  
40% WENIGER GEWICHT ALS DIE TRADITIONELLEN EISENBRATPFANNEN

TAPA DE CRISTAL INCLUIDA /  
GLASS LID INCLUDED /  
COUVERCLE EN VERRE INCLUS /  
GLASDECKEL INKLUSIVE



MANGO ERGONÓMICO, RESISTENTE AL CALOR /  
HEATPROOF ERGONOMIC HANDLE /  
MANCHE ERGONOMIQUE, RÉSISTANT À LA CHALEUR /  
HITZBESTÄNDIGER ERGONOMISCHER GRIFF

EXTRAORDINARIAS PROPIEDADES CALÓRICAS.  
EXCELENTE Y HOMOGÉNEA DISTRIBUCIÓN DEL CALOR /

EXTRAORDINARY CALORIC PROPERTIES. EXCELLENT  
AND UNIFORM HEAT DISTRIBUTION /

PROPRIÉTÉS CALORIQUES EXTRAORDINAIRES.  
EXCELLENT ET HOMOGÈNE DISTRIBUTION DE LA CHALEUR /

AUSSERGEWÖHNLICHE KALORISCHE EIGENSCHAFTEN  
EXZELLENT UND GLEICHMÄSSIGE HITZEVERTEILUNG

TRES CAPAS DE ANTIADHERENTE DE ÚLTIMA GENERACIÓN, LIBRE DE PFOA /  
LAST GENERATION THREE LAYERS NON-STICK COATING. PFOA FREE /  
TROIS COUCHE ANTI-ADHÉSIVE DE DENIÈRE GÉNÉRATION. LIVRE DE PFOA /  
DREIFACHE ANTIHAFTBESCHICHTUNG DER NEUESTEN GENERATIONEN. PFOA FREI

**P169** Sartén / Fry pan / Poêle / Bratpfanne



REF	Ø cm	H cm	U
P169.020	20	4,5	1
P169.024	24	4,5	1
P169.028	28	5,5	1
P169.030	30	5,5	1

Paellera sin tapa /  
Paella pan without lid /  
Plat à paella sans couvercle /  
Paellapfanne ohne Deckel



REF	Ø cm	H cm	Lts	U
P165.024	24	3,0	1,20	1
P165.030	30	3,0	1,90	1
P165.034	34	3,0	2,30	1

Wok con tapa /  
Wok with lid /  
Wok avec couvercle /  
Wok mit Deckel



REF	Ø cm	H cm	Lts	U
P166.032	32	8,0	4,40	1

**P166V** Wok cónico con tapa /  
Conical wok with lid /  
Wok conique avec couvercle /  
Konischer Wok mit Deckel



REF	Ø cm	H cm	Lts	U
P166.032V	32	8,0	4,0	1

**P167** Cazuela alta con tapa /  
Deep casserole with lid /  
Braising with lid /  
Hohe Kasserolle mit Deckel



REF	Ø cm	H cm	Lts	U
P167.026	26	10,0	3,40	1
P167.028	28	11,0	3,75	1
P167.030	30	12,0	4,20	1
P167.032	32	13,0	6,00	1

**P168** Cazuela baja con tapa /  
Shallow casserole with lid /  
Faitout avec couvercle /  
Flache Kasserolle mit Deckel



REF	Ø cm	H cm	Lts	U
P168.024	24	6,0	2,00	1
P168.028	28	7,0	3,00	1
P168.030	30	8,0	3,80	1

BATERÍA COCINA FOODIES /  
FOODIES COOKWARE /  
BATTERIE CUISINE FOODIES







ALUMINIO DE FUNDICIÓN. FONDO INDESTRUCTIBLE / CAST ALUMINIUM. INDESTRUCTIBLE BASE / FONTE D'ALUMINIUM. FOND INDESTRUCTIBLE / ALUMINIUMGUSS. UNTERBODEN UNZERSTÖRBAR



**P1491** Sartén mango inox / Fry pan st/steel handle / Poêle manche inox / Bratpfanne Edelstahlgriff



REF	Ø cm	H cm	U
P149.120	20	5,0	4
P149.124	24	5,0	4
P149.128	28	5,0	4
P149.130	30	5,0	4

**P1492** Sartén honda mango inox / Deep fry pan st/steel handle / Poêle haute manche inox / Hohe Bratpfanne Edelstahlgriff



REF	Ø cm	H cm	U
P149.228	28	7,5	4

**P1493** Wok mango inox / Wok st/steel handle / Wok manche inox / Wok Edelstahlgriff



REF	Ø cm	H cm	U
P149.330	30	9,5	4

**P1501** Sartén crêpes mango inox / Crêpe fry pan st/steel handle / Poêle à crêpes manche inox / Crêpepfanne Edelstahlgriff



REF	Ø cm	H cm	U
P150.128	28	1,5	4

**P1421** Asador grill mango inox / Grill st/steel handle / Grill manche inox / Grillpfanne Edelstahlgriff



REF	cm	H cm	U
P142.100	28 x 28	4,0	4

## BLACK SERIES



Fondo torneado  
Ground base  
Fond dressé  
Gedrehter Unterboden

ESPAÑOL

GAMA DE ALUMINIO DE FUNDICIÓN TOTALMENTE INDEFORMABLE.

ENGLISH

RANGE OF CAST ALUMINIUM INDEFORMABLE.

FRANÇAIS

GAMME EN FONTE D'ALUMINIUM INDEFORMABLE.

DEUTSCH

PRODUKTSERIE AUS ALUMINIUMGUSS ABSOLUT UNVERFORMBAR.

### P155 Rustidera ovalada con tapa vidrio / Oval dish with glass lid / Cocotte avec couvercle / Co-cotte mit Deckel



REF	cm	H cm	U
P155.032	32 x 23	10,5	1

Tapa Pyrex transformable en bandeja de servicio.  
Pyrex cover that converts into serving tray.  
Couvercle Pyrex transformable en plateau de service.  
Pyrex-Deckel, auch als Schale verwendbar.



### P141 Cazuela baja sin tapa / Shallow casserole without lid / Cocotte sans couvercle / Flache Kasserolle ohne Deckel



REF	Ø cm	H cm	U
P141.020 *	20	5,5	1
P141.024	24	5,8	1
P141.028	28	7,5	1
P141.032	32	8,0	1
P141.036	36	8,5	1
P141.040	40	10,0	1

\*MINI-SIZE



**IDEA!**

Ideal para presentación. Ver en pàg. 138 de Vollrath  
Ideal for food presentation. See page 138 of Vollrath  
Idéal pour présentation. Voir page 138 de Vollrath  
Ideal für die Präsentation. Siehe seite 138 Vollrath

### P151 Cazuela alta sin tapa / Deep casserole without lid / Braisière sans couvercle / Hohe Kasserolle ohne Deckel



REF	Ø cm	H cm	U
P151.016 *	16	8,0	1
P151.020	20	9,0	1
P151.024	24	10,0	1
P151.028	28	12,0	1
P151.032	32	14,0	1

\*MINI-SIZE



**IDEA!**

Ideal para presentación. Ver en pàg. 138 de Vollrath  
Ideal for food presentation. See page 138 of Vollrath  
Idéal pour présentation. Voir page 138 de Vollrath  
Ideal für die Präsentation. Siehe seite 138 Vollrath

**P152** Rustidera / Roast pan / Plaque à rôtir / Bräter



REF	cm	H cm	U
P152.025 *	25 x 20	6,5	1
P152.030	30 x 22	7,0	1
P152.035	35 x 25	7,5	1

**IDEA!**

**\*MINI-SIZE**

Ideal para presentación  
Ideal for food presentation  
Idéal pour présentation  
Ideal für die Präsentation



**P153** Parrilla plana con asas / Hot-plate with handles / Grill plat avec poignées / Flache Bratplatte mit Griffen



REF. 153.025



REF. 153.050



REF.153.034

REF	cm	H cm	U
P153.025	25 x 25	2,0	1
P153.034	34 x 26	2,5	1
P153.050	50 x 30	2,5	1



**P150** Sartén crêpes mango baquelita / Crêpe fry pan bakelite handle / Poêle à crêpes manche bakélite / Crêpepfanne mit Bakelitstiel



REF	Ø cm	H cm	U
P150.028	28	2,0	12



**P142** Asador grill mango madera / Grill wooden handle / Grill queue en bois / Grillpfanne mit Holzstiel



REF	cm	H cm	U
P142.000	29 x 29	4,3	5



MULTIMETAL / MULTI-PLY / MULTI-METAL / MULTIMETALL

# MULTIMETAL

APORTA TODAS LAS VENTAJAS DEL ALUMINIO Y DEL ACERO INOXIDABLE EN UNA SOLA PIEZA /

IT GETS ALL ADVANTAGES OF THE ALUMINIUM AND THE ST/STEEL JUST IN ONE /

APPORTE TOUS LES AVANTAGES DE L'ALUMINIUM ET DE L'ACIER INOXYDABLE EN UNE SEULE PIÈCE /

BIETET ALLE VORTEILE VON ALUMINIUM UND EDELSTAHL IN EINEM EINZIGEN STÜCK



MANGOS TOTALMENTE ABIERTOS Y AISLANTES DEL CALOR /  
HEAT INSULATED OPEN LONG HANDLES /  
QUEUES TOTALEMENT OUVERTES ET ISOLANTES /  
STIELE TOTAL OFFEN UND HITZEISOLIERT



## TRANSMISIÓN TÉRMICA

El MULTIMETAL (5 capas) asegura una perfecta y homogénea distribución de la temperatura por toda la pieza.

Muy apta para PREPARADOS de cocción delicada: Elaboración de salsas, cremas, chocolate, etc. Extremadamente eficiente (20% menos tiempo y energía). Máximo rendimiento en todo tipo de cocinas ya sean GAS, VITROCERÁMICAS, ELÉCTRICAS o INDUCCIÓN.

## HEAT TRANSMISSION

The homogenous heat transmission on the entire body makes the MULTIMETAL cookware 5 PLY highly recommended for the elaboration of sauces, chocolate, creams, etc.

Extremely efficient (20% less time and energy). Highest performance on all kind of stoves, Either GAS, VITROCERAMIC, ELECTRIC and above all INDUCTION.

## REPARTITION DE LA CHALEUR

LE MULTI-METAL (5-COUCHES) Assure une parfaite et homogène repartition de la chaleur dans tout le récipient. Idéal pour les cuissons délicates, élaboration de sauces, crèmes, chocolats, etc. Très efficient (20% moins de temps et D'énergie).

Haute performance sur tout type de cuisinières: GAZ, VITROCÉRAMIQUE, ÉLECTRIQUE et surtout INDUCTION.

## HITZE-VERTEILUNG

Das Multimetal (5 Schichten) gewährleistet eine perfekte und homogene Hitzeverteilung im ganzen Körper. Sehr geeignet für die Zubereitung von delikaten Speisen: Sossen, Cremes, Schokolade etc. Aussergewöhnliche Effizienz (20% weniger Zeit und Energie). Höchste Leistung in allen Küchentypen GAS, KOCHFELDER, ELEKTRISCH ODER INDUKTION.

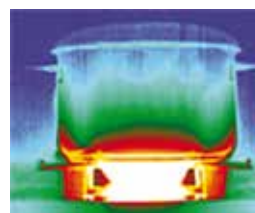

INOX - ST/STEEL ROSTFREIER STAHL



MULTIMETAL



## P238 Rustidera / Roast pan / Plaque à rôtir / Bräter



REF	cm	H cm	Lts	U
P238.120	35,3 x 25	6,0	3,25	1

GN 1/2

## P233/ P2331 Sautex / Sauté pan / Sauteuse / Sauteuse



REF	Ø cm	H cm	Lts	U
P233.024	24	6,0	2,50	1
P233.028	28	6,0	3,50	1
P233.032	32	6,0	4,50	1
P233.124*	24	6,0	2,50	1
P233.128*	28	6,0	3,50	1
P233.132*	32	6,0	4,50	1

\*ANTIADHERENTE / NON-STICK COATING /  
ANTI-ADHÉSIF / ANTIHAFTBESCHICHTUNG



## P234 Cazo bombeado / Rounded saucepan / Casserole bombée / Kugelige Stielkasserolle mit Schüttrand



REF	Ø cm	H cm	Lts	U
P234.016	16	6,5	1,20	1
P234.018	18	7,0	1,70	1
P234.020	20	7,5	1,80	1
P234.024	24	8,5	3,00	1
P234.028	28	10,0	5,50	1

## P251 Sartén antiadherente excalibur / Non-stick frypan excalibur / Poêle anti-adhésive excalibur / Excalibur Antihft Bratpfanne



REF	Ø cm	H cm	U
P251.020	20	4,0	1
P251.024	24	4,5	1
P251.028	28	5,0	1
P251.032	32	5,5	1

ANTIADHERENTE / NON-STICK COATING /  
ANTI-ADHÉSIF / ANTIHAFTBESCHICHTUNG



## P2390 / P2394 Wok fondo redondo / Round base wok / Wok à fond rond / Wok runder Boden



REF	Ø cm	H cm	Lts	U
P239.036	36	10,0	6,00	1
P239.436*	36	10,0	6,00	1

\*ANTIADHERENTE / NON-STICK COATING /  
ANTI-ADHÉSIF / ANTIHAFTBESCHICHTUNG



## P2391 / P2395 Wok fondo plano / Flat base wok / Wok à fond plain / Wok ebener Boden



REF	Ø cm	H cm	Lts	U
P239.136	36	9,0	5,50	1
P239.536*	36	9,0	5,50	1

\*ANTIADHERENTE / NON-STICK COATING /  
ANTI-ADHÉSIF / ANTIHAFTBESCHICHTUNG



COOL • LINE

# COOL • LINE

**CUERPO EN ACERO INOXIDABLE 18/10 /**  
 COOKWARE BODY MADE OF 18/10 STAINLESS STEEL /  
**CORPS EN ACIER INOXYDABLE 18/10 /**  
 KOCHBEDARF AUS EDELSTAHL 18/10

ASAS ERGONÓMICAS FABRICADAS EN ACERO INOXIDABLE DE FUNDICIÓN /  
 HERGONOMIC HANDLES MADE OF CAST ST/STEEL  
 ANSES EN FONTE D'ACIER INOXYDABLE, ERGONOMIQUES /  
 GRIFFE AUS GUSSEDELSTAHL HERGESTELLT. ABSOLUT ERGONOMISCH



PULIDO BRILLANTE /  
 MIRROR POLISHING /  
 POLISSAGE BRILLANT /  
 GLÄNZEND POLIERT

TAPA CON DISEÑO ESPECIAL PARA APOYO EN ASA LATERAL /  
 SPECIAL LID DESIGNED TO HOLD ON THE SIDE HANDLE /  
 COUVERCLE SPÉCIAL, CONÇU POUR REPOSER SUR LA POIGNÉE /  
 SPEZIELLES DECKELDESIGN ZUM HALTEN IM SEITENGRIF



FONDO TERMO DIFUSOR ENCAPSULADO /  
 ENCAPSULATED SANDWICH BASE /  
 FOND THERMO-DIFFUSEUR ENCAPSULÉ /  
 KAPSELFÖRMIGER THERMODIFFUSIONSUNTERBODEN



## P4908 Olla con tapa / Stock pot with lid / Marmite traiteur avec couvercle / Kochtopf mit Deckel



REF	Ø cm	H cm	Lts	U
P490.824	24	20,0	8,70	1
P490.828	28	28,0	13,60	1

**P4906** Cacerola alta con tapa / Sauce pot with lid / Braisière avec couvercle / Hohe Kasserolle mit Deckel



REF	Ø cm	H cm	Lts	U
P490.616	16	11,0	2,00	1
P490.620	20	13,0	3,70	1
P490.624	24	14,0	5,80	1
P490.628	28	16,0	9,50	1
P490.632	32	19,0	14,00	1

**P4907** Cacerola baja con tapa / Casserole with lid / Faitout avec couvercle / Flache Kasserolle mit Deckel



REF	Ø cm	H cm	Lts	U
P490.716	16	7,5	1,50	1
P490.720	20	8,0	2,50	1
P490.724	24	9,5	3,90	1
P490.728	28	11,0	5,80	1
P490.732	32	12,5	8,90	1

**P4900** Cazo recto / Saucepan / Casserole / Gerade Stielkasserolle



REF	Ø cm	H cm	Lts	U
P490.012	12	7,0	0,70	1
P490.014	14	7,0	1,00	1
P490.016	16	7,5	1,40	1
P490.018	18	9,0	2,10	1
P490.020	20	10,0	3,00	1

**P2371** Parte superior vaporera / Top for steam pot / Dessus cuit-vapeur / Oberteil Dampfgerar



REF	Ø cm	H cm	Lts	U
P237.120	20	13,0	4,00	1
P237.124	24	14,0	6,30	1

**P4902** Conjunto vaporera / Steam pot set / Cuit-vapeur / Dampfgerarset



REF	Ø cm	H cm	Lts	U
P490.220	A20	13,0	4,00	1
	B20	13,0	4,00	
P490.224	A24	14,0	6,30	1
	B24	14,0	6,30	

COOL • LINE

**P4906CO** Cacerola alta con tapa / Sauce pot with lid / Braisière avec couvercle / Hohe Kasserolle mit Deckel**EXCLUSIVE**

REF	Ø cm	H cm	Lts	U
P490.624 + COLOR	24	14,0	5,80	1
P490.628 + COLOR	28	16,0	9,50	1
P490.632 + COLOR	32	19,0	14,00	1



Ref. color /  
Ref. colour /  
Ref. couleur couvercle /  
Art.Nr. Farben

**P4907CO** Cacerola baja con tapa / Casserole with lid / Faitout avec couvercle / Flache Kasserolle mit Deckel**EXCLUSIVE**

REF	Ø cm	H cm	Lts	U
P490.732A	32	12,5	8,90	1
P490.732N	32	12,5	8,90	1
P490.732R	32	12,5	8,90	1
P490.732G	32	12,5	8,90	1



Ref. color /  
Ref. colour /  
Ref. couleur couvercle /  
Art.Nr. Farben







# IDEA COOKWARE

MUCHAS VECES LO MÁS IMPORTANTE ES LA IDEA /  
SO OFTEN, THE MOST IMPORTANT POINT IS THE IDEA /  
TRÈS SOUVENT, LE PLUS IMPORTANT C'EST L'IDÉE /  
OFTMALS IST DIE IDEE DAS WICHTIGSTE



INDUCTION



ESPAÑOL

BATERÍA ELEGANTE Y DE ATRACTIVO DISEÑO EN ACERO INOXIDABLE, CON FONDO DIFUSOR COMPACTO, APTO PARA INDUCCIÓN. FABRICADO A TRAVÉS DE UNA SOFISTICADA TECNOLOGÍA, ALL-OVER TECHNOLOGY, QUE PERMITE RELLENAR TODO EL INTERIOR DEL FONDO CON UNA ESPESA CAPA DE ALUMINIO, SIN DEJAR CAVIDADES VACÍAS Y PERMITIENDO UNA DIFUSIÓN DEL CALOR, MÁS RÁPIDA Y UNIFORME HASTA LOS BORDES DEL RECIPIENTE /

ENGLISH

ELEGANT AND ATTRACTIVELY DESIGNED COOKWARE IN STAINLESS STEEL, WITH COMPACT SANDWICH-BOTTOM, SUITABLE FOR INDUCTION. MANUFACTURED USING SOPHISTICATED ALL-OVER TECHNOLOGY, WHICH ENABLES THE ENTIRE INSIDE OF THE BASE TO BE FILLED WITH A THICK LAYER OF ALUMINIUM, WITHOUT LEAVING EMPTY CAVITIES. THIS MEANS HEAT DIFFUSION IS FASTER AND EVEN TO THE EDGES OF THE RECIPIENT /

FRANÇAIS

BATTERIE ÉLÉGANTE AU DESIGN ATTRACTIF EN ACIER INOXYDABLE, AVEC FOND DIFFUSEUR COMPACT, ADAPTÉE À L'INDUCTION. FABRIQUÉE GRÂCE À UNE TECHNOLOGIE SOPHISTIQUÉE - ALL-OVER TECHNOLOGY - PERMETTANT DE RECOUVRIR TOUT LE FOND INTÉRIEUR D'UNE ÉPAISSE COUCHE D'ALUMINIUM, SANS LAISSER DE CAVITÉS VIDES, POUR OFFRIR UNE DIFFUSION DE LA CHALEUR PLUS RAPIDE ET UNIFORME JUSQU'ÀUX BORDS DU RÉCIPIENT /

DEUTSCH

ELEGANTER KOCHBEDARF IM ATTRAKTIVEN DESIGN AUS EDELSTAHL, MIT KOMPAKTEM DIFFUSIONSUNTERBODEN, GEEIGNET FÜR INDUKTION. HERGESTELLT MIT EINER HOCHENTWICKELTEN TECHNOLOGIE, ALL-OVER TECHNOLOGY, DIE ES ERLAUBT DIE GANZE INNENSEITE DES UNTERBODENS MIT EINER DICKEN ALUMINIUMSCHICHT AUSZUFÜLLEN, OHNE BLASENENSTEHUNG, WELCHE EINE SCHNELLE BIS HIN ZU DEN RÄNDERN EINHEITLICHE WÄRMEVERTEILUNG ERLAUBT.

ALL-OVER TECHNOLOGY PROLONGA LA VIDA ÚTIL DE PRODUCTO, EVITANDO QUE SE ACUMULEN DENTRO DEL FONDO DIFUSOR RESTOS DE COMIDA, AGUA O DETERGENTES QUE LO ACABAN DAÑANDO /

ALL-OVER TECHNOLOGY IT PROLONGS THE USEFUL LIFE OF THE PRODUCT, PREVENTING REMAINS OF FOOD, WATER OR DETERGENTS ACCUMULATING IN THE SANDWICH BOTTOM AND EVENTUALLY DAMAGING IT /

ALL-OVER TECHNOLOGY PROLONGE LA DURÉE DE VIE UTILE DU PRODUIT EN ÉVITANT QUE NE S'ACCUMULENT DANS LE FOND DIFFUSEUR DES RESTES DE NOURRITURE, D'EAU OU DE DÉTERGENTS QUI FINISSENT PAR L'ENDOMMAGER /

ALL-OVER TECHNOLOGIE VERLÄNGERT DIE GEBRAUCHSDAUER DES PRODUKTS, SCHLIESST DAS ANLAGERN VON ESSENS-, WASSER- UND REINIGUNGSMITTELRESTEN AM BODEN AUS, WELCHE ES BESCHÄDIGEN.



INOX / ST/STEEL  
ROSTFREIER STAHL

ALUMINIO / ALUMINIUM

INOX MAGNÉTICO /  
MAGNETIC ST/STEEL /  
INOX MAGNÉTIQUE /  
MAGNETISCHER  
EDELSTAHL



**P458** Olla con tapa / Stock pot with lid / Marmite traiteur avec couvercle / Kochtopf mit Deckel



REF	Ø cm	H cm	Lts	U
P458.024	24	20,0	9,00	1
P458.028	28	24,0	14,50	1

**P456** Cacerola alta con tapa / Sauce pot with lid / Braisière avec couvercle / Hohe Kasserolle mit Deckel



REF	Ø cm	H cm	Lts	U
P456.016	16	11,0	2,00	1
P456.020	20	13,0	4,00	1
P456.024	24	14,0	8,50	1
P456.028	28	16,0	12,50	1
P456.032	32	19,0	15,20	1

**P457** Cacerola baja con tapa / Casserole with lid / Faitout avec couvercle / Flache Kasserolle mit Deckel



REF	Ø cm	H cm	Lts	U
P457.016	16	7,5	1,50	1
P457.020	20	8,0	2,50	1
P457.024	24	9,5	4,30	1
P457.028	28	11,0	6,70	1
P457.032	32	12,5	10,00	1

**P454** Cazo recto / Saucepan / Casserole / Gerade Stielkasserolle



REF	Ø cm	H cm	Lts	U
P454.012	12	7,0	0,70	1
P454.014	14	7,0	1,00	1
P454.016	16	7,5	1,50	1
P454.018	18	9,0	2,30	1
P454.020	20	10,0	3,10	1

**P459** Sartén / Fry pan / Poêle / Bratpfanne



REF	Ø cm	H cm	U
P459.018	18	4,0	1
P459.020	20	4,5	1
P459.024	24	5,0	1
P459.028	28	5,5	1



## HOBBY CHEF



ESPAÑOL

ESPECIALMENTE DISEÑADA PARA EL CHEF EN CASA O PARA PEQUEÑAS COCINAS PROFESIONALES DONDE EL ESPACIO ES CRUCIAL. ESTÁ FABRICADA EN ACERO INOXIDABLE 18/10, PULIDA SATINADA EN SU INTERIOR Y BRILLANTE EN EL EXTERIOR.

ENGLISH

SPECIALLY DESIGNED FOR AN INTENSIVE & PROFESSIONAL USE IN SMALL RESTAURANTS OR EVEN AT HOME. MADE OF 18/10 ST/STEEL STEEL INSIDE SATIN AND OUTSIDE MIRROR FINISH.

FRANÇAIS

SPÉCIALEMENT CONÇUE POUR UNE UTILISATION PROFESSIONNELLE INTENSIVE DANS DES PETITS RESTAURANTS OU AU NIVEAU PARTICULIER. FABRIQUÉE EN ACIER INOXYDABLE 18/10, POLISSAGE SATINÉ À L'INTÉRIEUR ET BRILLANT À L'EXTÉRIEUR.

DEUTSCH

SPEZIELL DESIGNT FÜR DEN CHEFF IM HAUS ODER KLEINE PROFESSIONELLE KÜCHEN, WO DER PLATZ ENTSCHEIDEND IST. HERGESTELLT AUS EDELSTAHL 18/10, INNEN SATINIERT UND AUSSEN GLÄNZEND POLIERT.

### P411

Olla recta con tapa / Stock pot with lid /  
Marmite traiteur avec couvercle /  
Gerader Kochtopf mit Deckel



REF	Ø cm	H cm	Lts	U
P411.524	24	20,0	8,70	1
P411.528	28	24,0	13,60	1

### P407

Cacerola baja con tapa / Casserole with lid /  
Faitout avec couvercle /  
Flache Kasserolle mit Deckel



REF	Ø cm	H cm	Lts	U
P407.516	16	7,5	1,50	1
P407.520	20	8,0	2,50	1
P407.524	24	9,5	3,90	1
P407.528	28	11,0	5,80	1
P407.532	32	12,5	8,90	1

### P408

Cacerola alta con tapa / Sauce pot with lid /  
Braisinge avec couvercle /  
Hohe Kasserolle mit Deckel



REF	Ø cm	H cm	Lts	U
P408.516	16	11,0	2,10	1
P408.520	20	13,0	4,00	1
P408.524	24	14,0	5,50	1
P408.528	28	16,0	9,00	1
P408.532	32	19,0	13,30	1

### P406

Paellera con tapa / Paella pan with lid /  
Plat à paella avec couvercle /  
Paellapfanne mit Deckel



REF	Ø cm	H cm	Lts	U
P406.524	24	6,0	2,70	1
P406.528	28	6,0	3,70	1



**P412** Parte superior vaporera / Top for steam pot /  
Dessus cuit-vapeur / Oberteil Dampfgarer



REF	Ø cm	H cm	Lts	U
P412.020	20	13,0	4,00	1
P412.024	24	14,0	5,50	1

Adaptable a olla y cacerola alta  
Adjustable to stock pot and sauce pot  
Adaptable à la marmite traiteur et à la braisière  
Aufsetzbar auf Kochtopf oder hohe Kasserolle

**P410** Sautex / Sauté pan / Sauteuse / Sauteuse



REF	Ø cm	H cm	Lts	U
P410.524	24	6,0	2,50	1

**P404** Cazo recto / Saucepan /  
Casserole / Gerade Stielkasserolle



REF	Ø cm	H cm	Lts	U
P404.512	12	7,0	0,70	1
P404.514	14	7,0	1,00	1
P404.516	16	7,5	1,40	1
P404.518	18	9,0	2,10	1
P404.520	20	10,0	3,00	1

**P305** Colador semiesférico /  
Round colander /  
Passoire demi-sphérique /  
Halbkugelförmiges Sieb



REF	Ø cm	U
P305.020	20	1
P305.022	22	1

**P470** Batería de cocina 8 piezas / 8 pieces kitchenware set /  
Batterie de cuisine de 8 pièces / 8 teiliges Kochset



REF	U
P470.005	1

Cacerola alta / Saucepot / Braisière / Hohe Kasserolle: 16, 20 cm  
Cacerola baja / Casserole / Faitout / Flache Kasserolle: 16, 20, 24 cm  
Cazos / Saucepans / Casseroles / Kasserolle: 14, 16 cm  
Sautex / Sauté pan / sauteuse / Sauteuse: 24 cm

## APARTAMENTO



Olla recta con tapa /  
Stock pot with lid /  
Marmite traiteur avec couvercle /  
Gerader Kochtopf mit Deckel

**P273**

REF	Ø cm	H cm	Lts	U
P273.024	24	20,0	9,00	1
P273.028	28	24,0	14,50	1

Cacerola baja con tapa /  
Casserole with lid /  
Faitout avec couvercle /  
Flache Kasserolle mit Deckel

**P271**

REF	Ø cm	H cm	Lts	U
P271.016	16	7,5	1,50	1
P271.020	20	8,5	2,50	1
P271.024	24	9,5	4,20	1
P271.028	28	11,0	6,50	1

**INDUCTION**

ESPAÑOL

BATERÍA ESPECIALMENTE IDEADA PARA EL EQUIPAMIENTO DE APARTAMENTOS, APART-HOTELES Y BUNGALOWS.

ENGLISH

COOKWARE SET ESPECIALLY DESIGNED FOR THE APARTMENTS, APART-HOTELS AND CABIN EQUIPMENT.

FRANÇAIS

BATTERIE DE CUISINE SPÉCIALEMENT CONÇUE POUR ÉQUIPER DES STUDIOS, APPART-HÔTELS ET BUNGALOWS.

DEUTSCH

KOCHBEDARF SPEZIELL DESIGNT VON FÜR DIE AUSSTATTUNG VON APARTEMENTS, APART-HOTELES UND BUNGALOWS.

Cacerola alta con tapa /  
Sauce pot with lid /  
Braisière avec couvercle /  
Hohe Kasserolle mit Deckel

**P270**

REF	Ø cm	H cm	Lts	U
P270.016	16	11,0	2,10	1
P270.020	20	14,5	4,50	1
P270.024	24	15,0	6,70	1
P270.028	28	16,0	9,50	1

Cazo / Saucepan /  
Casserole / Stielkasserolle

**P272**

REF	Ø cm	H cm	Lts	U
P272.014	14	7,5	1,10	1
P272.016	16	8,0	1,50	1
P272.018	18	8,5	2,10	1
P272.020	20	8,5	2,50	1

**P460** Sartén aluminio antiadherente. Mango baquelita / Aluminium non-stick fry pan. Bakelite handle / Poêle aluminium anti-adhésive. Queue en bakélite / Aluminiumbratpfanne Antihaft. Bakelitestiel



REF	Ø cm	H cm	U
P460.018	18	4,0	12
P460.020	20	4,0	12
P460.022	22	4,0	12
P460.024	24	4,0	12
P460.026	26	4,5	12
P460.028	28	4,5	12
P460.030	30	4,5	12
P460.032	32	5,0	12

UTENSILIOS DE COCINA / KITCHEN UTENSILS / USTENSILES DE CUISINE / KÜCHENUTENSILIEN

**P34001** Cacillo /  
Ladle /  
Louche /  
Schöpflöffel

Nylon



REF	L cm	Lts	U
P340.010	28,5	0,08	12

**P34002** Espumadera /  
Skimmer /  
Écumoire /  
Schaumlöffel

Nylon



REF	L cm	Ø cm	U
P340.020	27	10,7	12

**P34003** Cuchara de servicio /  
serving spoon /  
Cuillère de service /  
Servierlöffel

Nylon



REF	L cm	U
P340.030	27,5	12

**P34004** Espátula /  
Turner /  
Spatule /  
Pfannenwender

Nylon



REF	L cm	U
P340.040	28,5	12

**P34005** Espátula wok /  
wok spatula /  
Spatule wok /  
Wokspachtel

Nylon



REF	L cm	U
P340.050	27,5	12

**P34006** Espátula pastelera /  
baker spatula /  
Palette /  
Kuchenheber

Nylon



REF	L cm	U
P340.060	29	12

**P34007** Cuchara espagueti /  
spaghetti server /  
Cuillère à spaghetti /  
Spaghettilöffel

Nylon



REF	L cm	U
P340.070	29	12

**P34008** Tenedor /  
Meat fork /  
Fourchette /  
Fleischgabel

Nylon



REF	L cm	U
P340.080	29,5	12

**P34009** Pinza /  
Tong /  
Pince /  
Zange

Nylon



REF	L cm	U
P340.090	30,5	12

**P33601** Cacillo / ladle / Louche / Schöpflöffel

-40°C +210°C

Inox + Nylon  
St/Steel + Nylon  
Rostfreier Stahl + Nylon

REF	L cm	Lts	U
P33.601	32	0,08	12

**P33602** Espumadera / skimmer / Écumeiro / Schaumlöffel

-40°C +210°C

Inox + Nylon  
St/Steel + Nylon  
Rostfreier Stahl + Nylon

REF	L cm	Ø cm	U
P33.602	35	11,5	12

**P33603** Cuchara de servicio / serving spoon / Cuillère de service / Servierlöffel

-40°C +210°C

Inox + Nylon  
St/Steel + Nylon  
Rostfreier Stahl + Nylon

REF	L cm	U
P33.603	34,5	12

**P33604** Espátula / turner / Spatule / Pfannenwender

-40°C +210°C

Inox + Nylon  
St/Steel + Nylon  
Rostfreier Stahl + Nylon

REF	L cm	U
P33.604	35,5	12

**P33605** Batidor / whisk / Fouet / Rührbesen

-40°C +210°C

Inox + Nylon  
St/Steel + Nylon  
Rostfreier Stahl + Nylon

REF	L cm	U
P33.605	32	12

**P33607** Cuchara espagueti / spaghetti server / Cuillère à spaghetti / Spaghettilöffel

-40°C +210°C

Inox + Nylon  
St/Steel + Nylon  
Rostfreier Stahl + Nylon

REF	L cm	U
P33.607	34,5	12



**P33608** Espátula pastelera / baker spatula /  
Palette / Kuchenheber

-40°C +210°C

Inox + Nylon  
St/Steel + Nylon  
Rostfreier Stahl + Nylon

REF	L cm	U
P33.608	32,5	12

**P33610** Espátula wok / Wok spatula /  
Spatule wok / Wokschaufel

-40°C +210°C

Inox + Nylon  
St/Steel + Nylon  
Rostfreier Stahl + Nylon

REF	L cm	U
P33.610	35	12

**P33612** Pincel de silicona / Silicone brush /  
Pinceau silicone / Silikonpinsel

-40°C +210°C

Inox + Nylon  
St/Steel + Nylon  
Rostfreier Stahl + Nylon

REF	L cm	U
P33.612	29,5	12

**P33614** Pinza / Tong / Pince / Zange

-40°C +210°C

Inox + Nylon  
St/Steel + Nylon  
Rostfreier Stahl + Nylon

REF	L cm	U
P33.614	34,5	12

**P33620** Recipiente utensilios / Utensil holder / Porte ustensiles / Behälter für Küchenhelfer

REF	Ø cm	H cm	U
P33.620	13,5	19,0	12

Utensilios no incluidos  
Utensils not included  
Ustensiles non inclus  
Küchenhelfer nicht inklusive

## UTENSILIOS DE COCINA / KITCHEN UTENSILS / USTENSILES DE CUISINE / KÜCHENUTENSILIEN

**P32902** Abridor de botellas y latas / Bottle and can opener / Ouvre bouteilles et boîtes / Flaschen- und Dosenöffner



REF	Lts	U
P32.902	17	12

**P32905** Descorazonador manzanas / Apple corer / Vide-pommes / Apfelenkerner



REF	Lts	U
P32.905	20	12

**P32906** Pala para quesos / Cheese slicer / Couteau à fromage / Käsehobel



REF	Lts	U
P32.906	21,5	12

**P32908** Pelador patatas / Potato peeler / Eplucheur / Sparschäler



REF	Lts	U
P32.908	19,5	12

**P32909** Pelador universal / Universal peeler / Eplucheur universel / Universalschäler



REF	Lts	U
P32.909	17	12

**P32911** Prensa ajos / Garlic press / Press-ail / Knoblauchpresse



REF	Lts	U
P32.911	18,5	12

**P32912** Rallador / Grater / Râpe / Reibe



REF	L cm	U
P32.912	25	12

ACCESORIOS SILICONA / SILICONE ACCESSORIES / ACCESSOIRES SILICONE / SILIKONACCESSORIES

**P37318**

Colador extensible silicona /  
Silicone colander collapsible /  
Passoire silicone pliant /  
Faltbarer Silikonseih



REF	Ø cm	H cm	U
P37.318	18	11,0	1

**P2355**

Co-cotte silicona /  
Co-cotte silicone /  
Co-cotte silicone /  
Co-cotte Silikon



Microondas /  
Micro-wave /  
Microondes /  
Mikrowelle

Cocina al vapor /  
Steamer /  
Cuit-vapeur /  
Dampfgarer

REF	mm	H mm	U
P23.550	230 x 100	53,0	1
P23.551	265 x 115	85,0	1
P23.552	335 x 145	100,0	1

BATERIA COCINA FOODIES /  
FOODIES COOKWARE /  
BATTERIE CUISINE FOODIES

VER PRODUCTOS EN / SEE PRODUCTS ON / VOIR PRODUITS EN / SIEHE PRODUKTE IN



VER PRODUCTOS EN / SEE PRODUCTS ON / VOIR PRODUITS EN / SIEHE PRODUKTE IN



P. 114 PUJADAS



P. 123 PUJADAS



P. 121 PUJADAS



P. 125 PUJADAS



P. 254 PUJADAS



P. 268 PUJADAS



P. 106 VOLLRATH



P. 110 VOLLRATH



P. 117 VOLLRATH



P. 305 PUJADAS



P. 165 VOLLRATH



P. 173 VOLLRATH



P. 134 VOLLRATH



P. 136-141 VOLLRATH



P. 177 VOLLRATH



P. 146 VOLLRATH



P. 338 PUJADAS



P. 349 PUJADAS



P. 357 PUJADAS



P. 102 VOLLRATH









# TRANSPORTE Y ALMACENAMIENTO / TRANSPORT AND STORAGE / TRANSPORT ET STOCKAGE / TRANSPORT UND LAGERUNG

## 3.1 CUBETAS GASTRONORM / GASTRONORM CONTAINERS / BACS GASTRONORME / GASTRONORM BEHÄLTER 156

INOX 18/10 / 18/10 ST/STEEL / INOX 18/10 / EDELSTAHL 18/10	162
CUBETAS GN SP3 / SP3 GN PANS / BACS GN SP3 / GASTRONORM BEHÄLTER SP3 /	165
COMPLEMENTOS GASTRONORM / GASTRONORM ACCESSORIES / ACCESSOIRES GASTRONORME / GASTRONORM ASSESSOIRES	169
CON FONDO DIFUSOR / WITH SANDWICH BOTTOM / AVEC FOND THERMO-DIFFUSEUR / MIT SANDWICHBODEN	171
POLICARBONATO / POLYCARBONATE / POLYCARBONATE / POLYCARBONAT	172
SIN BISFENOL-A / BISPHENOL-A FREE / SANS BISPHÉNOL-A / OHNE BISFENOL-A	174
POLIPROPILENO / POLYPROPYLENE / POLYPROPYLÈNE / POLYPROPYLEN	176

## 3.2 CESTAS PARA VAJILLA / DISHWASHER RACKS / CASIERS À VAISSELLE / SPÜLMASCHINENKÖRBE 180

CESTAS BASE Y SUPLEMENTOS / RACKS AND EXTENDERS / PANIERS BASE ET RÉHAUSSE / BASISKÖRBE UND ERWEITERUNGEN	184
COMPLEMENTOS / COMPLEMENTS / COMPLÉMENTS/ ZUBEHÖR	191
CESTAS MEDIO TAMAÑO / HALF-SIZE RACKS / CASIERS DEMI-TAILLE / SPÜLKÖRBE IN HALBGRÖBE	192
CESTAS PARA PLATOS / PLATE RACKS / CASIERS ASSIETTES / TELLERSPÜLKÖRBE	194
CESTAS SIGNATURE / SIGNATURE RACKS / CASIERS SIGNATURE / SPÜLKÖRBE SIGNATURE	198

## 3.3 CARROS / TROLLEYS / CHARIOTS / SERVIERWAGEN 204

CARROS DE SERVICIO EN MADERA / WOODEN SERVING TROLLEYS / CHARIOTS DE SERVICE EN BOIS / SERVIERWAGEN AUS HOLZ	204
CARROS DE SERVICIO ALUMINIO / ALUMINIUM SERVING TROLLES / CHARIOTS DE SERVICE EN ALUMINIUM / SERVICEWAGEN AUS ALUMINIUM	208
CARROS DE SERVICIO ACERO INOXIDABLE / ST/STEEL SERVING TROLLEYS / CHARIOTS DE SERVICE EN ACIER INOXYDABLE / SERVIERWAGEN AUS EDELSTAHL	209
CARROS GUÍAS EN ACERO INOXIDABLE / ST/STEEL RAIL TROLLEYS / CHARIOTS À GLISSIÈRES EN ACIER INOXYDABLE / SERVIERWAGEN MIT EINSCHÜBEN AUS EDELSTAHL	212
CARROS ESPECIALES / SPECIAL TROLLEYS / CHARIOTS SPÉCIAUX / SPEZIALWAGEN	220

## 3.4 ESTANTERÍAS / SHELVING / ÉTAGÈRES / REGALE 224

COMPONENTES ESTANTERÍA / SHELVING PARTS / COMPONENTS ÉTAGÈRES / REGAL KOMponentEN	228
KIT ESTANTERÍA / SHELVING KITS / KITS ÉTAGÈRES / REGAL SETS	231

## CUBETAS GASTRONORM / GASTRONORM CONTAINERS / BACS GASTRONORME / GASTRONORM BEHÄLTER

ESPAÑOL

CONFORME A LA NORMA EN-631.2 PUJADAS OFRECE UNA DE LAS GAMAS DE CUBETAS GASTRONORM DE FABRICACIÓN PROPIA MÁS AMPLIA DEL MERCADO

ENGLISH

ACCORDING TO EN-631.2 PUJADAS OFFERS ONE OF THE MOST SPECIALIZED RANGES, IN-HOUSE MANUFACTURING, OF GASTRONORM CONTAINERS IN THE MARKET

FRANÇAIS

SUIVANT LA NORME EN-631.2 PUJADAS PROPOSE UNE DES GAMMES DE BACS GASTRONORME DE PROPRE FABRICATION DES PLUS SPÉCIALISÉS DU MARCHÉ

DEUTSCH

ENTSPRECHEND DER NORM EN-631.2 BIETET PUJADAS AUS EIGENER HERSTELLUNG EINE DER BREITESTEN PRODUKTPALLETTE IM HANDEL AN.

**ACERO INOXIDABLE /  
ST/STEEL /  
ACIER INOXYDABLE /  
ROSTFREIER STAHL**  
18/10



BORDES REFORZADOS /  
REINFORCED EDGES /  
BORDS RENFORCÉS /  
VERSTÄRKTÉ RÄNDER

GEOMETRÍA ADAPTADA: + LIMPIEZA + CAPACIDAD /  
RADIOUS SPECIALLY DESIGNED FOR: + CAPACITY + CLEANING /  
GÉOMÉTRIE ADAPTÉE: + PROPRETÉ + CAPACITÉ /  
RADIUS SPEZIELL DESIGNT: + KAPAZITÄT + REINIGUNG

**SUPER PAN 3**  
**ACERO INOXIDABLE /  
ST/STEEL /  
ACIER INOXYDABLE /  
ROSTFREIER STAHL**  
18/10



ESQUINAS REFORZADAS CON FORMA DE PICO /  
REINFORCED SPOUTED-SHAPE CORNERS /  
COINS RENFORCÉS EN FORME DE BEC /  
VERSTÄRKTÉ ECKEN IN AUSGIESSFORM



RADIO ESTRECHO /  
NARROW RADIUS /  
RAYON ÉTROIT /  
ENGEN RADIUS

APILADO ANTIATASCOS /  
ANTI-JAM STACKING LUGS /  
POINTES D'EMPLIAGE ANTI-COINCÈMENT /  
VERKEILUNG SICHERE STAPELNASEN

BORDES APLANADOS DE LA FUENTE /  
FLATTENED PAN EDGES /  
BORDS DE BACS GN APLATIS /  
ABGEFLACHTÉ WANNENKANTEN VERHINDERN

**POLICARBONATO /  
POLICARBONATO /  
POLYCARBONATE /  
POLYCARBONAT**

- 40 °C  
 + 130 °C

BORDES REFORZADOS /  
REINFORCED RIMS /  
BORDS RENFORCÉS /  
VERSTÄRKTÉ RÄNDER

MARCAJE MODELO CUBETA /  
CONTAINER MODEL /  
TYPE DE BAC /  
MODELMARKIERUNG AM BEHÄLTER

TEXTURA PARA EVITAR RALLADAS /  
TEXTURING CORNERS TO AVOID SCRATCHING /  
CÔTÉS GRANITÉS POUR ÉVITER RAYURES /  
STRUKTUR UM VERKRATZUNGEN ZU VERHINDERN



MAYOR GROSOR /  
THICKER /  
PLUS ÉPAIS /  
DICKER

GRADUACIÓN EXTERNA DE CAPACIDAD /  
GRADUATIONS MARKED EXTERNALLY /  
ÉCHELLE DE GRADUATIONS À L'EXTÉRIEUR /  
EXTERNE SKALIERUNG DES FASSUNGSVERMÖGEN

CARACTERÍSTICAS MARCADAS EN EL FONDO /  
MAIN FEATURES MARKED ON THE BASE /  
CARACTERISTIQUES MARQUÉS AU FOND /  
EIGENSCHAFTEN IM BODEN MARKIERT

**SIN BISFENOL-A /  
BISPHENOL-A FREE /  
SANS BISPHÉNOL-A /  
OHNE BISFENOL-A**

- 40 °C  
 + 90 °C



**POLIPROPILENO /  
POLYPROPYLENE /  
POLYPROPYLENE /  
POLYPROPYLEN**

- 40 °C  
 + 110 °C

HERMÉTICO CON TAPA POLINORM /  
HERMETIC WITH POLINORM LID /  
HERMETIQUE AVEC COUVERCLE POLINORM /  
HERMETISCH MIT POLINORM DECKEL

BORDES REFORZADOS /  
REINFORCED RIMS /  
BORDS RENFORCÉS /  
VERSTÄRKTÉ RÄNDER

MARCAJE MODELO CUBETA /  
CONTAINER MODEL /  
TYPE DE BAC /  
MODELMARKIERUNG AM BEHÄLTER

TEXTURA PARA EVITAR RALLADAS /  
TEXTURING CORNERS TO AVOID SCRATCHING /  
CÔTÉS GRANITÉS POUR ÉVITER RAYURES /  
STRUKTUR UM KRATZER ZU VERHINDERN



MAYOR GROSOR /  
THICKER /  
PLUS ÉPAIS /  
DICKER

GRADUACIÓN EXTERNA DE CAPACIDAD /  
GRADUATIONS MARKED EXTERNALLY /  
ÉCHELLE DE GRADUATIONS À L'EXTÉRIEUR /  
EXTERNE SKALIERUNG DES FASSUNGSVERMÖGEN

CARACTERÍSTICAS MARCADAS EN EL FONDO /  
MAIN FEATURES MARKED ON THE BASE /  
CARACTERISTIQUES MARQUÉS AU FOND /  
EIGENSCHAFTEN IM BODEN MARKIERT



**COCCIÓN /  
COOKING /  
CUISSON /  
KOCHEN**

**PATENTED EXCLUSIVE**



GN CON FONDO DIFUSOR /  
GN PAN WITH SANDWICH BASE /  
BAC GN AVEC FOND THERMO-DIFFUSEUR /  
GN BACKFORM MIT SANDWICHBODEN



GN ALUMINIO ANTIADHERENTE /  
NON-STICK ALUMINIUM GN PAN /  
BAC GN ANTI-ADHÉSIF EN ALUMINIUM /  
GN BACKFORM ALUMINIUM ANTIHAFT



BANDEJAS GN ESPECIAL HORNO /  
SPECIAL OVEN GN PANS /  
PLAQUES SPÉCIALES GN POUR FOUR /  
SPEZIELLE GN OFENFORMEN

**TRANSPORTE /  
TRANSPORT /  
TRANSPORT /  
TRANSPORT**



GN INOX + TAPA INOX HERMÉTICA /  
ST/STEEL GN + ST/STEEL HERMETIC LID /  
BAC GN INOX + COUVERCLE ÉTANCHE INOX /  
GN EDELSTAHL + EDELSTAHLDECKEL HERMETISCH

TEMP. 120°C

HERMÉTICO / HERMETIC  
ÉTANCHE / HERMETISCH



POLICARBONATO O CUBETA SIN BISFENOL-A + TAPA POLINORM® /  
POLYCARBONATE OR BPA FREE + POLINORM® LID /  
POLYCARBONATE OÙ SANS BPA + COUVERCLE POLINORM® /  
POLYCARBONAT ODER OHNE BISFENOL-A BEHÄLTER + POLINORM®DECKEL

TEMP. 100°C



GN POLIPROPILENO + TAPA POLINORM® /  
POLYPROPYLENE + POLINORM® LID /  
GN POLYPROPYLENE + COUVERCLE POLINORM® /  
GN POLIPROPYLEN + POLINORM® DECKEL

TEMP. 90°C

HERMÉTICO / HERMETIC  
ÉTANCHE / HERMETISCH

**ALMACENAMIENTO /  
STORAGE /  
STOCKAGE /  
LAGERUNG**



GN POLICARBONATO + TAPA POLICARBONATO /  
POLYCARBONATE GN + POLYCARBONATE LID /  
GN POLYCARBONATE + COUVERCLE POLYCARBONATE /  
GN POLYCARBONAT + POLYCARBONAT DECKEL



GN POLICARBONATO + TAPA POLINORM® /  
POLYCARBONATE GN + POLINORM® LID /  
POLYCARBONATE + COUVERCLE POLINORM® /  
GN POLYCARBONAT + POLINORM® DECKEL



GN POLIPROPILENO + TAPA POLINORM® /  
POLYPROPYLENE + POLINORM® LID /  
GN POLYPROPYLENE + COUVERCLE POLINORM® /  
GN POLYPROPYLEN + POLINORM® DECKEL

**PRESENTACIÓN /  
DISPLAY /  
PRÉSENTATION /  
PRÄSENTATION**



GN POLICARBONATO + TAPA POLICARBONATO /  
POLYCARBONATE GN + POLYCARBONATE LID /  
GN POLYCARBONATE + COUVERCLE POLYCARBONATE /  
POLYCARBONAT GN + POLYCARBONAT DECKEL



GN INOX CON FONDO DIFUSOR + TAPA POLICARBONATO /  
ST/STEEL GN WITH SANDWICH BASE + POLYCARBONATE LID /  
GN INOX AVEC FOND THERMO-DIFFUSEUR + POLYCARBONATE /  
EDELSTAHL GN MIT SANDWICHBODEN + POLYCARBONAT DECKEL



GN POLICARBONATO + TAPA POLICARBONATO /  
POLYCARBONATE GN + POLYCARBONATE LID /  
GN POLYCARBONATE + COUVERCLE POLYCARBONATE /  
POLYCARBONAT GN + POLYCARBONAT DECKEL



GN MELAMINA /  
MELAMINE GN /  
GN MÉLAMINE /  
MELAMIN GN

VER PÁGINA 299 / 301  
REFER TO PAGE 299 / 301  
VOIR PAGE 299 / 301  
SIEHE SEITE 299 / 301

SELECCIÓN CUBETAS GASTRONORM / GASTRONORM CONTAINERS SELECTION /  
SELECTION BACS GASTRONORME / AUSWAHLÜBERSICHT GASTRONORM BEHÄLTERINOX 18/10 /  
18/10 ST/STEEL /  
INOX 18/10 /  
EDELSTAHL 18/10

SP3

INOX 18/10 /  
18/10 ST/STEEL /  
INOX 18/10 /  
EDELSTAHL 18/10INOX 18/10 FONDO DIFUSOR /  
18/10 ST/STEEL SANDWICH BOTTOM /  
INOX 18/10 FOND THERMO-DIFFUSEUR /  
EDELSTAHL 18/10 SANDWICHBODENALUMINIO ANTIADHERENTE /  
NON-STICK ALUMINIUM /  
ALUMINIUM ANTI-ADHÉSIF /  
ALUMINIUM ANTIHAFT

NSF



NSF



NSF

VER PÁGINA 54 / REFER TO PAGE 54 /  
VOIR PAGE 54 / SIEHE SEITE 54

PRESENTACIÓN / APPEARANCE / PRÉSENTATION / PRÄSENTATION	✓	✓	●	●
RESISTENCIA / ROBUSNESS / ROBUSTESSE / RESISTENZ	✓	✓	✓	●
ALMACENAMIENTO / STORAGE / STOCKAGE / LAGERUNG	✓	✓	●	✗
BAÑO-MARIA / BAIN MARIE / BAIN-MARIE / WASSERBAD	✓	✓	✓	●
TEMPERATURA MAX / TEMPERATURE MAX / TEMPÉRATURE MAX. / MAX. TEMPERATUR	✓	✓	✓	✓
HORNO / OVEN / FOUR / OFEN	✓	✓	✓	✓
MICROONDAS / MICRO-WAVE / MICRO-ONDES / MIKROWELLE	✗	✗	✗	✗
COCCIÓN / COOKING / CUISSON / KOCHEN	●	●	✓	✓
INDUCCIÓN / INDUCTION / INDUCTION / INDUKTION	✗	✗	✓	✗
TRANSPORTE EN CALIENTE / WARM TRANSPORTATION / TRANSPORT CHAUD / WARMER TRANSPORT	✓	✓	✓	●
TAPA POLINORM / POLINORM LID / COUVERCLE POLINORM / POLINORM DECKEL	✓	✓	✓	✗
ANTIATASCOS / ANTI-JAM / ANTI-COINCEMENT / STAPELNASEN /	✗	✓	✗	✗

✓ RECOMENDADO / RECOMMENDED /  
RECOMMANDÉ / EMPFOHLEN

● ACCEPTABLE / SUITABLE /  
ACCEPTABLE / ANNEHMBAR

✗ NO RECOMENDADO / NOT RECOMMENDED /  
PAS RECOMMANDÉ / NICHT EMPFOHLEN

SELECCIÓN CUBETAS GASTRONORM / GASTRONORM CONTAINERS SELECTION / SELECTION BACS GASTRONORME / AUSWAHLÜBERSICHT GASTRONORM BEHÄLTER

POLICARBONATO /  
POLYCARBONATE /  
POLYCARBONAT /  
POLYCARBONAT

SIN BISFENOL-A /  
BISPHENOL-A FREE /  
SANS BISPHÉNOL-A /  
OHNE BISFENOL-A

POLIPROPILENO /  
POLYPROPYLENE /  
POLYPROPYLENE /  
POLYPROPYLEN

MELAMINA\* /  
MELAMINE\* /  
MÉLAMINE\* /  
MELAMIN\*



VER PÁGINA 299-301 / REFER TO PAGE 299-301 / VOIR PAGE 299-301 / SIEHE SEITE 299-301

●	●	●	✓
✓	✓	●	✓
✓	✓	●	●
●	●	✗	●
130 °C	90 °C	110 °C	70 °C
130 °C	✗	✗	✗
✓	✓	✓	✗
✗	✗	✗	✗
✗	✗	✗	✗
130 °C	80 °C	✗	70 °C
✓	✓	✓	✗
✗	✗	✗	✗

\* AMBIENTE HÚMEDO / HUMID ENVIRONMENT / ENVIRONNEMENT HUMIDE / FEUCHTE UMGEBUNG

**MEDIDAS Y COMBINACIONES / SIZES AND COMBINATIONS /  
MESURES ET COMBINAISONS / MASSE UND KOMBINATIONEN**
**COMBINACIONES / COMBINATIONS / COMBINAISONS / KOMBINATIONEN**

**MEDIDAS DE ENCASTE / FITTING MEASURES / MESURES D'EMBOÎTEMENT / MASSE DER EINSETZLÖCHER**

Modelo	"A"	"B"
2/1	630	510
1/1	510	305
2/3	333	305
1/2	305	245
1/3	305	155
1/4	245	142
1/6	156	142
1/9	156	88

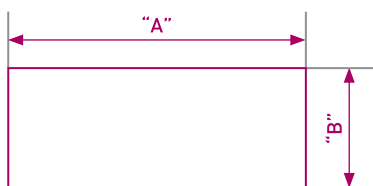



**TAPA GN POLINORM® /  
GN POLYNORM® LID /  
GN COUVERCLE POLYNORM® /  
GN POLYNORM® DECKEL**

**PATENTED EXCLUSIVE**



**DISPONIBLE EN CINCO COLORES / AVAILABLE IN FIVE COLOURS /  
DISPONIBLE EN CINQ COULEURS / IN FÜNF FARBEN VERFÜGBAR**



**ADAPTABLES A / ADJUSTABLES TO / ADAPTABLE À / PASSEND ZU**



GN INOXIDABLE /  
ST/STEEL GN CONTAINERS /  
GN INOXIDABLE /  
GN EDELSTAHL BEHÄLTER



GN POLICARBONATO /  
POLYCARBONATE GN CONTAINERS /  
GN POLYCARBONATE /  
GN POLYCARBONAT BEHÄLTER



GN SIN BISFENOL-A /  
BPA FREE CONTAINER /  
SANS BISPHÉNOL-A /  
GN BEHÄLTER OHNE BISFENOL-A



GN POLIPROPILENO /  
POLYPROPYLENE GN CONTAINERS /  
GN POLYPROPYLENE /  
POLYPROPYLEN GN BEHÄLTER

**ENCAJE EXTERIOR /  
OUTER SIDE FITTING /  
EMBOÏTEMENT EXTÉRIEUR /  
ÄUSSERE EINSETZFASSUNG**

**ENCAJE INTERIOR /  
INNER SIDE FITTING /  
EMBOÏTEMENT INTÉRIEUR /  
INNERE EINSETZFASSUNG**

TAPA POLINORM /  
POLINORM LID /  
COUVERCLE POLINORM /  
POLINORM DECKEL

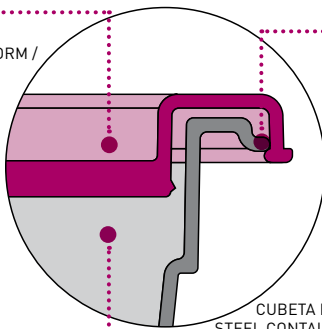

CLIPS PARA CIERRE  
CUBETA INOX Y PC /  
FLAPS TO FIT WITH  
GN INOX AND PC /  
RAINURES POUR  
CLIPSER BACS GN  
INOX ET PC /  
VERSCHLUSSKLEMME  
FÜR EDELSTAHL UND  
PC BEHÄLTER

CUBETA INOX / POLICARBONATO /  
STEEL CONTAINER / POLYCARBONATE /  
BAC INOX / POLYCARBONATE /  
EDELSTAHL / POLYCARBONAT BEHÄLTER

TAPA POLINORM /  
POLINORM LID /  
COUVERCLE POLINORM /  
POLINORM DECKEL

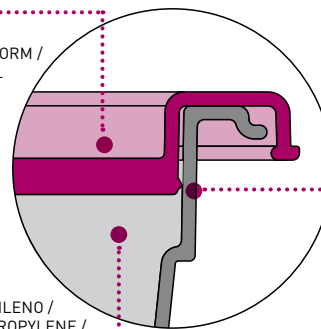

CIERRE HERMÉTICO  
PARA CUBETAS DE PP /  
HERMETICAL FOR PP  
CONTAINERS /  
HERMETIQUE SUR  
BACS PP /  
HERMETISCHER  
VERSCHLUSS  
FÜR BEHÄLTER AUS PP

CUBETA POLIPROPILENO /  
CONTAINER POLYPROPYLENE /  
BAC POLYPROPYLENE /  
POLYPROPYLEN BEHÄLTER

**GASTRONORM INOX 18/10 / 18/10 ST/STEEL GASTRONORM /  
GASTRONORME INOX 18/10 / GASTRONORM EDELSTAHL 18/10**
**2/1** 650 x 530 mm

18/10

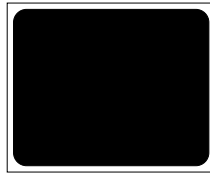

REF	H mm	Lts	U
P210.201	20	6,20	1
P210.401	40	11,50	1
P210.651	65	18,80	1
P211.001	100	28,90	1
P211.501	150	43,10	1
P212.001	200	52,00	1

**1/1** 530 x 325 mm

18/10



REF	H mm	Lts	U
P110.201	20	2,80	1
P110.401	40	5,10	1
P110.551	55	7,00	1
P110.651	65	8,30	1
P111.001	100	14,20	1
P111.501	150	20,20	1
P112.001	200	26,00	1

**2/3** 353 x 325 mm

18/10



REF	H mm	Lts	U
P230.201	20	1,70	1
P230.401	40	3,10	1
P230.651	65	5,60	1
P231.001	100	8,80	1
P231.501	150	13,20	1
P232.001	200	18,30	1

**1/2** 325 x 265 mm

18/10

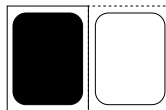

REF	H mm	Lts	U
P120.201	20	1,20	1
P120.401	40	2,20	1
P120.651	65	4,10	1
P121.001	100	6,10	1
P121.501	150	9,10	1
P122.001	200	12,00	1

**2/4** 530 x 165 mm

18/10



REF	H mm	Lts	U
P240.401	40	1,80	1
P240.651	65	4,00	1
P241.001	100	6,00	1
P241.501	150	10,00	1

**1/3** 325 x 176 mm

18/10

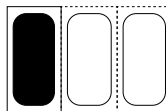

REF	H mm	Lts	U
P130.201	20	0,80	1
P130.401*	40	1,50	1
P130.651	65	2,50	1
P131.001	100	3,80	1
P131.501	150	5,60	6
P132.001	200	7,30	6

**IDEA!**

- \* Cubeta GN especial para vitrinas mostrador snack.
- \* Special GN container for snack showcases.
- \* Bac GN spécial pour vitrines snack.
- \* Spezial GN Behälter für Snackglasvitrinen

GASTRONORM INOX 18/10 / 18/10 ST/STEEL GASTRONORM / GASTRONORME INOX 18/10 / GASTRONORM EDELSTAHL 18/10

**1/4** 265 x 162 mm

18/10



REF	H mm	Lts	U
P140.201	20	0,50	1
P140.651	65	1,70	1
P141.001	100	2,80	1
P141.501	150	4,10	6
P142.001	200	5,00	6

**1/6** 176 x 162 mm

18/10

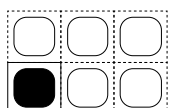

REF	H mm	Lts	U
P160.651	65	1,00	1
P161.001	100	1,60	1
P161.501	150	2,20	6
P162.001	200	2,90	6

**1/9** 176 x 108 mm

18/10

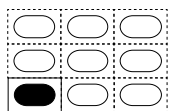

REF	H mm	Lts	U
P190.651	65	0,60	1
P191.001	100	0,80	1

Fondos perforados para cubetas / Perforated bottoms for containers / Egouttoirs pour bacs / Gelochte Böden für Behälter



Aptos para cubetas SP3 hasta 100 mm de profundidad  
Adjustable to SP3 upto 100 mm depth  
Adaptables à bacs SP3 jusqu'à 100 mm profondeur  
Geeignet für Behälter SP3 bis 100 mm tief

REF	Mod	U
P215.000	2/1	1
P115.000	1/1	1
P235.000	2/3	1
P125.000	1/2	1
P135.000	1/3	1
P145.000	1/4	1

Perfiles divisorios / Adaptable bars / Barrettes de composition / Profilstege



REF	Mod	L cm	U
P111.111	1/1	53	1
P122.222	1/2	32,5	1

Para realizar cualquier composición con las cubetas gastronorm.  
To arrange any composition with gastronorm containers.  
Pour réaliser toute composition avec les bacs gastronorm.  
Für die Realisierung aller Kombinationen mit den GN Behälter.

Asas móviles / Falling handles / Anses tombantes / Fallgriffe

Añadir AM a la referencia de la cubeta elegida  
Add AM to the GN container reference  
Ajouter AM à la référence du bac GN  
Fügen Sie die AM zu den ausgewählten Art.Nr. der GN

Apta para todas las medidas de cubetas  
Suitable for all GN sizes  
Apte sur toutes les dimensions GN  
Einsetzbar an alle Größen der Behälter



U
1

Precio cubeta / Container price /  
Prix bac / Behälterpreis

Asas fijas / Fixed handles / Anses fixes / Feste Griffe

Añadir AF a la referencia de la cubeta elegida  
Add AF to the GN container reference  
Ajouter AF à la référence du bac GN  
Fügen Sie die AF zu den ausgewählten Art.Nr. der GN

Sólo para cubetas 1/2, 1/3, 1/4 y 1/6  
Only for containers 1/2, 1/3, 1/4 and 1/6  
Seulement pour bacs 1/2, 1/3, 1/4 et 1/6  
Nur für Behälter 1/2, 1/3, 1/4 und 1/6



U
1

Precio cubeta / Container price /  
Prix bac / Behälterpreis

**GASTRONORM INOX 18/10 / 18/10 ST/STEEL GASTRONORM /  
GASTRONORME INOX 18/10 / GASTRONORM EDELSTAHL 18/10**
**2/1** 650 x 530 mm

18/10

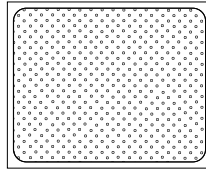

REF	H mm	U
P210.202	20*	1
P210.402	40*	1
P210.652	65*	1
P211.002	100**	1
P211.502	150**	1
P212.002	200**	1

**1/1** 530 x 325 mm

18/10

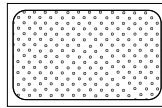

REF	H mm	U
P110.202	20*	1
P110.402	40*	1
P110.552	55*	1
P110.652	65*	1
P111.002	100**	1
P111.502	150**	1
P112.002	200**	1

**2/3** 353 x 325 mm

18/10

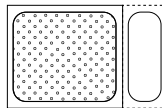

REF	H mm	U
P230.202	20*	1
P230.402	40*	1
P230.652	65*	1
P231.002	100**	1
P231.502	150**	1
P232.002	200**	1

**1/2** 325 x 265 mm

18/10

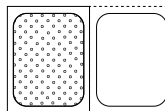

REF	H mm	U
P120.652	65*	1
P121.002	100**	1
P121.502	150**	1
P122.002	200**	1

**1/3** 325 x 176 mm

18/10

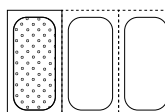

REF	H mm	U
P130.202	20*	1
P130.402	40*	1
P130.652	65*	1
P131.002	100**	1
P131.502	150**	1
P132.002	200**	1

\* Fondo perforado  
\* Perforated bottom  
\* Fond perforé  
\* Gelochter Boden

\*\* Fondo y laterales perforados  
\*\* Perforated bottom and sides  
\*\* Fonds et latéraux perforés  
\*\* Boden und Seiten gelocht



# SP3 SUPER PAN 3

ESQUINAS REFORZADAS CON FORMA DE PICO /  
REINFORCED SPOUTED-SHAPE CORNERS /  
COINS RENFORCÉS EN FORME DE BEC /  
VERSTÄRKT ECKEN IN AUSGIESSFORM

RADIO ESTRECHO /  
NARROW RADIUS /  
RAYON ÉTROIT /  
ENGEN RADIUS

APILADO ANTIATASCOS /  
ANTI-JAM STACKING LUGS /  
POINTES D'EMPILAGE ANTI-COINCEMENT /  
VERKEILUNG SICHERE STAPELNASEN

BORDES APLANADOS /  
FLATTENED PAN EDGES /  
BORDS DE BACS GN APLATIS /  
ABGEFLACHTE WANNENKANTEN VERHINDERN



**1/1** 530 x 325 mm

18/10



REF	H mm	Lts	U
90002	20	-	6
90012	40	5,4	6
90052	55	7,3	6
90022	65	8,5	6
90042	100	13,4	6
90062	150	19,9	6
90082	200	26,1	6

**2/3** 353 x 325 mm

18/10

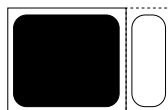

REF	H mm	Lts	U
90102	20	-	6
90112	40	3,4	6
90122	65	5,4	6
90142	100	8,0	6
90162	150	11,9	6
90182	200	15,5	6

**1/2** 325 x 265 mm

18/10

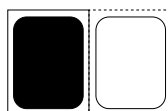

REF	H mm	Lts	U
90202	20	-	6
90212	40	2,4	6
90252	55	3,3	6
90222	65	3,8	6
90242	100	6,0	6
90262	150	8,9	6
90282	200	11,6	6

GASTRONORM INOX 18/10 / 18/10 ST/STEEL GASTRONORM /  
GASTRONORME INOX 18/10 / GASTRONORM EDELSTAHL 18/10

SP3

**2/4** 530 x 165 mm

18/10

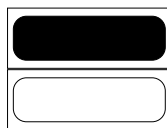
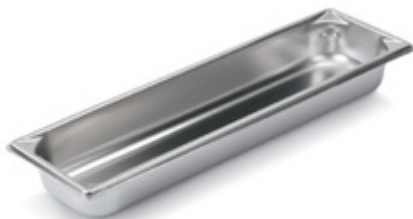

REF	H mm	Lts	U
90502	20	-	6
90512	30	2,4	6
90552	55	3,1	6
90522	65	3,7	6
90542	100	5,7	3
90562	150	8,2	3

**1/3** 325 x 176 mm

18/10

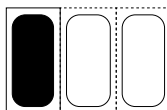

REF	H mm	Lts	U
90302	20	-	6
90312	40	1,6	6
90352	55	2,0	6
90322	65	2,4	6
90342	100	3,7	6
90362	150	5,5	6
90382	200	7,1	3

**1/4** 265 x 162 mm

18/10



REF	H mm	Lts	U
90402	20	-	6
90412	40	1,1	6
90452	55	1,5	6
90422	65	1,7	6
90442	100	2,6	6
90462	150	3,8	6
90482	200	4,8	3

**1/6** 176 x 162 mm

18/10

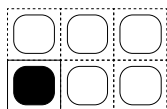

REF	H mm	Lts	U
90622	65	1,1	6
90642	100	1,6	6
90662	150	2,3	6
90682	200	3,0	3

**1/9** 176 x 108 mm

18/10

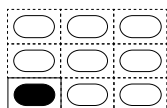

REF	H mm	Lts	U
90922	65	0,60	6
90942	100	0,80	6

TAPAS Y FONDOS PERFORADOS\*, SE PUEDEN UTILIZAR LOS DE LA GAMA DE CUBETAS INOX.  
\*Fondos hasta 100 mm de profundidad.

LIDS AND FALSE BOTTOMS\*, USE THE SAME AS OUR STANDARD RANGE  
\*False bottoms just to 100 mm depth.

COUVERCLES AND EGOUTTOIRS\*, UTILIZER LES MEMES QUE LA GAMME STANDARD  
\*Egouttoirs jusqu'à 100 mm profondeur.

GELÖCHTE DECKEL UND BÖDEN\*, ES KÖNNEN DIE AUS DER EDELSTAHLBEHÄLTER-REIHE VERWENDET WERDEN  
\*Tiefen bis 100 mm



# SHAPED PANS



VER PRODUCTOS EN / SEE PRODUCTS ON / VOIR PRODUITS EN / SIEHE PRODUKTE IN P. 17-19

# CONTEMPORARY PANS



VER PRODUCTOS EN / SEE PRODUCTS ON / VOIR PRODUITS EN / SIEHE PRODUKTE IN P. 28-29

**GASTRONORM INOX 18/10 / 18/10 ST/STEEL GASTRONORM /  
GASTRONORME INOX 18/10 / GASTRONORM EDELSTAHL 18/10**
**Tapa Polinorm® / Polinorm® Lid / Couvercle Polinorm® / Polinorm® Deckel**
**PATENTED / EXCLUSIVE**

REF	Mod	U
P110.0 + COLOR	1/1	30
P120.0 + COLOR	1/2	60
P130.0 + COLOR	1/3	30
P140.0 + COLOR	1/4	30
P160.0 + COLOR	1/6	60
P190.0 + COLOR	1/9	30

 Ref. color tapa /  
Ref. colour lid /  
Ref. couleur couvercle /  
Art.Nr. Deckelfarbe

 Cubetas GN inox, PC, sin Bisfenol-A y PP. No aptas para la gama SP3 /  
St/Steel, PC, Bisphenol-A FREE and PP GN containers. Not for SP3 range /  
Bacs GN inox, PC, sans Bisphénol-A et PP. Pas pour la gamme SP3 /  
GN Behälter rostfrei, PC, ohne Bisphenol-A und PP. Edelstahlbehälter GN, PC,  
ohne Bisphenol-A und PP. Nicht geeignet für SP3

**Tapa / Lid / Couvercle / Deckel**

18/10



REF	Mod	U
P110.000	1/1	1
P230.000	2/3	1
P120.000	1/2	1
P130.000	1/3	1
P140.000	1/4	1
P160.000	1/6	1
P190.000	1/9	1

**Tapa plana sin asa / Flat lid without handle / Couvercle plat sans anse / Flacher Deckel ohne Griff**

REF	Mod	U
P110.005	1/1	1
P120.005	1/2	1

**Tapa hermética / Hermetic lid / Couvercle étanche / Hermetischer Deckel**

18/10

 Detalle silicona  
Silicone joint  
Joint silicone  
Detail Silikon

REF	Mod	U
P110.004	1/1	1
P120.004	1/2	1
P130.004	1/3	1
P140.004	1/4	1
P160.004	1/6	1

**Tapa orificio asas / Lid with splits for handles / Couvercle avec encoche pour anses / Deckel mit Öffnung für Griffe**

18/10



REF	Mod	U
P110.001	1/1	1
P230.001	2/3	1
P120.001	1/2	1
P130.001	1/3	1
P140.001	1/4	1
P160.001	1/6	1

**Tapa orificio cacillo / Lid with split for ladle / Couvercle avec encoche pour louche / Deckel mit Öffnung für Löffel**

18/10



REF	Mod	U
P110.002	1/1	1
P120.002	1/2	1
P130.002	1/3	1
P140.002	1/4	1
P160.002	1/6	1



COMPLEMENTOS GASTRONORM / GASTRONORM ACCESSORIES / ACCESSOIRES GASTRONORME / GASTRONORM ASSESSOIRS

**19196 / 19184** Placa adaptadora angular / Angled Adaptor Plate /  
Plaque intermédiaire inclinée / Gewinkelte Adapterplatte



19184

REF	cm	TIPO / TYPE	U
19196	53 x 32.4 x 7.2	1 GN 1/1 (6°)	2
19184	53 x 32.4 x 5.4	2 GN 1/2 (8,2°)	1



19196



19184

Eleva las cubetas para mejorar la presentación de los alimentos /  
Elevates pans to enhance food presentation /  
Élévage des bacs pour améliorer la présentation des aliments /  
Erhöhte Pfannen zur Verbesserung der Lebensmittelpräsentation

**100002** Presentador 6 cubetas GN 1/6 inox / St/Steel stand 6 slots GN 1/6  
Support bacs pour 6 GN 1/6 inox / Edelstahl Ständer für 6 GN Behälter 1/6



REF	U
P100.002P	1

No incluye cubetas  
Containers not included  
Bacs non inclus  
Behälter nicht inklusive

**100004** Presentador cubetas GN / Stand for GN containers /  
Support pour bacs GN / Ständer für GN Behälter

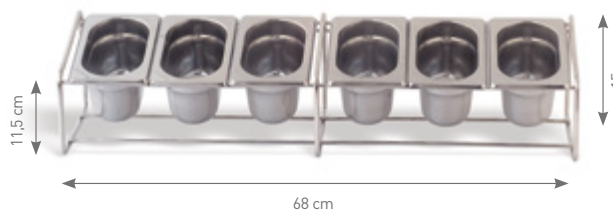

REF	U
P100.004P	1

Soporte solo / Only stand /  
Support seul / Nur Ständer

REF	CONJUNTO / SET / LOT / SET	U
P100.005P	6 - GN 1/9 65 mm	1
P100.006P	6 - GN 1/9 100 mm	1
P100.008P	4 - GN 1/6 100 mm	1

Permiten sostener / It can contain /  
Il peut contenir / Einsetzmöglichkeiten

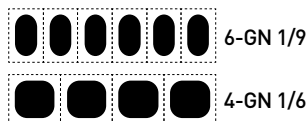

En profundidades 65 y 100 mm  
65 or 100 mm deep  
Profondeurs 65 ou 100 mm  
In Tiefen von 65 und 100 mm

Adaptable a cubetas GN policarbonato y polipropileno  
Adjustable to GN container in polycarbonate and polypropylene  
Adapté à bacs GN en polycarbonate et polypropylène  
Passend für GN Behälter aus Polycarbonat und Polypropylen

**100003** Soporte para tapas GN / Stand for GN lids /  
Support pour couvercles GN / Ständer für GN Deckel

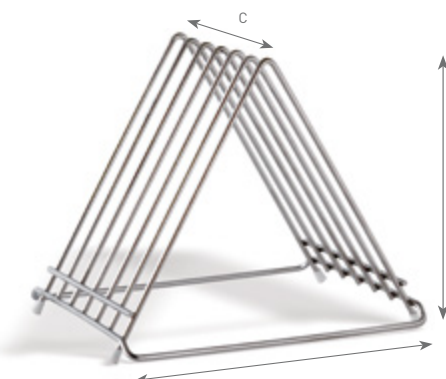

REF	A cm	B cm	C cm	U
P100.003P	27	31	27	1

Para 6 tapas  
For 6 lids  
Pour 6 couvercles  
Für 6 Deckel

Distancia entre varillas 2,5 cm  
Distance between wires 2,5 cm  
Distance entre fils 2,5 cm  
Abstand zwischen den Stäben 2,5 cm



Ideal para tablas de corte. Ver página 116-118  
Perfect for cutting boards. Refer to page 116-118  
Ideal pour planches à découper. Voir page 116-118  
Ideal für Schneidbretter. Siehe Seiten 116-118

**COMPLEMENTOS GASTRONORM / GASTRONORM ACCESSORIES /  
ACCESSOIRES GASTRONORME / GASTRONORM ASSESSOIRES**

+232,2°C

**PATENTED / EXCLUSIVE**

ESPAÑOL

FIJA LA TAPA, EL PAPEL DE ALUMINIO O EL PAPEL FILM, A LA CUBETA, PARA UN TRANSPORTE Y ALMACENAMIENTO SEGURO. APTA PARA LAVAVAJILLAS. FÁCIL DE USAR.

ENGLISH

ATTACH THE LID, ALUMINIUM FOIL OR CLING FILM TO THE TRAY FOR SECURE TRANSPORT OR STORAGE. DISHWASHER SAFE. EASY TO USE.

FRANÇAIS

FIXE LE COUVERCLE, LE PAPIER D'ALUMINIUM OU LE FILM ALIMENTAIRE AU BAC POUR TRANSPORT ET STOCKAGE DE FAÇON SÛRE. VA AU LAVE-VAISSELLE. FACILE À UTILISER.

DEUTSCH

BEFESTIGEN SIE DEN DECKEL, DIE ALU- ODER FRISCHHALTEFOLIE AM BEHÄLTER FÜR EINEN SICHEREN TRANSPORT UND EINE SICHERE LAGERUNG. SPÜLMASCHINGEEIGNET. EINFACHE BETRIEBUNG

Scan me



Click me

**N-0001B** Banda selladora silicona GN. Negra / GN Pan Band. Black /  
Bande à silicone GN. Noir / GN-Silikon-Band. Schwarz /

+232,2°C

**PATENTED / EXCLUSIVE**

REF	TIPO / TYPE	U
N-0001B	1/1	24
N-0002B	1/2	24
N-0003B	1/3	24
N-0006B	1/6	24

**N-0001G** Banda selladora silicona GN. Gris / GN Pan Band. Grey /  
Bande à silicone GN. Gris / GN-Silikon-Band. Grau /

+232,2°C

**PATENTED / EXCLUSIVE**



REF	TIPO / TYPE	U
N-0001G	1/1	24
N-0002G	1/2	24
N-0003G	1/3	24
N-0006G	1/6	24

VER PRODUCTOS EN / SEE PRODUCTS ON / VOIR PRODUITS EN PAGE / SIEHE PRODUKTE IN

**1/1**
**Bandeja GN antiadherente / Non-stick GN pan tray / Plaque GN anti-adhésive / Antihaft Tablett GN**

ALUMINIO / ALUMINIUM

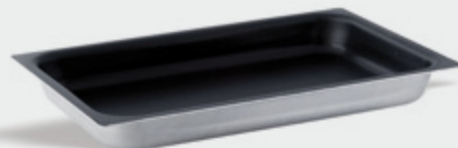
P. 54



CON FONDO DIFUSOR / WITH SANDWICH BOTTOM /  
AVEC FOND THERMO-DIFFUSEUR / MIT SANDWICHBODEN

**PATENTED EXCLUSIVE**

 **INDUCTION**



ESPAÑOL

CUBETAS GN CON FONDO DIFUSOR: ÚNICAS, ADAPTADAS A LA COCCIÓN EN PLACAS DE INDUCCIÓN MEDIANTE FONDO SANDWICH (INOX-ALU-INOX).

ENGLISH

GN CONTAINERS WITH SANDWICH BASE, SUITABLE FOR COOKING DIRECTLY ON ANY KIND OF STOVES INCLUDING INDUCTION.

FRANÇAIS

BACS GN AVEC FOND THERMO-DIFFUSEUR APTE SUR TOUT TYPE DE CUISINIÈRES, SURTOUT EN INDUCTION.

DEUTSCH

GN BEHÄLTER MIT SANDWICHBODEN: EINZIGARTIG, GEEIGNET FÜR DAS KOCHEN AUF INDUKTIONSKOCHFELDERN MITTELS SANDWICHBODEN.

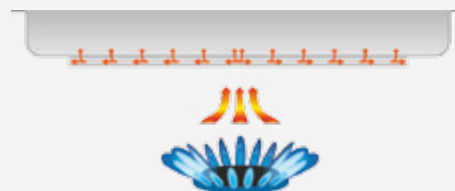

Cubeta GN con fondo difusor / Sandwich bottom GN container /  
Bac GN avec fond thermo-diffuseur / GN Behälter mit Sandwichboden



**PATENTED EXCLUSIVE**



INOX - ST/STEEL  
EDELSTAHL  
18/10



REF	TIPO / TYPE	H mm	Lts	U
P110.4F1	1/1	40	5,10	1
P110.6F1	1/1	65	8,30	1
P111.0F1	1/1	100	14,20	1
P111.5F1	1/1	150	20,20	1
P120.4F1	1/2	40	2,20	1
P120.6F1	1/2	65	4,10	1
P120.0F1	1/2	100	6,10	1
P120.5F1	1/2	150	9,10	1

Cubeta GN con fondo difusor y asas / Sandwich bottom GN container with handles /  
Bac GN avec fond thermo-diffuseur et anses / GN Behälter mit Sandwichboden und Griffen



**PATENTED EXCLUSIVE**



INOX - ST/STEEL  
EDELSTAHL  
18/10



REF	TIPO / TYPE	H mm	Lts	U
P111.0F2	1/1	100	14,20	1
P111.5F2	1/1	150	20,20	1

GASTRONORM POLICARBONATO / POLYCARBONATE GASTRONORM /  
GASTRONORME POLYCARBONATE / GASTRONORM POLYCARBONAT



- 40 °C  
 + 130 °C

ESPAÑOL

UTILIZACIÓN: ALMACENAMIENTO DE PRODUCTOS A GRANEL, INGREDIENTES VARIOS EN NEVERAS O CÁMARAS FRIGORÍFICAS.  
IDEALES PARA PRESENTACIÓN EN BUFFETS FRÍOS.

ENGLISH

USE TO STORE BULK PRODUCTS AND INGREDIENTS IN COOLERS, FREEZERS OR PANTRY.  
HIGHLY RECOMMENDED FOR TRANSPORTATION AND MICROWAVES COOKING.

FRANÇAIS

UTILISATION : STOCKAGE DE PRODUITS ET INGRÉDIENTS EN VRAC DANS LES UNITÉS RÉFRIGÉRÉES OU PLACARDS.  
IDÉAL POUR LE TRANSPORT ET LA CUISSON EN FOUR MICRO-ONDES.

DEUTSCH

GEBRAUCH: LAGERUNG VON UNVERPACKTEN LEBENSMITTEL, VERSCHIEDENEN ZUTATEN IN KÜHLSCHRÄNKEN ODER  
KÜHLKAMMERN.  
IDEAL FÜR DIE PRÄSENTATION DES KALTEN BUFFETS.

**1/1** 530 x 325 mm



REF	H mm	Lts	U
P110.6C1	65	8,70	12
P111.0C1	100	13,30	12
P111.5C1	150	19,60	12
P112.0C1	200	25,50	6

**1/2** 325 x 265 mm

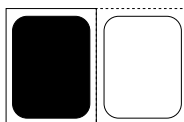

REF	H mm	Lts	U
P120.6C1	65	4,00	30
P121.0C1	100	6,00	24
P121.5C1	150	8,70	24
P122.0C1	200	11,20	18

**1/3** 325 x 175 mm

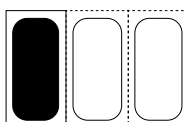

REF	H mm	Lts	U
P130.6C1	65	2,35	18
P131.0C1	100	3,50	12
P131.5C1	150	5,00	12
P132.0C1	200	6,35	6



GASTRONORM POLICARBONATO / POLYCARBONATE GASTRONORM / GASTRONORME POLYCARBONATE / GASTRONORM POLYCARBONAT

**1/4** 265 x 162 mm

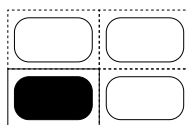

REF	H mm	Lts	U
P140.6C1	65	1,65	18
P141.0C1	100	2,46	18
P141.5C1	150	3,47	12

**1/6** 176 x 162 mm

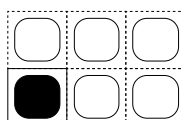

REF	H mm	Lts	U
P160.6C1	65	0,95	30
P161.0C1	100	1,40	24
P161.5C1	150	1,95	24

**1/9** 176 x 108 mm

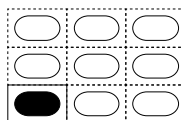

REF	H mm	Lts	U
P190.6C1	65	0,54	30
P191.0C1	100	0,77	30

Tapa policarbonato / Polycarbonate lid / Couvercle Polycarbonate / Polycarbonat Deckel



REF	Mod	U
P110.0C1	1/1	30
P120.0C1	1/2	60
P130.0C1	1/3	30
P140.0C1	1/4	30
P160.0C1	1/6	60
P190.0C1	1/9	30

Fondo perforado / Perforated bottom / Fond perforé / Gelochter Boden



REF	Mod	U
P115.0C1	1/1	36
P125.0C1	1/2	24
P135.0C1	1/3	24
P145.0C1	1/4	30
P165.0C1	1/6	30

Tapa Polinorm® / Polinorm® Lid / Couvercle Polinorm® / Polinorm® Deckel

**PATENTED / EXCLUSIVE**



REF	Mod	U
P110.0 + COLOR	1/1	30
P120.0 + COLOR	1/2	60
P130.0 + COLOR	1/3	30
P140.0 + COLOR	1/4	30
P160.0 + COLOR	1/6	60
P190.0 + COLOR	1/9	30

Adaptable a / Adjustable to / Adaptable à / Einsetzbar:

Cubetas GN inox, PC, sin Bisfenol-A y PP. No aptas para la gama SP3 / St/Steel, PC, Bisphenol-A FREE and PP GN containers. Not for SP3 range / Bacs GN inox, PC, sans Bisphénol-A et PP. Pas pour la gamme SP3 / Edelstahlbehälter GN, PC, ohne Bisphenol-A und PP. Nicht geeignet für SP3

Ref. color tapa /  
Ref. colour lid /  
Ref. couleur couvercle /  
Art.Nr. Deckelfarbe



## CUBETAS GASTRONORM SIN BISFENOL-A / GASTRONORM CONTAINERS, BISPHENOL-A FREE / BACS GASTRONORME SANS BISPHÉNOL-A / GASTRONORM BEHÄLTER OHNE BISFENOL-A



- 40 °C  
+ 90 °C

ESPAÑOL

CUBETAS EN COPOLIESTER SIN BISFENOL-A (100% BPA FREE). ES UN MATERIAL ALTERNATIVO AL POLICARBONATO. CONFORMES CON LA NORMA EUROPEA EN 631.1 (COMPATIBLE CON LOS EQUIPOS Y APARATOS GASTRONORM). EXCELENTE TRANSPARENCIA Y RESISTENCIA A LOS IMPACTOS. IDEALES PARA ALMACENAR PRODUCTOS EN CÁMARAS FRIGORÍFICAS, DE PREPARACIÓN. CUBETAS APILABLES /

ENGLISH

CONTAINERS MADE OF COPOLYESTER WITHOUT BISPHENOL-A (100% BPA FREE). AN ALTERNATIVE MATERIAL TO POLYCARBONATE. COMPLIES WITH EUROPEAN STANDARD EN 631.1 (COMPATIBLE WITH GASTRONORM SYSTEMS AND APPLIANCES) EXCELLENT TRANSPARENCY AND IMPACT RESISTANCE. IDEAL FOR STORING PRODUCTS IN COLD ROOMS, FOR PREPARATION. STACKABLE CONTAINERS /

FRANÇAIS

BACS EN COPOLIESTER SANS BISPHÉNOL-A (100% BPA FREE). IL S'AGIT D'UN MATÉRIAU ALTERNATIF AU POLYCARBONATE. CONFORMES À LA NORME EUROPÉENNE EN 631.1 (COMPATIBLE AVEC LES MACHINES ET APPARELLS GASTRONORM). EXCELLENTE TRANSPARENCE ET RÉSISTANCE AUX CHOCS. IDÉALES POUR EMMAGASINER DES PRODUITS DANS DES CHAMBRES FROIDES, DE PRÉPARATION. CUVETTES EMPILABLES.

DEUTSCH

BEHÄLTER AUS COPOLYESTER OHNE BISFENOL-A (100% BPA FREE). ES IST EIN ALTERNATIVES MATERIAL ZU POLYCARBONAT. ENTSPRECHEND DER EUROPÄISCHEN NORM 631.1 (KOMPATIBEL MIT ALLEN SYSTEMEN UND MASCHINEN GASTRONORM). EXZELLENTER TRANSPARENZ UND RESISTENZ GEGEN STÖSSE. IDEAL ZUM LAGERN VON PRODUKTEN IN KÜHLKAMMERN, ZUR VORBEREITUNG. BEHÄLTER STAPELBAR.

**1/1** 530 x 325 mm



REF	H mm	Lts	U
P110.6BF	65	8,70	12
P111.0BF	100	13,30	12
P111.5BF	150	19,60	12

**1/2** 325 x 265 mm

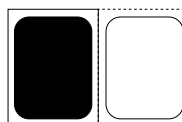

REF	H mm	Lts	U
P120.6BF	65	4,00	30
P121.0BF	100	6,00	24
P121.5BF	150	8,70	24

**1/3** 325 x 175 mm

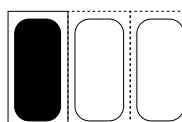

REF	H mm	Lts	U
P130.6BF	65	2,35	18
P131.0BF	100	3,50	12
P131.5BF	150	5,00	12

CUBETAS GASTRONORM SIN BISFENOL-A / GASTRONORM CONTAINERS, BISPHENOL-A FREE / BACS GASTRONORME SANS BISPHÉNOL-A / GASTRONORM BEHÄLTER OHNE BISFENOL-A

**1/4** 265 x 162 mm

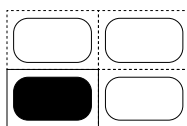

REF	H mm	Lts	U
P140.6BF	65	1,65	18
P141.0BF	100	2,46	18
P141.5BF	150	3,47	12

**1/6** 176 x 162 mm

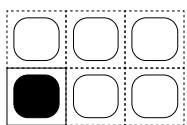

REF	H mm	Lts	U
P160.6BF	65	0,95	30
P161.0BF	100	1,40	24
P161.5BF	150	1,95	24

**1/9** 176 x 108 mm

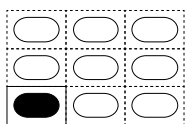

REF	H mm	Lts	U
P190.6BF	65	0,54	30
P191.0BF	100	0,77	30

Tapa gastronorm / Gastronorm lid / Couvercle gastronorme / Gastronorm Deckel



REF	Mod	U
P110.0BF	1/1	30
P120.0BF	1/2	60
P130.0BF	1/3	30
P140.0BF	1/4	30
P160.0BF	1/6	60
P190.0BF	1/9	30

Fondo perforado / Perforated bottom / Fond perforé / Gelochter Boden



REF	Mod	U
P115.0BF	1/1	36
P125.0BF	1/2	24
P135.0BF	1/3	24
P145.0BF	1/4	30
P165.0BF	1/6	30

Tapa Polinorm® / Polinorm® Lid / Couvercle Polinorm® / Polinorm® Deckel

**PATENTED EXCLUSIVE**



REF	Mod	U
P110.0 + COLOR	1/1	30
P120.0 + COLOR	1/2	60
P130.0 + COLOR	1/3	30
P140.0 + COLOR	1/4	30
P160.0 + COLOR	1/6	60
P190.0 + COLOR	1/9	30

Adaptable a / Adjustable to / Adaptable à / Einsetzbar:

Cubetas GN inox, PC, sin Bisfenol-A y PP. No aptas para la gama SP3 / St/Steel, PC, Bisphenol-A FREE and PP GN containers. Not for SP3 range / Bacs GN inox, PC, sans Bisphénol-A et PP. Pas pour la gamme SP3 / Edelstahlbehälter GN, PC, ohne Bisphenol-A und PP. Nicht geeignet für SP3

Ref. color tapa / Ref. colour lid / Ref. couleur couvercle / Art.Nr. Deckelfarbe



TRANSPORTE Y ALMACENAMIENTO / TRANSPORT & STORAGE / TRANSPORT ET STOCKAGE

**GASTRONORM POLIPROPILENO / POLYPROPYLENE GASTRONORM /  
GASTRONORME POLYPROPYLÈNE / POLYPROPYLEN GASTRONORM**
**PATENTED / EXCLUSIVE**

 - 40 °C  
 + 110 °C

ESPAÑOL

UTILIZACIÓN: ALMACENAMIENTO DE PRODUCTOS A GRANEL, INGREDIENTES VARIOS EN NEVERAS O CÁMARAS FRIGORÍFICAS.  
IDEAL PARA TRANSPORTE Y COCCIÓN EN MICROONDAS.

ENGLISH

USE TO STORE BULK PRODUCTS AND INGREDIENTS IN COOLERS, FREEZERS OR PANTRY.  
HIGHLY RECOMMENDED FOR TRANSPORTATION AND MICRO-WAVES COOKING.

FRANÇAIS

UTILISATION : STOCKAGE DE PRODUITS ET INGRÉDIENTS EN VRAC DANS DES UNITÉS RÉFRIGÉRÉES OU PLACARDS.  
IDÉAL POUR LE TRANSPORT ET LA CUISSON EN FOUR MICRO-ONDES.

DEUTSCH

GEBRAUCH: LAGERUNG VON UNVERPACKTEN LEBENSMITTEL, VERSCHIEDENEN ZUTATEN IN KÜHLSCHRÄNKEN ODER  
KÜHLKAMMERN.  
IDEAL FÜR DEN TRANSPORT ODER ZUM KOCHEN IN MIKROWELLEN.

**Tapa Polinorm® / Polinorm® Lid / Couvercle Polinorm® / Polinorm® Deckel**
**PATENTED / EXCLUSIVE**

REF	Mod	U
P110.0 + COLOR	1/1	30
P120.0 + COLOR	1/2	60
P130.0 + COLOR	1/3	30
P140.0 + COLOR	1/4	30
P160.0 + COLOR	1/6	60
P190.0 + COLOR	1/9	30

Adaptable a / Adjustable to / Adaptable à / Einsetzbar:

Cubetas GN inox, PC, sin Bisfenol-A y PP. No aptas para la gama SP3 /  
St/Steel, PC, Bisphenol-A FREE and PP GN containers. Not for SP3 range /  
Bacs GN inox, PC, sans Bisphénol-A et PP. Pas pour la gamme SP3 /  
Edelstahlbehälter GN, PC, ohne Bisphenol-A und PP. Nicht geeignet für SP3

 Ref. color tapa /  
Ref. colour lid /  
Ref. couleur couvercle /  
Art.Nr. Deckelfarbe

**1/1** 530 x 325 mm

REF	H mm	Lts	U
P110.6P1	65	8,70	12
P111.0P1	100	13,30	12
P111.5P1	150	19,60	12
P112.0P1	200	25,50	6

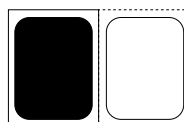
**1/2** 325 x 265 mm

REF	H mm	Lts	U
P120.6P1	65	4,00	30
P121.0P1	100	6,00	24
P121.5P1	150	8,70	24
P122.0P1	200	11,20	18



GASTRONORM POLIPROPILENO / POLYPROPYLENE GASTRONORM / GASTRONORME POLYPROPYLENE / POLYPROPYLEN GASTRONORM

**1/3** 325 x 175 mm

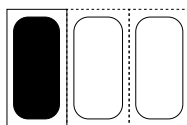

REF	H mm	Lts	U
P130.6P1	65	2,35	18
P131.0P1	100	3,50	12
P131.5P1	150	5,00	12
P132.0P1	200	6,35	6

**1/4** 265 x 162 mm

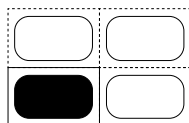

REF	H mm	Lts	U
P140.6P1	65	1,65	18
P141.0P1	100	2,46	18
P141.5P1	150	3,47	12

**1/6** 176 x 162 mm

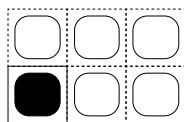

REF	H mm	Lts	U
P160.6P1	65	0,95	30
P161.0P1	100	1,40	24
P161.5P1	150	1,95	24

**1/9** 176 x 108 mm

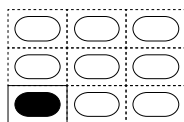

REF	H mm	Lts	U
P190.6P1	65	0,54	30
P191.0P1	100	0,77	30

Tapa policarbonato / Polycarbonate lid / couvercle Polycarbonate / Polycarbonat Deckel



REF	Mod	U
P110.0C1	1/1	30
P120.0C1	1/2	60
P130.0C1	1/3	30
P140.0C1	1/4	30
P160.0C1	1/6	60
P190.0C1	1/9	30

Fondo perforado / Perforated bottom / Fond perforé / Gelochter Boden



REF	Mod	U
P115.0P1	1/1	36
P125.0P1	1/2	24
P135.0P1	1/3	24
P145.0P1	1/4	30
P165.0P1	1/6	30







# FLAP RACK®

by **pujadas**  
A VOLLRATH® COMPANY

**PATENTED** / **EXCLUSIVE**

**SISTEMA DE MONTAJE Y DESMONTAJE FÁCIL, SEGURO Y SENCILLA PERSONALIZACIÓN /**  
**EASY ASSEMBLY AND DISASSEMBLY SYSTEM, SAFE AND SIMPLE CUSTOMIZATION /**  
**SYSTÈME DE MONTAGE ET DÉMONTAGE FACILE, SÛR ET DE SIMPLE PERSONNALISATION /**  
**EINFACHES MONTAGE- UND DEMONTAGESYSTEM, SICHERE UND EINFACHE PERSONALISIERUNG**

**APILABLES CON OTRAS CESTAS DEL MERCADO, REFUERZO DE DOBLE PARED (ANTI-GOLPES) /**  
**STACKABLE WITH OTHER MARKET RACKS REINFORCED DOUBLE-WALL (ANTI-SHOCK) /**  
**EMPILABLE AVEC D'AUTRES PANIERS DU MARCHÉ, RENFORCÉ AVEC DOUBLE PAROI (ANTI-CHOC) /**  
**STAPELBAR MIT ANDEREN KÖRBE AUF DEM MARKT, VERSTÄRKT MIT DOPPELWAND (ANTI-STOSS)**

## ABIERTA / OPENED / OUVERT / OFFEN

APERTURAS PARA MÁXIMA LIMPIEZA  
 OPENINGS FOR MAXIMUM CLEANING  
 OUVERTURES POUR UN NETTOYAGE PERFORMANT  
 ÖFFNUNGEN FÜR MAXIMALE REINIGUNG

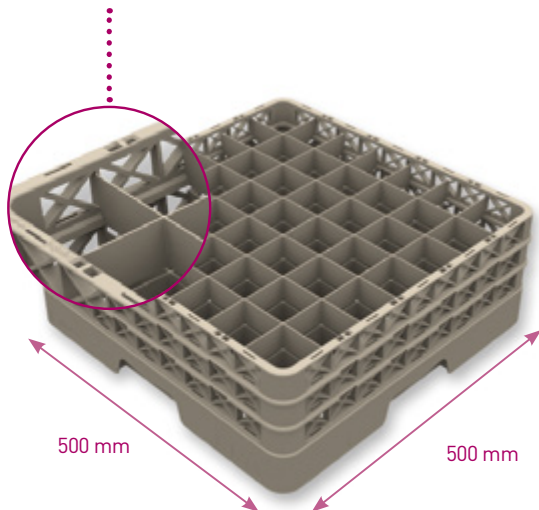

## CERRADA / CLOSED / FERMÉ / GESCHLOSSEN

IDEALES PARA EL TRANSPORTE Y EL ALMACENAMIENTO  
 IDEAL FOR TRANSPORTING AND STORING  
 IDÉAL POUR LE TRANSPORT ET LE STOCKAGE  
 IDEAL FÜR DEN TRANSPORT UND LAGERUNG

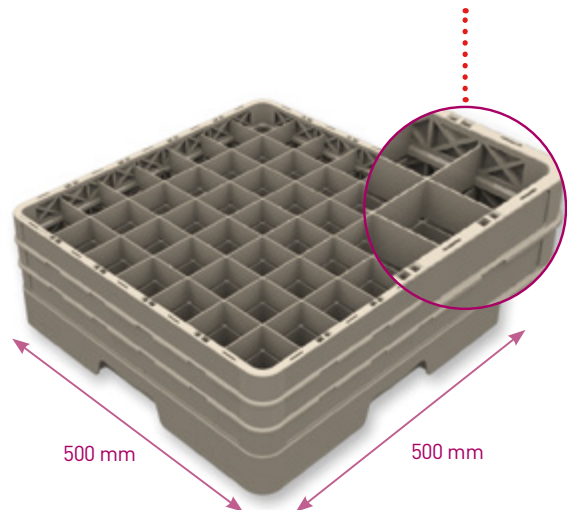

ESCOGER LO BUENO Y LO MEJOR A LA VEZ\* /  
 GET THE BEST OF BOTH WORLDS\* /  
 LE BON ET LE MEILLEUR À LA FOIS\* /  
 NEHMEN SIE DAS GUTE UND DAS BESTE AUF EINMAL\*

FLAP-RACK®: fácil montaje / desmontaje  
 FLAP-RACK®: easy to assembly / disassembly  
 FLAP-RACK®: facile à monter / démonter  
 FLAP-RACK®: Einfache Montage / Demontage

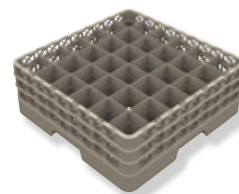
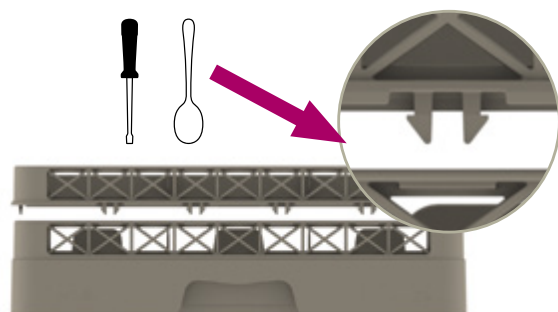

LAVADO: Mayor limpieza  
 WASHING: Higher cleaning  
 LAVAGE: MEILLEUR NETTOYAGE  
 REINIGUNG: Bessere Reinigung



TRANSPORTE: Mayor seguridad  
 TRANSPORT: Higher security  
 TRANSPORT: Plus de sécurité  
 TRANSPORT: Höhere Sicherheit

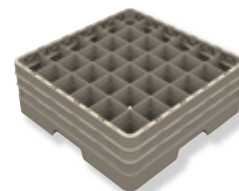

ALMACENAMIENTO: Mayor Higiene  
 STORING: Higher hygiene  
 STOCKAGE: Plus hygiénique  
 LAGERUNG: Höhere Hygiene

\* Copolímero altamente resistente a sustancias químicas y temperaturas de hasta 95 °C.  
 \* Copolymer highly resistant to chemical products and temperatures up to 95 °C.  
 \* Copolymère très résistant aux produits chimiques et à températures jusqu'à 95 °C.  
 \* Copolymer höchster Widerstand gegen chemische Substanzen und Temperaturen bis zu 95 °C.



# FLAP RACK® by pujadas®

A VOLLRATH® COMPANY

SISTEMA PATENTADO QUE PERMITE CERRAR Y ABRIR LAS PAREDES DE LAS CESTAS Y EXTENSIONES FÁCILMENTE

SYSTEM PATENTED ALLOWS THE WALLS ON BOTH BASES AND EXTENDERS TO BE CLOSED OR OPEN EASILY

SYSTÈME BREVETÉ QUI PERMET D'OUVRIER OU DE FERMER FACILEMENT LES PAROIS DES CASIERS ET DES RÉHAUSSES

PATENTIERTES SYSTEM, WELCHES DAS EINFACHE ÖFFNEN UND SCHLIESSEN DER SPÜLKORBWÄNDE UND DIE VERGRÖSSERUNG ERLAUBT.

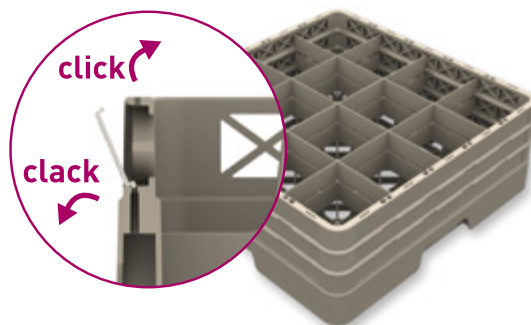

## FLAP IDENTIFICADOR

Identificador de colores para cestas y extensiones completamente cerradas. Disponible en 6 colores. Posibilidad de marcar logo cliente.

Colour identification for completely closed racks and extensions. Available in 6 colours. Possible personalisation.

Identificateur en couleurs pour casiers et réhausses complètement fermés. Disponible en 6 couleurs. Personnalisation possible.

Farbindentifikation für Spülkörbe und Vergrößerungen komplett geschlossen. Erhältlich in 6 Farben. Möglichkeit der Markierung mit dem Firmenlogo.



F1 marrón  
brown  
marron  
braun



F4 amarillo  
yellow  
jaune  
gelb



F2 burdeos  
burgundy  
bordeaux  
bordeauxrot



F5 verde  
green  
vert  
grün



F3 azul  
blue  
bleu  
blau



F6 marrón oscuro  
dark brown  
marron foncé  
dunkelbraun



Logo o texto impreso / Printed logo or text /  
Logo ou texte imprimé / Logo oder Text gedruckt



Logo o texto estampado / Hot stamped logo or text /  
Logo ou texte gravé / Logo oder Text gestempelt



## 501F Flap

### FLAP RACK®

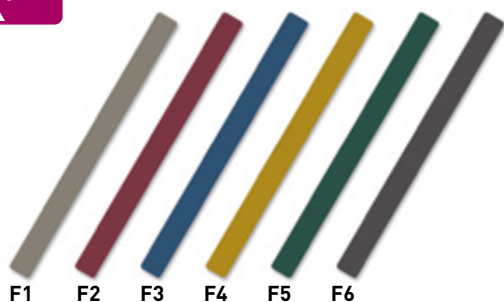

F1 F2 F3 F4 F5 F6

REF	COLOR / COLOUR / COULEUR / FARBE	U
P501 F1	Marrón / Brown / Marrón / Braun	24
P501 F2	Burdeos / Burgundy / Bordeaux / Bordeauxrot	24
P501 F3	Azul / Blue / Bleu / Blau	24
P501 F4	Amarillo / Yellow / Jaune / Gelb	24
P501 F5	Verde / Green / Vert / Grün	24
P501 F6	Marrón oscuro / Dark brown / Marrón foncé / Dunkelbraun	24

# TRAEX → T-VERSION

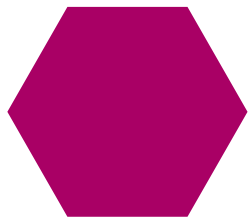

DISEÑADAS CON UN 17-30% MÁS DE CAPACIDAD PARA VASOS Y COPAS QUE LAS CESTAS TRADICIONALES

DESIGNED TO HOLD 17-30% MORE GLASSWARE THAN A TRADITIONAL RACK

CONÇUS POUR CONTENIR DE 17 À 30 % DE VERRES EN PLUS QU'UN CASIER TRADITIONNEL

NIMMT 17-30 % MEHR GLASER AUF ALS KONVENTIONELLE SPULKORBE

EXTENSORES A PRESIÓN  
No se sueltan con el tiempo

SNAP-FIT EXTENDERS  
Will not loosen or come apart over time

LES EXTENSIONS À ENCLÈCHEMENT  
No se délogeront pas au fil des ans

AUFSCHNAPPVERLÄNGERUNGEN  
Lösen sich im Laufe der Zeit nicht voneinander ab

DISEÑO DE PERFIL ABIERTO  
Permite un lavado y secado de arriba a abajo y de lado a lado

OPEN PROFILE DESIGN  
Allows top-to-bottom and side-to-side washing and drying

LE CONCEPT À PROFIL OUVERT  
Permet un lavage et un séchage de haut en bas et d'un côté à l'autre

OFFENES DESIGN  
Ermöglicht Waschen und Trocknen von oben nach unten und von einer Seite zur anderen

MANEJO CÓMODO  
Con asas en los cuatro lados

CONVENIENT HANDLING  
With handles an all four sides

MANIPULATION PRATIQUE G  
râce aux poignées des quatre côtés

PRAKTISCHE TRAGEVORRICHTUNG  
Mit Griffen an allen vier Seiten

LOS DIVISORES INCORPORADOS  
brindan una protección 100% vertical de los vasos y las copas

BUILT-IN BASE RACK DIVIDERS  
provide 100% vertical glassware protection

LES PARTITIONS DE CASIER DE BASE INTÉGRÉES  
offrent une protection des verres 100% verticale

INTEGRIERTE KORBBODEN-TRENNEINSÄTZE  
bieten 100-prozentigen vertikalen Schutz vor Glasbruch

LOS COMPARTIMENTOS LATERALES PEQUEÑOS  
aceptan cubiertos, saleros, potes, ...

SMALL SIDE COMPARTMENTS  
hold flatware, salt shakers, ramekins, ...

LES PETITS COMPARTIMENTS LATÉRAUX  
contiennent couverts, salières, ramequins, ...

KLEINA SEITENFÄCHER  
nehmen Besteck, Salzstreuer, Auflaufformen und mehr auf

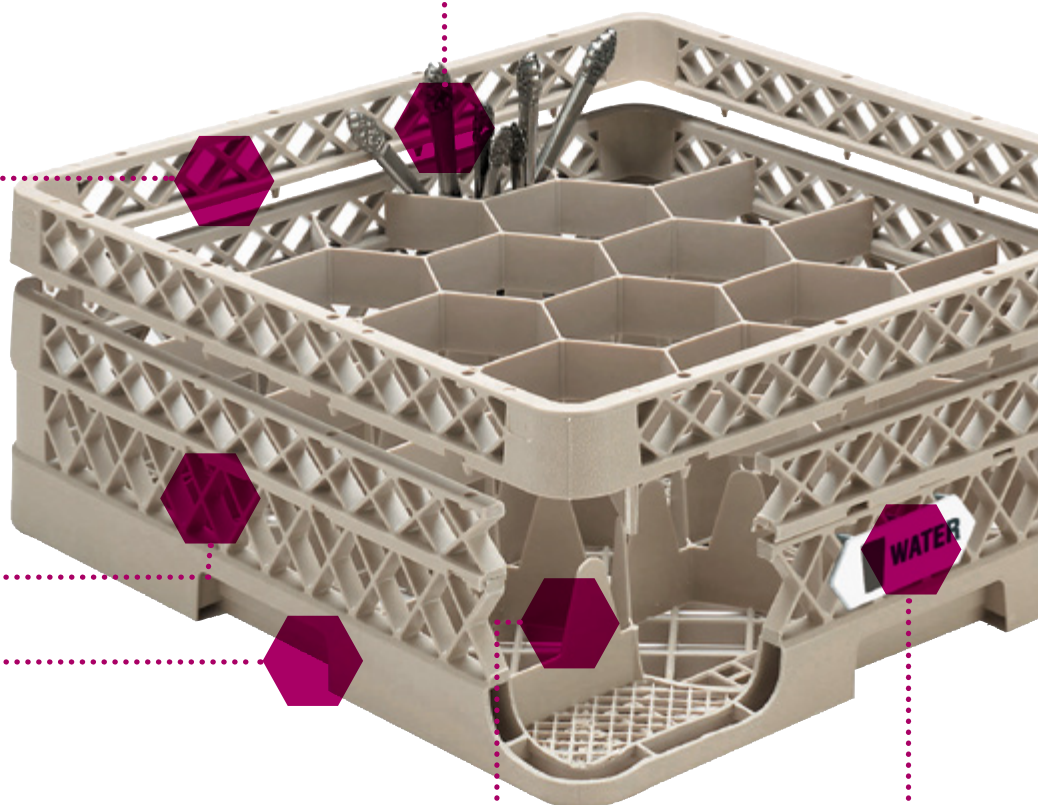

CLIPS DE IDENTIFICACIÓN DE COLORES  
para facilitar la identificación

COLOUR IDENTIFICATION CLIP  
for easy identification

CLIPS IDENTIFICATEUR EN COULEURS  
pour une identification plus facile

FARBIDENTIFIKATION  
zur einfachen Kennzeichnung

## CLIP

Clip identificación / Clip tags /  
Clip d'identification / Klippidentifizierung

### T-VERSION

C1/01	Marrón / Brown / Marron / Braun	C4/08	Amarillo / Yellow / Jaune / Gelb
C2/02	Rojo / Red / Rouge / Rot	C5/19	Verde / Green / Vert / Grün
C6/03	Naranja / Orange / Orange / Orange	C9/32	Beige / Beige / Beige / Beige
C3/04	Azul / Blue / Bleu / Blau		
C7/05	Blanco / White / Blanc / Weiss		
C8/06	Negro / Black / Noir / Schwarz		



REF		U
1009-01		1
1009-02		1
1009-03		1
1009-04		1
1009-05		1
1009-06		1
1009-08		1
1009-19		1
1009-32		1

SELECCIÓN CESTAS PARA VAJILLA / DISHWASHER RACKS SELECTION / SÉLECTION CASIERS À VAISSELLE / AUSWAHLÜBERSICHT SPÜLMASCHINENKÖRBE

	<b>FLAP RACK®</b>	<b>T-VERSION</b>	<i>Signature</i>
FLAPS	✓	✗	✗
CLIP IDENTIFICACIÓN / CLIP TAGS / CLIP D'IDENTIFICATION / KLIPPIDENTIFIZIERUNG	✗	✓	✓
CESTAS ABIERTAS / OPENED RACKS / PANIER OUVERTS / SPÜLKORB OFFENES	✓	✓	✓
CESTAS CERRADAS / CLOSED RACKS / PANIER FERMÉES / SPÜLKORB GESCHLOSSENES	✓	✗	✗
CESTAS MEDIO TAMAÑO / HALF-SIZE RACKS / CASIERS DEMI-TAILLE / SPÜLKÖRBE IN HALBGRÖÖE	✗	✓	✗
DESMONTABLE / DISASSEMBLY / DÉMONTER / DEMONTAGE	✓	✗	✓
COMPARTIMENTOS / COMPARTMENTS / COMPARTIMENTS / FÄCHER 	✓	✓	✓
COMPARTIMENTOS / COMPARTMENTS / COMPARTIMENTS / FÄCHER 	✗	✓	✓
	✓	✓	✓

TRANSPORTE Y ALMACENAMIENTO /  
TRANSPORT & STORAGE /  
TRANSPORT ET STOCKAGE



## ABIERTAS / OPENED / OUVERTS / OFFEN

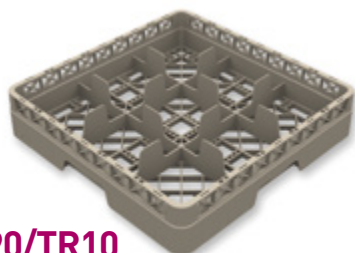

 Ø max. 151 mm
**FLAP RACK®**

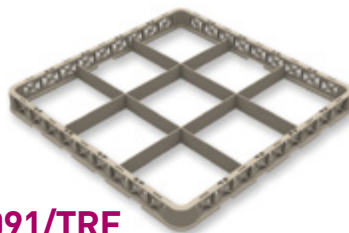
**P5090/TR10**  
BASE 9 COMPART.



**P5091/TRF**  
EXT. 9 COMPART.

REF NOW	REF BEFORE	U
P5090	TR10	6
P5091	TRF	12

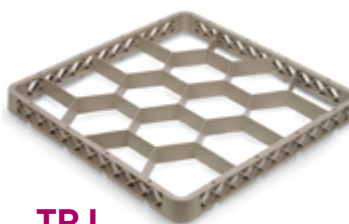

 Ø max. 122 mm
**T-VERSION**

**TR18**  
BASE 12 COMPART.

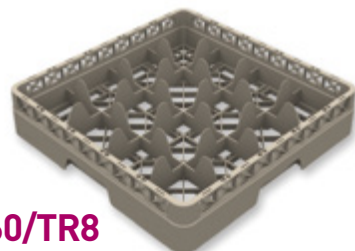

**TRJ**  
EXT. 12 COMPART.

REF NOW	REF BEFORE	U
TR18		6
TRJ		12

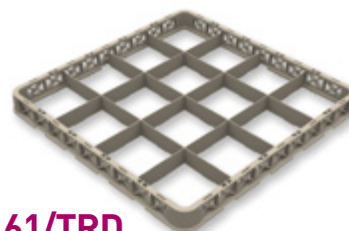

 Ø max. 113 mm
**FLAP RACK®**

**P5160/TR8**  
BASE 16 COMPART.



**P5161/TRD**  
EXT. 16 COMPART.

REF NOW	REF BEFORE	U
P5160	TR8	6
P5161	TRD	12

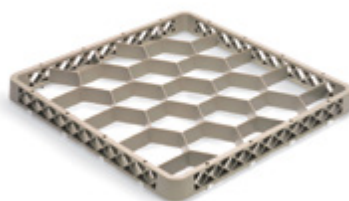

 Ø max. 100 mm
**T-VERSION**

**TR11**  
BASE 20 COMPART.

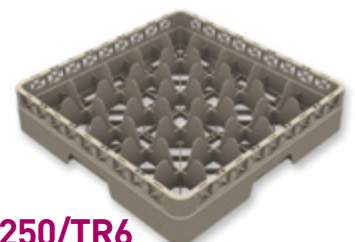

**TRG**  
EXT. 20 COMPART.

REF	REF BEFORE	U
TR11		6
TRG		12

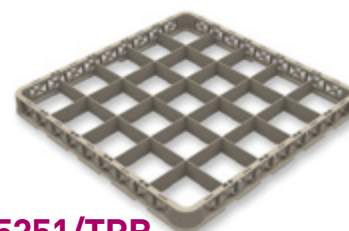

 Ø max. 89 mm
**FLAP RACK®**

**P5250/TR6**  
BASE 25 COMPART.



**P5251/TRB**  
EXT. 25 COMPART.

REF NOW	REF BEFORE	U
P5250	TR6	6
P5251	TRB	12





 Ø max. 81 mm

**T-VERSION**



**TR12**  
BASE 30 COMPART.

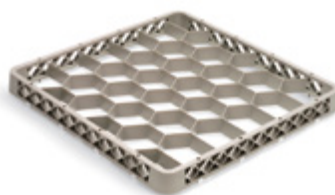

**TRH**  
EXT. 30 COMPART.

REF	U
TR12	6
TRH	12



 Ø max. 73 mm

**FLAP RACK®**

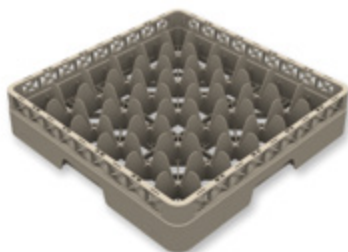

**P5360/TR7**  
BASE 36 COMPART.

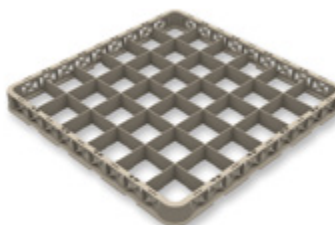

**P5361/TRC**  
EXT. 36 COMPART.

REF NOW	REF BEFORE	U
P5360	TR7	6
P5361	TRC	12



 Ø max. 70 mm

**T-VERSION**

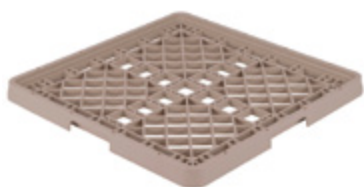

**TR13**  
BASE 42 COMPART.



**TRM**  
EXT. 42 COMPART.

REF	U
TR13	6
TRM	12



 Ø max. 63 mm

**FLAP RACK®**

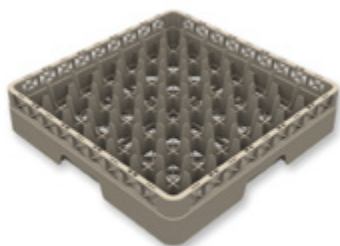

**P5490/TR9**  
BASE 49 COMPART.

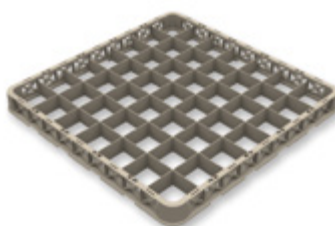

**P5491/TRE**  
EXT. 49 COMPART.

REF NOW	REF BEFORE	U
P5490	TR9	6
P5491	TRE	12



TRANSPORTE Y ALMACENAMIENTO /  
TRANSPORT & STORAGE /  
TRANSPORT ET STOCKAGE

## MONTADAS ABIERTAS / OPENED ASSEMBLED / MONTÉS OUVERTS / OFFENE MONTAGE

 Ø max. 151 mm

9 COMPART.

**FLAP  
RACK®**

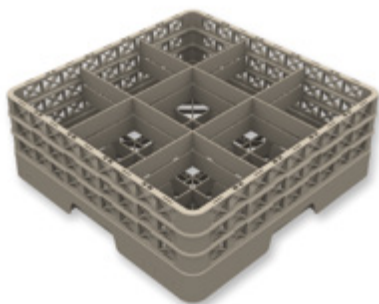

REF NOW	REF BEFORE	 max. (mm)	H (mm)*
P5090 E1	TR10 F	120	140
P5090 E2	TR10 FF	160	180
P5090 E3	TR10 FFF	200	220
P5090 E4	TR10 FFFF	240	260
P5090 E5	TR10 FFFFF	280	300

 Ø max. 122 mm

12 COMPART.

**T-VERSION**





REF	 max. (mm)	H (mm)*
TR18 J	122	140
TR18 JJ	162	181
TR18 JJJ	200	222
TR18 JJJJ	240	262
TR18 JJJJJ	279	302

 Ø max. 113 mm

16 COMPART.

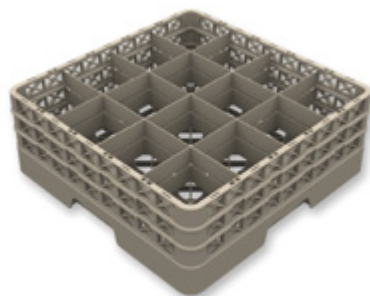
**FLAP  
RACK®**



REF NOW	REF BEFORE	 max. (mm)	H (mm)*
P5160 E1	TR8 D	120	140
P5160 E2	TR8 DD	160	180
P5160 E3	TR8 DDD	200	220
P5160 E4	TR8 DDDD	240	260
P5160 E5	TR8 DDDDD	280	300

 Ø max. 100 mm

20 COMPART.

**T-VERSION**





REF	 max. (mm)	H (mm)*
TR11 G	122	140
TR11 GG	162	181
TR11 GGG	200	222
TR11 GGGG	240	262
TR11 GGGGG	279	302

 Ø max. 89 mm

25 COMPART.

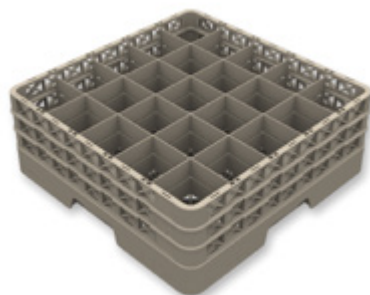
**FLAP  
RACK®**



REF NOW	REF BEFORE	 max. (mm)	H (mm)*
P5250 E1	TR6 B	120	140
P5250 E2	TR6 BB	160	180
P5250 E3	TR6 BBB	200	220
P5250 E4	TR6 BBBB	240	260
P5250 E5	TR6 BBBBB	280	300

 Ø max. 81 mm

30 COMPART.

**T-VERSION**





REF	 max. (mm)	H (mm)*
TR12 H	122	140
TR12 HH	162	181
TR12 HHH	200	222
TR12 HHHH	240	262
TR12 HHHHH	279	302

 Ø max. 73 mm

36 COMPART.

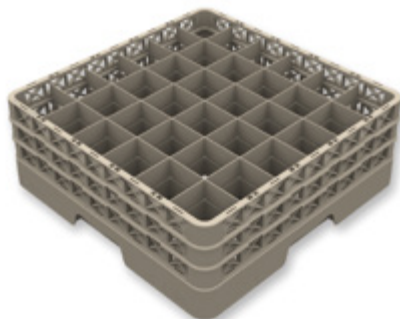
**FLAP RACK**



REF NOW	REF BEFORE	 max. (mm)	H (mm)*
P5360 E1	TR7 C	120	140
P5360 E2	TR7 CC	160	180
P5360 E3	TR7 CCC	200	220
P5360 E4	TR7 CCCC	240	260
P5360 E5	TR7 CCCCC	280	300

 Ø max. 70 mm

42 COMPART.

**T-VERSION**





REF	 max. (mm)	H (mm)*
TR13 M	52	73
TR13 MM	91	114
TR13 MMM	130	156
TR13 MMMM	172	194

 Ø max. 63 mm

49 COMPART.

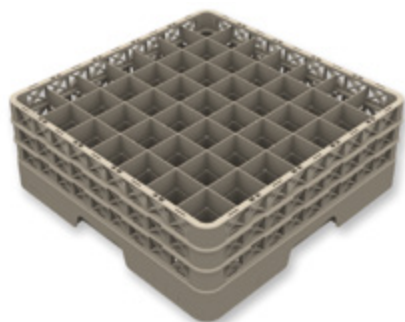
**FLAP RACK**



REF NOW	REF BEFORE	 max. (mm)	H (mm)*
P5490 E1	TR9 E	120	140
P5490 E2	TR9 EE	160	180
P5490 E3	TR9 EEE	200	220
P5490 E4	TR9 EEEE	240	260
P5490 E5	TR9 EEEEE	280	300

\* Altura total del conjunto  
 \* Total set height  
 \* Hauteur totale lot  
 \* Gesamthöhe des Sets

## CERRADAS / CLOSED / FERMÉS / GESCHLOSSEN

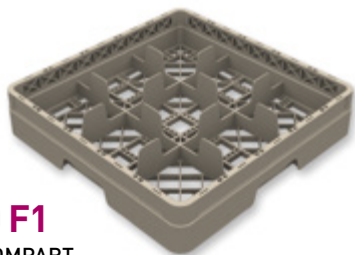
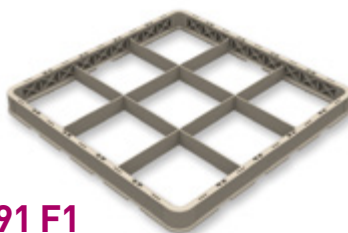

Ø max. 151 mm

**FLAP  
RACK®****P5090 F1**  
BASE 9 COMPART.**P5091 F1**  
EXT. 9 COMPART.

REF	U
P5090 F1	6
P5091 F1	12

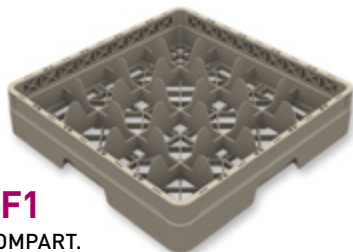

Ø max. 113 mm

**FLAP  
RACK®****P5160 F1**  
BASE 16 COMPART.**P5161 F1**  
EXT. 16 COMPART.

REF	U
P5160 F1	6
P5161 F1	12

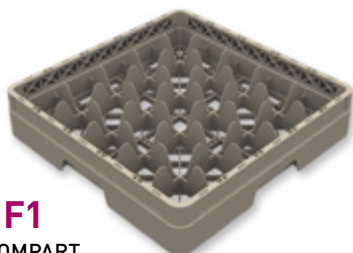
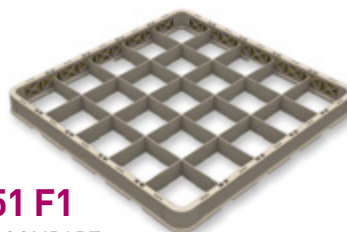

Ø max. 89 mm

**FLAP  
RACK®****P5250 F1**  
BASE 25 COMPART.**P5251 F1**  
EXT. 25 COMPART.

REF	U
P5250 F1	6
P5251 F1	12

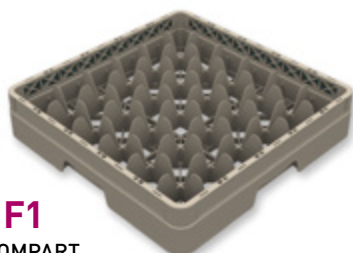
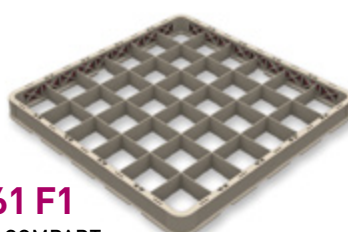

Ø max. 73 mm

**FLAP  
RACK®****P5360 F1**  
BASE 36 COMPART.**P5361 F1**  
EXT. 36 COMPART.

REF	U
P5360 F1	6
P5361 F1	12

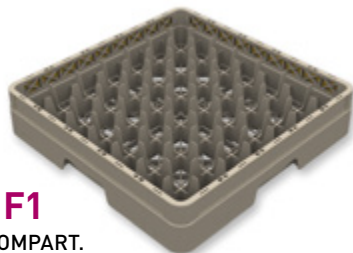
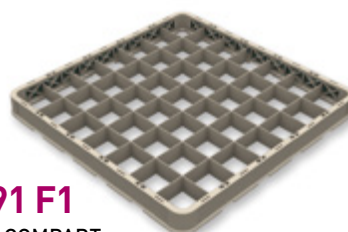

Ø max. 63 mm

**FLAP  
RACK®****P5490 F1**  
BASE 49 COMPART.**P5491 F1**  
EXT. 49 COMPART.

REF	U
P5490 F1	6
P5491 F1	12

Indicar el código de color al final de la referencia.  
Indicate the colour code at the end of the item reference.  
Indiquer le code de couleur a la fin de la référence.  
Angabe des Farbcodes am Ende der Artikelnummer.



F1



F2



F3



F4



F5



F6

**FLAP  
RACK®**



∅ max. 151 mm

9 COMPART.

**FLAP RACK®**

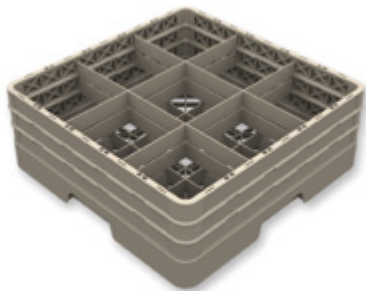

REF	max. (mm)	H (mm)*
P5090 E1F1	120	140
P5090 E2F1	160	180
P5090 E3F1	200	220
P5090 E4F1	240	260
P5090 E5F1	280	300

∅ max. 113 mm

16 COMPART.

**FLAP RACK®**

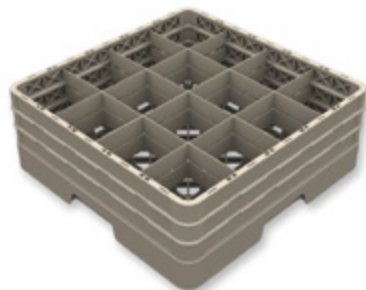

REF	max. (mm)	H (mm)*
P5160 E1F1	120	140
P5160 E2F1	160	180
P5160 E3F1	200	220
P5160 E4F1	240	260
P5160 E5F1	280	300

∅ max. 89 mm

25 COMPART.

**FLAP RACK®**



REF	max. (mm)	H (mm)*
P5250 E1F1	120	140
P5250 E2F1	160	180
P5250 E3F1	200	220
P5250 E4F1	240	260
P5250 E5F1	280	300

∅ max. 73 mm

36 COMPART.

**FLAP RACK®**

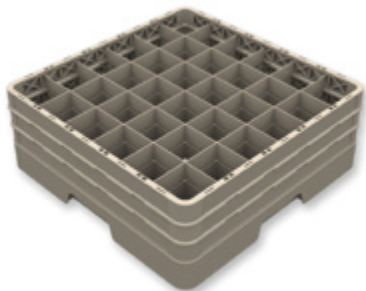

REF	max. (mm)	H (mm)*
P5360 E1F1	120	140
P5360 E2F1	160	180
P5360 E3F1	200	220
P5360 E4F1	240	260
P5360 E5F1	280	300

∅ max. 63 mm

49 COMPART.

**FLAP RACK®**

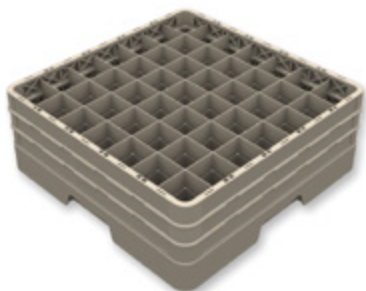

REF	max. (mm)	H (mm)*
P5490 E1F1	120	140
P5490 E2F1	160	180
P5490 E3F1	200	220
P5490 E4F1	240	260
P5490 E5F1	280	300

\* Altura total del conjunto  
 \* Total set height  
 \* Hauteur totale lot  
 \* Gesamthöhe des Sets

Indicar el código de color al final de la referencia.  
 Indicate the colour code at the end of the item reference.  
 Indiquer le code de couleur a la fin de la référence.  
 Angabe des Farbcodes am Ende der Artikelnummer.

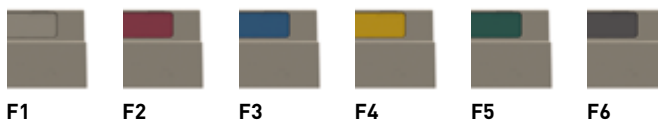

**FLAP RACK®**

TRANSPORTE Y ALMACENAMIENTO /  
 TRANSPORT & STORAGE /  
 TRANSPORT ET STOCKAGE

## CESTAS PARA TAZAS / CUP RACKS / CASIERS À TASSES / TASSENKÖRBE



 Ø max. 113 mm

16 COMPART.

**T-VERSION****TR4****TRD**

REF	H cm	∇ max. (mm)	U
TR4	10,2	8,3	6
TR4 D	14	12,2	2
TR4 DD	18,1	16,2	2
TR4 DDD	22,2	20	2
TR4 DDDD	26,2	24	2
TRD*			12

\*Compatible con las cestas T-Version.  
Compatible with T-Version dishwasher racks.  
Compatible avec les casiers de lavage T-Version.  
Kompatibel mit den Körbe T-Version.



 Ø max. 89 x 113 mm

20 COMPART.

**T-VERSION****TR5****TRA**

REF	H cm	∇ max. (mm)	U
TR5	10,2	8,3	6
TR5 A	14	12,2	2
TR5 AA	18,1	16,2	2
TRA*			12

\*Compatible con las cestas T-Version.  
Compatible with T-Version dishwasher racks.  
Compatible avec les casiers de lavage T-Version.  
Kompatibel mit den Körbe T-Version.

 Ø max. 89 mm

25 COMPART.

**T-VERSION****TR5****TRB**

REF	H cm	∇ max. (mm)	U
TR16	10,2	8,3	6
TR16 B	14	12,2	2
TR16 BB	18,1	16,2	2
TR16 BBB	22,2	20	2
TR16 BBBB	26,2	24	2
TRB*			12

\*Compatible con las cestas T-Version.  
Compatible with T-Version dishwasher racks.  
Compatible avec les casiers de lavage T-Version.  
Kompatibel mit den Körbe T-Version.

**TRICE 16**Cargador de hielo / Ice filler /  
Remplisseuse à glaçons / Eisfüller

50 x 50 cm

REF	COMPARTIMENTOS / COMPARTMENTS / COMPARTIMENTS / FÄCHER	U
TRICE 16	16	3
TRICE 25	25	3
TRICE 36	36	3

**TR13 KKKK**Cestas para jarras / Pitcher racks  
Casiers à pichets / Krugspülkörbe**T-VERSION**

REF	EXTENSIONES / EXTENDERS / EXTENSIONS / VERLÄNGERUNGEN	H cm INTERIOR / INSIDE / INTÉRIEURE / BESCHREIBUNG	H cm EXTERIOR / OUTSIDE / EXTÉRIEURE / AUSSENDURCH	U
TR13 KKKK	4	17,2	19,4	2
TR13 KKKKK	5	21,3	23,3	2
TR13 KKKKKK	6	25,4	27,0	1

5 Compartimentos.  
5 Compartments.  
5 Compartiments.  
5 Fächer

**P5002** Cesta universal / Open rack / Panier universel / Universalspülkorb

**FLAP RACK®**

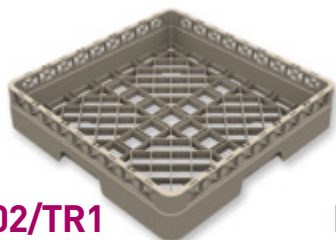

**P5002/TR1**

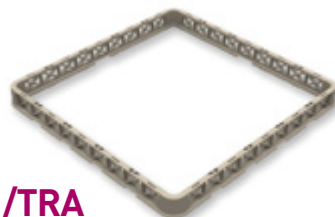

**P5001/TRA**

REF NOW	REF BEFORE	U
P5002	TR1	6
P5001	TRA	12

Compatible con las cestas FlapRack®.  
Compatible with FlapRack® dishwasher racks.  
Compatible avec les casiers de lavage FlapRack®.  
Kompatibel mit den Körbe FlapRack®.

**P5000** Cesta para platos, bandejas y cubiertos / Plate, tray and cutlery baskets / Paniers pour plats, plateaux et couverts / Lagerbehälter und Körbe für Geschirr, Besteck und Tablett

**FLAP RACK®**

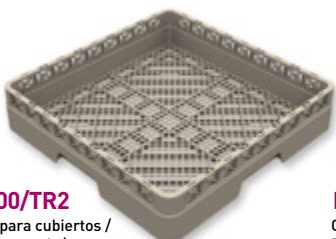

**P5000/TR2**  
Cesta para cubiertos / Flatware rack / Panier a couverts / Besteckspülkorb

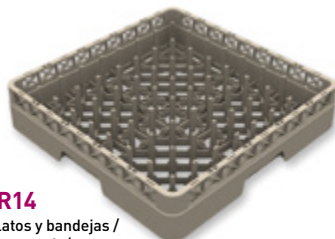

**P5003/TR14**  
Cesta para platos y bandejas / Plates and trays rack / Panier pour assiettes et plateaux / Spülkorb für Teller und Tablett

REF NOW	REF BEFORE	U
P5000	TR2	6
P5003	TR14	6

**TR33** Tapa para cestas / Rack lid / Couvercle pour panier / Spülkorbdeckel

**FLAP RACK®**



REF NOW	REF BEFORE	U
TR33	5010	6

**P5060** Cesta para almacenar cubiertos / Basket for cutlery storage / Panier pour rangement couverts / Besteckkorb

**FLAP RACK®**



REF	max. (mm)	H (mm)*	CAPACIDAD CUBIERTOS / CUTLERY STORAGE / CAPACITÉ COUVERTS / KORB FÜR BESTECKE	U
P5060	15	18	400	1
P5061	19	22	400	1
P5062	23	26	400	1

\*Altura total del conjunto  
Total set height  
Hauteur totale lot  
Gesamthöhe des Sets

Media cesta para cubiertos / Flatware basket / Demi-panier pour couverts / Spülkorbeinsatz für Besteck

**FLAP RACK®**

**P5018**

Con asa  
With handle  
Avec anse  
Mit griff

**P5019**

Sin asa  
Without handle  
Sans anse  
Ohne Griff

**P5004**

Cestillo para cubiertos  
Flatware basket  
Petit panier pour couverts  
Kleiner Spülkorbeinsatz für Besteck

REF	U
P5018	6
P5019	6
P5004	6

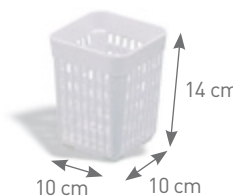
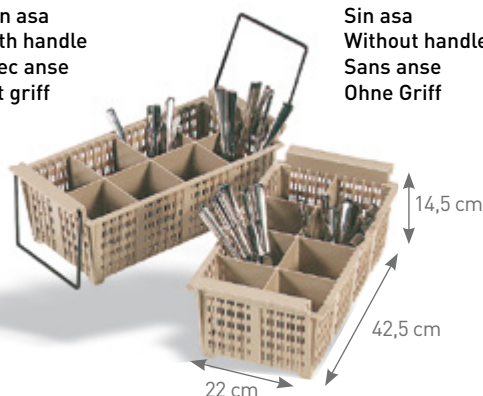



**CESTAS MEDIO TAMAÑO / HALF-SIZE RACKS /  
CASIERS DEMI-TAILLE / SPÜLKÖRBE IN HALBGRÖßE**
**HR1** Cestas para vasos medio tamaño / Half-size glass racks /  
Casiers à verres demi-taille / Gläserkorb in Halbgröße

**BASE  
Y EXTENSIONES /  
AND EXTENSIONS /  
ET RÉHAUSSES /  
UND VERGRÖßERUNGEN**
**T-VERSION**

REF NOW	U
<b>BASE</b> HR1	12
HRA	12
HRB	12
HRB1	12
HRC	12
HRC1	12
HRD	12
HRD1	12
HRF	12

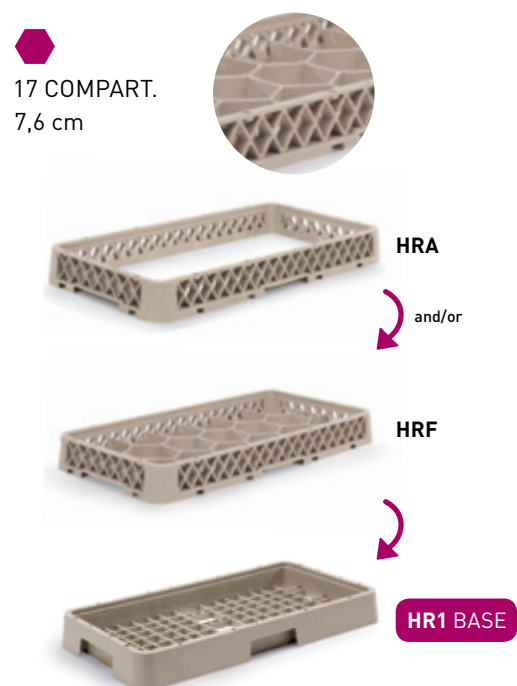
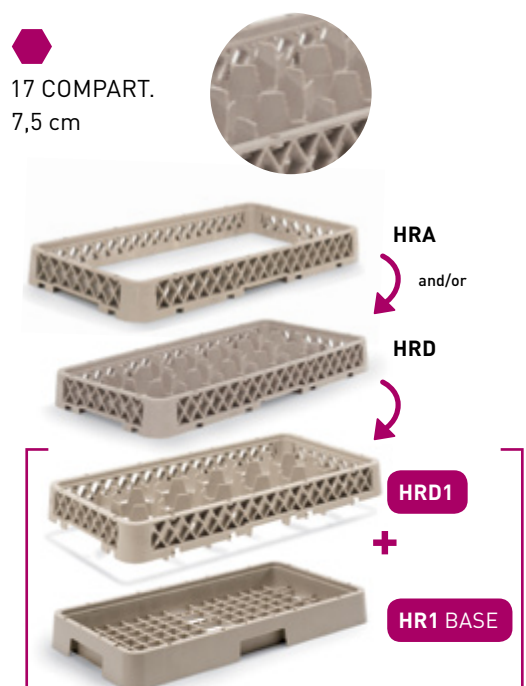
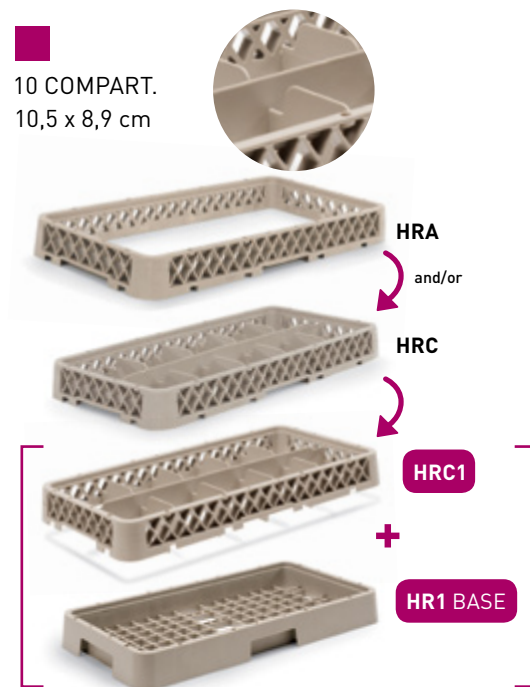
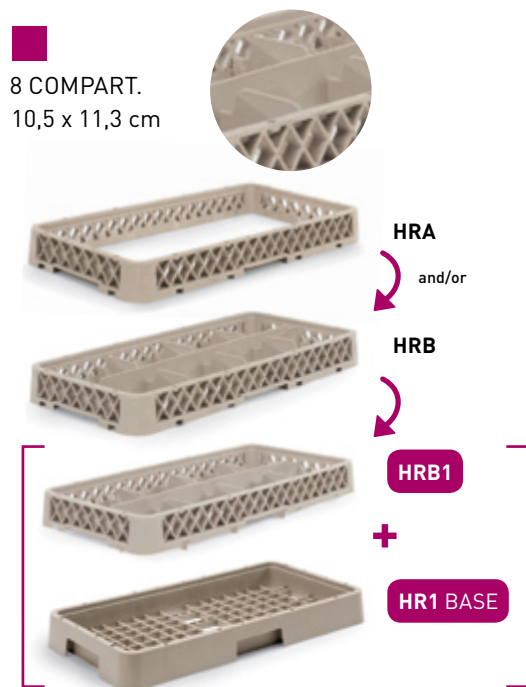



**HR1 B1** Cestas para vasos medio tamaño / Half-size glass racks / Casiers à verres demi-taille / Gläserkorb in Halbgröße

**CONJUNTOS / KITS / SETS / STÄNDERSETS**

**T-VERSION**



**B**

8 COMPART.  
10,5 x 11,3 cm



HR1 B1

**C**

10 COMPART.  
10,5 x 8,9 cm



HR1 C1CC

**D**

17 COMPART.  
7,5 cm



HR1 D1DD

**F**

17 COMPART.  
7,6 cm



HR1 F

REF	H cm		U
	INTERIOR / INSIDE / INTÉRIEURE / BESCHREIBUNG	EXTERIOR / OUTSIDE / EXTÉRIEURE / AUSSENDURCH	
HR1 B1	7,6	9,7	6
HR1 B1B	12,1	14,1	4
HR1 B1BB	16,5	18,6	2
HR1 B1BBB	20,1	23	2
HR1 C1	7,6	9,7	6
HR1 C1C	12,1	14,1	4
HR1 C1CC	16,5	18,6	2
HR1 C1CCC	20,1	23	2
HR1 D1	7,6	9,7	6
HR1 D1D	12,1	14,1	4
HR1 D1DD	16,5	18,6	2
HR1 D1DDD	20,1	23	2
HR1 F	7,6	9,7	6
HR1 FF	12,1	14,1	4
HR1 FFF	16,5	18,6	2

**HR1A** Cestas medio tamaño / Half-size racks / Casiers demi-taille / Körbe in Halbgröße



**T-VERSION**

21,3 x 45,7 cm



REF	H cm		U
	INTERIOR / INSIDE / INTÉRIEURE / BESCHREIBUNG	EXTERIOR / OUTSIDE / EXTÉRIEURE / AUSSENDURCH	
HR1 A	7,6	9,7	6
HR1 AA	12,1	14,1	4
HR1 AAA	16,5	18,6	2
HR1 AAAA	20,1	23	2

**HR2** Cestas de medio tamaño para cubiertos / Half-size flatware racks / Casiers à couverts demi-taille / Besteckkörbe in Halbgröße



**T-VERSION**

21,3 x 45,7 cm



REF	H cm		U
	INTERIOR / INSIDE / INTÉRIEURE / BESCHREIBUNG	EXTERIOR / OUTSIDE / EXTÉRIEURE / AUSSENDURCH	
HR2	3,2	5,2	12
HR2 A	7,7	9,7	6

TRANSPORTE Y ALMACENAMIENTO /  
TRANSPORT & STORAGE /  
TRANSPORT ET STOCKAGE

# FLAP RACK®

ESPAÑOL

CESTAS ESPECIALES PARA PLATOS: IDEALES PARA EL LAVADO, ALMACENAMIENTO Y TRANSPORTE DE PLATOS. PERFECTAS PARA BANQUETES, HOTELES, COLECTIVIDADES Y EMPRESAS DE ALQUILER DE MATERIAL PARA LA HOSTELERÍA. REDUCEN LAS ROTURAS DE PLATOS, MINIMIZAN EL COSTE DEL TRANSPORTE Y MANIPULACIÓN.

ENGLISH

PLATE CRATE: PERFECT DISH WASHING, STORING AND TRANSPORTING FOR BANQUETS, HOTELS, INSTITUTIONS AND CATERING EQUIPMENT RENTAL COMPANIES. THEY MINIMIZE THE PLATE BREAKAGE, LABOUR AND HANDLING COST

FRANÇAIS

CASIERS POUR ASSIETTES: IDÉALES POUR LE LAVAGE, STOCKAGE ET TRANSPORT D'ASSIETTES. PARFAITS POUR BANQUETS, HÔTELS, COLLECTIVITÉS ET SOCIÉTÉS DE LOCATION DE MATÉRIEL POUR L'HÔTELLERIE. CE TYPE DE CASIERS PERMET DE RÉDUIRE LE NOMBRE D'ASSIETTES CASSÉES AINSI QU'UNE DIMINUTION DES COÛTS DE TRANSPORT ET MANIPULATION

DEUTSCH

SPÜLKÖRBE SPEZIELL FÜR TELLER: IDEAL FÜR DIE REINIGUNG, LAGERUNG UND TRANSPORT DER TELLER. PERFEKT FÜR BANKETTS, HOTELS, CATERING UND FIRMEN, DIE GASTRONOMIEMATERIAL VERMIETEN. WENIGER ZERBROCHENE TELLER, MINIMIERUNG DER TRANSPORT- UND ABWICKLUNGSKOSTEN.

Dos modalidades /  
Two types /  
Deux modèles /  
Zwei Typen

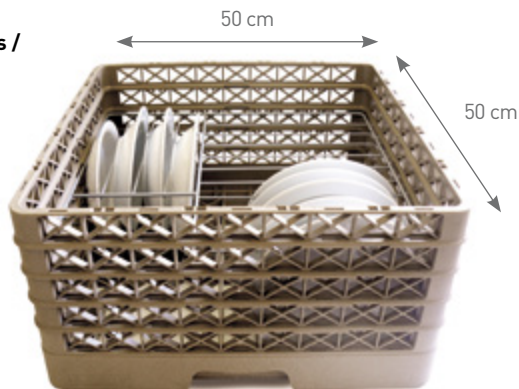

Limpieza y secado rápido.  
Faster wash and rinse.  
Propreté et séchage plus rapide.  
Schnelle Reinigung und Trocknung.



Almacenamiento y transporte más seguro e higiénico.  
More safety and hygienic storing and transporting.  
Stockage et transport plus sûr et hygiénique.  
Lagerung und Transport sicherer und hygienischer.

Nueve formatos de rejilla /  
Nine different grids /  
Neuf grilles différentes /  
Neun Gitterformate

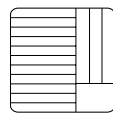

P1412-6

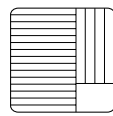

P1912-6

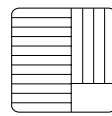

P1510-5

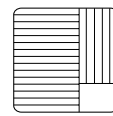

P2011-5

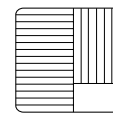

P2110-5

Mayor protección, resistencia y durabilidad.  
Extra protection, strength and durability.  
Plus grande protection, résistance et durabilité.  
Extra Schutz, Resistenz und Langlebigkeit.

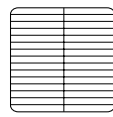

P3008-4

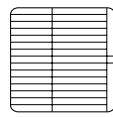

P3208-3

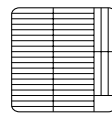

P4407-3

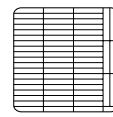

P6305-2

**Como elegir la cesta de platos adecuada:**  
debe medir el diámetro y altura del plato. Con estos datos escoger, de las 9 combinaciones posibles, aquella que se ajuste más a las medidas del plato.

**How to chose the appropriate plate crate:**  
measure the plate diameter and height. You have then to chose between the 9 different grids according to the measures you get previously.

**Comment choisir le casier pour assiettes:**  
Mesurer le diamètre et l'hauteur de l'assiette. Selon ces mesures choisir entre le 9 possibles combinaisons de grille qui s'adapte au mieux.

**Wie wählen Sie den geeigneten Tellerspülkorb:**  
Messen Sie den Diameter und die Höhe des Tellers. Mit diesen Massen wählen Sie eine von 9 verschiedenen Kombinationen aus, die sich am nächsten an die Masse der Teller anpasst.



## P1412-6

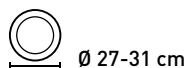

**FLAP RACK®**

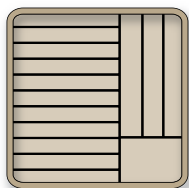

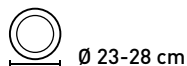

REF	 I max. (cm)	CAPACIDAD PLATOS CAPACITY PLATES CAPACITÉ ASSIETTES TELLERFASSUNGSVERMÖGEN	U
P1412-6	3,5	14	1
P1412-6 F1*	3,5	14	1

## P1510-5

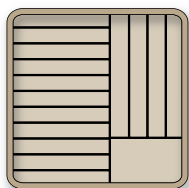

**FLAP RACK®**



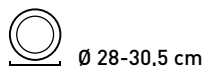

REF	 I max. (cm)	CAPACIDAD PLATOS CAPACITY PLATES CAPACITÉ ASSIETTES TELLERFASSUNGSVERMÖGEN	U
P1510-5	3,5	15	1
P1510-5 F1*	3,5	15	1

## P1912-6

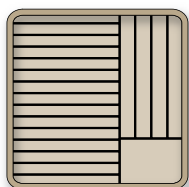

**FLAP RACK®**



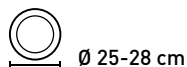

REF	 I max. (cm)	CAPACIDAD PLATOS CAPACITY PLATES CAPACITÉ ASSIETTES TELLERFASSUNGSVERMÖGEN	U
P1912-6	2,5	19	1
P1912-6 F1*	2,5	19	1

## P2011-5

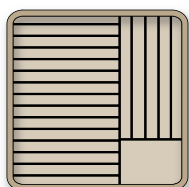

**FLAP RACK®**



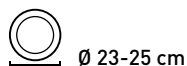

REF	 I max. (cm)	CAPACIDAD PLATOS CAPACITY PLATES CAPACITÉ ASSIETTES TELLERFASSUNGSVERMÖGEN	U
P2011-5	2,5	20	1
P2011-5 F1*	2,5	20	1

## P2110-5

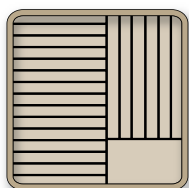

**FLAP RACK®**



REF	 I max. (cm)	CAPACIDAD PLATOS CAPACITY PLATES CAPACITÉ ASSIETTES TELLERFASSUNGSVERMÖGEN	U
P2110-5	2,5	21	1
P2110-5 F1*	2,5	21	1

## P3008-4

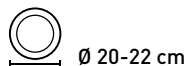

**FLAP RACK®**



REF	 I max. (cm)	CAPACIDAD PLATOS CAPACITY PLATES CAPACITÉ ASSIETTES TELLERFASSUNGSVERMÖGEN	U
P3008-4	2,5	30	1
P3008-4 F1*	2,5	30	1

- \* Cestas cerradas
- \* Closed racks
- \* Paniers fermés
- \* Geschlossene Spülkörbe

Indicar el código de color al final de la referencia.  
Indicate the colour code at the end of the item reference.  
Indiquer le code de couleur a la fin de la référence.  
Angabe des Farbcodes am Ende der Artikelnummer.

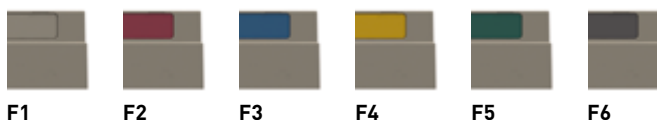

F1 F2 F3 F4 F5 F6

**FLAP RACK®**

## CESTAS PARA PLATOS / PLATE RACKS / CASIERS ASSIETTES / TELLERSPÜLKÖRBE

## P3208-3

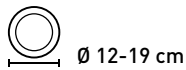

**FLAP  
RACK®**

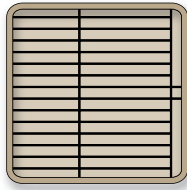

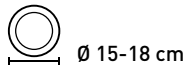

REF	 I max. (cm)	CAPACIDAD PLATOS CAPACITY PLATES CAPACITÉ ASSIETTES TELLERFASSUNGSVERMÖGEN	U
P3208-3	2,5	32	1
P3208-3 F1*	2,5	32	1

## P4407-3

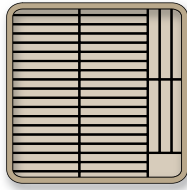

**FLAP  
RACK®**



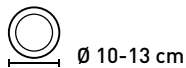

REF	 I max. (cm)	CAPACIDAD PLATOS CAPACITY PLATES CAPACITÉ ASSIETTES TELLERFASSUNGSVERMÖGEN	U
P4407-3	2	44	1
P4407-3 F1*	2	44	1

## P6305-2

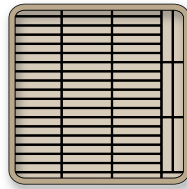

**FLAP  
RACK®**



REF	 I max. (cm)	CAPACIDAD PLATOS CAPACITY PLATES CAPACITÉ ASSIETTES TELLERFASSUNGSVERMÖGEN	U
P6305-2	2,5	63	1
P6305-2 F1*	2,5	63	1

## TR23 / TR30

Cesta para grandes bandejas / Open tray rack / Panier pour grands plateaux / Spülkorb für grosse tablets.



**T-VERSION**



TR23



TR30

REF	REF BEFORE	H cm INTERIOR / INSIDE / INTÉRIEURE / BESCHREIBUNG	H cm EXTERIOR / OUTSIDE / EXTÉRIEURE / AUSSENDURCH	U
TR23*	-	13,3	13,3	1
TR30	5030	8,3	10,2	1

\* Capacidad para tres bandejas extendidas de tamaño completo.  
Holds three full-size sheet pans.  
Contient trois tôles à biscuits.  
Fasst drei Backbleche in Standardgröße.

## TR21 / TR22

Cesta para bandejas isotérmicas, GN y platos / GN, isothermal trays and plates rack / Panier pour plateaux isothermes, GN et assiettes / Spülkorb für isothermische tablets, GN und teller



**T-VERSION**



TR21



TR22

REF	REF BEFORE	H cm INTERIOR / INSIDE / INTÉRIEURE / BESCHREIBUNG	H cm EXTERIOR / OUTSIDE / EXTÉRIEURE / AUSSENDURCH	U
TR21	-	8,3	12,1	1
TR22	5050	13,3	13,3	1

**TR21**  
10 Compartimentos.  
10 Compartments.  
10 Compartiments.  
10 Fächer.

**TR22**  
Cesta de extremo abierto.  
Open end rack.  
Casier ouvert à l'extrémité.  
Offener Korb.

- \* Cestas cerradas
- \* Closed racks
- \* Paniers fermés
- \* Geschlossene Spülkörbe

Indicar el código de color al final de la referencia.  
Indicate the colour code at the end of the item reference.  
Indiquer le code de couleur à la fin de la référence.  
Angabe des Farbcodes am Ende der Artikelnummer.



F1



F2



F3



F4



F5



F6

**FLAP  
RACK®**





SIGNATURE

Signature

SISTEMAS PARA LAVAR UTENSILIOS / WAREWASHING RACKS /  
ARTICLES DE LAVAGE / GESCHIRRWÄSCHE

OFRECE LA MÁS GRANDE SELECCIÓN DE CESTAS PARA COPAS Y VASOS, VAJILLAS Y CUBIERTOS  
OFFERS THE LARGEST SELECTION OF RACKS FOR GLASSWARE, DINNERWARE AND FLATWARE  
OFFRE LA PLUS VASTE SÉLECTION DE CASIERS DE LAVAGE DE VERRES, ASSIETTES ET COUVERTS  
BIETET DIE GROSSTE AUSWAHL VON SPULKORBEN FÜR GLASER, ESSGESCHIRR UND BESTECKE AN



Disponible en azul cobalto, para otros colores, consultar.

Available in Royal blue color. For other colors, please consult.

Disponible en Bleu. Pour d'autres couleurs, veuillez consulter.

Erhältlich in Königsblau. Für andere, bitte konsultieren.

El diseño de esquinas con clavijas permite apilar de forma segura.

**Peg corner design** provides secure stacking.

**Le concept a pointes aux angles** permet un empilage sûr.

**Stiftecken-Design** gewährleistet ein sicheres Stapeln



**El exclusivo diseño de cesta**

usa tornillos de acero inoxidable y una amplia variedad de montantes y divisores intercambiables para cientos de configuraciones personalizadas.

**Unique rack design**

uses stainless screws and a variety of interchangeable risers and dividers for hundreds of custom configurations.

**Le concept de casier unique**

utilise des vis inox et toute une variété de montants et partitions interchangeables pour des centaines de configurations sur mesure.

**Einmaliges Regal design**

basiert auf Edelstahlschrauben und einer Vielfalt an austauschbaren Standern und Trenneinsätzen für Hunderte von Spezialkonfigurationen.

**El diseño abierto**

facilita una mejor acción de lavado, enjuague y agiliza el secado.

**Open design promotes better**

washing and rinsing, and faster drying.

**La conception ouverte des casiers**

stimule l'action de lavage et produit un rinçage complet et un séchage plus rapide.

**Offenes Design**

für ein wirkungsvolleres Waschen und Spülen und ein schnelleres Trocknen.

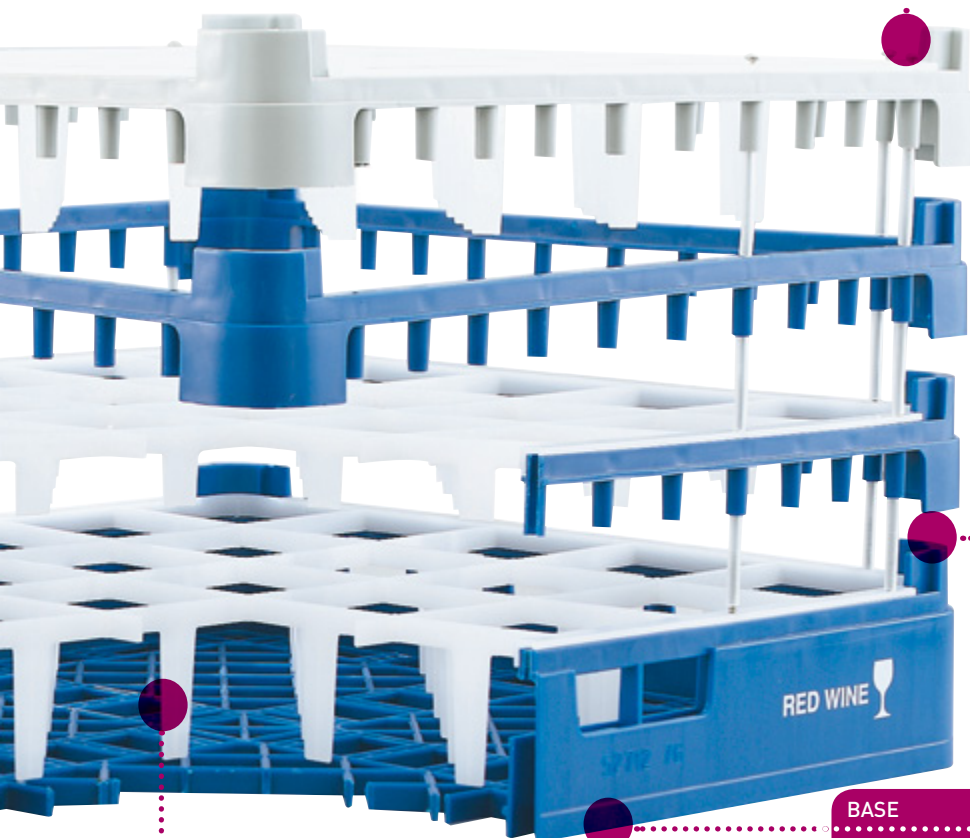

BASE

500 x 500 mm  
h 71 mm

**El divisor sólido en el fondo protege**

el borde de las copas contra picaduras.

Diseñadas para una variedad de copas de martini y margarita.

**Solid bottom divider protects**

the rim of the glasses from chipping.

Designed for a variety of martini and margarita glasses.

**Le fond plein empêche le bord**

des verres de s'ébrécher. Conçu pour une

variété de verres à martini et à margarita.

**Durchgehende Bodenteilung schützt**

den Glasrand vor Beschädigungen. Für eine Vielfalt

von Martini- und Margarita-Glasern entworfen.

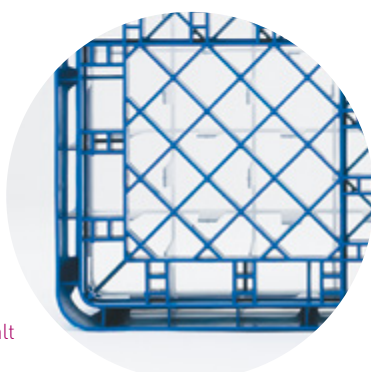

**Los carriles de cuatro direcciones**

en todas las cestas de tamaño completo permiten cargar rápidamente la máquina de platos en cualquier dirección.

**Four-way tracking**

on all full-size racks allows fast dish machine loading in either direction.

**Les rails dans quatre sens**

sur tous les casiers grande taille permettent un chargement rapide dans le lave-vaisselle sans se préoccuper du sens.

**Sicheres Aufeinanderstellen auf allen vier Seiten**

bei allen Korben in Standardgröße ermöglicht ein schnelles Laden der Geschirrspülmaschine in beiden Richtungen.





**EN CESTAS DE 20 Y 30 COMPARTIMENTOS /  
DESIGN ON THE 20 AND 30 COMPARTMENT RACKS /  
SUR LES CASIERS À 20 ET 30 COMPARTIMENTS /  
DESIGN BEI SPÜLKÖRBE MIT 20 UND 30 FÄCHERN**



ESPAÑOL

PROPORCIONA UN AGARRE NATURAL QUE ES EL MEJOR DE LA INDUSTRIA PARA EL RETIRO RAPIDO Y EFICIENTE DE VASOS Y COPAS. BRINDAN MAYOR CAPACIDAD QUE LAS CESTAS TRADICIONALES. GRACIAS A SU DISEÑO ABIERTO, LOS DIVISORES DE COMPARTIMIENTOS ESTRATEGICAMENTE SITUADOS PROTEGEN LA CRISTALERIA Y SON IDEALES PARA MAXIMIZAR LA EFICIENCIA DE LA LIMPIEZA.

ENGLISH

PROVIDES A NATURAL GRIP WHICH IS THE BEST IN THE INDUSTRY FOR FAST, EFFICIENT REMOVAL OF GLASSWARE. PROVIDE EXPANDED CAPACITY OVER THE TRADITIONAL RACK OPTIONS. STRATEGICALLY LOCATED COMPARTMENT DIVIDERS OFFER PREMIUM GLASS PROTECTION WHILE PROVIDING THE OPEN DESIGN — IDEAL FOR MAXIMIZING CLEANING PERFORMANCE.

FRANÇAIS

PROCURE UNE PRISE NATURELLE - LA MEILLEURE DE L'INDUSTRIE POUR UN RETRAIT RAPIDE ET EFFICACE DES VERRES DES ASIERS. CAPACITÉ SUPÉRIEURE AUX CASIERS TRADITIONNELS. LES CLOISONS DES COMPARTIMENTS PLACÉS EN DES POINTS STRATÉGIQUES OFFRENT UNE PROTECTION EXCEPTIONNELLE AUX VERRES TOUT EN MAINTENANT UN CONCEPT OUVERT — IDÉAL POUR MAXIMISER LA PERFORMANCE DE NETTOYAGE.

DEUTSCH

DESIGN ERMOGLICHT EINEN NATURLICHEN GRIFF, DER BESSER ALS JEDES KONKURRENZPRODUKT DAS SCHNELLE, EFFIZIENTE HERAUSNEHMEN VON GLASERN AUS DEM REGAL GEWAHRLEISTET. BIETEN GROSSERE AUFNAHMEFAHIGKEIT ALS HERKOMMLICHE SPÜLKORBOPTIONEN. STRATEGISCH ANGEORDNETE FACHTRENNWANDE ERMOGLICHEN EINEN OPTIMALEN SCHUTZ DER GLASER IN EINEM OFFENEN DESIGN – IDEAL FÜR EINE OPTIMALE REINIGUNGSLEISTUNG.

*Signature*

 Ø max. 149 mm

9 COMPART.



52763

REF	H cm	 max. cm	U
52726	10,5	7,1	6
52760	12,4	7,7	5
52727	14,3	11	4
52761	16,2	11,6	4
52728	17,8	14,4	3
52762	19,7	15,3	3
52730	21,6	18,1	3
52763	23,5	18,9	2
52729	25,1	21,6	2
52764	26,8	22,4	2
52731	28,7	25,2	2
52765	30,8	26,2	2
52736	32,4	28,9	2

Disponible en azul cobalto, para otros colores, consultar.  
Available in Royal blue color. For other colors, please consult.  
Disponible en Bleu. Pour d'autres couleurs, veuillez consulter.  
Erhältlich in Königsblau. Für andere, bitte konsultieren.

## SIGNATURE

Signature

 Ø max. 111 mm

16 COMPART.



52720

REF	H cm	 max. cm	U
52694	10,5	7,1	6
52766	12,4	7,7	5
52718	14,3	11	4
52767	16,2	11,6	4
52719	17,8	14,4	3
52768	19,7	15,3	3
52720	21,6	18,1	3
52769	23,5	18,9	2
52721	25,1	21,6	2
52770	26,8	22,4	2
52732	28,7	25,2	2
52771	30,8	26,2	2
52737	32,4	28,9	2

Disponible en azul cobalto, para otros colores, consultar.  
Available in Royal blue color. For other colors, please consult.  
Disponible en Bleu. Pour d'autres couleurs, veuillez consulter.  
Erhältlich in Königsblau. Für andere, bitte konsultieren.

Signature

 Ø max. 100 mm

20 COMPART.



52757

REF	H cm	 max. cm	U
52691	10,5	7,1	6
52692	12,4	7,7	5
52693	14,3	11	4
52702	16,2	11,6	4
52703	17,8	14,4	3
52704	19,7	15,3	3
52706	21,6	18,1	3
52707	23,5	18,9	2
52708	25,1	21,6	2
52709	26,8	22,4	2
52754	28,7	25,2	2
52755	30,8	26,2	2
52757	32,4	28,9	2

Disponible en azul cobalto, para otros colores, consultar.  
Available in Royal blue color. For other colors, please consult.  
Disponible en Bleu. Pour d'autres couleurs, veuillez consulter.  
Erhältlich in Königsblau. Für andere, bitte konsultieren.

Signature

 Ø max. 89 mm

25 COMPART.



52712

REF	H cm	 max. cm	U
52684	10,5	7,1	6
52772	12,4	7,7	5
52710	14,3	11	4
52773	16,2	11,6	4
52711	17,8	14,4	3
52774	19,7	15,3	3
52712	21,6	18,1	3
52775	23,5	18,9	2
52713	25,1	21,6	2
52776	26,8	22,4	2
52733	28,7	25,2	2
52777	30,8	26,2	2
52738	32,4	28,9	2

Disponible en azul cobalto, para otros colores, consultar.  
Available in Royal blue color. For other colors, please consult.  
Disponible en Bleu. Pour d'autres couleurs, veuillez consulter.  
Erhältlich in Königsblau. Für andere, bitte konsultieren.



Signature

 Ø max. 111 mm

30 COMPART.



52812

REF	H cm	 max. cm	U
52790	10,5	7,1	6
52811	12,4	7,7	5
52812	14,3	11	4
52813	16,2	11,6	4
52816	17,8	14,4	3
52817	19,7	15,3	3
52832	21,6	18,1	3
52844	23,5	18,9	2
52845	25,1	21,6	2
52846	26,8	22,4	2
52847	28,7	25,2	2
52848	30,8	26,2	2
52849	32,4	28,9	2

Disponible en azul cobalto, para otros colores, consultar.  
Available in Royal blue color. For other colors, please consult.  
Disponible en Bleu. Pour d'autres couleurs, veuillez consulter.  
Erhältlich in Königsblau. Für andere, bitte konsultieren.

Signature

 Ø max. 73 mm

36 COMPART.



52715

REF	H cm	 max. cm	U
52689	10,5	7,1	6
52778	12,4	7,7	5
52714	14,3	11	4
52779	16,2	11,6	4
52715	17,8	14,4	3
52780	19,7	15,3	3
52716	21,6	18,1	3
52781	23,5	18,9	2
52717	25,1	21,6	2
52782	26,8	22,4	2
52734	28,7	25,2	2
52783	30,8	26,2	2
52739	32,4	28,9	2

Disponible en azul cobalto, para otros colores, consultar.  
Available in Royal blue color. For other colors, please consult.  
Disponible en Bleu. Pour d'autres couleurs, veuillez consulter.  
Erhältlich in Königsblau. Für andere, bitte konsultieren.

Signature

 Ø max. 62 mm

49 COMPART.



52784

REF	H cm	 max. cm	U
52699	10,5	7,1	6
52784	12,4	7,7	5
52722	14,3	11	4
52785	16,2	11,6	4
52723	17,8	14,4	3
52786	19,7	15,3	3
52724	21,6	18,1	3
52787	23,5	18,9	2
52725	25,1	21,6	2
52788	26,8	22,4	2
52735	28,7	25,2	2
52789	30,8	26,2	2
52740	32,4	28,9	2

Disponible en azul cobalto, para otros colores, consultar.  
Available in Royal blue color. For other colors, please consult.  
Disponible en Bleu. Pour d'autres couleurs, veuillez consulter.  
Erhältlich in Königsblau. Für andere, bitte konsultieren.

## SIGNATURE

**52670** Cesta universal / Open rack / Panier universel / Universalspülkorb

Signature



52696

REF	H cm	U
52670	10,5	6
52696	12,4	5
52680	14	4
52681	17,5	3
52682	20,8	3
52683	24,3	2

Disponible en azul cobalto, para otros colores, consultar.  
Available in Royal blue color. For other colors, please consult.  
Disponible en Bleu. Pour d'autres couleurs, veuillez consulter.  
Erhältlich in Königsblau. Für andere, bitte konsultieren.

**52678** Cesta para grandes bandejas / Open tray rack / Panier pour grands plateaux / Spülkorb für grosse Tablettis

Signature



REF	H cm	U
52678	9,5	6

Disponible en azul cobalto, para otros colores, consultar.  
Available in Royal blue color. For other colors, please consult.  
Disponible en Bleu. Pour d'autres couleurs, veuillez consulter.  
Erhältlich in Königsblau. Für andere, bitte konsultieren.

**52695** Cesta para platos / Plate racks / Casiers assiettes / Tellerspülkörbe

Signature



52695

REF	H cm	U
52695	12,4	5
52672	9,5	6

Disponible en azul cobalto, para otros colores, consultar.  
Available in Royal blue color. For other colors, please consult.  
Disponible en Bleu. Pour d'autres couleurs, veuillez consulter.  
Erhältlich in Königsblau. Für andere, bitte konsultieren.

**52671** Cesta para cubiertos / Cutlery baskets / Panier pour couverts / Körbe für Besteck

Signature



REF	H cm	U
52671	10,5	6

Scan me



Click me

GUIA DE SELECCIÓN DE CESTAS PARA VAJILLA /  
DISHWASHER RACKS SELECTION GUIDE /  
GUIDE DE SÉLECTION CASIERS À VAISSELLE /  
AUSWAHLÜBERSICHT SPÜLMASCHINENKÖRBE



GUÍA DE SELECCIÓN PARA BASES Y EXTENSIONES /  
 REFERENCE GUIDE FOR BASES AND EXTENSIONS /  
 GUIDE DE SELECTION POUR BASES ET EXTENTIONS /  
 AUSWAHLÜBERSICHT FÜR DIE BASIS UND VERGRÖSSERUNGEN

ALTURA DE LAS CESTAS DE TAMAÑO COMPLETO /  
 HEIGHT OF FULL-SIZE RACKS /  
 HAUTEUR DES CASIERS GRANDE TAILLE /  
 SPÜLKORB-HÖHE (HALBGRÖSSE)

ALTURA DE LAS CESTAS DE MEDIO TAMAÑO /  
 HEIGHT OF HALF-SIZE RACKS /  
 HAUTEUR DES CASIERS DEMI-TAILLE /  
 SPÜLKORB-HÖHE (STANDARDGRÖSSE)

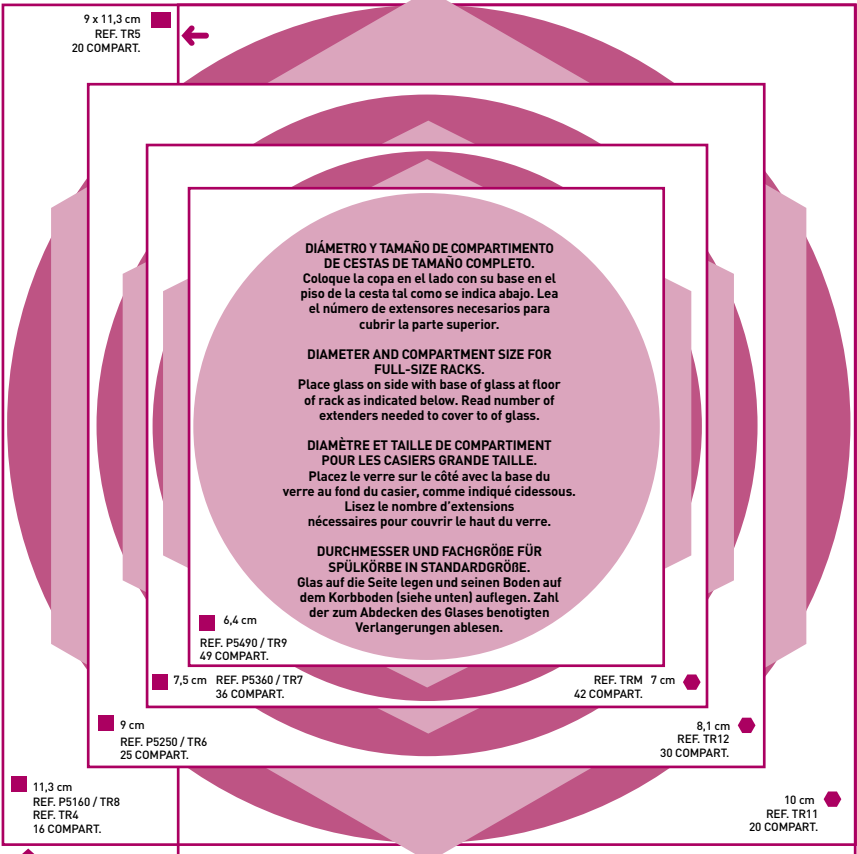

Coloque la base de la copa aquí.  
Place base of glass here.  
Placez ici la base du verre.  
Glasboden hier anlegen.

PISO DE LA CESTA  
FLOOR OF RACK  
FOND DU CASIER  
KORBODEN

Coloque la base de la copa aquí.  
Place base of glass here.  
Placez ici la base du verre.  
Glasboden hier anlegen.

CARROS DE SERVICIO EN MADERA / WOODEN SERVING TROLLEYS / CHARIOTS DE SERVICE EN BOIS / SERVIERWAGEN AUS HOLZ

# CUBIC®

## COLD

CARRO BUFFET CON POSIBILIDAD DE CONVERTIR EL CARRO EXPOSITOR EN MESA DE PRESENTACIÓN / BUFFET TROLLEY WITH POSSIBLE TRANSFORMATION FROM AN EXPOSITOR TROLLEY TO A PRESENTATION TABLE / CHARIOT BUFFET AVEC POSSIBILITÉ DE CONVERTIR LE CHARIOT D'EXPOSITION EN UNE TABLE DE PRÉSENTATION / BUFFETSERVIERWAGEN MIT DER MÖGLICHKEIT DIESEN IN EINEN PRÄSENTATIONSTISCH UMZUWANDELN

**P90490** Carro buffet negro 4 GN 1/1 / Black buffet trolley for 4 1/1 GN inserts / Chariot buffet noir pour 4 bacs GN 1/1 / Schwarzer Buffetservierwagen 4 GN 1/1

**MADERA CON TRATAMIENTO HIDRÓFUGO ESPECIAL, DE FÁCIL LIMPIEZA /**

WOOD WITH SPECIAL WATERPROOF TREATMENT, EASY TO CLEAN /

BOIS AVEC UN TRAITEMENT HYDROFUGE SPÉCIAL, FACILE À NETTOYER /

HOLZ MIT SPEZIELLER WASSERABWEISENDER BEHANDLUNG, EINFACH ZU REINIGEN

**ADAPTADO A MEDIDAS GASTRONORM /**

SUITABLE FOR GASTRONORM SIZES /

ADAPTÉ AUX MESURES GASTRONORME /

GEEIGNET FÜR GASTRONORMGRÖSSEN

**EXCLUSIVE**

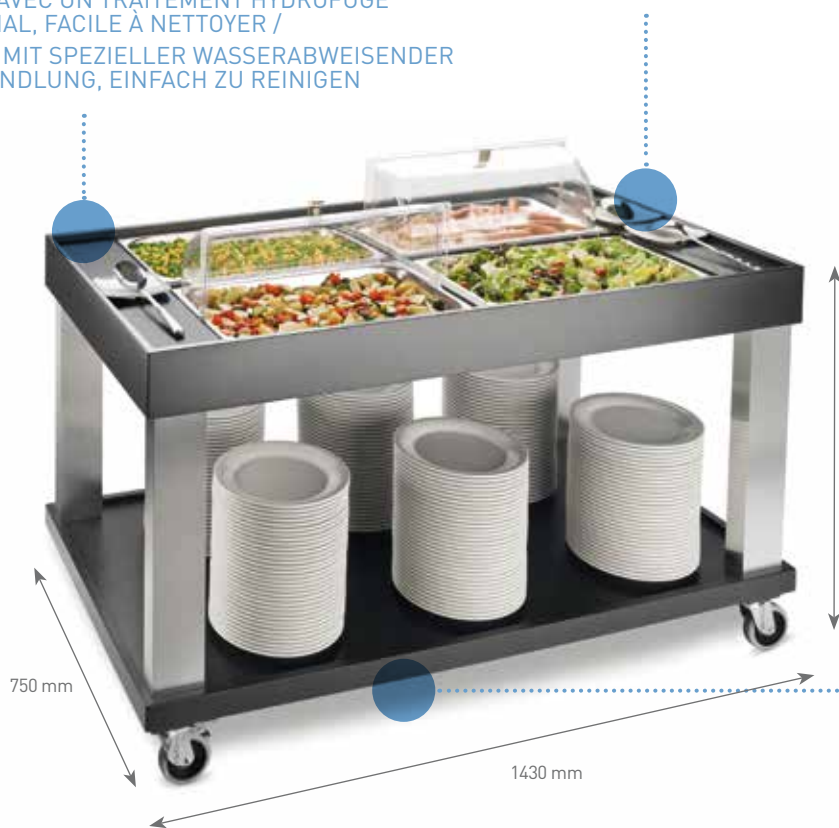

\*Dos tapas incluidas en precio /  
\*Two cover are included on the price /  
\*Deux tablettes comprises dans le prix /  
\*Zwei Deckel im Preis inklusive

REF. P90.492

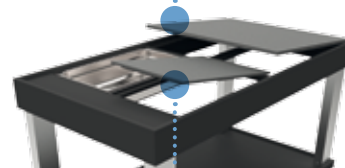

900 mm

Tapa individual encaje GN 1/1 no incluida en precio /  
Cover for 1/1 GN insert not included on the price /  
Tablette de bac GN 1/1 non comprise dans le prix /  
Individueller Deckel passend zu GN 1/1 nicht im Preis inklusive

REF. P90493

Barra refuerzo nivel inferior /  
Reinforcement bar /  
Barre de renforcement /  
Bewehrungsstab

**ELEGANTE COMBINACIÓN DE MADERA Y ALUMINIO /**

OUTSTANDING COMBINATION OF WOOD AND ALUMINIUM /

COMBINAISON ÉLÉGANTE EN BOIS ET EN ALUMINIUM /

ELEGANTE KOMBINATION AUS HOLZ UND ALUMINIUM

**RUEDAS GIRATORIAS E INSONORAS DE Ø 125 mm, CON FRENO /**

SOUNDPROOF AND REVOLVING CASTORS Ø 125 mm, WITH BRAKES /

ROULETTES INSONORES ET PIVOTANTES DE Ø 125 mm, AVEC FREINS /

BEWEGLICHE UND GERÄUSCHLOSE RÄDER Ø 125 mm, MIT BREMSEN

**SE SUMINISTRAN DESMONTADOS ENTRE 3 A 5 MINUTOS DE MONTAJE /**

DELIVERED FLATPACKED BETWEEN 3 TO 5 MINUTES ASSEMBLY /

LIVRÉS DÉMONTÉS

ENTRE 3 ET 5 MINUTES DE MONTAGE /

LIEFERUNG UNMONTIERT RÄDER

MONTAGE ZWISCHEN 3 UND 5 MINUTEN



REF	TIPO / TYPE	U
P90.490*	4 X GN 1/1	1
P90.492	TAPA / COVER / TABLETTE / DECKEL	1
P90.493	TAPA / COVER / TABLETTE / DECKEL 1/1	1



# WARM

**CARRO BUFFET ESPECIAL PARA TODO TIPO DE COMIDAS, FRÍAS, SEMI-FRÍAS O CALIENTES /  
BUFFET TROLLEY SUITABLE FOR ALL KINDS OF FOOD, COLD, SEMI-COLD OR HOT /  
CHARIOT BUFFET SPÉCIAL POUR TOUT TYPE DE NOURRITURES, FROIDES, SEMI-FROIDES OU CHAUDES /  
BUFFETWAGEN GEIGNET FÜR ALLE MAHLZEITEN, KALT, WARM ODER GEMISCHT**

**P90495** Carro buffet 4 1/1 GN caliente / Buffet trolley 4 1/1 GN hot /  
Chariot buffet 4 1/1 GN chaud / Buffetwagen (warm) 4 1/1 GN

**SUPERFÍCIE SUPERIOR DE ABEDÚL FINLANDÉS DE ALTÍSIMA RESISTENCIA A AMBIENTES HÚMEDOS E INCLUSO A LA INTEMPERIE/**

UPPER SURFACE OF FINNISH BIRCH, EXTREMELY RESISTANT TO HUMID ENVIRONMENTS AND EVEN OUTDOORS /

SURFACE SUPÉRIEURE EN BOULEAU FINLANDAIS, HAUTEMENT RÉSTANTE AUX ENVIRONNEMENTS HUMIDES ET MÊME AUX INTEMPÉRIES /

OBERFLÄCHE FINNISCHER BIRKE, EXTREM WIDERSTANDSFÄHIG GEGEN FEUCHTE UND SOGAR IM FREIEN

**ADAPTADO A MEDIDAS GASTRONORM / SUITABLE FOR GASTRONORM SIZES / ADAPTÉ AUX MESURES GASTRONORME / GEEIGNET FÜR GASTRONORMGRÖSSEN**

**EXCLUSIVE**

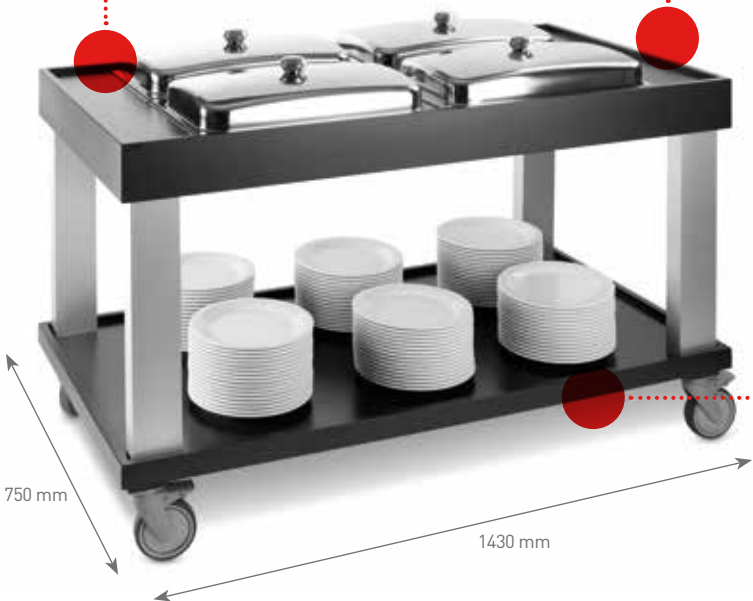

875 mm Opcional: se pueden adaptar placas de inducción /  
Optional: can be adapted for induction plates /  
Optionnel : on peut adapter des plaques à induction /  
Zusatzausstattung: Passende Induktionsplatten verfügbar

Barra refuerzo nivel inferior /  
Reinforcement bar /  
Barre de renforcement /  
Bewehrungsstab

**\*SE ENTREGA CON: 2 ELEMENTOS ELÉCTRICOS REF. 9500 + 4 CUBETAS GN 1/1 100 MM CON SOPORTE ELEMENTO ELÉCTRICO + 4 TAPAS GN 1/1 + 2 TAPAS MADERA /**

**\*COMES WITH: 2 ELECTRICAL ELEMENTS REF. 9500 + 4 TRAYS GN 1/1 100 MM WITH SUPPORT ELECTRIC ELEMENT + 4 COVERS GN 1/1 + 2 WOODEN COVERS /**

**\*FOURNI AVEC : 2 ÉLÉMENTS ÉLECTRIQUES RÉF. 9500 + 4 BAÇS GN 1/1 100 MM AVEC SUPPORT ÉLÉMENT ÉLECTRIQUE + 4 COUVERCLES GN 1/1 + 2 COUVERCLES BOIS /**

**\*IM LIEFERUMFANG ENTHALTEN: 2 ELEKTRISCHE ELEMENTE REF. 9500 + 4 SPEISEBEHÄLTER GN 1/1 100 MM MIT ELEKTRISCHEM ANSCHLUSS + 4 DECKEL GN 1/1 + 2 DECKEL, HOLZ**

**INSTALACIÓN ELÉCTRICA PREPARADA PARA 4 ELEMENTOS ELÉCTRICOS /**

ELECTRICAL SYSTEM DESIGNED FOR 4 ELECTRICAL ELEMENTS /

INSTALLATION ÉLECTRIQUE PRÉVUE POUR 4 ÉLÉMENTS

ÉLECTRIQUES / ELEKTRISCHE INSTALLATION VORBEREITET FÜR VIER ELEKTRISCHE ELEMENTE

**LATERAL CON SOPORTE ESPECIAL PARA TAPAS CHAFING DISH /**

SIDE WITH SPECIAL SUPPORT FOR CHAFING DISH COVERS /

PARTIE LATÉRALE AVEC SUPPORT SPÉCIAL POUR COUVERCLES CHAFING DISH /

SEITENELEMENTE MIT HALTERUNG FÜR DECKEL DES CHAFING-DISH



REF	TIPO / TYPE	U
P90.495*	4 x GN 1/1	1
P90.492	TAPA / COVER / TABLETTE / DECKEL	1
P90.493	TAPA / COVER / TABLETTE / DECKEL 1/1	1

CARROS DE SERVICIO EN MADERA / WOODEN SERVING TROLLEYS /  
CHARIOTS DE SERVICE EN BOIS / SERVIERWAGEN AUS HOLZ

**TREND  
CUBIC®**

Carro madera-aluminio 2 estanterías / Wooden-aluminium trolley 2 shelves /  
Chariot en bois-aluminium 2 plateaux / Servierwagen Holz-Aluminium mit 2 Regalen

REF	COLOUR	U
P80.210	BLANCO / WHITE / BLANC / WEISS	1
P80.220	NEGRO / BLACK / NOIR / SCHWARZ	1

Ref. 80220



PIES EN ALUMINIO ANODIZADO /  
ANODISED ALUMINIUM FEET /  
PIEDS EN ALUMINIUM ANODISÉ /  
FÜSSE AUS ELOXIERTEM ALUMINIUM

RUEDAS GIRATORIAS E INSONORAS DE Ø 100 mm, DOS CON FRENO /  
SOUNDPROOF AND REVOLVING CASTORS Ø 100 mm, TWO WITH BRAKES /  
ROULETTES INSONORES ET PIVOTANTES DE Ø 100 mm, DEUX AVEC FREINS /  
BEWEGLICHE UND GRÄUSCHLOSE RÄDER Ø 100 mm, ZWEI MIT BREMSEN

Ref. 80210



MADERA CON TRATAMIENTO HIDRÓFUGO /  
WOOD WITH WATERPROOF TREATMENT /  
BOIS AVEC UN TRAITEMENT HYDROFUGE /  
HOLZ MIT WASSERABWEISENDER BEHANDLUNG

SE SUMINISTRAN DESMONTADOS /  
DELIVERED FLATPACKED /  
LIVRÉS DÉMONTÉS /  
LIEFERUNG UNMONTIERT

Entre 3 a 5 minutos de montaje.  
Between 3 to 5 minutes assembly.  
Entre 3 et 5 minutes de montage.  
Montage zwischen 3 und 5 Minuten.

**P80219** Gueridón o carro auxiliar madera / Wooden gueridon trolley /  
Chariot guéridon en bois / Abräum- oder Hilfswagen aus Holz

**CUBIC®**

REF	COLOUR	U
P80.219	NEGRO / BLACK / NOIR / SCHWARZ	1

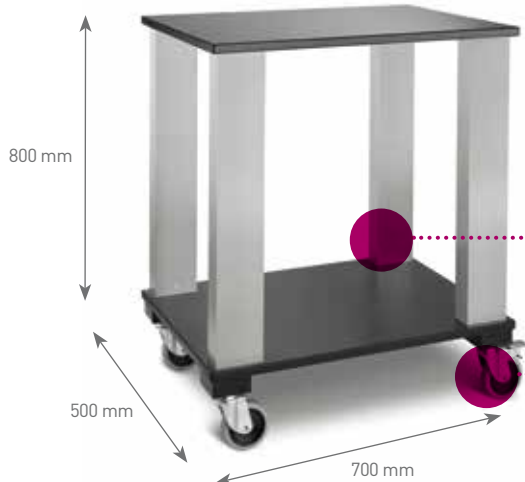

Madera con tratamiento hidrófugo.  
Wood with waterproof treatment.  
Bois avec un traitement hydrofuge.  
Holz mit wasserabweisender Behandlung.

Se suministran desmontados. Entre 3 a 5 minutos de montaje.  
Delivered flatpacked. Between 3 to 5 minutes assembly.  
Livrés démontés. Entre 3 et 5 minutes de montage.  
Lieferung unmontiert. Montage zwischen 3 und 5 Minuten.

PIES EN ALUMINIO ANODIZADO /  
ANODISED ALUMINIUM FEET /  
PIEDS EN ALUMINIUM ANODISÉ /  
FÜSSE AUS ELOXIERTEM ALUMINIUM

RUEDAS GIRATORIAS E INSONORAS DE Ø 100 mm, DOS CON FRENO /  
SOUNDPROOF AND REVOLVING CASTORS Ø 100 mm, TWO WITH BRAKES /  
ROULETTES INSONORES ET PIVOTANTES DE Ø 100 mm, DEUX AVEC FREINS /  
BEWEGLICHE UND GRÄUSCHLOSE RÄDER Ø 100 mm, ZWEI MIT BREMSEN

**P90813** Carro porta-cubiertos / Cutlery dispenser trolley / Chariot porte couverts / Transportwagen für besteck

**EXCLUSIVE**

**CUBIC®**



REF	U
P90.813	1



No incluye porta-cubiertos, cubetas GN, platos ni bandejas / Trays, dishes, GN containers and cutlery dispenser not included / Ramasse-couverts, bacs GN, assiettes, et plateaux pas compris / Besteckbehälter, GN behälter, platten und tablett nicht inklusive

**P90814** Porta-cubiertos / Cutlery bin / Ramasse-couverts / Besteckbehälter

**EXCLUSIVE**

**CUBIC®**



4 x 1/3 GN  
H max. 100 mm

REF	mm	U
P90.814	710 x 335 x 155	1



No incluye cubetas GN / GN containers not included / Bacs GN non inclus / GN behälter nicht inklusive

**P80216** Carro gueridón melamina roble / Oak melamine gueridon trolley / Chariot gueridon mélamine roure / Servierwagen aus eiche melamine

**EXCLUSIVE**

**CUBIC®**



REF	U
P80.216	1

Se suministran desmontados. Entre 3 a 5 minutos de montaje / Delivered flatpacked. Between 3 to 5 minutes assembly / Livrés démontés. Entre 3 et 5 minutes de montage / Lieferung unmontiert räder. Montage zwischen 3 und 5 minuten

PIÉS EN ALUMINIO ANODIZADO NEGRO / BLACK ANODISED ALUMINIUM FEET / PIEDS EN ALUMINIUM ANODISÉ NOIR / MIT SCHWARZ, ELOXIERTEN ALUMINIUMSTÄNDERN

CON CHAPADO DE MELAMINA IMITACIÓN MADERA / WITH MELAMINE IMITATION WOOD VENEER / À REVÊTEMENT MÉLAMINÉ IMITATION BOIS / MIT MELAMINBESCHICHTUNG IN HOLZIMITATION

CARROS DE SERVICIO ALUMINIO / ALUMINIUM SERVING TROLLEYS / CHARIOT DE SERVICE EN ALUMINIUM / SERVICEWAGEN AUS ALUMINIUM

**P8090** Carro aluminio desembarace / Aluminium clearing trolley / Chariot débarrassage en aluminium / Aluminium Abräumwagen

**EXCLUSIVE**



REF	U
P80.900	1

Medidas de estantes adaptables a cubetas GN 1/1 y cestas FLAP-RACK® (500 x 500 mm). Carga máxima: total 150 Kg y con un máximo de 75 Kg por estante.

Racks adjustable to 1/1 GN containers and FLAP-RACK® (500 x 500 mm). Maximum load: 150 Kg and max. per level 75 Kg.

Clayettes adaptables à des bacs GN 1/1 et à casiers à vaisselle FLAP-RACK® (500 x 500 mm). Charge maximale: total 150 Kg et 75 Kg par niveau.

Masse der regale passend für GN behälter 1/1 und FLAP-RACK® spülkörbe (500 x 500 mm). Maximale tragkraft: total 150 Kg und maximal 75 Kg pro regal.

**P6411** Carro de servicio / Trolley / Chariot de service / Servierwagen



REF	DIM. ESTANTE / SHELF DIMENTION / DIM. NIVEAU / REGALGRÖSSE mm	U
P641.100	780 x 485	1

Carga máxima 120 kgs  
Maximum weight load 120 kgs  
Charge maximale 120 kgs  
Maximale Tragkraft 120 kg

Soportes de aluminio  
Aluminium supports  
Supports en aluminium  
Aluminiumständer

**P642 / P643** Contenedor para cubiertos / Silverware container / Conteneur pour couverts / Besteckkasten  
Contenedor para desperdicios / Refuse container / Conteneur pour déchets / Abfalleimer



REF	cm	Lts	U
P642.000	32 x 19,5 x 16,5	9,00	1
P643.000	33,5 x 23 x 56	80,00	1

**P640** Conjunto carro / Set trolley / Ensemble chariot / Servierwageneset



REF	DIM. ESTANTE / SHELF DIMENTION / DIM. NIVEAU / REGALGRÖSSE mm	U
P640.000	780 x 485	1



CARRO SERVICIO ACERO INOXIDABLE / ST/STEEL SERVING TROLLEY / CHARIOT SERVICE EN ACIER INOXYDABLE / SERVIERWAGEN AUS EDELSTAHL

ESPAÑOL

ESTRUCTURA TUBULAR EN ACERO INOXIDABLE DE 1,5 mm ESPESOR.  
ESTANTES INSONORIZADOS Y SOLDADOS A LA ESTRUCTURA TUBULAR (VERSIÓN CARROS MONTADOS).  
RUEDAS GIRATORIAS INSONORAS DE ACERO Ø 125 mm. DOS DE ELLAS CON FRENO.  
CARGA MÁXIMA: TOTAL 250 KG CON UN MÁXIMO DE 80 KG POR ESTANTE.

ENGLISH

1,5 mm THICK ST/STEEL TUBULAR FRAME.  
SOUNDPROOF MOULDED SHELVES WELDED ON FRAME. (ONLY FOR ASSEMBLED TROLLEYS).  
SOUNDPROOF REVOLVING CASTORS Ø 125 mm. TWO OF THEM WITH BRAKES.  
MAXIMUM LOAD: 250 KG AND MAX. PER LEVEL 80 KG.

FRANÇAIS

STRUCTURE TUBULAIRE EN ACIER INOXYDABLE 1,5 mm ÉPAISSEUR.  
PLATEAUX INSONORISÉS SOUDÉS À LA STRUCTURE TUBULAIRE. (VERSION CHARIOTS MONTÉS).  
ROULETTES GIRATOIRES INSONORES DE Ø 125 mm. DEUX AVEC FREINS.  
CHARGE MAXIMALE: TOTAL 250 KG ET 80 KG PAR NIVEAU.

DEUTSCH

STRUKTUR AUS EDELSATHLROHR VON 1,5 mm DICKE.  
GERÄUSCHLOSE REGALE MIT DER STRUKTUR VERSCHWEISST. (VERSION MONTIERTE SERVIERWAGEN).  
BEWEGLICHE GERÄUSCHLOSE RÄDER Ø 125 mm, ZWEI MIT BREMSEN.  
MAXIMALE TRAGKRAFT: TOTAL 250 KG UND MAX 80 KG PRO REGAL.

Carro servicio acero inox / St/steel serving trolley / Chariot service en acier inox / Servierwagen Edelstahl

REF	ESTANTES / LEVELS / NIVEAUX / REGALE	DIM. ESTANTE / SHELF DIMENTION / DIM. NIVEAU / REGALGRÖSSE mm	A x B x C mm	U
P80.240	2	800 x 500	880 x 580 x 1015	1
P80.250	2	900 x 500	980 x 580 x 1015	1
P80.260*	2	1000 x 600	1080 x 680 x 1015	1
P80.270	3	800 x 500	880 x 580 x 1015	1
P80.280	3	900 x 500	980 x 580 x 1015	1
P80.290*	3	1000 x 600	1080 x 680 x 1015	1
P80.300	4	800 x 500	880 x 580 x 1300	1
P80.310	4	900 x 500	980 x 580 x 1300	1
P80.320*	4	1000 x 600	1080 x 680 x 1300	1

\*Estantes de chapa de mayor espesor / Thicker shelves / Plateaux plus épais / Regal aus dickerem Blech

Disponible también con ruedas poliamida. Consultar precio.  
Available also on polyamide castors. Please ask for price.  
Disponible aussi avec roulettes polyamide. Consulter prix.  
Auch lieferbar mit Polyamidrädern. Bitte Preis nachfragen.

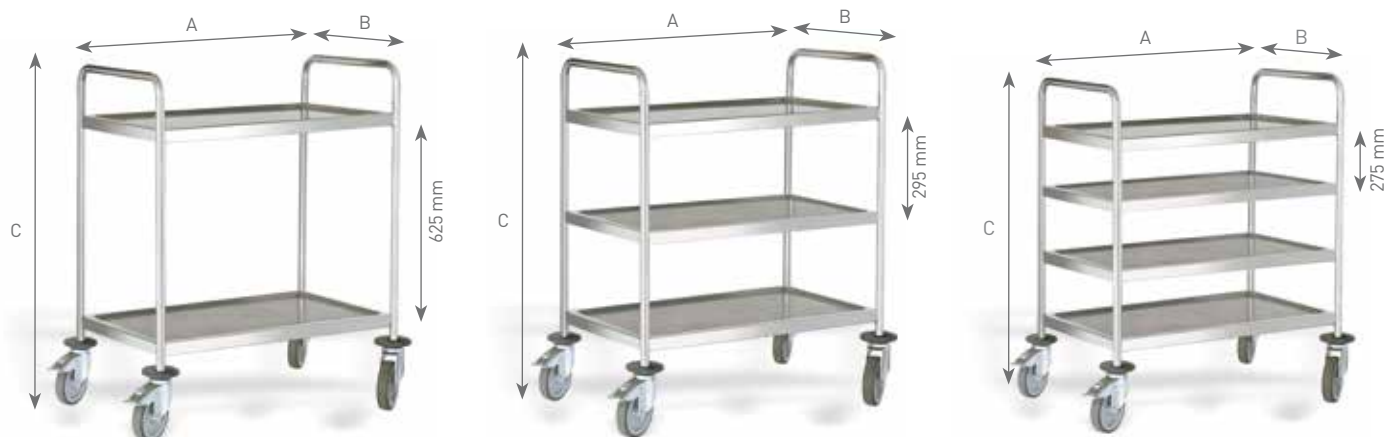

### 3.3. CARROS / TROLLEYS / CHARIOTS / SERVIERWAGEN

#### CARROS DE SERVICIO DESMONTABLES / DISASSEMBLED SERVING TROLLEYS / CHARIOTS DE SERVICE DÉMONTABLES / DEMONTIERBARE SERVIERWAGEN

ESPAÑOL

SE ENTREGAN DESMONTADOS. MUY ROBUSTOS Y SÓLIDOS UNA VEZ MONTADOS. CARGA MÁXIMA POR BANDEJA DE 80 KG Y TOTAL MÁXIMO POR CARRO 250 KG. EL TIEMPO MEDIO DE MONTAJE ES DE 10 MINUTOS.

ENGLISH

DELIVERED FLATPACKED. VERY STRONG AND RESISTANT ONCE ASSEMBLED. MAXIMUM LOAD PER SHELF IS 80 KG AND MAXIMUM PER TROLLEY IS 250 KG. APPROXIMATE TIME OF ASSEMBLY IS ABOUT 10 MINUTES.

FRANÇAIS

LIVRÉS DÉMONTÉS. TRÈS ROBUSTES ET SOLIDES UNE FOIS MONTÉS. LA CHARGE MAX. PAR PLATEAU EST 80 KG ET PAR CHARIOT 250 KG. TEMPS MOYEN DE MONTAGE 10 MIN.

DEUTSCH

LIEFERUNG UNMONTIERT. EINMAL MONTIERT SIND SIE SEHR ROBUST UND SOLIDE. MAXIMALE TRAGKRAFT PRO REGAL 80 KG UND TOTAL 250 KG. DIE MONTAGE DAUERT IM DURCHSCHNITT 10 MINUTEN.

#### Carro desmontable / Disassembled trolley / Chariot démontable / Demontierbarer Servierwagen

REF	ESTANTES / LEVELS / NIVEAUX / REGALE	DIM. ESTANTE / SHELF DIMENTION / DIM. NIVEAU / REGALGRÖSSE mm	A x B x C mm	U
P80.330	2	800 x 500	810 x 545 x 1040	1
P80.340	2	900 x 500	910 x 545 x 1040	1
P80.350	3	800 x 500	810 x 545 x 1040	1
P80.360	3	900 x 500	910 x 545 x 1040	1

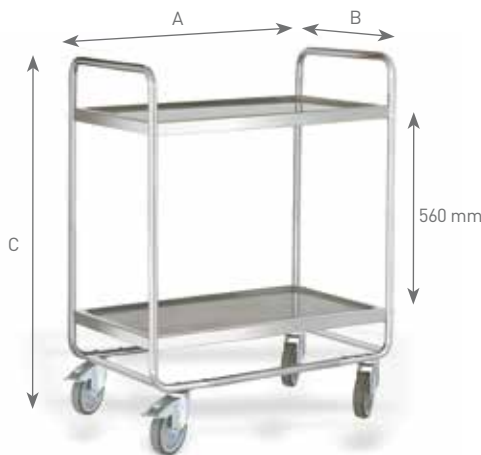

#### Carro desmontable ligero / Light disassembled trolley / Chariot démontable légère / Leichter demontierbarer Servierwagen

Ruedas acero Ø 100 mm. Dos con freno.  
Castors Ø 100 mm. Two with brakes.  
Roulettes Ø 100 mm. Deux avec freins.  
Edelstahlräder Ø 100 mm. Zwei mit Bremsen.

REF	ESTANTES / LEVELS / NIVEAUX / REGALE	DIM. ESTANTE / SHELF DIMENTION / DIM. NIVEAU / REGALGRÖSSE mm	U
P80.960	2	830 x 510	1
P80.961	3	830 x 510	1

**GAMA ECONÓMICA / ECONOMIC LINE / GAMME ECONOMIQUE / ÖKONOMISCHE SERIE**



CARROS DE SERVICIO SOLDADOS / WELDED SERVING TROLLEYS / CHARIOTS DE SERVICE SOUDÉS / GESCHWEISSTE SERVIERWAGEN

**P8094** Carro servicio con barandilla / Serving trolley with guard-rail shelf / Chariot service avec galerie / Servierwagen mit Geländer

REF	ESTANTES / LEVELS / NIVEAUX / REGALE	DIM ESTANTE / SHELF DIMENTION / DIM NIVEAU / REGALGRÖSSE mm	U
P80.940	2	800 x 500	1
P80.941	3	800 x 500	1

Disponible también con ruedas poliamida. Consultar precio.  
Available also on polyamide castors. Please ask for price.  
Disponibile aussi avec roulettes polyamide. Consulter prix.  
Auch lieferbar mit Polyamidrädern. Bitte Preis nachfragen.



**P8068** Carro desembarace inox / St/Steel clearing trolley / Chariot de débarrassage en inox / Abräumwagen

REF	ESTANTES / LEVELS / NIVEAUX / REGALE	DIM ESTANTE / SHELF DIMENTION / DIM NIVEAU / REGALGRÖSSE mm	U
P80.680	2	1000 x 600	1

Disponibile también con ruedas poliamida. Consultar precio.  
Available also on polyamide castors. Please ask for price.  
Disponibile aussi avec roulettes polyamide. Consulter prix.  
Auch lieferbar mit Polyamidrädern. Bitte Preis nachfragen.

No incluye cubeta Gastronorm 1/2.  
1/2 Gastronorm container not included.  
Bac Gastronorme 1/2 non inclus.  
1/2 Gastronorm Behälter nicht im Preis inklusive.

Ø 165 mm



**P80374** Cubertero para carro servicio / Cutlery dispenser for serving trolley / Ramasse-couverts pour chariot service / Behälter für Servicewagen

REF	Mod	H mm	U
P80.374	GN 1/3	150	1







**P8080** Carro basculante 17 guías GN 1/1 / Swinging trolley 17 rails for 1/1 GN pans / Chariot basculant 17 glissières pour bacs GN 1/1 / Klappbarer Servierwagen mit 17 Einschüben für GN 1/1

**PATENTED / EXCLUSIVE**



REF	U
P80.800	1

Entrada 325 mm  
Entrance 325 mm  
Entrée 325 mm  
Eingang 325 mm

Carro especial para pequeños desniveles /  
Special trolley for uneven surfaces /  
Chariot spécial pour légers dénivelés /  
Spezieller Wagen für kleine Unebenheiten

**IDEA!** Ideal para catering y cámaras frigoríficas /  
Ideal for catering service and cold rooms /  
Idéal pour traiteurs et chambres froides /  
Ideal für Catering oder Kühlkammern

**P8043** Carro 17 guías GN 1/1 / 17 rails trolley for 1/1 GN pans / Chariot 17 glissières pour bacs GN 1/1 / Servierwagen mit 17 Einschüben für GN 1/1



REF	U
P80.430	1

Entrada 325 mm  
Entrance 325 mm  
Entrée 325 mm  
Eingang 325 mm

Disponible también con ruedas poliamida. Consultar precio.  
Available also on polyamide castors. Please ask for price.  
Disponible aussi avec roulettes polyamide. Consulter prix.  
Auch lieferbar mit Polyamidrädern. Bitte Preis nachfragen.

**P8067** Carro doble 17 x 2 guías 1/1 / Double rail trolley 17 x 2 for 1/1 GN pans / Chariot double 17 x 2 glissières pour bacs GN 1/1 / Doppelservierwagen mit 17 x 2 Einschüben für GN 1/1



REF	U
P80.670	1

Entrada 325 mm  
Entrance 325 mm  
Entrée 325 mm  
Eingang 325 mm

Disponible también con ruedas poliamida. Consultar precio.  
Available also on polyamide castors. Please ask for price.  
Disponible aussi avec roulettes polyamide. Consulter prix.  
Auch lieferbar mit Polyamidrädern. Bitte Preis nachfragen.

TRANSPORTE Y ALMACENAMIENTO /  
TRANSPORT & STORAGE /  
TRANSPORT ET STOCKAGE

**P8052** Carro encastrable 17 guías GN 1/1 / Stackable trolley 17 rails for 1/1 GN pans /  
 Chariot emboîtable 17 glissières pour bacs GN 1/1 / Klappbarer Servierwagen mit 17 Einschüben für GN 1/1

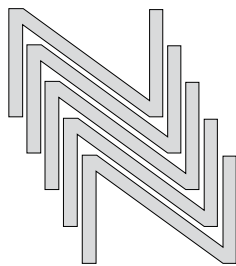

REF	U
P80.520	1

Entrada 325 mm  
 Entrance 325 mm  
 Entrée 325 mm  
 Eingang 325 mm

Disponible también con ruedas poliamida. Consultar precio.  
 Available also on polyamide castors. Please ask for price.  
 Disponible aussi avec roulettes polyamide. Consulter prix.  
 Auch lieferbar mit Polyamidrädern. Bitte Preis nachfragen.

**P8047** Carro desmontable 17 guías GN 1/1 / Disassembled trolley 17 rails for 1/1 GN pans /  
 Chariot démontable 17 glissières pour bacs GN 1/1 / Demontierbarer Servierwagen mit 17 Einschüben für GN 1/1

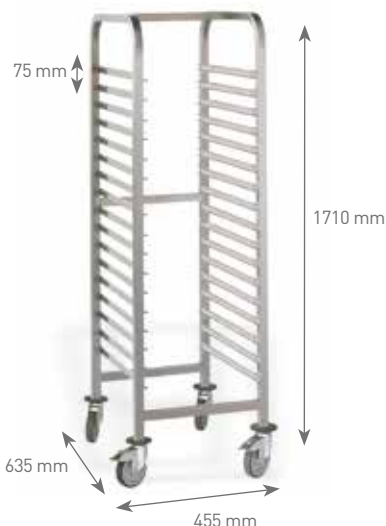

REF	U
P80.470	1

Entrada 325 mm  
 Entrance 325 mm  
 Entrée 325 mm  
 Eingang 325 mm

Disponible también con ruedas poliamida. Consultar precio.  
 Available also on polyamide castors. Please ask for price.  
 Disponible aussi avec roulettes polyamide. Consulter prix.  
 Auch lieferbar mit Polyamidrädern. Bitte Preis nachfragen.

Desmontado /  
 Flat packed /  
 Livré démonté /  
 Demontiert

**P8097** Carro desmontable ligero 15 guías GN 1/1 / Light Disassembled trolley 15 rails for 1/1 GN pans /  
 Chariot démontable léger 15 glissières pour bacs GN 1/1 /  
 Leichter Demontierbarer Servierwagen mit 15 Einschüben für GN 1/1



REF	U
P80.970	1

Entrada 325 mm  
 Entrance 325 mm  
 Entrée 325 mm  
 Eingang 325 mm

Ruedas acero Ø 120 mm. Dos con freno.  
 Castors Ø 120 mm. Two with brakes.  
 Roulettes Ø 120 mm. Deux avec freins.  
 Edelstahlrollen Ø 120 mm. Zwei mit Bremsen.

GAMA ECONÓMICA /  
 ECONOMIC LINE /  
 GAMME ECONOMIQUE /  
 ÖKONOMISCHE SERIE

**P8044** Carro 17 guías GN 2/1 / 17 rails trolley for 2/1 GN pans /  
 Chariot 17 glissières pour bacs GN 2/1 / Servierwagen mit 17 Einschüben für GN 2/1



REF	U
P80.440	1

Entrada 530 mm  
 Entrance 530 mm  
 Entrée 530 mm  
 Eingang 530 mm

Disponible también con ruedas poliamida. Consultar precio.  
 Available also on polyamide castors. Please ask for price.  
 Disponible aussi avec roulettes polyamide. Consulter prix.  
 Auch lieferbar mit Polyamidrädern. Bitte Preis nachfragen.

**P8048** Carro desmontable 17 guías GN 2/1 / Disassembled trolley 17 rails for 2/1 GN pans /  
 Chariot démontable 17 glissières pour bacs GN 2/1 / Demontierbarer Servierwagen mit 17 Einschüben für GN 2/1



REF	U
P80.480	1

Entrada 530 mm  
 Entrance 530 mm  
 Entrée 530 mm  
 Eingang 530 mm

Disponible también con ruedas poliamida. Consultar precio.  
 Available also on polyamide castors. Please ask for price.  
 Disponible aussi avec roulettes polyamide. Consulter prix.  
 Auch lieferbar mit Polyamidrädern. Bitte Preis nachfragen.

Desmontado /  
 Flat packed /  
 Livré démonté /  
 Demontiert

**P8051** Carro encastrable 17 guías GN 2/1 / Stackable trolley 17 rails for 2/1 GN pans /  
 Chariot emboîtable 17 glissières pour bacs GN 2/1 / Klappbarer Servierwagen mit 17 Einschüben für GN 2/1

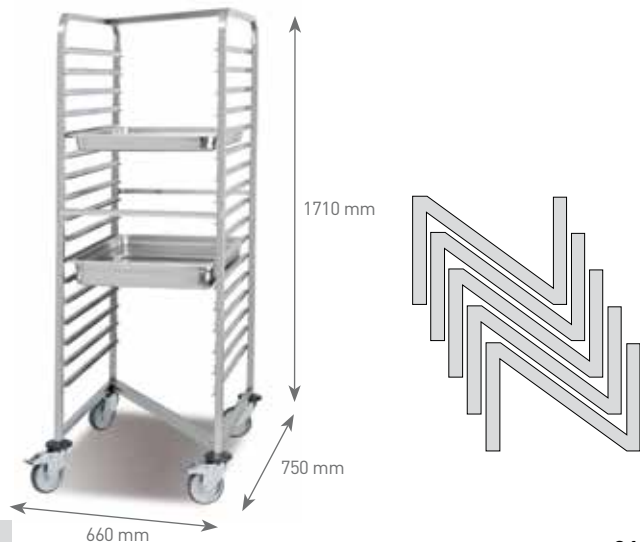

REF	U
P80.510	1

Entrada 530 mm  
 Entrance 530 mm  
 Entrée 530 mm  
 Eingang 530 mm

Disponible también con ruedas poliamida. Consultar precio.  
 Available also on polyamide castors. Please ask for price.  
 Disponible aussi avec roulettes polyamide. Consulter prix.  
 Auch lieferbar mit Polyamidrädern. Bitte Preis nachfragen.

TRANSPORTE Y ALMACENAMIENTO /  
 TRANSPORT & STORAGE /  
 TRANSPORT ET STOCKAGE

**P8084 / P8085 / P8046** Carro pastelería / Pastry trolley / Chariot pâtisserie / Patisseriewagen



REF	MEDIDA GUÍAS / SIZE OF RAILS / DIMENSIONS GLISSIÈRES / EINSCHUBGRÖSSEN mm	Nº GUÍAS / NR. OF LEVELS / NUM. NIVEAUX / NR. EINSCHÜBE	DISTANCIA ENTRE GUÍAS / DISTANCE BETWEEN LEVELS / ESPACE ENTRE NIVEAUX / EINSCHUBABSTÄNDE mm	U
P80.840	600 x 400	15	85	1
P80.850	600 x 400	20	70	1
P80.460	600 x 400	30	45	1

Entrada 400 mm  
Entrance 400 mm  
Entrée 400 mm  
Eingang 400 mm

Disponible también con ruedas poliamida. Consultar precio.  
Available also on polyamide castors. Please ask for price.  
Disponible aussi avec roulettes polyamide. Consulter prix.  
Auch lieferbar mit Polyamidrädern. Bitte Preis nachfragen.

**P8087 / P8088 / P8050** Carro desmontable bandejas pastelería / Disassembled rail trolley for bakery / Chariots démontable pour plaques à pâtisserie / Demontierbarer Wagen für Patisserietabletts



REF	MEDIDA GUÍAS / SIZE OF RAILS / DIMENSIONS GLISSIÈRES / EINSCHUBGRÖSSEN mm	Nº GUÍAS / NR. OF LEVELS / NUM. NIVEAUX / NR. EINSCHÜBE	DISTANCIA ENTRE GUÍAS / DISTANCE BETWEEN LEVELS / ESPACE ENTRE NIVEAUX / EINSCHUBABSTÄNDE mm	U
P80.870	600 x 400	15	85	1
P80.880	600 x 400	20	70	1
P80.500	600 x 400	30	45	1

Entrada 400 mm  
Entrance 400 mm  
Entrée 400 mm  
Eingang 400 mm

Disponible también con ruedas poliamida. Consultar precio.  
Available also on polyamide castors. Please ask for price.  
Disponible aussi avec roulettes polyamide. Consulter prix.  
Auch lieferbar mit Polyamidrädern. Bitte Preis nachfragen.

Desmontado / Flat packed /  
Livré démonté / Demontiert

**P8053** Carro encastrable pastelería 15 guías / Stackable pastry trolley 15 rails / Chariot emboîtable pâtisserie 15 glissières / Klappbarer Patisseriewagen 15 Einschübe



REF	U
P80.530	1

Disponible también con ruedas poliamida. Consultar precio.  
Available also on polyamide castors. Please ask for price.  
Disponible aussi avec roulettes polyamide. Consulter prix.  
Auch lieferbar mit Polyamidrädern. Bitte Preis nachfragen.

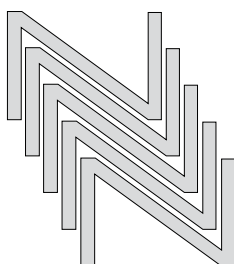



**P8081** Carro descongelación 9 guías / Defrost trolley 9 rails /  
Chariot à dégivrage 9 glissières / Auftauwagen mit 9 Einschüben

**PATENTED EXCLUSIVE**

REF	Mod	A x B x C mm	U
P80.810	GN 2/1	665 x 755 x 1720	1
P80.813	GN 1/1	455 x 635 x 1720	1



Ahorro de espacio en el proceso de descongelado de los alimentos  
Space saver while foodstuff defrost.  
Economie d'espace pendant le dégivrage des aliments.  
Platzsparend im Auftauverfahren von Lebensmitteln.

Disponible también con ruedas poliamida. Consultar precio.  
Available also on polyamide castors. Please ask for price.  
Disponible aussi avec roulettes polyamide. Consulter prix.  
Auch lieferbar mit Polyamidrädern. Bitte Preis nachfragen.

**P80811** Cubeta especial GN para carro descongelación / Special GN container for defrost trolley /  
Bac GN spécial pour chariot dégivrage / Spezial GN Behälter zum Auftauen

REF	Mod	mm	H mm	Lts	U
P80.811	GN 2/1	650 x 530	100,0	28,90	1
P80.814	GN 1/1	530 x 325	100,0	14,20	1

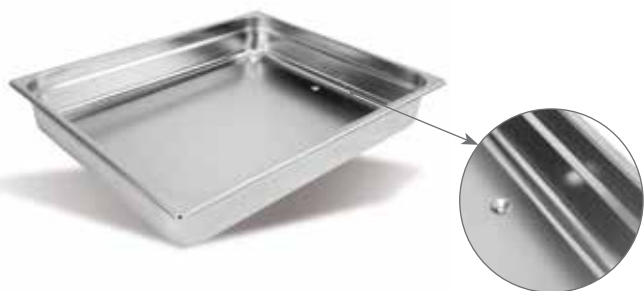

Cubeta con desagüe.  
Container with drainer hole.  
Bac avec dégorgeement.  
Behälter mit Abwasserloch.

**P215 / P115** Fondo perforado para cubeta / Perforated bottom /  
Egouttoir pour bac / Gelochter Einlegeboden für Behälter

REF	Mod	U
P215.000 <sup>1</sup>	GN 2/1	1
P115.000 <sup>2</sup>	GN 1/1	1



<sup>1</sup> Recomendado para ref. 80811  
Recommended for item code 80811  
Recommandé pour réf. 80811  
Empfohlen für Art.Nr. 80811

<sup>2</sup> Recomendado para ref. 80814  
Recommended for item code 80814  
Recommandé pour réf. 80814  
Empfohlen für Art.Nr. 80814

CARROS CON GUÍAS / RAIL TROLLEYS / CHARIOT À GLISSIÈRES / SERVIERWAGEN MIT EINSCHÜBEN

ESPAÑOL

CARRO DE ACERO INOXIDABLE ESPECIALMENTE DISEÑADO PARA HORNOS DE PASTERÍA Y PANIFICACIÓN. GUÍAS EN FORMA DE "L" CON TOPE ANTIDESLIZAMIENTO DE 90° PARA EVITAR DESPLAZAMIENTOS DE LAS BANDEJAS DURANTE SU TRANSPORTE.

ENGLISH

ST/STEEL TROLLEY SPECIALLY DESIGNED FOR PASTRY AND BAKERY OVENS. 90° "L" SHAPED RAILS TO AVOID MOVEMENTS OF TRAYS DURING TRANSPORTATION.

FRANÇAIS

CHARIOT EN ACIER INOXYDABLE SPÉCIALMENT CONÇU POUR FOURS DE PÂTISSERIE ET DE BOULANGERIE. GLISSIÈRES EN "L" A 90° POUR ÉVITER LES DÉPLACEMENTS PENDANT LE TRANSPORT.

DEUTSCH

WAGEN AUS ROSTFREIEM STAHL SPEZIELL FÜR PATISSERIE- UND BÄCKEREIBACKOFEN ENTWICKELT. EINSCHÜBE IN "L" FORM MIT 90° ANTIRUTSCHVERANKERUNG UM DAS VERRUTSCHEN DER TABLETTS BEIM TRANSPORT AUSZUSCHLIESSEN.



Ruedas giratorias de Ø 100 mm resistentes a altas temperaturas.  
Revolving castors Ø 100 mm heat resistant.  
Roulettes de Ø 100 mm résistantes à hautes températures.  
Bewegliche Räder Ø 100 mm resistent gegen hohe Temperaturen.

● - 30 °C  
● + 280 °C

**P8089** Carro 17 guías para horno / Oven rail trolley 17 rails / Chariot pour four 17 glissières / Wagen für Backofen 17 Einschübe

ESPECIAL HORNO PANADERO / SPECIAL TROLLEY FOR BAKERY / CHARIOT SPECIAL BOULANGERIE / SPEZIELL BÄCKEREIOFEN

REF	MEDIDA GUÍAS / SIZE OF RAILS / DIMENSIONS GLISSIÈRES / EINSCHUBGRÖSSE mm	U
P80.890	600 x 800	1
P80.891*	600 x 800	1

Entrada 600 mm  
Entrance 600 mm  
Entrée 600 mm  
Eingang 600 mm

\* Carro sin tejadillo acero inox  
\* Trolley without St/Steel roof  
\* Chariot sans toit en acier inox  
\* Wagen ohne Edelstahl Dach



**P8095** Carro self-service 12 guías / Self-service trolley 12 rails /  
 Chariot self-service 12 glissières / Selbstbedienungswagen 12 Einschübe



REF	U
P80.950	1
P80.951*	1

Para bandejas de ancho 365 mm hasta 420 mm  
 For trays from 365 mm to 420 mm width  
 Pour plateaux de 365 mm à 420 mm  
 Für Tablettis der Breite von 365 mm bis 420 mm.

- \* Con dos paneles laterales composite+aluminio.
- \* With two side panels made of aluminium+composite .
- \* Avec deux panneaux latéraux en composite+aluminium.
- \* Mit zwei Seitenwänden aus composite+Aluminium.

**P8091** Carro doble para bandejas fast-food 12 guías / Double fast-food tray trolley 12 rails /  
 Chariot double pour plateaux fast-food 12 glissières / Doppelwagen für Fast-Food Tablettis 12 Einschübe



REF	MEDIDA GUÍAS / SIZE OF RAILS / DIMENSIONS GLISSIÈRES / EINSCHUBGRÖSSE mm	U
P80.910	480 x 800	1

Entrada 480 mm  
 Entrance 480 mm  
 Entrée 480 mm  
 Eingang 480 mm

Ideal para bandejas 480 x 370 mm  
 Suitable for trays 480 x 370 mm  
 Ideal pour plateaux 480 x 370 mm  
 Ideal für Tablettis 480 x 370 mm

Disponible también con ruedas poliamida. Consultar precio.  
 Available also on polyamide castors. Please ask for price.  
 Disponible aussi avec roulettes polyamide. Consulter prix.  
 Auch lieferbar mit Polyamidrädern. Bitte Preis nachfragen.

**P925** Carro transporte bandejas isotérmicas / Transport trolley for isothermal trays /  
 Chariot transport plateaux isothermes / Transportwagen für isothermische Tablettis



REF	MEDIDA GUÍAS / SIZE OF RAILS / DIMENSIONS GLISSIÈRES / EINSCHUBGRÖSSE mm	Nº GUÍAS / NR. OF LEVELS / NUM. NIVEAUX / NR. EINSCHÜBE	U
P925.001	550 x 375	10	1
P925.002	550 x 375	20	1

**P8039** Carro porta cubetas GN / GN containers transport trolley /  
 Chariot transport bacs GN / Transportwagen für GN Behälter



REF	U
P80.390	1

No incluye cubetas GN.  
 GN containers not included.  
 Bacs GN non inclus.  
 GN Behälter nicht inklusive.

Disponible también con ruedas poliamida. Consultar precio.  
 Available also on polyamide castors. Please ask for price.  
 Disponible aussi avec roulettes polyamide. Consulter prix.  
 Auch lieferbar mit Polyamidrädern. Bitte Preis nachfragen.

**P8038** Carro porta cubeta GN 2/1 / 2/1 GN transport trolley /  
 Chariot transport bac GN 2/1 / Transportwagen für GN Behälter 2/1



REF	U
P80.380	1

No incluye cubetas GN.  
 GN containers not included.  
 Bacs GN non inclus.  
 GN Behälter nicht inklusive.

Disponible también con ruedas poliamida. Consultar precio.  
 Available also on polyamide castors. Please ask for price.  
 Disponible aussi avec roulettes polyamide. Consulter prix.  
 Auch lieferbar mit Polyamidrädern. Bitte Preis nachfragen.

Ref. 8039 / 8038

CARRO TRANSPORTE PARA CUBETAS GN  
 TRANSPORT TROLLEY FOR GN CONTAINERS  
 CHARIOTS DE TRANSPORT POUR BACS GN  
 TRANSPORTWAGEN FÜR GN BAEHÄLTER

Fabricados en acero inoxidable. Ideales para el almacenaje y transporte de alimentos preparados y salsas en grandes cantidades.  
 Made of St/Steel. Perfect for storing and transporting large quantities of prepared food and sauces.  
 Fabriqués en acier inoxydable. Idéales pour le stockage et le transport d'aliments cuisinés et sauces en grandes quantités.  
 Hergestellt aus Edelstahl. Ideal für die Lagerung und den Transport von vorbereiteten Lebensmittel und Sossen in grossen Mengen.

**P8074** Carro portacubiertos GN 1/3 y porta bandejas / Trolley cutlery dispenser GN 1/3 /  
 Chariot porte-ramasse couverts GN 1/3 / Transportwagen für GN 1/3 Besteckbehälter und Tablett



REF	U
P80.740	1

No incluye cubetas GN.  
 GN containers not included.  
 Bacs GN non inclus.  
 GN Behälter nicht inklusive.

Disponible también con ruedas poliamida. Consultar precio.  
 Available also on polyamide castors. Please ask for price.  
 Disponible aussi avec roulettes polyamide. Consulter prix.  
 Auch lieferbar mit Polyamidrädern. Bitte Preis nachfragen.



**P8057** Carro para cargas pesadas / Trolley for heavy loads / Chariot à charges lourdes / Wagen für schwere Last



REF	U
P80.570	1

Carga máxima: 350 kg  
Maximum load: 350 kg  
Charge maximale: 350 kg  
Maximale Tragkraft: 350 kg

**P8054** Carro transporte bandejas 7 guías / Tray transport trolley 7 rails / Chariot transport plateaux 7 glissières / Tabletttransportwagen 7 Einschübe

REF	MEDIDA GUÍAS / SIZE OF RAILS / DIMENSIONS GLISSIÈRES / EINSCHUBGRÖSSE	A x B x C mm	DISTANCIA ENTRE GUÍAS / DISTANCE BETWEEN LEVELS / ESPACE ENTRE NIVEAUX / EINSCHUBABSTAND mm	U
P80.540	GN 1/1	455 x 635 x 900	75	1
P80.550	GN 2/1	660 x 750 x 900	75	1
P80.560	Pastelería / Pastry / Pâtisserie / Patisserie (600 x 400 mm)	525 x 700 x 900	85	1
P80.780	GN 1/1 Doble	810 x 635 x 900	75	1

Ref. P80.540

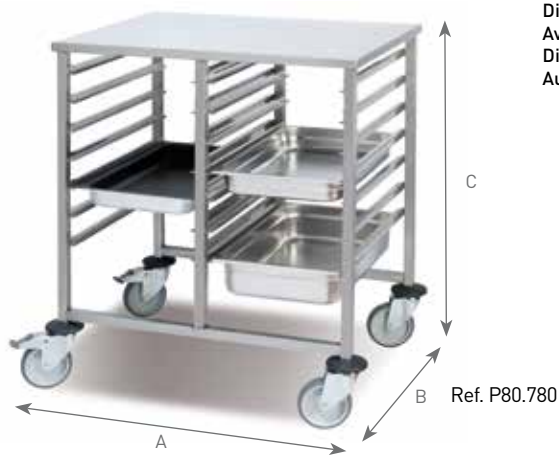

Disponible también con ruedas poliamida. Consultar precio.  
Available also on polyamide castors. Please ask for price.  
Disponible aussi avec roulettes polyamide. Consulter prix.  
Auch lieferbar mit Polyamidrädern. Bitte Preis nachfragen.

**P8061 / P8062 / P8063**

Fundas desechables de polietileno para carros (rollo de 100 unidades) /  
Disposable covers for trolleys (pack 100 pieces) /  
Housses jetables pour chariots (rouleau de 100 unités) /  
Einweghüllen aus Polyethylen für Wagen (Rollen von 100 Stück)



REF		U
P80.610	para carro 1/1 / for trolley 1/1 / pour chariot 1/1 / für Wagen 1/1	1
P80.620	para carro 2/1 / for trolley 2/1 / pour chariot 2/1 / für Wagen 2/1	1
P80.630	para carro pastelería 600 x 400 / for pastry trolley 600 x 400 / pour chariot pâtisserie 600 x 400 / für Patisseriewagen 600 x 400	1
P80.640	dispensador / dispenser / distributeur / Rollenhalter	1

Polietileno de densidad media.  
Medium density polyethylene.  
Poliéthylène de densité moyenne.  
Polyethylen mittlere Stärke.

Para carros altos.  
For high trolleys.  
Pour chariots hauts.  
Für hohe Wagen.

**P5015 / P5017** Carro de plástico para cestas / Plastic trolley for dishwasher racks / Chariot pour casiers à vaisselle / Plastikwagen für Spülkörbe



REF		L mm	U
P5015	sin asa / without handle / sans anse / ohne Griff	230	1
P5017	con asa / with handle / avec anse / mit Griff	980	1



**P8058 / P8059** Carro inox para cestas / St/steel trolley for dishwasher racks / Chariot inox pour casiers à vaisselle / Edelstahlwagen für Spülkörbe



REF		U
P80.580	con asa / with handle / avec anse / mit Griff	1
P80.590	sin asa / without handle / sans anse / ohne Griff	1



**P8075 / P8076 / P8077** Carro para cestas Vajillas / Dishwasher rack trolley / Chariot casiers à vaisselle / Wagen für Spülkörbe



REF	MEDIDA GUÍAS / SIZE OF RAILS / DIMENSIONS GLISSIÈRES / EINSCHUBGRÖSSE mm	Nº GUÍAS / NR. OF LEVELS / NUM. NIVEAUX / NR. EINSCHÜBE	A x B x C mm	U
P80.750	500 x 500	5	640 x 633 x 1160	1
P80.760	500 x 500	9	640 x 633 x 1710	1
P80.770	500 x 500 (doble/double)	9	1185 x 633 x 1710	1



**ADC-4** Carro ajustable para platos / Adjustable dish caddy /  
 Chariot modulable pour assiettes / Einstellbarer Tellerwagen



REF	U
ADC-4	1

Se sirve con 4 columnas separadoras más una funda protectora.  
 Delivered with 4 posts plus 1 protection cover.  
 Livré avec 4 colonnes de séparation et 1 housse de protection.  
 Lieferung mit 4 Unterteilungssäulen und einer Schutzhülle.

Ajuste único y fácil por la parte superior.  
 Unique and easy adjustment from the top.  
 Reglage unique et facile de la partie supérieure.  
 Einzigartige und einfache Einstellung des Oberteils.

COMBINACIONES /  
 COMBINATIONS /  
 COMBINATIONS /  
 KOMBINATIONEN

Tamaño platos  
 Size plates  
 Taille assiettes  
 Tellergröße

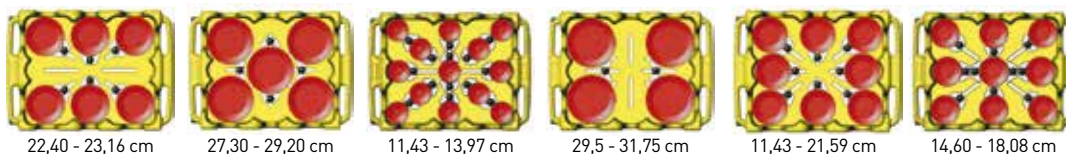

22,40 - 23,16 cm

27,30 - 29,20 cm

11,43 - 13,97 cm

29,5 - 31,75 cm

11,43 - 21,59 cm

14,60 - 18,08 cm

**SAC-SQ5-06** Carro ajustable para platos cuadrados y redondos / Adjustable caddy for square & round dishes /  
 Chariot modulable pour assiettes carrées et rondes / Einstellbarer Wagen für runde und quadratische Teller



Diseño exclusivo apilable.  
 Unique, stackable design.  
 Design exclusif empilable.  
 Exclusives Design stapelbar.



REF	U
SAC-SQ5-06	1

Se sirve con 5 columnas separadoras una de ellas en forma de cruz más una funda protectora.  
 Delivered with 5 posts, one of them in cross shape plus 1 protection cover.

Livré avec 5 colonnes de séparation une desquelles en forme de croix plus 1 housse de protection.  
 Lieferung mit 5 Unterteilungssäulen, eine von Ihnen in Kreuzform und einer Schutzhülle.

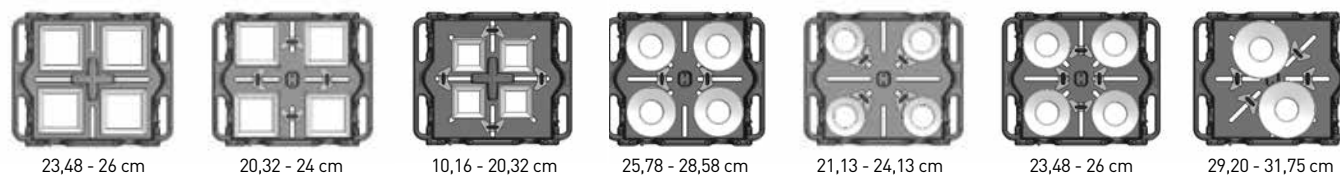

23,48 - 26 cm

20,32 - 24 cm

10,16 - 20,32 cm

25,78 - 28,58 cm

21,13 - 24,13 cm

23,48 - 26 cm

29,20 - 31,75 cm

**ADP** Columna separadora carro platos / Post for dish trolley /  
 Colonne séparation chariot assiettes / Unterteilungssäule für Tellerwagen



REF	U
ADP	1

Compatible ref: ADC-4 y SAC-SQ5-06.  
 Compatible ref: ADC-4 & SAC-SQ5-06.  
 Compatible réf: ADC-4 et SAC-SQ5-06.  
 Passend für Art.Nr.: ADC-4 und SAC-SQ5-06.

ESTANTERÍAS MODULARES DE ALUMINIO Y POLIPROPILENO /  
ALUMINIUM AND POLYPROPYLENE MODULAR SHELVING /  
ÉTAGÈRES MODULABLES EN ALUMINIUM ET POLYPROPYLÈNE /  
KOMBINIERBARE REGALMODULE AUS ALUMINIUM UND POLYPROPYLEN

ESPAÑOL

**ANTICORROSION** - ESTANTERÍAS INOXIDABLES FABRICADAS CON ESTRUCTURA DE ALUMINIO ANODIZADO ESPECIAL QUE LAS HACE RESISTENTES AL FRÍO Y AL CALOR, LLEGANDO A SOPORTAR DESDE -30 °C HASTA +75 °C. ESTANTES/PARRILLAS DE POLIPROPILENO APTO PARA USO ALIMENTARIO.

ENGLISH

**ANTICORROSIVE** - RUST-RESISTANT SHELVING. MANUFACTURED WITH SPECIAL ANODISED ALUMINIUM FRAME PROVIDING COLD AND HEAT RESISTANCE FROM -30 °C TO +75 °C. POLYPROPYLENE RACK/SHELVES, SUITABLE FOR FOODSTUFFS USE.

FRANÇAIS

**ANTI-CORROSION** - ÉTAGÈRES INOXYDABLES, FABRIQUÉES AVEC UNE STRUCTURE EN ALUMINIUM ANODISÉ SPÉCIAL QUI LES FAIT RÉSISTANTES À LA CHALEUR ET AU FROID, DE -30 °C JUSQU'ÀUX +75 °C. CLAYETTES EN POLYPROPYLÈNE ALIMENTAIRE.

DEUTSCH

**ANTIKORROSION** - NICHT ROSTENDE REGALE AUS SPEZIAL ELOXIERTEM ALUMINIUM HERGESTELLT, WELCHES SIE RESISTENT GEGEN KÄLTE UND WÄRME MACHT (VON -30 °C BIS +75 °C). REGALE UND BÖDEN AUS POLYPROPYLEN GEEIGNET FÜR LEBENSMITTEL.

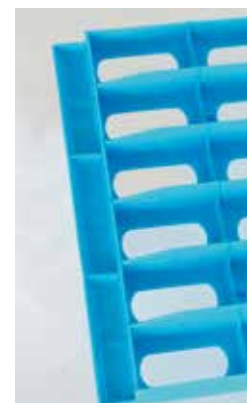

FACILIDAD Y RAPIDEZ DE MONTAJE /  
EASY AND QUICK ASSEMBLY /  
FACILE ET RAPIDE MONTAGE /  
EINFACHE UND SCHNELLE MONTAGE

**ROBUSTEZ Y RESISTENCIA**

MUY ROBUSTAS Y RESISTENTES CON UNA CAPACIDAD DE CARGA POR ESTANTE DE 150 KG (CARGA REPARTIDA UNIFORMEMENTE A LO LARGO DE TODO EL ESTANTE) Y TOTAL POR CONJUNTO ESTANTERÍA DE 420 KG.

ESTANTES/PARRILLAS CON UN DISEÑO ESPECIAL QUE DA GRAN ROBUSTEZ A LA MISMA Y HACE QUE EL APOYO SOBRE LA ESTANTERÍA SEA MUY FIRME Y RESISTENTE.

**ROBUSTNESS AND RESISTANCE**

VERY STRONG AND RESISTANT WITH A LOAD CAPACITY PER SHELF OF 150 KG (UNIFORMLY DISTRIBUTED LOAD ALONG THE ENTIRE SHELF) AND 420 KG TOTAL SHELVING.

RACK/SHELVES WITH A SPECIAL DESIGN PROVIDING ROBUSTNESS TO ITSELF AND PROVIDING ALSO A VERY STRONG AND RESISTANT SUPPORT ON THE FRAME.

**ROBUSTESSE ET RESISTANCE**

TRÈS ROBUSTES ET RÉSISTANTES, AVEC UNE CHARGE MAXIMALE DE 150 KG (POIDS RÉPARTIE UNIFORMEMENT TOUT AU LONG DE L'ÉTAGÈRE) PAR NIVEAU ET 420 KG DE CHARGE TOTALE.

CLAYETTES AVEC UN DESSIN QUI DONNE UNE GRANDE ROBUSTESSE ET UN APPUI TRÈS FERME ET SOLIDE SUR LA STRUCTURE.

**ROBUST UND RESISTENT**

SEHR ROBUST UND RESISTENT MIT EINER TRAGKRAFT VON 150 KG PRO REGALBODEN (LAST GLEICHMÄSSIG AUF DER LÄNGE DES REGALBODENS VERTEILT) UND DIE GESAMTTRAGKRAFT DES REGALS BETRÄGT 420 KG.

REGALBÖDEN/GITTER MIT SPEZIELLEM DESIGN, WELCHES EINE GROSSE ROBUSTHEIT ANSICH VERLEIHT UND EINEN SEHR SICHEREN UND RESISTENTEN HALT GARANTIIERT.



ESTANTERÍAS MODULARES DE ALUMINIO Y POLIPROPILENO /  
ALUMINIUM AND POLYPROPYLENE MODULAR SHELVING /  
ÉTAGÈRES MODULABLES EN ALUMINIUM ET POLYPROPYLÈNE /  
KOMBINIERBARE REGALMODULE AUS ALUMINIUM UND POLYPROPYLEN

ESPAÑOL

**COMPATIBILIDAD CON GASTRONORM**

MEDIDAS ADAPTADAS A LA NORMA GASTRONORM. HAY DOS FONDOS DISPONIBLES, GASTRONORM 1/1 Y 2/3, QUE PERMITEN COLOCAR INDISTINTAMENTE TANTO LOS ESTANTES/PARILLAS O DIRECTAMENTE CUBETAS GASTRONORM 1/1 Ó 2/3 SEAN DE ACERO INOXIDABLE O DE POLICARBONATO (COMPATIBLES CON LA MAYORÍA DE CUBETAS GASTRONORM DEL MERCADO).

ENGLISH

**GASTRONORM COMPATIBILITY**

ADAPTED TO GASTRONORM SIZES. TWO AVAILABLE DEPTHS, 1/1 AND 2/3 GASTRONORM SIZES. IT IS POSSIBLE TO PUT EQUALLY THE RACK/SHELVES OR DIRECTLY THE 1/1 AND 2/3 GASTRONORM CONTAINERS, ST/STEEL OR POLYCARBONATE (COMPATIBLE WITH MOST OF GASTRONORM PANS OF THE MARKET).

FRANÇAIS

**COMPATIBILITÉ AVEC GASTRONORME**

ÉTAGÈRES ADAPTÉES AUX DIMENSIONS GASTRONORME. DEUX PROFONDEURS DISPONIBLES, GASTRONORME 1/1 ET 2/3. ON PEUT PARFAITEMENT Y POSER INDISTINCTEMENT LES CLAYETTES OU DIRECTEMENT LES BACS GASTRONORME 1/1 OU 2/3 SOIT EN INOX OU EN POLYCARBONATE (COMPATIBLES AVEC LA PLUPART DES BACS DU MARCHÉ).

DEUTSCH

**PASSEND FÜR GASTRONORM**

PASSEND FÜR GASTRONORMGRÖSSEN. ES GIBT ZWEI LIEFERBARE TIEFEN, GASTRONORM 1/1 UND 2/3. SOWOHL DIE REGAL/GITTERBODEN ALS AUCH DIE GASTRONORMBEHÄLTER 1/1 UND 2/3 AUS EDELSTAHL ODER POLYCARBONAT SIND IN DEN RAHMEN EINSETZBAR (PASSEND FÜR DIE MEISTEN GASTRONORMBEHÄLTER AUF DEM MARKT).



TRANSPORTE Y ALMACENAMIENTO /  
TRANSPORT & STORAGE /  
TRANSPORT ET STOCKAGE

ALUMINIO Y POLIPROPILENO / ALUMINIUM AND POLYPROPYLENE /  
ALUMINIUM ET POLYPROPYLÈNE / ALUMINIUM UND POLYPROPYLEN

### Parrillas / Rack shelves / Clayettes / Gitterböden

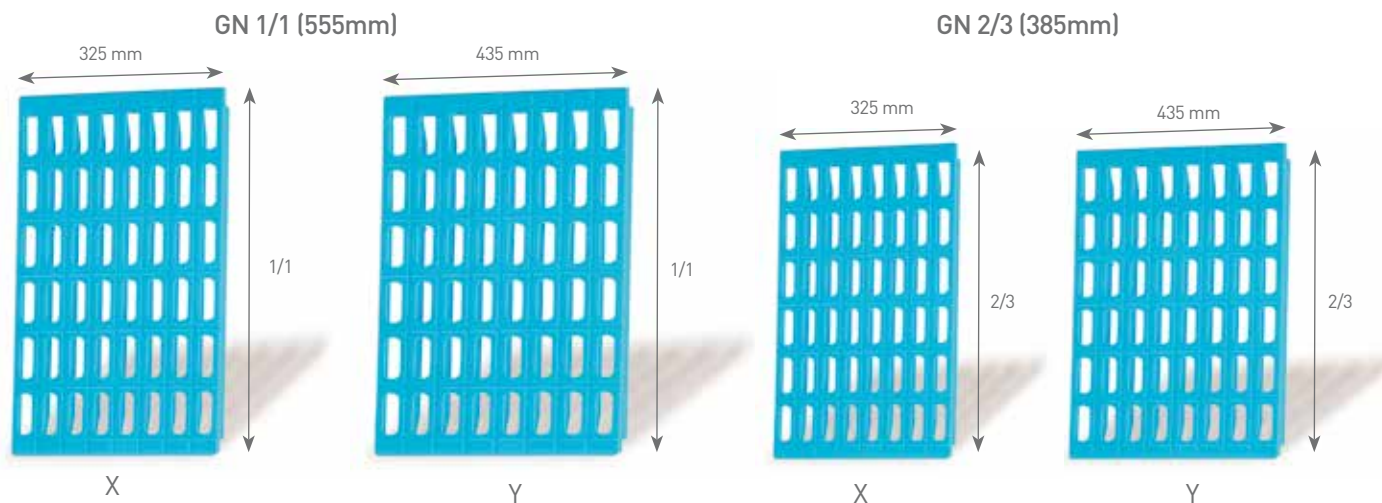

Apto para lavavajillas  
Dishwasher safe  
Apte pour lave-vaisselle  
Geeignet für Spülmaschinen

Combinando parrillas de la misma profundidad (X/Y) permite personalizar las longitudes de las estanterías a cada una de las necesidades. (Ver en página siguiente combinaciones propuestas)

Combining rack shelves among the same group (X/Y) allows to personalize the lengths of each shelf. (Refer to next page for proposed combinations)

En combinant des clayettes du même groupe (X/Y) permet de personnaliser les longueurs des étagères à n'importe quel besoin. (Voir page suivante pour des combinaisons proposées)

Die Kombination der Gitterböden gleicher Tiefe (X/Y) erlaubt die Länge der Regale individuell je nach Bedarf zu bestimmen. (Siehe Kombinerungsvorschläge folgende Seite)

### Pieza soporte travesaños / Support for grossbars / Crochet support pour largeron / Halterungsteil Traversen

Sistema especial de fijación de soporte para travesaños que ofrece la máxima seguridad, fiabilidad y robustez.

Special fixing system support for crossbars which offers the highest security, reliability and robustness.

Système spécial de fixation des supports pour longerons qui offre la sécurité, fiabilité et robustesse maximale.

Spezielles System der Halterverankerung für die Traversen, welches die höchste Sicherheit, Zuverlässigkeit und Robustheit bietet.



### Pies regulables / Leveling feet / Pieds régulateurs / Regulierbare Füße

Pies regulables con rosca oculta para suelos con desniveles. Con la posibilidad de adaptar ruedas de Ø 125 mm.

Levelling feet with hidden thread, for gradient floors. It is also possible to adapt Ø 125 mm wheels.

Pieds régulateurs avec filet cache.

Il est aussi possible d'y adapter des roues de Ø 125 mm.

Regulierbare Füße mit verborgenem Gewinde für unebene Böden. Mit der Möglichkeit Räder Ø 125 mm anzubringen.



Alturas estándar de los niveles / Standard heights of levels / Hauteur standard des niveaux / Standardhöhe der Ebenen

Altura 1280 mm / 3 niveles  
Height 1280 mm / 3 levels  
Hauteur 1280 mm / 3 niveaux  
Höhe 1280 mm / 3 Ebenen

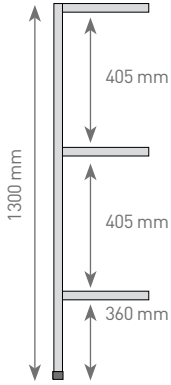

Altura 1750 mm / 3 niveles  
Height 1750 mm / 3 levels  
Hauteur 1750 mm / 3 niveaux  
Höhe 1750 mm / 3 Ebenen

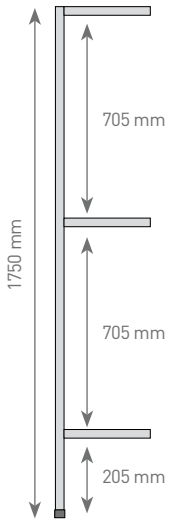

Altura 2050 mm / 4 niveles  
Height 2050 mm / 4 levels  
Hauteur 2050 mm / 4 niveaux  
Höhe 2050 mm / 4 Ebenen

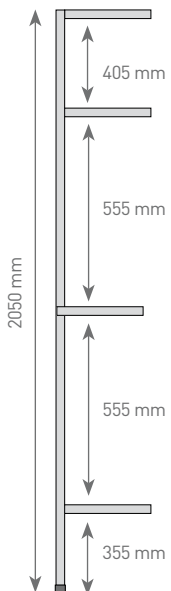

Altura 1750 mm / 4 niveles  
Height 1750 mm / 4 levels  
Hauteur 1750 mm / 4 niveaux  
Höhe 1750 mm / 4 Ebenen

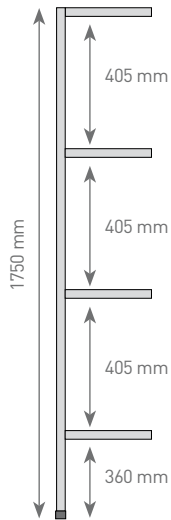

Altura 2050 mm / 5 niveles  
Height 2050 mm / 5 levels  
Hauteur 2050 mm / 5 niveaux  
Höhe 2050 mm / 5 Ebenen

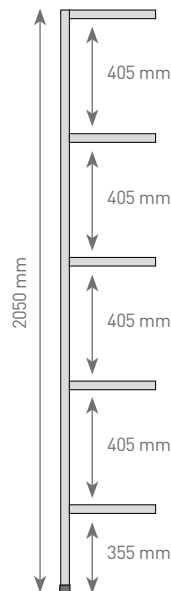

Altura 1750 mm / 5 niveles  
Height 1750 mm / 5 levels  
Hauteur 1750 mm / 5 niveaux  
Höhe 1750 mm / 5 Ebenen

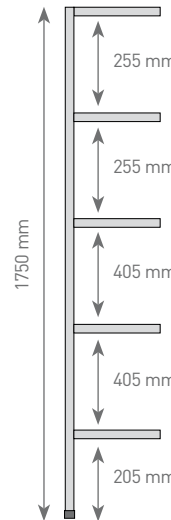

Altura 2050 mm / 6 niveles  
Height 2050 mm / 6 levels  
Hauteur 2050 mm / 6 niveaux  
Höhe 2050 mm / 6 Ebenen

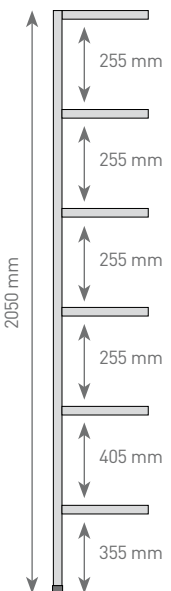

Combinaciones /  
Combinations /  
Combinaisons /  
Kombinationen

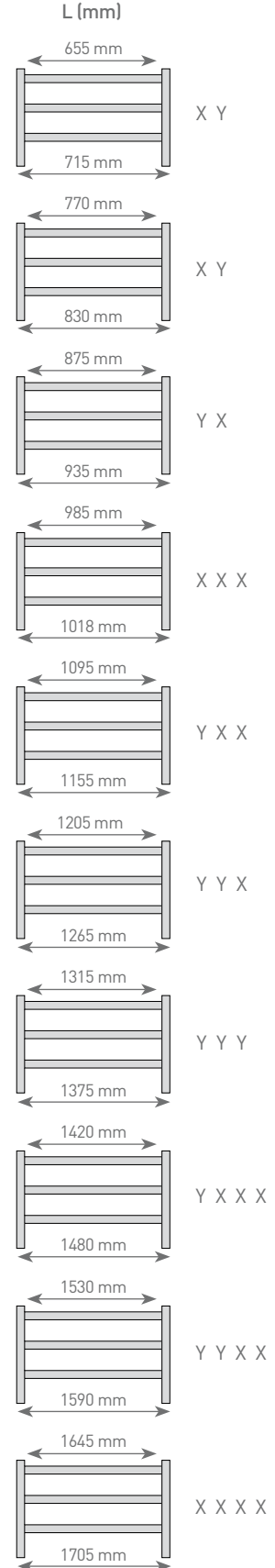

**ESTANTES (PARRILLAS + TRAVESAÑOS) / SHELVES (RACK/SHELVES + CROSSBARS) /  
 NIVEAU COMPLET (CLAYETTES + LONGERONS) / REGALE (GITTEBÖDEN + TRAVERSEN)**

Fondo 385 mm. Adaptable a las cubetas gastronorm 2/3  
 Depth 385 mm. Suitable for 2/3 gastronorm containers  
 Profondeur 385 mm. Adaptable aux bacs gastronorme 2/3  
 Tiefe 385 mm. Passend für Gastronormbehälter 2/3

X significa una parrilla de ancho 325 mm.  
 Y significa una parrilla de ancho 435 mm.

X is a rack 325 mm width.  
 Y is a rack 435 mm width.

X est une clayette de 325 mm de largeur.  
 Y est une clayette de 435 mm de largeur.

X Bezeichnet einen Einlegeboden der Breite von 325 mm.  
 Y Bezeichnet einen Gitterboden der Breite von 435 mm.

REF	MOD	COMBINACIÓN / COMBINATION / COMBINAISON / KOMBINATION	A mm	B mm
P7575	T61	X + X	655	385
P7576	T71	X + Y	770	385
P7577	T81	Y + Y	875	385
P7578	T91	X + X + X	985	385
P7579	T101	Y + X + X	1095	385
P7580	T111	Y + Y + X	1205	385
P7581	T131	Y + Y + Y	1315	385
P7582	T141	Y + X + X + X	1420	385
P7583	T151	Y + Y + X + X	1530	385
P7584	T161	Y + Y + Y + X	1645	385

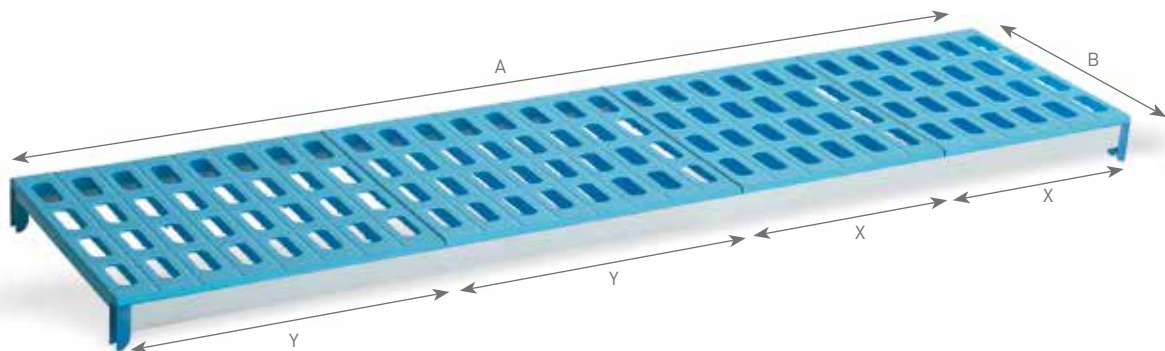

Fondo 555 mm. Adaptable a las cubetas gastronorm 1/1  
 Depth 555 mm. Suitable for 1/1 gastronorm containers  
 Profondeur 555 mm. Adaptable aux bacs gastronorme 1/1  
 Tiefe 555 mm. Passend für Gastronormbehälter 1/1

X significa una parrilla de ancho 325 mm.  
 Y significa una parrilla de ancho 435 mm.

X is a rack 325 mm width.  
 Y is a rack 435 mm width.

X est une clayette de 325 mm de largeur.  
 Y est une clayette de 435 mm de largeur.

X Bezeichnet einen Einlegeboden der Breite von 325 mm.  
 Y Bezeichnet einen Gitterboden der Breite von 435 mm.

REF	MOD	COMBINACIÓN / COMBINATION / COMBINAISON / KOMBINATION	A mm	B mm
P7565	T6	X + X	655	555
P7566	T7	X + Y	770	555
P7567	T8	Y + Y	875	555
P7568	T9	X + X + X	985	555
P7569	T10	Y + X + X	1095	555
P7570	T11	Y + Y + X	1205	555
P7571	T13	Y + Y + Y	1315	555
P7572	T14	Y + X + X + X	1420	555
P7573	T15	Y + Y + X + X	1530	555
P7574	T16	Y + Y + Y + X	1645	555

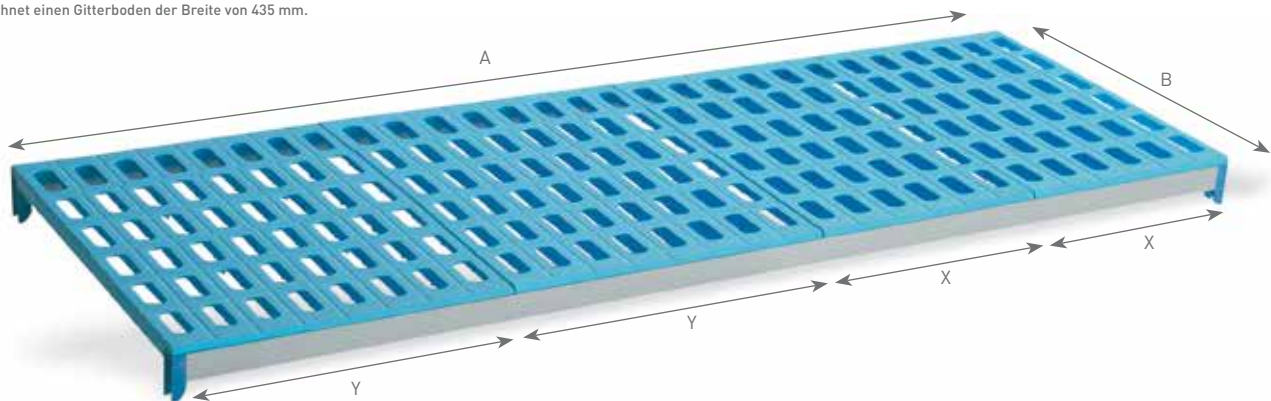



ESTANTES (PARRILLAS + TRAVESAÑOS) / SHELVES (RACK/SHELVES + CROSSBARS) / NIVEAU COMPLET (CLAYETTES + LONGERONS) / REGALE (GITTERBÖDEN + TRAVERSEN)

Soportes laterales / Lateral supports / Support latéraux / Seitliche Ständer

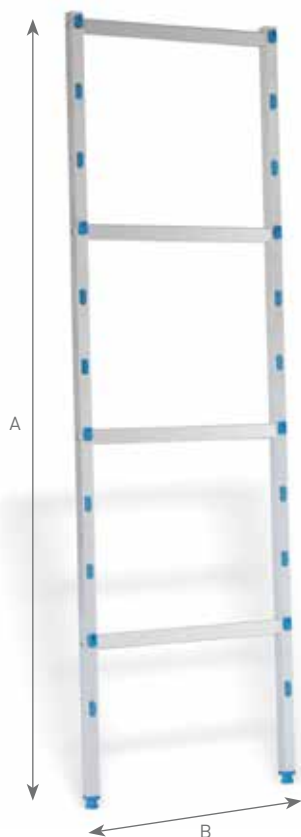

REF	MOD	A mm	B mm	NIVELES / LEVELS / NIVEAUX / EBENEN	U
P7585	S1	1750	555	3	1
P7586	S2	1750	555	4	1
P7587	S3	1750	555	5	1
P7646	S0	2000	555	4	1
P7588	S4	2000	555	5	1
P7589	S5	2000	555	6	1
P7590	S6	1300	555	3	1
P7591	S7	1750	385	3	1
P7592	S8	1750	385	4	1
P7593	S9	1750	385	5	1
P7647	S13	2000	385	4	1
P7594	S10	2000	385	5	1
P7595	S11	2000	385	6	1
P7596	S12	1300	385	3	1

2 Fondos disponibles :  
555 mm, gastronorm 1/1  
385 mm, gastronorm 2/3

2 Available depths:  
555 mm, 1/1 gastronorm  
385 mm, 2/3 gastronorm

2 profondeurs disponibles:  
555 mm, gastronorme 1/1  
385 mm, gastronorme 2/3

2 Tiefen erhältlich:  
555 mm, Gastronorm 1/1  
385 mm, Gastronorm 2/3

Soportes laterales con ruedas / Lateral support with wheels / Supports latéraux avec roues / Seitliche Ständer mit Räder

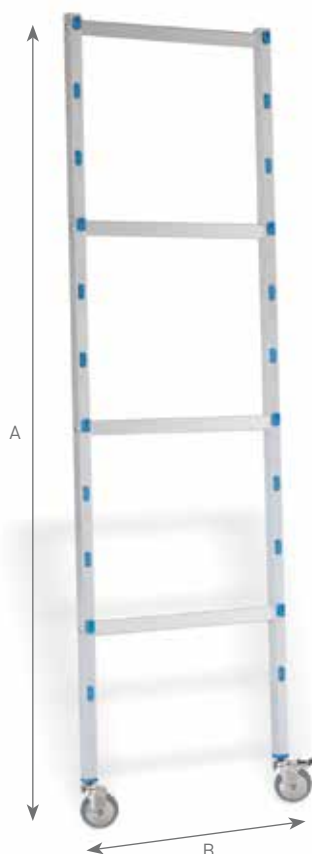

REF	A mm*	B mm	NIVELES / LEVELS / NIVEAUX / EBENEN	U
P7597	1880	555	3	1
P7598	1880	555	4	1
P7599	1880	555	5	1

Para montar estanterías móviles con ruedas.  
To assembly mobile shelving with wheels.  
Pour monter étagères mobiles avec roues.  
Für die Montage von mobilen Regalen mit Räder.

\* Altura con rueda incluida  
\* Height including wheel  
\* Hauteur avec la roue  
\* Höhe inklusive Räder

Ruedas de Ø 125 mm, dos de ellas con freno.  
Wheels Ø 125 mm, two of them with brake.  
Roues de Ø 125 mm, deux avec frein.  
Räder Ø 125 mm, zwei von ihnen mit Bremsen.

No se recomiendan longitudes de travesaños superiores a 1400 mm.  
We do not advise crossbars longer than 1400 mm.  
Nous ne conseillons pas des longerons plus longues de 1400 mm.  
Wir empfehlen nicht die Länge der Traversen von 1400 mm zu überschreiten.

## Travesaños / Crossbars / Longerons / Traversen



REF	L mm	U
P7632	655	1
P7633	770	1
P7634	875	1
P7635	985	1
P7636	1095	1
P7637	1205	1
P7638	1315	1
P7639	1420	1
P7640	1530	1
P7641	1645	1

## Parrillas / Rack-shelves / Clayettes / Einlegeböden

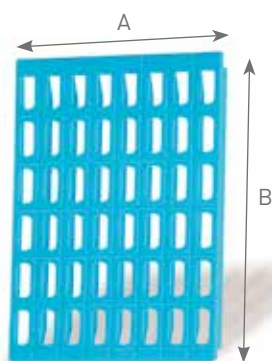

REF	TIPO / TYPE	A mm	B mm	GN Para / For / Pour / Für	U
P7628	Y	435	555	1/1	1
P7629	X	325	555	1/1	1
P7630	Y	435	385	2/3	1
P7631	X	325	385	2/3	1

## Ganchos para formar ángulos / Hooks to form angles / Crochets pour faire les angles / Haken für Winkelbildung



REF	U
P7642	1

Permiten el montaje de los ángulos por lo que se ahorran soportes laterales y se aprovecha al máximo el espacio.  
 With these hooks it is possible to form angles so you will not need lateral supports and will save the maximum space as possible.  
 Pour le montage des angles avec un maximum profit de place.  
 Diese Haken erlauben es Winkel zu montieren ohne den Gebrauch zusätzlicher Seitenständer, um so den maximalen Raum auszunutzen.

## Pieza soporte para travesaños / Support for crossbars / Support pour largerons / Halterteil für Traversen



REF	U
P7643	1

Esta pieza es necesaria para ampliar el número de niveles estándares en las referencias del catálogo.  
 This piece is necessary to increase the number of standard levels from the catalogue's references.  
 Cette pièce est nécessaire pour augmenter le nombre de niveaux standards des références du catalogue.  
 Dieses Teil ist nötig, um die Standardanzahl der Regalebene, im Katalog aufgelistet, zu erhöhen.

**Bancadas / Bench / BanCS / Bänke**

Diseñadas para su uso en lugares donde se prohíbe depositar cajas directamente en el suelo. Capacidad de carga de hasta 175 Kg por bancada, repartidos a lo largo de la bancada. Pie regulable para suelos desnivelados.

Designed to be used in places where it is forbidden to put boxes directly on the floor. Maximum load charge 175 Kg per bench, distributed weight throughout the bench. Leveling feet for gradient floors.

Dessinés pour être utilisés quand il est interdit de poser les boîtes directement par terre. Charge maximale 175 Kg, distribués tout au long du banc. Pieds réglateurs pour sols inégaux.

Design für den Gebrauch in Räumen, in denen es verboten ist Kisten direkt auf den Boden zu stellen. Die Tragkraft beträgt bis zu 175 Kg pro Bank, wenn die Last gleichmäßig auf der Länge verteilt ist. Regulierbare Füße für unebene Böden.

REF	A mm	B mm	C mm	U
P7603	715	555	280	1
P7604	830	555	280	1
P7605	935	555	280	1
P7606	1045	555	280	1
P7607	1155	555	280	1
P7608	1265	555	280	1
P7609	1375	555	280	1
P7610	1480	555	280	1
P7611	715	385	280	1
P7612	830	385	280	1
P7613	935	385	280	1
P7614	1045	385	280	1
P7615	1155	385	280	1
P7616	1260	385	280	1
P7617	1375	385	280	1
P7618	1480	385	280	1

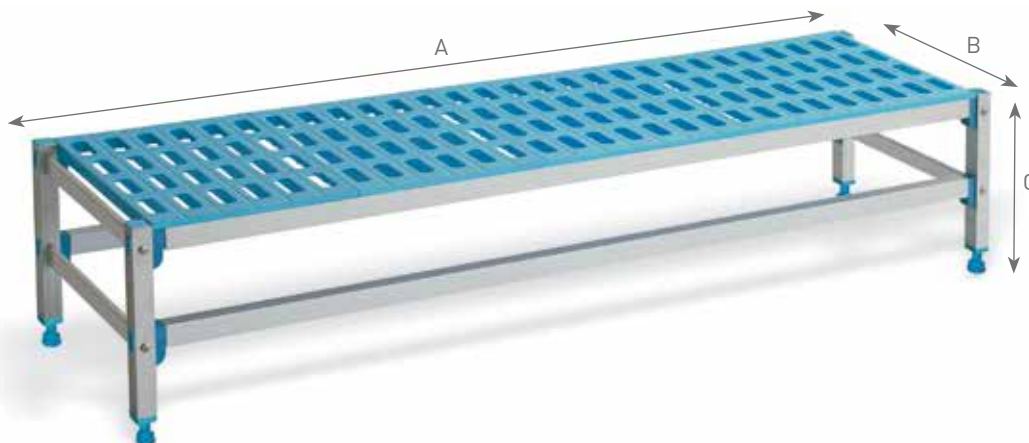

**Conjunto completo con ruedas / Complet kits with wheels / Kit préparés avec roues / Komplettes Set mit Rädern**

REF	A mm	B mm	C mm	TIPO / TYPE	NIVELES / LEVELS / NIVEAUX / EBENEN	U
P7145R	1145	555	1880	GN 1/1	3	1
P7004R	1145	385	1880	GN 2/3	3	1
P7146R	1265	555	1880	GN 1/1	3	1
P7005R	1265	385	1880	GN 2/3	3	1
P7147R	1375	555	1880	GN 1/1	3	1
P7006R	1375	385	1880	GN 2/3	3	1



Reforzada / Reinforced / Renforcée / Verstärkte

TRANSPORTE Y ALMACENAMIENTO / TRANSPORT & STORAGE / TRANSPORT ET STOCKAGE

**3** NIVELES /  
LEVELS /  
NIVEAUX /  
EBENEN

Kits completos / Complete kits / Kits préparés / Komplettssets

Distintas combinaciones /  
Diferent combinations /  
Diferentes combinaisons /  
Verschiedene Kombinationen

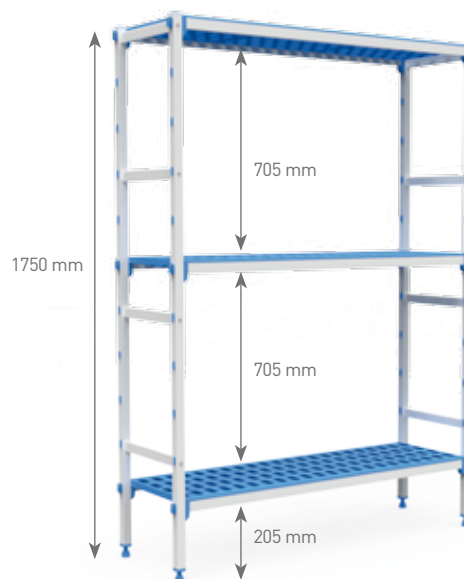

Compatible con cubetas 2/3 /  
Compatible with 2/3 containers /  
Compatible avec bacs 2/3 /  
Kombinierbar mit Behältern 2/3

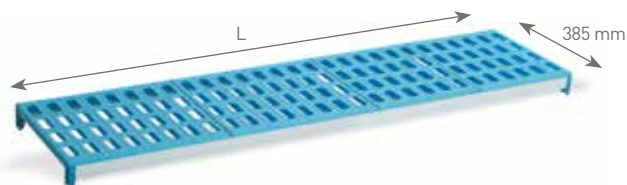

Compatible con cubetas 1/1 /  
Compatible with 1/1 containers /  
Compatible avec bacs 1/1 /  
Kombinierbar mit Behältern 1/1

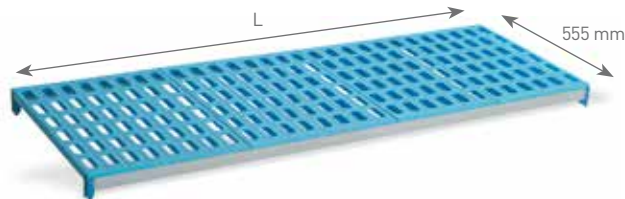

REF	L mm	REF	L mm
P7000	715	P7024	3380
P7001	830	P7025	3513
P7002	935	P7026	3621
P7003	1045	P7027	3729
P7004	1155	P7028	3841
P7005	1265	P7029	3953
P7006	1375	P7030	4065
P7007	1480	P7031	4170
P7008	1590	P7032	4275
P7009	1705	P7033	4380
P7010	1840	P7034	4490
P7011	1950	P7035	4600
P7012	2060	P7036	4710
P7013	2170	P7037	4825
P7014	2280	P7038	4940
P7015	2388	P7039	5055
P7016	2496	P7040	5186
P7017	2608	P7041	5298
P7018	2720	P7042	5410
P7019	2825	P7043	5515
P7020	2930	P7044	5620
P7021	3040	P7045	5725
P7022	3150	P7046	5830
P7023	3265		

REF	L mm	REF	L mm
P7141	715	P7165	3380
P7142	830	P7166	3513
P7143	935	P7167	3621
P7144	1045	P7168	3729
P7145	1155	P7169	3841
P7146	1263	P7170	3953
P7147	1375	P7171	4065
P7148	1480	P7172	4170
P7149	1590	P7173	4275
P7150	1705	P7174	4380
P7151	1840	P7175	4490
P7152	1950	P7176	4600
P7153	2060	P7177	4710
P7154	2170	P7178	4825
P7155	2280	P7179	4940
P7156	2388	P7180	5055
P7157	2496	P7181	5186
P7158	2608	P7182	5298
P7159	2720	P7183	5410
P7160	2825	P7184	5515
P7161	2930	P7185	5620
P7162	3040	P7186	5725
P7163	3150	P7187	5830
P7164	3265		



**3** NIVELES /  
LEVELS /  
NIVEAUX /  
EBENEN

Estanterías angulares / Shelvings for angle / Étagères angulaires / Rechtwinklige Regale

Distintas combinaciones /  
Diferent combinations /  
Diferentes combinaisons /  
Verschiedene Kombinationen



Incluido / Included / Compris / Inklusive:  
Ganchos para formar ángulos /  
Hooks to form angles /  
Crochets pour faire les angles /  
Haken für Winkelbildung



Compatible con cubetas 2/3 /  
Compatible with 2/3 containers /  
Compatible avec bacs 2/3 /  
Kombinierbar mit Behältern 2/3

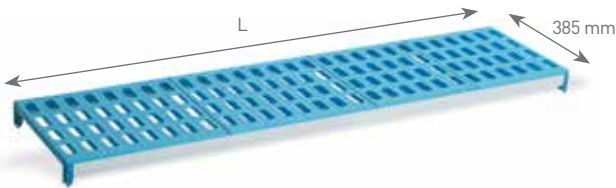

Compatible con cubetas 1/1 /  
Compatible with 1/1 containers /  
Compatible avec bacs 1/1 /  
Kombinierbar mit Behältern 1/1



REF	L mm	REF	L mm
P7282	685	P7306	3350
P7283	800	P7307	3483
P7284	905	P7308	3591
P7285	1015	P7309	3699
P7286	1125	P7310	3811
P7287	1233	P7311	3923
P7288	1345	P7312	4035
P7289	1450	P7313	4140
P7290	1560	P7314	4245
P7291	1675	P7315	4350
P7292	1810	P7316	4460
P7293	1920	P7317	4570
P7294	2030	P7318	4680
P7295	2140	P7319	4795
P7296	2250	P7320	4910
P7297	2358	P7321	5025
P7298	2466	P7322	5156
P7299	2578	P7323	5268
P7300	2690	P7324	5380
P7301	2795	P7325	5485
P7302	2900	P7326	5590
P7303	3010	P7327	5695
P7304	3120	P7328	5800
P7305	3235		

REF	L mm	REF	L mm
P7423	685	P7447	3350
P7424	800	P7448	3483
P7425	905	P7449	3591
P7426	1015	P7450	3699
P7427	1125	P7451	3811
P7428	1233	P7452	3923
P7429	1345	P7453	4035
P7430	1450	P7454	4140
P7431	1560	P7455	4245
P7432	1675	P7456	4350
P7433	1810	P7457	4460
P7434	1920	P7458	4570
P7435	2030	P7459	4680
P7436	2140	P7460	4795
P7437	2250	P7461	4910
P7438	2358	P7462	5025
P7439	2466	P7463	5156
P7440	2578	P7464	5268
P7441	2690	P7465	5380
P7442	2795	P7466	5485
P7443	2900	P7467	5590
P7444	3010	P7468	5695
P7445	3120	P7469	5800
P7446	3235		

TRANSPORTE Y ALMACENAMIENTO /  
TRANSPORT & STORAGE /  
TRANSPORT ET STOCKAGE

**4** NIVELES /  
LEVELS /  
NIVEAUX /  
EBENEN

Kits completos / Complete kits / Kits préparés / Komplettssets

Distintas combinaciones /  
Diferent combinations /  
Diferentes combinaisons /  
Verschiedene Kombinationen



Compatible con cubetas 2/3 /  
Compatible with 2/3 containers /  
Compatible avec bacs 2/3 /  
Kombinierbar mit Behältern 2/3

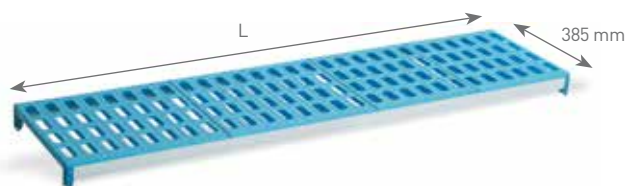

Compatible con cubetas 1/1 /  
Compatible with 1/1 containers /  
Compatible avec bacs 1/1 /  
Kombinierbar mit Behältern 1/1

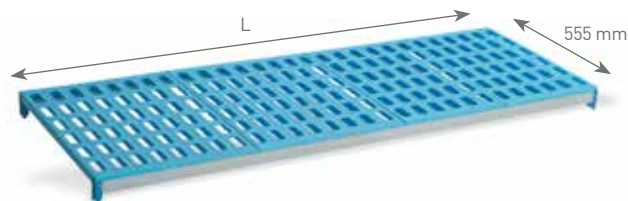

REF	L mm	REF	L mm
P7047	715	P7071	3380
P7048	830	P7072	3513
P7049	935	P7073	3621
P7050	1045	P7074	3729
P7051	1155	P7075	3841
P7052	1263	P7076	3953
P7053	1375	P7077	4065
P7054	1480	P7078	4170
P7055	1590	P7079	4275
P7056	1705	P7080	4380
P7057	1840	P7081	4490
P7058	1950	P7082	4600
P7059	2060	P7083	4710
P7060	2170	P7084	4825
P7061	2280	P7085	4940
P7062	2388	P7086	5055
P7063	2496	P7087	5186
P7064	2608	P7088	5298
P7065	2720	P7089	5410
P7066	2825	P7090	5515
P7067	2930	P7091	5620
P7068	3040	P7092	5725
P7069	3150	P7093	5830
P7070	3265		

REF	L mm	REF	L mm
P7188	715	P7212	3380
P7189	830	P7213	3513
P7190	935	P7214	3621
P7191	1045	P7215	3729
P7192	1155	P7216	3841
P7193	1263	P7217	3953
P7194	1375	P7218	4065
P7195	1480	P7219	4170
P7196	1590	P7220	4275
P7197	1705	P7221	4380
P7198	1840	P7222	4490
P7199	1950	P7223	4600
P7200	2060	P7224	4710
P7201	2170	P7225	4825
P7202	2280	P7226	4940
P7203	2388	P7227	5055
P7204	2496	P7228	5186
P7205	2608	P7229	5298
P7206	2720	P7230	5410
P7207	2825	P7231	5515
P7208	2930	P7232	5620
P7209	3040	P7233	5725
P7210	3150	P7234	5830
P7211	3265		

**4** NIVELES / LEVELS / NIVEAUX / EBEBEN

Estanterías angulares / Shelvings for angle / Étagères angulaires / Rechtwinklige Regale

Distintas combinaciones /  
Diferent combinations /  
Diferentes combinaisons /  
Verschiedene Kombinationen



Incluido / Included / Compris / Inklusive:  
Ganchos para formar ángulos /  
Hooks to form angles /  
Crochets pour faire les angles /  
Haken für Winkelbildung

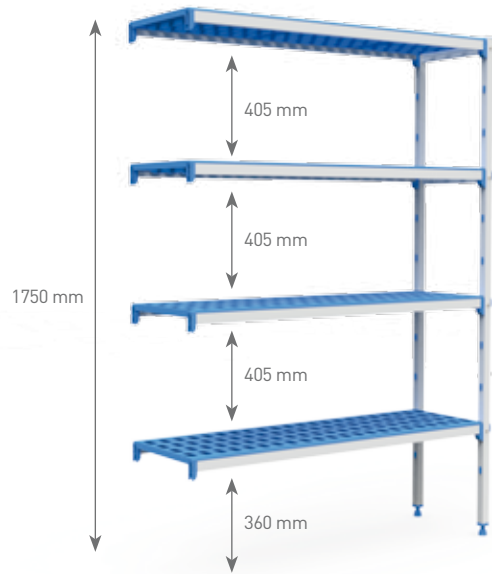

Compatible con cubetas 2/3 /  
Compatible with 2/3 containers /  
Compatible avec bacs 2/3 /  
Kombinierbar mit Behältern 2/3

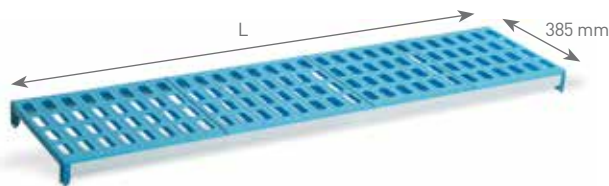

Compatible con cubetas 1/1 /  
Compatible with 1/1 containers /  
Compatible avec bacs 1/1 /  
Kombinierbar mit Behältern 1/1

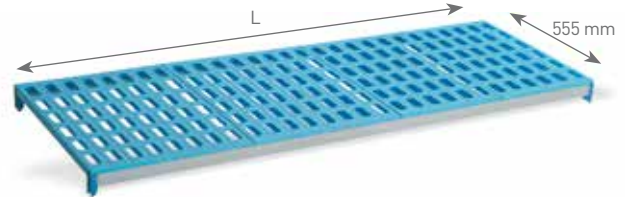

REF	L mm	REF	L mm
P7329	685	P7353	3350
P7330	800	P7354	3483
P7331	905	P7355	3591
P7332	1015	P7356	3699
P7333	1125	P7357	3811
P7334	1233	P7358	3923
P7335	1345	P7359	4035
P7336	1450	P7360	4140
P7337	1560	P7361	4245
P7338	1675	P7362	4350
P7339	1810	P7363	4460
P7340	1920	P7364	4570
P7341	2030	P7365	4680
P7342	2140	P7366	4795
P7343	2250	P7367	4910
P7344	2358	P7368	5025
P7345	2466	P7369	5156
P7346	2578	P7370	5268
P7347	2690	P7371	5380
P7348	2795	P7372	5485
P7349	2900	P7373	5590
P7350	3010	P7374	5695
P7351	3120	P7375	5800
P7352	3235		

REF	L mm	REF	L mm
P7470	685	P7494	3350
P7471	800	P7495	3483
P7472	905	P7496	3591
P7473	1015	P7497	3699
P7474	1125	P7498	3811
P7475	1233	P7499	3923
P7476	1345	P7500	4035
P7477	1450	P7501	4140
P7478	1560	P7502	4245
P7479	1675	P7503	4350
P7480	1810	P7504	4460
P7481	1920	P7505	4570
P7482	2030	P7506	4680
P7483	2140	P7507	4795
P7484	2250	P7508	4910
P7485	2358	P7509	5025
P7486	2466	P7510	5156
P7487	2578	P7511	5268
P7488	2690	P7512	5380
P7489	2795	P7513	5485
P7490	2900	P7514	5590
P7491	3010	P7515	5695
P7492	3120		
P7493	3235		

TRANSPORTE Y ALMACENAMIENTO /  
TRANSPORT & STORAGE /  
TRANSPORT ET STOCKAGE

## ESTANTERÍA COMPLETA / FULL SHELF / ÉTAGÈRE PLEINE

**5** NIVELES /  
LEVELS /  
NIVEAUX /  
EBENEN

Kits completos / Complete kits / Kits préparés / Komplettssets

Distintas combinaciones /  
Diferent combinations /  
Diferentes combinaisons /  
Verschiedene Kombinationen



Compatible con cubetas 2/3 /  
Compatible with 2/3 containers /  
Compatible avec bacs 2/3 /  
Kombinierbar mit Behältern 2/3

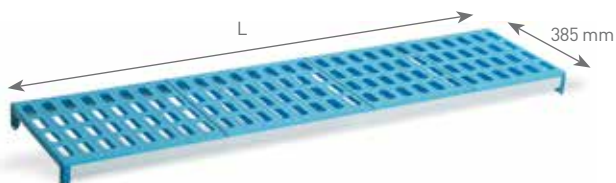

Compatible con cubetas 1/1 /  
Compatible with 1/1 containers /  
Compatible avec bacs 1/1 /  
Kombinierbar mit Behältern 1/1

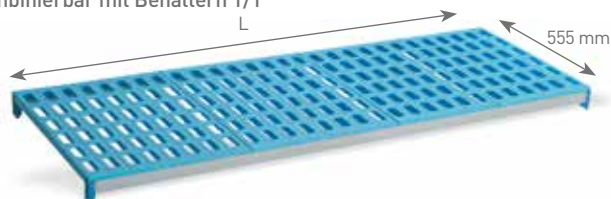

REF	L mm	REF	L mm
P7094	715	P7118	3380
P7095	830	P7119	3513
P7096	935	P7120	3621
P7097	1045	P7121	3729
P7098	1155	P7122	3841
P7099	1263	P7123	3953
P7100	1375	P7124	4065
P7101	1480	P7125	4170
P7102	1590	P7126	4275
P7103	1705	P7127	4380
P7104	1840	P7128	4490
P7105	1950	P7129	4600
P7106	2060	P7130	4710
P7107	2170	P7131	4825
P7108	2280	P7132	4940
P7109	2388	P7133	5055
P7110	2496	P7134	5186
P7111	2608	P7135	5298
P7112	2720	P7136	5410
P7113	2825	P7137	5515
P7114	2930	P7138	5620
P7115	3040	P7139	5725
P7116	3150	P7140	5830
P7117	3265		

REF	L mm	REF	L mm
P7235	715	P7259	3380
P7236	830	P7260	3513
P7237	935	P7261	3621
P7238	1045	P7262	3729
P7239	1155	P7263	3841
P7240	1263	P7264	3953
P7241	1375	P7265	4065
P7242	1480	P7266	4170
P7243	1590	P7267	4275
P7244	1705	P7268	4380
P7245	1840	P7269	4490
P7246	1950	P7270	4600
P7247	2060	P7271	4710
P7248	2170	P7272	4825
P7249	2280	P7273	4940
P7250	2388	P7274	5055
P7251	2496	P7275	5186
P7252	2608	P7276	5298
P7253	2720	P7277	5410
P7254	2825	P7278	5515
P7255	2930	P7279	5620
P7256	3040	P7280	5725
P7257	3150	P7281	5830
P7258	3265		



**5** NIVELES /  
LEVELS /  
NIVEAUX /  
EBENEN

Estanterías angulares / Shelvings for angle / Étagères angulaires / Rechtwinklige Regale

Distintas combinaciones /  
Diferent combinations /  
Diferentes combinaisons /  
Verschiedene Kombinationen



Incluido / Included / Compris / Inklusive:  
Ganchos para formar ángulos /  
Hooks to form angles /  
Crochets pour faire les angles /  
Haken für Winkelbildung

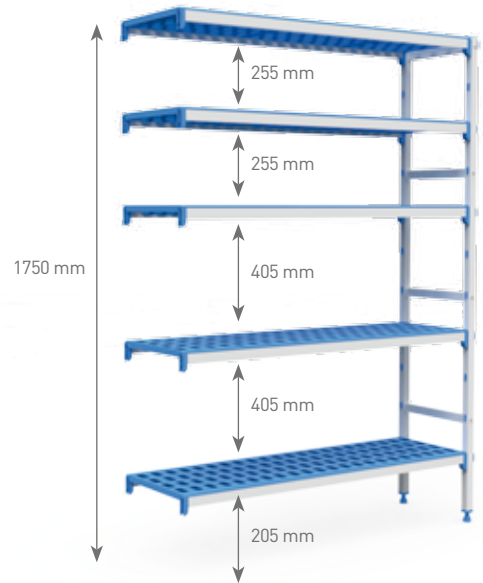

Compatible con cubetas 2/3 /  
Compatible with 2/3 containers /  
Compatible avec bacs 2/3 /  
Kombinierbar mit Behältern 2/3

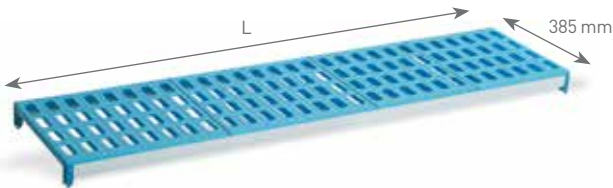

Compatible con cubetas 1/1 /  
Compatible with 1/1 containers /  
Compatible avec bacs 1/1 /  
Kombinierbar mit Behältern 1/1

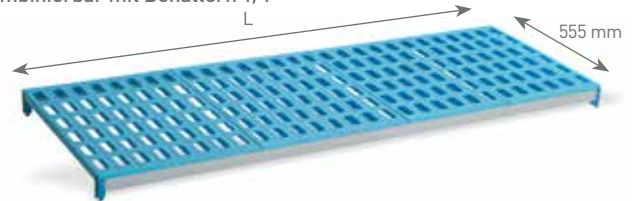

REF	L mm	REF	L mm
P7376	685	P7400	3350
P7377	800	P7401	3483
P7378	905	P7402	3591
P7379	1015	P7403	3699
P7380	1125	P7404	3811
P7381	1233	P7405	3923
P7382	1345	P7406	4035
P7383	1450	P7407	4140
P7384	1560	P7408	4245
P7385	1675	P7409	4350
P7386	1810	P7410	4460
P7387	1920	P7411	4570
P7388	2030	P7412	4680
P7389	2140	P7413	4795
P7390	2250	P7414	4910
P7391	2358	P7415	5025
P7392	2466	P7416	5156
P7393	2578	P7417	5268
P7394	2690	P7418	5380
P7395	2795	P7419	5485
P7396	2900	P7420	5590
P7397	3010	P7421	5695
P7398	3120	P7422	5800
P7399	3235		

REF	L mm	REF	L mm
P7517	685	P7541	3350
P7518	800	P7542	3483
P7519	905	P7543	3591
P7520	1015	P7544	3699
P7521	1125	P7545	3811
P7522	1233	P7546	3923
P7523	1345	P7547	4035
P7524	1450	P7548	4140
P7525	1560	P7549	4245
P7526	1675	P7550	4350
P7527	1810	P7551	4460
P7528	1920	P7552	4570
P7529	2030	P7553	4680
P7530	2140	P7554	4795
P7531	2250	P7555	4910
P7532	2358	P7556	5025
P7533	2466	P7557	5156
P7534	2578	P7558	5268
P7535	2690	P7559	5380
P7536	2795	P7560	5485
P7537	2900	P7561	5590
P7538	3010	P7562	5695
P7539	3120		
P7540	3235		

TRANSPORTE Y ALMACENAMIENTO /  
TRANSPORT & STORAGE /  
TRANSPORT ET STOCKAGE

## DESGLOSE CONJUNTOS DE ESTANTERÍAS / BREAKDOWN OF SHELVING SETS / SETS DES ÉTAGÈRES / AUFLISTUNGSÜBERSICHT DER REGALSETS

FONDO 385 mm. Adaptable a GASTRONORM 2/3 / DEEPth 385 mm. Suitable for 2/3 GASTRONORM / PROFONDEUR 385 mm. Adaptable aux GASTRONORME 2/3 / Tiefe 385 mm. Passend für Gastronorm 2/3

REF. 3 niveles 3 levels 3 niveaux 3 Ebenen	DESGLOSE BREAKDOWN COMPOSITION AUFLISTUNG	REF. 4 niveles 4 levels 4 niveaux 4 Ebenen	DESGLOSE BREAKDOWN COMPOSITION AUFLISTUNG	REF. 5 niveles 5 levels 5 niveaux 5 Ebenen	DESGLOSE BREAKDOWN COMPOSITION AUFLISTUNG
P7000	2 S7 + 3 T61	P7047	2 S8 + 4 T61	P7094	2 S9 + 5 T61
P7001	2 S7 + 3 T71	P7048	2 S8 + 4 T71	P7095	2 S9 + 5 T71
P7002	2 S7 + 3 T81	P7049	2 S8 + 4 T81	P7096	2 S9 + 5 T81
P7003	2 S7 + 3 T91	P7050	2 S8 + 4 T91	P7097	2 S9 + 5 T91
P7004	2 S7 + 3 T101	P7051	2 S8 + 4 T101	P7098	2 S9 + 5 T101
P7005	2 S7 + 3 T111	P7052	2 S8 + 4 T111	P7099	2 S9 + 5 T111
P7006	2 S7 + 3 T131	P7053	2 S8 + 4 T131	P7100	2 S9 + 5 T131
P7007	2 S7 + 3 T141	P7054	2 S8 + 4 T141	P7101	2 S9 + 5 T141
P7008	2 S7 + 3 T151	P7055	2 S8 + 4 T151	P7102	2 S9 + 5 T151
P7009	2 S7 + 3 T161	P7056	2 S8 + 4 T161	P7103	2 S9 + 5 T161
P7010	3 S7 + 6 T81	P7057	3 S8 + 8 T81	P7104	3 S9 + 10 T81
P7011	3 S7 + 3 T81 + 3 T91	P7058	3 S8 + 4 T81 + 4 T91	P7105	3 S9 + 5 T81 + 5 T91
P7012	3 S7 + 6 T91	P7059	3 S8 + 8 T91	P7106	3 S9 + 10 T91
P7013	3 S7 + 3 T91 + 3 T101	P7060	3 S8 + 4 T91 + 4 T101	P7107	3 S9 + 5 T91 + 5 T101
P7014	3 S7 + 6 T101	P7061	3 S8 + 8 T101	P7108	3 S9 + 10 T101
P7015	3 S7 + 3 T101 + 3 T111	P7062	3 S8 + 4 T101 + 4 T111	P7109	3 S9 + 5 T101 + 5 T111
P7016	3 S7 + 6 T111	P7063	3 S8 + 8 T111	P7110	3 S9 + 10 T111
P7017	3 S7 + 3 T111 + 3 T131	P7064	3 S8 + 4 T111 + 4 T131	P7111	3 S9 + 5 T111 + 5 T131
P7018	3 S7 + 6 T131	P7065	3 S8 + 8 T131	P7112	3 S9 + 10 T131
P7019	3 S7 + 3 T131 + 3 T141	P7066	3 S8 + 4 T131 + 4 T141	P7113	3 S9 + 5 T131 + 5 T141
P7020	3 S7 + 6 T141	P7067	3 S8 + 8 T141	P7114	3 S9 + 10 T141
P7021	3 S7 + 3 T141 + 3 T151	P7068	3 S8 + 4 T141 + 4 T151	P7115	3 S9 + 5 T141 + 5 T151
P7022	3 S7 + 6 T151	P7069	3 S8 + 8 T151	P7116	3 S9 + 10 T151
P7023	3 S7 + 3 T151 + 3 T161	P7070	3 S8 + 4 T151 + 4 T161	P7117	3 S9 + 5 T151 + 5 T161
P7024	3 S7 + 6 T161	P7071	3 S8 + 8 T161	P7118	3 S9 + 10 T161
P7025	4 S7 + 6 T101 + 3 T111	P7072	4 S8 + 8 T101 + 4 T111	P7119	4 S9 + 10 T101 + 5 T111
P7026	4 S7 + 3 T101 + 6 T111	P7073	4 S8 + 4 T101 + 8 T111	P7120	4 S9 + 5 T101 + 10 T111
P7027	4 S7 + 9 T111	P7074	4 S8 + 12 T111	P7121	4 S9 + 15 T111
P7028	4 S7 + 6 T111 + 3 T131	P7075	4 S8 + 8 T111 + 4 T131	P7122	4 S9 + 10 T111 + 5 T131
P7029	4 S7 + 3 T111 + 6 T131	P7076	4 S8 + 4 T111 + 8 T131	P7123	4 S9 + 5 T111 + 10 T131
P7030	4 S7 + 9 T131	P7077	4 S8 + 12 T131	P7124	4 S9 + 15 T131
P7031	4 S7 + 6 T131 + 3 T141	P7078	4 S8 + 8 T131 + 4 T141	P7125	4 S9 + 10 T131 + 5 T141
P7032	4 S7 + 3 T131 + 6 T141	P7079	4 S8 + 4 T131 + 8 T141	P7126	4 S9 + 5 T131 + 10 T141
P7033	4 S7 + 9 T141	P7080	4 S8 + 12 T141	P7127	4 S9 + 15 T141
P7034	4 S7 + 6 T141 + 3 T151	P7081	4 S8 + 8 T141 + 4 T151	P7128	4 S9 + 10 T141 + 5 T151
P7035	4 S7 + 3 T141 + 6 T151	P7082	4 S8 + 4 T141 + 8 T151	P7129	4 S9 + 5 T141 + 10 T151
P7036	4 S7 + 9 T151	P7083	4 S8 + 12 T151	P7130	4 S9 + 15 T151
P7037	4 S7 + 6 T151 + 3 T161	P7084	4 S8 + 8 T151 + 4 T161	P7131	4 S9 + 10 T151 + 5 T161
P7038	4 S7 + 3 T151 + 6 T161	P7085	4 S8 + 4 T151 + 8 T161	P7132	4 S9 + 5 T151 + 10 T161
P7039	4 S7 + 9 T161	P7086	4 S8 + 12 T161	P7133	4 S9 + 15 T161
P7040	5 S7 + 6 T111 + 6 T131	P7087	5 S8 + 8 T111 + 8 T131	P7134	5 S9 + 10 T111 + 10 T131
P7041	5 S7 + 3 T111 + 9 T131	P7088	5 S8 + 4 T111 + 12 T131	P7135	5 S9 + 5 T111 + 15 T131
P7042	5 S7 + 12 T131	P7089	5 S8 + 16 T131	P7136	5 S9 + 20 T131
P7043	5 S7 + 3 T141 + 9 T131	P7090	5 S8 + 4 T141 + 12 T131	P7137	5 S9 + 5 T141 + 15 T131
P7044	5 S7 + 6 T131 + 6 T141	P7091	5 S8 + 8 T131 + 8 T141	P7138	5 S9 + 10 T131 + 10 T141
P7045	5 S7 + 3 T131 + 9 T141	P7092	5 S8 + 4 T131 + 12 T141	P7139	5 S9 + 5 T131 + 15 T141
P7046	5 S7 + 12 T141	P7093	5 S8 + 16 T141	P7140	5 S9 + 20 T141

DESGLASE CONJUNTOS DE ESTANTERÍAS / BREAKDOWN OF SHELVING SETS / SETS DES ÉTAGÈRES / AUFLISTUNGSÜBERSICHT DER REGALSETS

FONDO 555 mm. Adaptable a GASTRONORM 1/1 / DEEPH 555 mm. Suitable for 1/1 GASTRONORM / PROFONDEUR 555 mm. Adaptable aux GASTRONORME 1/1 / Tiefe 555 mm. Passend für Gastronorm 1/1

REF. 3 niveles 3 levels 3 niveaux 3 Ebenen	DESGLASE BREAKDOWN COMPOSITION AUFLISTUNG
P7141	2 S1 + 3 T6
P7142	2 S1 + 3 T7
P7143	2 S1 + 3 T8
P7144	2 S1 + 3 T9
P7145	2 S1 + 3 T10
P7146	2 S1 + 3 T11
P7147	2 S1 + 3 T13
P7148	2 S1 + 3 T14
P7149	2 S1 + 3 T15
P7150	2 S1 + 3 T16
P7151	3 S1 + 6 T8
P7152	3 S1 + 3 T8 + 3 T9
P7153	3 S1 + 6 T9
P7154	3 S1 + 3 T9 + 3 T10
P7155	3 S1 + 6 T10
P7156	3 S1 + 3 T10 + 3 T11
P7157	3 S1 + 6 T11
P7158	3 S1 + 3 T11 + 3 T13
P7159	3 S1 + 6 T13
P7160	3 S1 + 3 T13 + 3 T14
P7161	3 S1 + 6 T14
P7162	3 S1 + 3 T14 + 3 T15
P7163	3 S1 + 6 T15
P7164	3 S1 + 3 T15 + 3 T16
P7165	3 S1 + 6 T16
P7166	4 S1 + 6 T10 + 3 T11
P7167	4 S1 + 3 T10 + 6 T11
P7168	4 S1 + 9 T11
P7169	4 S1 + 6 T11 + 3 T13
P7170	4 S1 + 3 T11 + 6 T13
P7171	4 S1 + 9 T13
P7172	4 S1 + 6 T13 + 3 T14
P7173	4 S1 + 3 T13 + 6 T14
P7174	4 S1 + 9 T14
P7175	4 S1 + 6 T14 + 3 T15
P7176	4 S1 + 3 T14 + 6 T15
P7177	4 S1 + 9 T15
P7178	4 S1 + 6 T15 + 3 T16
P7179	4 S1 + 3 T15 + 6 T16
P7180	4 S1 + 9 T16
P7181	5 S1 + 6 T11 + 6 T13
P7182	5 S1 + 3 T11 + 9 T13
P7183	5 S1 + 12 T13
P7184	5 S1 + 3 T14 + 9 T13
P7185	5 S1 + 6 T13 + 6 T14
P7186	5 S1 + 3 T13 + 9 T14
P7187	5 S1 + 12 T14

REF. 4 niveles 4 levels 4 niveaux 4 Ebenen	DESGLASE BREAKDOWN COMPOSITION AUFLISTUNG
P7188	2 S2 + 4 T6
P7189	2 S2 + 4 T7
P7190	2 S2 + 4 T8
P7191	2 S2 + 4 T9
P7192	2 S2 + 4 T10
P7193	2 S2 + 4 T11
P7194	2 S2 + 4 T13
P7195	2 S2 + 4 T14
P7196	2 S2 + 4 T15
P7197	2 S2 + 4 T16
P7198	3 S2 + 8 T8
P7199	3 S2 + 4 T8 + 4 T9
P7200	3 S2 + 8 T9
P7201	3 S2 + 4 T9 + 4 T10
P7202	3 S2 + 8 T10
P7203	3 S2 + 4 T10 + 4 T11
P7204	3 S2 + 8 T11
P7205	3 S2 + 4 T11 + 4 T13
P7206	3 S2 + 8 T13
P7207	3 S2 + 4 T13 + 4 T14
P7208	3 S2 + 8 T14
P7209	3 S2 + 4 T14 + 4 T15
P7210	3 S2 + 8 T15
P7211	3 S2 + 4 T15 + 4 T16
P7212	3 S2 + 8 T16
P7213	4 S2 + 8 T10 + 4 T11
P7214	4 S2 + 4 T10 + 8 T11
P7215	4 S2 + 12 T11
P7216	4 S2 + 8 T11 + 4 T13
P7217	4 S2 + 4 T11 + 8 T13
P7218	4 S2 + 12 T13
P7219	4 S2 + 8 T13 + 4 T14
P7220	4 S2 + 4 T13 + 8 T14
P7221	4 S2 + 12 T14
P7222	4 S2 + 8 T14 + 4 T15
P7223	4 S2 + 4 T14 + 8 T15
P7224	4 S2 + 12 T15
P7225	4 S2 + 8 T15 + 4 T16
P7226	4 S2 + 4 T15 + 8 T16
P7227	4 S2 + 12 T16
P7228	5 S2 + 8 T11 + 8 T13
P7229	5 S2 + 4 T11 + 12 T13
P7230	5 S2 + 16 T13
P7231	5 S2 + 4 T14 + 12 T13
P7232	5 S2 + 8 T13 + 8 T14
P7233	5 S2 + 4 T13 + 12 T14
P7234	5 S2 + 16 T14

REF. 5 niveles 5 levels 5 niveaux 5 Ebenen	DESGLASE BREAKDOWN COMPOSITION AUFLISTUNG
P7235	2 S3 + 5 T6
P7236	2 S3 + 5 T7
P7237	2 S3 + 5 T8
P7238	2 S3 + 5 T9
P7239	2 S3 + 5 T10
P7240	2 S3 + 5 T11
P7241	2 S3 + 5 T13
P7242	2 S3 + 5 T14
P7243	2 S3 + 5 T15
P7244	2 S3 + 5 T16
P7245	3 S3 + 10 T8
P7246	3 S3 + 5 T8 + 5 T9
P7247	3 S3 + 10 T9
P7248	3 S3 + 5 T9 + 5 T10
P7249	3 S3 + 10 T10
P7250	3 S3 + 5 T10 + 5 T11
P7251	3 S3 + 10 T11
P7252	3 S3 + 5 T11 + 5 T13
P7253	3 S3 + 10 T13
P7254	3 S3 + 5 T13 + 5 T14
P7255	3 S3 + 10 T14
P7256	3 S3 + 5 T14 + 5 T15
P7257	3 S3 + 10 T15
P7258	3 S3 + 5 T15 + 5 T16
P7259	3 S3 + 10 T16
P7260	4 S3 + 10 T10 + 5 T11
P7261	4 S3 + 5 T10 + 10 T11
P7262	4 S3 + 15 T11
P7263	4 S3 + 10 T11 + 5 T13
P7264	4 S3 + 5 T11 + 10 T13
P7265	4 S3 + 15 T13
P7266	4 S3 + 10 T13 + 5 T14
P7267	4 S3 + 5 T13 + 10 T14
P7268	4 S3 + 15 T14
P7269	4 S3 + 10 T14 + 5 T15
P7270	4 S3 + 5 T14 + 10 T15
P7271	4 S3 + 15 T15
P7272	4 S3 + 10 T15 + 5 T16
P7273	4 S3 + 5 T15 + 10 T16
P7274	4 S3 + 15 T16
P7275	5 S3 + 10 T11 + 10 T13
P7276	5 S3 + 5 T11 + 15 T13
P7277	5 S3 + 20 T13
P7278	5 S3 + 5 T14 + 15 T13
P7279	5 S3 + 10 T13 + 10 T14
P7280	5 S3 + 5 T13 + 15 T14
P7281	5 S3 + 20 T14

TRANSPORTE Y ALMACENAMIENTO /  
TRANSPORT & STORAGE /  
TRANSPORT ET STOCKAGE

## DESGLOSE CONJUNTOS DE ESTANTERÍAS / BREAKDOWN OF SHELVING SETS / SETS DES ÉTAGÈRES / AUFLISTUNGSÜBERSICHT DER REGALSETS

FONDO 385 mm. Adaptable a GASTRONORM 2/3 / DEEPH 385 mm. Suitable for 2/3 GASTRONORM / PROFONDEUR 385 mm. Adaptable aux GASTRONORME 2/3 / Tiefe 385 mm. Passend für Gastronorm 2/3

REF. 3 niveles 3 niveaux 3 Ebenen	DESGLOSE BREAKDOWN COMPOSITION AUFLISTUNG	REF. 4 niveles 4 levels 4 niveaux 4 Ebenen	DESGLOSE BREAKDOWN COMPOSITION AUFLISTUNG	REF. 5 niveles 5 levels 5 niveaux 5 Ebenen	DESGLOSE BREAKDOWN COMPOSITION AUFLISTUNG
P7282	1 S7 + 3 T61	P7329	1 S8 + 4 T61	P7376	1 S9 + 5 T61
P7283	1 S7 + 3 T71	P7330	1 S8 + 4 T71	P7377	1 S9 + 5 T71
P7284	1 S7 + 3 T81	P7331	1 S8 + 4 T81	P7378	1 S9 + 5 T81
P7285	1 S7 + 3 T91	P7332	1 S8 + 4 T91	P7379	1 S9 + 5 T91
P7286	1 S7 + 3 T101	P7333	1 S8 + 4 T101	P7380	1 S9 + 5 T101
P7287	1 S7 + 3 T111	P7334	1 S8 + 4 T111	P7381	1 S9 + 5 T111
P7288	1 S7 + 3 T131	P7335	1 S8 + 4 T131	P7382	1 S9 + 5 T131
P7289	1 S7 + 3 T141	P7336	1 S8 + 4 T141	P7383	1 S9 + 5 T141
P7290	1 S7 + 3 T151	P7337	1 S8 + 4 T151	P7384	1 S9 + 5 T151
P7291	1 S7 + 3 T161	P7338	1 S8 + 4 T161	P7385	1 S9 + 5 T161
P7292	2 S7 + 6 T81	P7339	2 S8 + 8 T81	P7386	2 S9 + 10 T81
P7293	2 S7 + 3 T81 + 3 T91	P7340	2 S8 + 4 T81 + 4 T91	P7387	2 S9 + 5 T81 + 5 T91
P7294	2 S7 + 6 T91	P7341	2 S8 + 8 T91	P7388	2 S9 + 10 T91
P7295	2 S7 + 3 T91 + 3 T101	P7342	2 S8 + 4 T91 + 4 T101	P7389	2 S9 + 5 T91 + 5 T101
P7296	2 S7 + 6 T101	P7343	2 S8 + 8 T101	P7390	2 S9 + 10 T101
P7297	2 S7 + 3 T111 + 3 T111	P7344	2 S8 + 4 T101 + 4 T111	P7391	2 S9 + 5 T101 + 5 T111
P7298	2 S7 + 6 T111	P7345	2 S8 + 8 T111	P7392	2 S9 + 10 T111
P7299	2 S7 + 3 T111 + 3 T131	P7346	2 S8 + 4 T111 + 4 T131	P7393	2 S9 + 5 T111 + 5 T131
P7300	2 S7 + 6 T131	P7347	2 S8 + 8 T131	P7394	2 S9 + 10 T131
P7301	2 S7 + 3 T131 + 3 T141	P7348	2 S8 + 4 T131 + 4 T141	P7395	2 S9 + 5 T131 + 5 T141
P7302	2 S7 + 6 T141	P7349	2 S8 + 8 T141	P7396	2 S9 + 10 T141
P7303	2 S7 + 3 T141 + 3 T151	P7350	2 S8 + 4 T141 + 4 T151	P7397	2 S9 + 5 T141 + 5 T151
P7304	2 S7 + 6 T151	P7351	2 S8 + 6 T151	P7398	2 S9 + 10 T151
P7305	2 S7 + 3 T151 + 3 T161	P7352	2 S8 + 4 T151 + 4 T161	P7399	2 S9 + 5 T151 + 5 T161
P7306	2 S7 + 6 T161	P7353	2 S8 + 8 T161	P7400	2 S9 + 10 T161
P7307	3 S7 + 6 T101 + 3 T111	P7354	3 S8 + 8 T101 + 4 T111	P7401	3 S9 + 10 T101 + 5 T111
P7308	3 S7 + 3 T101 + 6 T111	P7355	3 S8 + 4 T101 + 8 T111	P7402	3 S9 + 5 T101 + 10 T111
P7309	3 S7 + 9 T111	P7356	3 S8 + 12 T111	P7403	3 S9 + 15 T111
P7310	3 S7 + 6 T111 + 3 T131	P7357	3 S8 + 8 T111 + 4 T131	P7404	3 S9 + 10 T111 + 5 T131
P7311	3 S7 + 3 T111 + 6 T131	P7358	3 S8 + 4 T111 + 8 T131	P7405	3 S9 + 5 T111 + 10 T131
P7312	3 S7 + 9 T131	P7359	3 S8 + 12 T131	P7406	3 S9 + 15 T131
P7313	3 S7 + 6 T131 + 3 T141	P7360	3 S8 + 8 T131 + 4 T141	P7407	3 S9 + 10 T131 + 5 T141
P7314	3 S7 + 3 T131 + 6 T141	P7361	3 S8 + 4 T131 + 8 T141	P7408	3 S9 + 5 T131 + 10 T141
P7315	3 S7 + 9 T141	P7362	3 S8 + 12 T141	P7409	3 S9 + 15 T141
P7316	3 S7 + 6 T141 + 3 T151	P7363	3 S8 + 8 T141 + 4 T151	P7410	3 S9 + 10 T141 + 5 T151
P7317	3 S7 + 3 T141 + 6 T151	P7364	3 S8 + 4 T141 + 8 T151	P7411	3 S9 + 5 T141 + 10 T151
P7318	3 S7 + 9 T151	P7365	3 S8 + 12 T151	P7412	3 S9 + 15 T151
P7319	3 S7 + 6 T151 + 3 T161	P7366	3 S8 + 8 T151 + 4 T161	P7413	3 S9 + 10 T151 + 5 T161
P7320	3 S7 + 3 T151 + 6 T161	P7367	3 S8 + 4 T151 + 8 T161	P7414	3 S9 + 5 T151 + 10 T161
P7321	3 S7 + 9 T161	P7368	3 S8 + 12 T161	P7415	3 S9 + 15 T161
P7322	4 S7 + 6 T111 + 6 T131	P7369	4 S8 + 8 T111 + 8 T131	P7416	4 S9 + 10 T111 + 10 T131
P7323	4 S7 + 3 T111 + 9 T131	P7370	4 S8 + 4 T111 + 12 T131	P7417	4 S9 + 5 T111 + 15 T131
P7324	4 S7 + 12 T131	P7371	4 S8 + 16 T131	P7418	4 S9 + 20 T131
P7325	4 S7 + 3 T141 + 9 T131	P7372	4 S8 + 4 T141 + 12 T131	P7419	4 S9 + 5 T141 + 15 T131
P7326	4 S7 + 6 T131 + 6 T141	P7373	4 S8 + 8 T131 + 8 T141	P7420	4 S9 + 10 T131 + 10 T141
P7327	4 S7 + 3 T131 + 9 T141	P7374	4 S8 + 4 T131 + 12 T141	P7421	4 S9 + 5 T131 + 15 T141
P7328	4 S7 + 12 T141	P7375	4 S8 + 16 T141	P7422	4 S9 + 20 T141



DESGLÓSE CONJUNTOS DE ESTANTERÍAS / BREAKDOWN OF SHELVING SETS / SETS DES ÉTAGÈRES / AUFLISTUNGSÜBERSICHT DER REGALSETS

FONDO 555 mm. Adaptable a GASTRONORM 1/1 / DEEPH 555 mm. Suitable for 1/1 GASTRONORM / PROFONDEUR 555 mm. Adaptable aux GASTRONORME 1/1 / Tiefe 555 mm. Passend für Gastronorm 1/1

REF. 3 niveles 3 levels 3 niveaux 3 Ebenen	DESGLÓSE BREAKDOWN COMPOSITION AUFLISTUNG
P7423	1 S1 + 3 T6
P7424	1 S1 + 3 T7
P7425	1 S1 + 3 T8
P7426	1 S1 + 3 T9
P7427	1 S1 + 3 T10
P7428	1 S1 + 3 T11
P7429	1 S1 + 3 T13
P7430	1 S1 + 3 T14
P7431	1 S1 + 3 T15
P7432	1 S1 + 3 T16
P7433	2 S1 + 6 T8
P7434	2 S1 + 3 T8 + 3 T9
P7435	2 S1 + 6 T9
P7436	2 S1 + 3 T9 + 3 T10
P7437	2 S1 + 6 T10
P7438	2 S1 + 3 T10 + 3 T11
P7439	2 S1 + 6 T11
P7440	2 S1 + 3 T11 + 3 T13
P7441	2 S1 + 6 T13
P7442	2 S1 + 3 T13 + 3 T14
P7443	2 S1 + 6 T14
P7444	2 S1 + 3 T14 + 3 T15
P7445	2 S1 + 6 T15
P7446	2 S1 + 3 T15 + 3 T16
P7447	2 S1 + 6 T16
P7448	3 S1 + 6 T10 + 3 T11
P7449	3 S1 + 3 T10 + 6 T11
P7450	3 S1 + 9 T11
P7451	3 S1 + 6 T11 + 3 T13
P7452	3 S1 + 3 T11 + 6 T13
P7453	3 S1 + 9 T13
P7454	3 S1 + 6 T13 + 3 T14
P7455	3 S1 + 3 T13 + 6 T14
P7456	3 S1 + 9 T14
P7457	3 S1 + 6 T14 + 3 T15
P7458	3 S1 + 3 T14 + 6 T15
P7459	3 S1 + 9 T15
P7460	3 S1 + 6 T15 + 3 T16
P7461	3 S1 + 3 T15 + 6 T16
P7462	3 S1 + 9 T16
P7463	4 S1 + 6 T11 + 6 T13
P7464	4 S1 + 3 T11 + 9 T13
P7465	4 S1 + 12 T13
P7466	4 S1 + 3 T14 + 9 T13
P7467	4 S1 + 6 T13 + 6 T14
P7468	4 S1 + 3 T13 + 9 T14
P7469	4 S1 + 12 T14

REF. 4 niveles 4 levels 4 niveaux 4 Ebenen	DESGLÓSE BREAKDOWN COMPOSITION AUFLISTUNG
P7470	1 S2 + 4 T6
P7471	1 S2 + 4 T7
P7472	1 S2 + 4 T8
P7473	1 S2 + 4 T9
P7474	1 S2 + 4 T10
P7475	1 S2 + 4 T11
P7476	1 S2 + 4 T13
P7477	1 S2 + 4 T14
P7478	1 S2 + 4 T15
P7479	1 S2 + 4 T16
P7480	2 S2 + 8 T8
P7481	2 S2 + 4 T8 + 4 T9
P7482	2 S2 + 8 T9
P7483	2 S2 + 4 T9 + 4 T10
P7484	2 S2 + 8 T10
P7485	2 S2 + 4 T10 + 4 T11
P7486	2 S2 + 8 T11
P7487	2 S2 + 4 T11 + 4 T13
P7488	2 S2 + 8 T13
P7489	2 S2 + 4 T13 + 4 T14
P7490	2 S2 + 8 T14
P7491	2 S2 + 4 T14 + 4 T15
P7492	2 S2 + 6 T15
P7493	2 S2 + 4 T15 + 4 T16
P7494	2 S2 + 8 T16
P7495	3 S2 + 8 T10 + 4 T11
P7496	3 S2 + 4 T10 + 8 T11
P7497	3 S2 + 12 T11
P7498	3 S2 + 8 T11 + 4 T13
P7499	3 S2 + 4 T11 + 8 T13
P7500	3 S2 + 12 T13
P7501	3 S2 + 8 T13 + 4 T14
P7502	3 S2 + 4 T13 + 8 T14
P7503	3 S2 + 12 T14
P7504	3 S2 + 8 T14 + 4 T15
P7505	3 S2 + 4 T14 + 8 T15
P7506	3 S2 + 12 T15
P7507	3 S2 + 8 T15 + 4 T16
P7508	3 S2 + 4 T15 + 8 T16
P7509	3 S2 + 12 T16
P7510	4 S2 + 8 T11 + 8 T13
P7511	4 S2 + 4 T11 + 12 T13
P7512	4 S2 + 16 T13
P7513	4 S2 + 4 T14 + 12 T13
P7514	4 S2 + 8 T13 + 8 T14
P7515	4 S2 + 4 T13 + 12 T14
P7516	4 S2 + 16 T14

REF. 5 niveles 5 levels 5 niveaux 5 Ebenen	DESGLÓSE BREAKDOWN COMPOSITION AUFLISTUNG
P7517	1 S3 + 5 T6
P7518	1 S3 + 5 T7
P7519	1 S3 + 5 T8
P7520	1 S3 + 5 T9
P7521	1 S3 + 5 T10
P7522	1 S3 + 5 T11
P7523	1 S3 + 5 T13
P7524	1 S3 + 5 T14
P7525	1 S3 + 5 T15
P7526	1 S3 + 5 T16
P7527	2 S3 + 10 T8
P7528	2 S3 + 5 T8 + 5 T9
P7529	2 S3 + 10 T9
P7530	2 S3 + 5 T9 + 5 T10
P7531	2 S3 + 10 T10
P7532	2 S3 + 5 T10 + 5 T11
P7533	2 S3 + 10 T11
P7534	2 S3 + 5 T11 + 5 T13
P7535	2 S3 + 10 T13
P7536	2 S3 + 5 T13 + 5 T14
P7537	2 S3 + 10 T14
P7538	2 S3 + 5 T14 + 5 T15
P7539	2 S3 + 10 T15
P7540	2 S3 + 5 T15 + 5 T16
P7541	2 S3 + 10 T16
P7542	3 S3 + 10 T10 + 5 T11
P7543	3 S3 + 5 T10 + 10 T11
P7544	3 S3 + 15 T11
P7545	3 S3 + 10 T11 + 5 T13
P7546	3 S3 + 5 T11 + 10 T13
P7547	3 S3 + 15 T13
P7548	3 S3 + 10 T13 + 5 T14
P7549	3 S3 + 5 T13 + 10 T14
P7550	3 S3 + 15 T14
P7551	3 S3 + 10 T14 + 5 T15
P7552	3 S3 + 5 T14 + 10 T15
P7553	3 S3 + 15 T15
P7554	3 S3 + 10 T15 + 5 T16
P7555	3 S3 + 5 T15 + 10 T16
P7556	3 S3 + 15 T16
P7557	4 S3 + 10 T11 + 10 T13
P7558	4 S3 + 5 T11 + 15 T13
P7559	4 S3 + 20 T13
P7560	4 S3 + 5 T14 + 15 T13
P7561	4 S3 + 10 T13 + 10 T14
P7562	4 S3 + 5 T13 + 15 T14
P7563	4 S3 + 20 T14

TRANSPORTE Y ALMACENAMIENTO /  
TRANSPORT & STORAGE /  
TRANSPORT ET STOCKAGE



**MAQUINARIA /  
MACHINERY / MACHINES / MASCHINEN**

<b>4.1</b>	<b>MANTECADORAS HELADO / ICE-CREAM MAKERS / TURBINES À GLACE / EISMASCHINEN</b>	<b>244</b>
<b>4.2</b>	<b>PROCESADOR ALIMENTOS / FOOD PROCESSORS / ROBOTS MULTIFONCTION / LEBENSMITTELMASCHINEN</b>	<b>248</b>
<b>4.3</b>	<b>BRAZOS TRITURADORES / IMMERSION BLENDERS / MIXEURS / STABMIXER</b>	<b>253</b>
<b>4.4</b>	<b>BATIDORAS / BLENDERS / MIXEURS/ MIXER</b>	<b>256</b>
<b>4.5</b>	<b>FREIDORAS / FRYERS / FRITEUSES/ FRITEUSEN</b>	<b>269</b>
<b>4.6</b>	<b>TOSTADORAS / TOASTERS / TOASTEURS/ TOASTER</b>	<b>271</b>
<b>4.7</b>	<b>GRILL DE CONTACTO Y PLANCHAS ELÉCTRICAS / CONTACT GRILL AND ELECTRIC GRIDDLES / GRILL DE CONTACT ET PLAQUES ÉLECTRIQUES / KONTAKTGRILL UND ELEKTRISCHE GRILLS</b>	<b>275</b>
<b>4.8</b>	<b>HORNOS Y MICRO-ONDAS / OVENS &amp; MICRO-WAVES / FOURS ET MICRO-ONDES / OFEN UND MIKROWELLEN</b>	<b>280</b>
<b>4.9</b>	<b>MAQUINARIA PARA CHOCOLATE / MACHINES FOR CHOCOLATE / MACHINES POUR LE CHOCOLAT / MASCHINEN FÜR SCHOKOLADE</b>	<b>282</b>
<b>4.10</b>	<b>MAQUINARIA MANTENEDORA DE TEMPERATURA / MACHINERY FOR KEEPING TEMPERATURE / APPAREILS DE MAINIEN EN TEMPÉRATURE / WARMHALTEMASCHINEN</b>	<b>285</b>

## GELATO 5K CREA SC

La mantecadora más compacta totalmente automática / The most compact completely automatic ice-cream maker /  
La turbine à glace la plus compacte totalement automatique / Die kompakteste vollautomatische Eismaschine

INOX - ST/STEEL  
EDELSTAHL

70 RPM

REF	VOLUMEN CONTENEDOR / CONTAINER VOLUME / VOLUME CONTENEUR / GROSSER BEHÄLTER L	W	V	Hz	Kg	U
P38.250.250	3,20	650	220-240	50	34	1

**1,25 Kg / 1,75 L**

Capacidad productiva por ciclo.  
Production capacity per cycle.  
Capacité productive par cycle.  
Verbesserte Produktionskapazität  
durch zyklischen Betrieb.

**12-15 min.**

Tiempo de preparación.  
Preparation time.  
Temps de préparation.  
Zubereitungszeit.

**5 Kg / 7,00 L**

Preparación máxima horaria.  
Maximum hourly preparation.  
Préparation maximum horaire.  
Maximierte stündliche Zubereitung.



Tapa con imán de seguridad.  
Easy clean, drain system.  
Couvercle à aimant de sécurité.  
Deckel mit Magnetverschluss.



Introducción fácil de ingredientes.  
Easy introduction of ingredients.  
Introduction facile d'ingrédients.  
Einfache Befüllung.



Sistema de desague, fácil limpieza.  
Easy clean, drain system.  
Système d'écoulement, nettoyage facile.  
Wasserablaufsystem, einfach zu reinigen.



Raspadoras ajustables extraíbles.  
Adjustable removable blades.  
Racloirs réglables amovibles.  
Verstellbare Abstreifer, abnehmbar.



Función manual.  
Manual function.  
Fonction manuelle.  
Manueller Betrieb.



4 programas de mantecación.  
4 ice-cream making programmes.  
4 programmes de malaxage.  
Vier Eiszubereitungsprogramme.



4 x 4 programas de conservación.  
4 x 4 conserving programmes.  
4 x 4 programmes de conservation.  
4 x 4 Konservationsprogramme.



### Mantecadora para producir, almacenar y distribuir helado.

1. Produce helado de forma automática y en poco tiempo.
2. Conserva el helado dentro de la máquina.
3. Distribuir el helado directamente.

Los 4 programas de mantecación.

- Gelato clásico.
  - Gelato semi-soft.
  - Granita (Granizado).
  - Abatidor rápido de temperatura.
- Control de la densidad automática. La pala se detiene automáticamente cuando el helado está listo.  
Desagüe de limpieza.  
Cuerpo y pala en acero inoxidable.  
Refrigeración por aire. Gas R404.

### Ice-cream maker to produce, store and dispense ice-cream.

1. Quickly and automatically produce ice-cream.
2. Conserve the ice-cream inside the machine.
3. Dispense ice-cream directly.

The 4 ice-cream making programmes.

- Classic ice-cream.
  - Semi-soft ice-cream.
  - Granita (crystallised ice).
  - Fast chiller.
- Automatic density control. The blade stops automatically when the ice cream is ready.  
Cleaning drain.  
Stainless steel body and blade.  
Air cooling. Gas R404.

### Turbine à glace pour produire, conserver et distribuer des glaces.

1. Produit des glaces de façon automatique et en peu de temps.
2. Conserve la glace dans la machine.
3. Distribue directement les glaces.

Les 4 programmes de malaxage.

- Gelato classique.
  - Gelato semi-soft.
  - Granita (Granité).
  - Refroidisseur rapide de température.
- Contrôle de densité automatique. La pale s'arrête automatiquement quand la glace est prête.  
Écoulement de nettoyage.  
Corps et pale en acier inoxydable.  
Réfrigération à l'air. Gaz R404.

### Eismaschine für die Herstellung, Aufbewahrung und Ausgabe von Eis

1. Automatische, schnelle Eisherstellung
2. Aufbewahrung des Eis in der Maschine
3. Ausgabe des Eis direkt aus der Maschine

Die vier Eiszubereitungsprogramme

- Klassisches Eis
  - Halbweiches (semi-soft) Eis
  - Granita (Slush - sizilianische Eisspeise).
  - Schnellfrierverfahren
- Automatische Kontrolle der Festigkeit. Die Rührklinge stoppt automatisch, wenn das Eis fertig ist.  
Ablaufreinigung.  
Körper und Klinge aus rostfreiem Stahl.  
Luftkühlung. Gas R404



## GELATO 5K SC

Mantecadora / Ice-cream maker / Turbine à glace / Eismaschine

INOX - ST/STEEL  
EDELSTAHL

70 RPM

REF	VOLUMEN CONTENEDOR / CONTAINER VOLUME / VOLUME CONTENEUR / GROSSER BEHÄLTER L	W	V	Hz	Kg	U
P38.240.250	3,20	600	220-240	50	34	1



1. Tapa con imán de seguridad.  
Lid with safety magnet.  
Couvercle à aimant de sécurité.  
Deckel mit Magnetverschluss.
2. Introducción fácil de ingredientes.  
Easy introduction of ingredients.  
Introduction facile d'ingrédients.  
Einfache Befüllung.
3. Sistema de desagüe, fácil limpieza.  
Easy clean, drain system.  
Système d'écoulement, nettoyage facile.  
Wasserablaufsystem, einfach zu reinigen.
4. Raspadoras ajustables extraíbles.  
Adjustable removable blades.  
Raclours réglables amovibles.  
Verstellbare Abstreifer, abnehmbar.

### Mantecadora para producir helados y sorbetes.

Control de la densidad automática. La pala se detiene automáticamente cuando el helado está listo. Desagüe de limpieza. Cuerpo, cubeta fija y pala (con insertos reemplazables) en acero inoxidable. Refrigeración por aire. Gas R404.

### Ice-cream maker to produce ice-cream and sorbets.

Automatic density control. The blade stops automatically when the ice-cream is ready. Drain for cleaning. Body, fixed pail and blade (with replaceable inserts) in stainless steel. Air cooled. Gas R404.

### Turbine à glace pour produire des glaces et sorbets.

Contrôle automatique de densité. La pale s'arrête automatiquement quand la glace est prête. Écoulement de nettoyage. Corps, cuve fixe et pale (à inserts interchangeables) en acier inoxydable. Réfrigération par air. Gaz R404.

### Eismaschine für die Herstellung von Eis und Sorbets

Automatische Kontrolle der Festigkeit. Die Klinge stoppt automatisch, wenn das Eis fertig ist. Reinigungsablauf Körper, Eisbehälter und Schaufeln (mit auswechselbaren Einsätzen) Edelstahl Luftkühlung. Gas R404.

**1,25 Kg / 1,75 L**

Capacidad productiva por ciclo.  
Production capacity per cycle.  
Capacité productive par cycle.  
Verbesserte Produktionskapazität durch zyklischen Betrieb.

**12-15 min.**

Tiempo de preparación.  
Preparation time.  
Temps de préparation.  
Zubereitungszeit.

Preparación máxima horaria.  
Maximum hourly preparation.  
Préparation maximum horaire.  
Maximierte stündliche Zubereitung.

**5 Kg / 7,00 L**



Ideal para los pequeños restaurantes.  
Ideal for small restaurants.  
Idéal pour les petits restaurants.  
Ideal für kleine Restaurants.



## GELATO 3K TOUCH

Mantecadoras / Ice-cream makers / Turbines à glace / Eismaschine

INOX - ST/STEEL  
EDELSTAHL

63 RPM

REF	VOLUMEN CONTENEDOR / CONTAINER VOLUME / VOLUME CONTENEUR / GROSSER BEHÄLTER L	W	V	Hz	Kg	U
P38.550.250	1,70	350	220-240	50	21	1



1. Tapa con imán de seguridad.  
Lid with safety magnet.  
Couvercle à aimant de sécurité.  
Deckel mit Magnetverschluss.
2. Introducción fácil de ingredientes.  
Easy introduction of ingredients.  
Introduction facile d'ingrédients.  
Einfache Befüllung.
3. Sistema de desagüe, fácil limpieza.  
Easy clean, drain system.  
Système d'écoulement, nettoyage facile.  
Wasserablaufsystem, einfach zu reinigen.
4. Raspadoras ajustables extraíbles.  
Adjustable removable blades.  
Raclours réglables amovibles.  
Verstellbare Abstreifer, abnehmbar.

### Mantecadora para producir helados y sorbetes.

Control de la densidad automática. La pala se detiene automáticamente cuando el helado está listo. Cuerpo, cubeta fija y pala (con insertos reemplazables) en acero inoxidable. Refrigeración por aire. Gas R404.

### Ice-cream maker to produce ice-cream and sorbets.

Automatic density control. The blade stops automatically when the ice-cream is ready. Body, fixed pail and blade (with replaceable inserts) in stainless steel. Air cooled. Gas R404.

### Turbine à glace pour produire des glaces et sorbets.

Contrôle automatique de densité. La pale s'arrête automatiquement quand la glace est prête. Corps, cuve fixe et pale (à inserts interchangeables) en acier inoxydable. Réfrigération par air. Gas R404.

### Eismaschine für die Herstellung von Eis und Sorbets

Automatische Kontrolle der Festigkeit. Die Klinge stoppt automatisch, wenn das Eis fertig ist. Körper, Eisbehälter und Schaufeln (mit auswechselbaren Einsätzen) Edelstahl Luftkühlung. Gas R404.

**0,8 Kg / 1,20 L**

Capacidad productiva por ciclo.  
Production capacity per cycle.  
Capacité productive par cycle.  
Verbesserte Produktionskapazität durch zyklischen Betrieb.

**12-15 min.**

Tiempo de preparación.  
Preparation time.  
Temps de préparation.  
Zubereitungszeit.

**3 Kg / 4,40 L**

Preparación máxima horaria.  
Maximum hourly preparation.  
Préparation maximum horaire.  
Maximierte stündliche Zubereitung.

# GELATO CHEF 5L AUTOMATIC

Mantecadoras / Ice-cream makers / Turbines à glace / Eismaschine

INOX - ST/STEEL  
EDELSTAHL

63 RPM

REF

VOLUMEN CONTENEDOR /  
CONTAINER VOLUME /  
VOLUME CONTENEUR /  
GROSSER BEHÄLTER

W

V

Hz

Kg

U

P36.790.250

2,50

280

220-240

50/60

20

1



### Mantecedora para uso profesional.

Control de la densidad automática. La pala se detiene automáticamente cuando el helado está listo. Cuerpo, cubeta fija y pala (con insertos reemplazables) en acero inoxidable. Timer mecánico de 60 minutos. Refrigeración por aire. Gas R404.

### Turbine à glace à usage professionnel.

Contrôle automatique de densité. La pale s'arrête automatiquement quand la glace est prête. Corps, cuve fixe et pale (à inserts interchangeables) en acier inoxydable. Minuteur mécanique de 60 minutes. Réfrigération par air. Gas R404.

### Ice-cream maker for professional use.

Automatic density control. The blade stops automatically when the ice-cream is ready. Body, fixed pail and blade (with replaceable inserts) in stainless steel. 60 minute mechanical timer. Air cooled. Gas R404.

### Eismaschine für die professionelle Nutzung.

Automatische Kontrolle der Festigkeit. Die Klinge stoppt automatisch, wenn das Eis fertig ist. Körper, Eisbehälter und Schaufeln (mit auswechselbaren Einsätzen) Edelstahl. Mechanische Zeitschaltuhr 60 Minuten. Luftkühlung. Gas R404.



1. Tapa con imán de seguridad.  
Lid with safety magnet.  
Couvercle à aimant de sécurité.  
Deckel mit Magnetverschluss.

2. Temporizador e interruptor refrigeración.  
Timer and cooling switch.  
Temporisateur et interrupteur réfrigération.  
Zeitschaltuhr für Gefrierprozess.

3. Cubeta extraíble (aluminio).  
Removable pail (aluminium).  
Cuve amovible (aluminium).  
Herausnehmbarer Behälter (Aluminium).

4. Raspadoras extraíbles.  
Removable blades.  
Racloirs amovibles.  
Herausnehmbare Abstreifer.

**1 Kg / 1,50 L**

Capacidad productiva por ciclo.  
Production capacity per cycle.  
Capacité productive par cycle.  
Verbesserte Produktionskapazität durch zyklischen Betrieb.

**20-30 min.**

Tiempo de preparación.  
Preparation time.  
Temps de préparation.  
Zubereitungszeit.

**2 Kg / 3,20 L**

Preparación máxima horaria.  
Maximum hourly preparation.  
Préparation maximum horaire.  
Maximierte stündliche Zubereitung.

## COMPARATIVA / COMPARISON / COMPARATIF / VERGLEICH

GELATO 5K  
CREA SC



GELATO 5K  
SC



GELATO 3K  
TOUCH



GELATO CHEF 5L  
AUTOMATIC



Alimentación / Power supply /  
Alimentation / Befüllung

220-240 V

50 Hz

650 W

220-240 V

50 Hz

600 W

220-240 V

50 Hz

350 W

220-240 V

50/60 Hz

280 W

Potencia / Power / Puissance / Leistung

Revoluciones por minuto / Revolutions per minute /  
Tours par minute / Umdrehungen pro Minute

70 RPM

70 RPM

63 RPM

63 RPM

Volumen contenedor / Container volume /  
Volume conteneur / Behältergröße

3,20 L

3,20 L

1,70 L

2,50 L

Desagüe / Drain / Vidange / Wasserablaufsystem

✓

✓

x

x

Cubeta extraíble / Removable pail /  
Cuve amovible / Herausnehmbarer Behälter

x

x

✓

✓

Capacidad productiva por ciclo /  
Production capacity per cycle /  
Capacité productive par cycle /  
Verbesserte Produktionskapazität durch zyklischen Betrieb

1,25 Kg / 1,75 L

1,25 Kg / 1,75 L

0,8 Kg / 1,20 L

1 Kg / 1,50 L

Tiempo de preparación / Preparation time /  
Temps de préparation / Zubereitungszeit

12-15 min.

12-15 min.

12-15 min.

20-30 min.

Preparación máxima horaria / Maximum hourly preparation /  
Préparation maximum horaire / Maximierte stündliche Zubereitung /

5 Kg / 7,00 L

5 Kg / 7,00 L

3 Kg / 4,40 L

2 Kg / 3,20 L

Programa de producción y conservación automática /  
Automatic production and preservation programme /  
Programme de production et conservation automatique /  
Programm für die automatische Produktion und Lagerung

✓

x

x

x

Dimensiones / Dimensions /  
Dimensions / Abmessungen

465 x 480 x 395 mm

465 x 480 x 395 mm

340 x 430 x 250 mm

450 x 320 x 315 mm

Peso neto / Net weight / Poids net / Nettogewicht

34 Kg

34 Kg

21 Kg

20 Kg

## FRIX'AIR

Emulsionador y procesador de alimentos /  
Food emulsifier and processor /  
Émulsionneur et processeur d'aliments /  
Emulgator und Küchenmaschine



INOX - ST/STEEL  
EDELSTAHL



2000 RPM

2 velocidades (1-2 minutos).  
2 speeds (1-2 minutes).  
2 vitesses (1-2 minutes).  
2 geschwindigkeiten (1-2 minuten).

REF	W	V	Hz	Kg	U
P94.500.250	600	220-240	50/60	21	1

**Procesador profesional que permite emulsionar, mezclar y triturar tanto alimentos congelados como frescos.**

Frix'Air funciona con recipientes monodosis de 180 ml con muchas ventajas:

- Máxima higiene.
- Congelación muy rápida.
- Disponibilidad inmediata de varias preparaciones.
- Garantiza la cadena de frío.
- Ocupan poco espacio.
- Apilables.

**Robot professionnel à émulsionner, mixer et mouliner des aliments surgelés ou frais.**

Frix'Air fonctionne à l'aide de récipients monodose de 180 ml offrant de nombreux avantages :

- Hygiène maximum.
- Congélation très rapide.
- Disponibilité immédiate de plusieurs préparations.
- Garantit la chaîne du froid.
- Prend peu de place.
- Empilables.

**Professional processor that allows emulsifying, mixing and blending of both frozen and fresh food.**

Frix'Air works with 180 ml single-dose containers with many advantages:

- Maximum hygiene.
- Very quick freezing.
- Immediate availability of various preparations.
- It guarantees the cold chain.
- They take up little space.
- Stackable.

**Profi-Processor, zum Emulgieren, Mischen und Zerkleinern von sowohl gefrorene undals auch frische Lebensmittel.**

Frix'Air arbeitet mit 180 ml Einzelbehältern mit vielen Vorteilen:

- Maximale Hygiene.
- Sehr schnelles Einfrieren.
- Sofortige Verfügbarkeit der verschiedenen Zubereitungen.
- Gewährleistet Kühlkette.
- Raumsparend.
- Stapelbar.

IDEA!

Ideal para preparar mousses, sorbetes, helados, salsas, sopas, cócteles y aperitivos.

Ideal for preparing mousses, sorbets, ice-creams, sauces, soups, cocktails and aperitifs.

Idéal pour préparer des mousses, sorbets, glaces, sauces, soupes, cocktails et apéritifs.

Ideal für die Herstellung Mousses, Sorbets, Eis, Soßen, Suppen, Cocktails und Aperitifs.

**Accesorios incluidos:**

- 2 Cuchillas de acero inoxidable.
- 1 Cuchilla de plástico.
- 2 Junta protectora.
- 2 Lleva recipientes en acero.
- 5 Recipientes de plástico con tapa.
- 1 Desmontador de cuchilla.

**Accessories included:**

- 2 St/Steel blades.
- 1 Plastic blade.
- 2 Protective seals.
- 2 Stainless steel containers.
- 5 Plastic containers with lid.
- 1 Blade remover.

**Accessoires inclus :**

- 2 lames en acier inoxydable.
- 1 lame en plastique.
- 2 joints protecteurs.
- 2 Muni de récipients en acier.
- 5 Récipients en plastique avec couvercle.
- 1 Outil démontage de lame.

**Zubehör im Lieferumfang enthalten:**

- 2 Edelstahlklingen.
- 1 Kunststoffmesser.
- 2 Schutzstecker
- 2 Stahlbehälter eingeschlossen.
- 5 Kunststoffbehälter mit Deckel.
- 1 Abnehmbare Klinge.



H.A.C.C.P.  
NO PROBLEM

**Colores / Colours / Couleurs / Farben**



**Cada pack contiene 10 u. de cada color. Each pack contains 10 units of each colour. Chaque pack contient 10 u. de chaque couleur. Jedes Set enthält zehn Stück jeder Farbe.**

Fácil identificación y separación de diferentes preparaciones.

Easy for identification and separation of different foodstuffs.

Identification et séparation faciles des différentes préparations.

Einfaches Erkennen und Unterscheiden unterschiedlicher Zubereitungen.

IDEA!

REBANADORAS Y CORTADORAS / SLICERS AND CUTTERS /  
TRANCHEURS ET COUPEURS / REIBEN UND SCHNEIDER

**P15090 / P15091** Cortadora eléctrica de fiambres / Electric slicing machine /  
Trancheur électrique / Elektrische Aufschnittmaschine

Cuerpo: aluminio pintado.  
Body: painted aluminium.  
Corps: aluminium peint.  
Körper: Aluminiumbeschichtet.

REF	V	Hz	W	Ø CUCHILLA BLADE LAME MESSER cm	ESPESOR CORTE SLICER THICKNESS ÉPAISSEUR DE COUPE SCHNITTBREITE mm	Dim cm	Kg	U
P15.089	220	50	120	22	0-11	48 x 40 x 37	13,3	1
P15.090	220	50	150	25	0-11	48 x 40 x 37	13,8	1
P15.091	220	50	250	30	0-14	59 x 38 x 43	24,0	1



Ref. P15.090  
Ø 25 cm  
Cuchilla / Blade / Lame / Messer



Ref. P15.091  
Ø 30 cm  
Cuchilla / Blade / Lame / Messer



**P15095** Cortador de verduras / Vegetable cutter / Coupe-légumes / Gemüseschneider

Cuerpo / Body / Corps / Körper :  
Aluminio / Aluminium

150 Kg/h



REF	V	Hz	W	Kg	U
P15.095	220	50	3/4 HP / 550 W	26,0	1

5 discos Incluidos / 5 disk included/ 5 lames Incluses / 5 Scheiben inklusive:  
Disco rallador de 3, 5 y 7 mm + Disco rebanador de 2 y 4 mm /  
Shredding disc 3, 4 & 7 mm + Slicing disc 2 & 4 mm /  
Disque à émincer de 3, 5 et 7 mm + Disque à trancher 2 et 4 mm /  
Scheibenschneider 3, 5 und 7 mm + Reibscheibe 2 und 4 mm

Disco rallador /  
Shredding disc /  
Disque à émincer /  
Reibscheibe



Disco rebanador /  
Slicing disc /  
Disque à trancher /  
Schneidscheibe



REF	CORTE / CUT COUPE / SCHNITT	U	REF	CORTE / CUT COUPE / SCHNITT	U
RE15095-1	3 mm	1	RE15095-4	2 mm	1
RE15095-2	5 mm	1	RE15095-5	4 mm	1
RE15095-3	7 mm	1			



DISCOS DE RECAMBIO / REPLACEMENT DISCS / DISQUES DE RÉCHANGE / WECHSELSCHEBEN

Disco patatas fritas /  
French fries disc /  
Disque Coupe frites /  
Pommesschneider



Disco para dados /  
Dicing disc /  
Disque dés /  
Würfelscheibe



Disco rebanador  
complementario /  
Complementary  
slicing disc /  
Disque laminoir  
complémentaire /  
Ergänzende  
Schneidscheibe



\*Para cortar patatas fritas o dados es imprescindible utilizar junto con el disco rebanador complementario.

\*In order to cut chipped or diced potatoes the use of the complementary slicing disc is essential.

\*Pour couper des frites ou des dés, il est indispensable d'utiliser, avec le disque, le laminoir complémentaire.

\*Zum Schneiden von Pommes Frites oder für Würfel, ist die Benutzung der Zusatzscheibe unabdinglich.

REF	CORTE / CUT COUPE / SCHNITT	U
RE15095-6	8 x 8	1
RE15095-7	10 x 10	1

REF	CORTE / CUT COUPE / SCHNITT	U
RE15095-8	8 x 8	1
RE15095-9	10 x 10	1

REF	CORTE / CUT COUPE / SCHNITT	U
RE15095-10	8 x 8	1
RE15095-11	10 x 10	1





# BATIDORAS / MIXERS / MÉLANGEURS / MIXERS

Engranajes y ejes de acero de fundición permiten alargar la vida del producto y proporcionan un funcionamiento más silencioso/  
Gears and shafts are made of heat-treated alloy steel for long life and quieter operation/  
Engrenages et arbres en acier allié traité à la chaleur pour une longue durée et un fonctionnement plus silencieux/  
Zahnräder und Wellen aus wärmebehandeltem legiertem Stahl gewährleisten eine lange Lebensdauer und einen leiseren Betrieb

Acción de batido elíptico /  
Planetary mixing action  
Mélangeur planétaire /  
Planetenrad-Misch-getriebe /

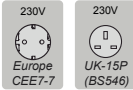

Paro automático por sobre calentamiento /  
Thermal overload protection automatically shuts off mixer to protect from damage  
Arrêt automatique par la surchauffe /  
Wärmeüberlastschutz schaltet den Mixer zur Schadens-verhütung automatisch aus

Temporizador digital 30 minutos, con paro automático con señal acústica /  
30 minute digital timer with automatic stop and audible shutoff signal /  
Minuterie numérique (30 minutes) à arrêt automatique et signal d'arrêt sonore /  
30-Minuten-Digitalzeituhr mit automatischem Stopp und akustischem Abschaltsignal

Velocidades de mezcla constantes independientemente del volumen /  
Consistent mixing speeds regardless of volume/  
Vitesses de mélange uniformes, quel que soit le volume /  
Gleichmäßige, von der Menge unabhängige Mischgeschwindigkeiten

Protección Seguridad /  
Safety guard /  
Protecteur de sécurité /  
Schutzblende

Construcción extra robusta /  
Heavy-duty construction /  
Construction robuste /  
Stark belastbare Ausführung

Incluye / Comes with / Livré avec / Standardausstattung:



Batidor varilla /  
Wire Wishk /  
Fouet à fil /  
Schlagbesen



Gancho para masa /  
Dough hook /  
Crochet de pâte /  
Knethaken



Espátula /  
Spatula /  
Spatule /  
Schaber



Bol acero inoxidable /  
S/Steel mixing bowl /  
Bol mélangeur en acier inoxydable /  
Edelstahl-Mischschüssel

## 4075502 Batidora sobre mesa / Countertop Mixers / Mélangeurs de comptoir / Arbeitsflächen-Mixer



1/3 HP / 250 W / 3 A



4075503

REF	Lts.	cm (W X D X H)	Velocidad / Speed / Vitesse / Geschwindigkeit	V	Enchufe / Plug / Prise / Stecker	U
4075502	6,6	33,5 x 45 x 51,5	5	220-230	Europe	1
4075503	6,6	33,5 x 45 x 51,5	5	220-230	UK	1
4075602	9,5	33,5 x 45 x 54	5	220-230	Europe	1
4075603	9,5	33,5 x 45 x 54	5	220-230	UK	1

REF	PARA / FOR / POUR / FÜR (LTS)	U
	Batidor varilla / Wire Wishk / Fouet à fil / Schlagbesen	
XMIX0705	6.6	1
40762	9.5	1
	Gancho para masa / Dough hook / Crochet de pâte / Knethaken	
XMIX0704	6.6	1
40763	9.5	1

REF	PARA / FOR / POUR / FÜR (LTS)	U
	Espátula / Spatula / Spatule / Schaber	
XMIX0703	6.6	1
40764	9.5	1
	Bol acer / Mixing bowl / Bol mélangeur / Mischschüssel	
XMIX0702	6.6	1
40761	9.5	1

Panel de control digital para simplificar el cambio de velocidades mientras la unidad está funcionando

Digital control panel to make easy speed shifts while unit is running.

Panneau de commande numérique pour faciliter les changements de vitesse pendant le fonctionnement de l'appareil

Digitalbedienfeld ermöglicht einfache Drehzahländerungen bei laufendem Gerät

**4075702** Batidora de pié / Floor-Bench mixers /  
Mélangeurs au sol-sur plan de travail / Boden-Tisch-Mixer



4075702

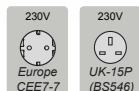

REF	Lts.	cm (WXDXH)	Velocidad / Speed / Vitesse / Geschwindigkeit	V	HP	W	A	Enchufe / Plug / Prise / Stecker	U
4075702	19	52 x 52 x 91	3	220-230	0,5	370	4	Europe	1
4075703	19	52 x 52 x 91	3	220-230	0,5	370	4	UK	1
4075802	28	64 x 62 x 122	3	220-230	1,0	750	8	Europe	1
4075803	28	64 x 62 x 122	3	220-230	1,0	750	8	UK	1
4075902	38	68 x 68 x 120	3	220-230	1,5	1120	11	Europe	1
4075903	38	68 x 68 x 120	3	220-230	1,5	1120	11	UK	1
4076002	57	70 x 76 x 142	3	220-230	2,0	1500	16	Europe	1
4076003	57	70 x 76 x 142	3	220-230	2,0	1500	16	UK	1

REF	PARA / FOR / POUR / FÜR (LTS)	U
	Batidor varilla / Wire Wishk / Fouet à fil / Schlagbesen	
40766	19	1
40770	28	1
40774	38	1
40778	57	1

REF	PARA / FOR / POUR / FÜR (LTS)	U
	Espátula / Spatula / Spatule / Schaber	
40768	19	1
40772	28	1
40776	38	1
40780	57	1

REF	PARA / FOR / POUR / FÜR (LTS)	U
	Gancho para masa / Dough hook / Crochet de pâte / Knethaken	
40767	19	1
40771	28	1
40775	38	1
40779	57	1

REF	PARA / FOR / POUR / FÜR (LTS)	U
	Bol acer / Mixing bowl / Bol mélangeur / Mischschüssel	
40765	19	1
40769	28	1
40773	38	1
40777	57	1







Ref. WFP116



Ref. WFP113



## WFP7E

Procesador de alimentos de 1.7 L /  
1.7-Liter Commercial Food Processor /  
Robot de cuisine professionnel de 1,7 L /  
1.7 Liter Küchenroboter

REF	W	U
WFP7E	3/4 HP / 560W	1

Motor de servicio pesado de 3/4 HP/560W.  
Bol transparente irrompible.  
Control de ENCENDIDO/APAGADO/PULSO fácil de usar.  
Cuchilla tipo "S" de acero inoxidable para picar, moler, mezclar y hacer purés (WFP7K1), disco rebanador 2 mm (WFP116), disco rallador fino (WFP113) y adaptador amovible (WFP7K2).  
Juego de empujadores con sistema de seguridad.  
230V CA, 50 Hz, 410 vatios, 1.8 A  
Homologado CE y RoHS.

Moteur haute performance de 3/4 HP/560W.  
Bol transparent incassable.  
Touche MARCHE/ARRÊT/PULSE facile à utiliser.  
Couteau en acier inoxydable pour hacher, broyer, mélanger et réduire en purée (WFP7K1), disque à trancher 2 mm (WFP116), disque à râper fin (WFP113) et adaptateur amovible (WFP7K2).  
Petit et gros poussoirs avec mécanisme de sécurité.  
230V C.A., 50 Hz, 410 watts, 1,8 A  
Homologué CE et RoHS.

Heavy-duty 3/4 HP high performance motor/560W.  
Clear-view unbreakable workbowl.  
Easy ON/OFF/PULSE control  
Stainless steel serrated S-blade to chop, grind, mix, and purée (WFP7K1), 2 mm slicing disc (WFP116), fine grating disc (WFP113), and detachable disc stem (WFP7K2).  
Small and large pushers with safety interlock sleeve.  
230 VAC, 50 Hz, 410 W, 1.8 amps  
CE, RoHS.

Hochleistungsmotor 3/4 HP/560W.  
Unzerbrechlicher transparenter Behälter. Einfache EIN/AUS/PULSE Bedienung.  
Messer Typ "S" aus rostfreiem Stahl zum Zerkleinern, Mahlen, Mixen und Pürieren (WFP7K1), Schneidscheibe 2 mm (WFP116), feine Reibscheibe (WFP113) und austauschbarer Adapter (WFP7K2).  
Schubsatz mit Sicherheitssystem.  
230 V CA, 50 Hz, 410 W, 1.8 A  
Zertifiziert mit CE, RoHS.

## WCG75E

Picadora - Moledora Pro Prep /  
Pro Prep Chopper Grinder /  
Hachoir - Broyeur Pro Prep /  
Fleischwolf - Mühle Pro Prep

REF	W	U
WCG75E	3/4 HP / 560W	1

Capacidad de 700 ml .  
Dos juegos de bol y cuchilla: uno para picar y otro para moler  
Potente motor de inducción de dos polos, de ¾ HP/560W.  
230V CA, 50 Hz, 0.9 A.  
Homologado RoHS.

Capacité de 700 ml.  
Deux bols/couteaux : un pour mouder et un pour émincer. Puissant moteur 2 pôles à induction de ¾ HP/560W.  
230V C.A., 50 Hz, 0,9 A.  
Homologué RoHS.

700 ml capacity.  
Two separate bowl and blade assemblies: one for grinding — one for chopping.  
Powerful high-speed 2-pole ¾ HP induction motor/560W.  
230 VAC, 50 Hz, 0.9 amps.  
RoHS.

700 ml Fassungsvermögen.  
2 Behälter und Messer; eines für den Fleischwolf eines für die Mühle.  
Starker Induktionsmotor mit zwei Polen, von ¾ HP/560W.  
230V CA, 50 Hz, 0.9 A  
Zertifiziert mit RoHS.





Lleve a cabo cualquier tarea de mezclado/licuado con los brazos trituradores portátiles Waring Commercial. Desde el versátil modelo QuickStik hasta el modelo de servicio pesado de 1 HP Big Stix, estos brazos trituradores son herramientas básicas para las cocinas más atareadas de hoy. Con varillas de 17.75 a 53.5 cm, permiten procesar desde 11.5 hasta 200 litros a la vez. Las cuchillas multifunción de acero inoxidable garantizan un licuado homogéneo, y el cómodo mango ofrece mayor control. ¡Licue, bata, mezcle y haga purés sin esfuerzo gracias a Waring!

Power through any mixture with the portable handheld Waring Commercial Immersion Blenders. From the versatile QuikStik to the heavy-duty 1 HP Big Stix, these are essential tools for today's busy kitchens. The shaft sizes range from 17.75 cm to 53.5 cm with capacities from 11.5 to 200 liters. The all-purpose stainless steel blades ensure smooth, consistent blending, and the comfort grips keep the user in control. Blend, whisk, mix, purée and whip with Waring!

Mixez en toute facilité grâce aux mixeurs Waring Commercial. Du plus pratique (le QuikStik) au plus puissant (le Big Stix de 1 HP), ce sont des outils essentiels pour les cuisines modernes. Leurs pieds de 17,75 à 53,5 cm permettent de mixer 11,5 à 200 L à la fois. Leurs lames en acier inoxydable garantissent des résultats homogènes. Leurs poignées ergonomiques offrent un maximum de confort. Mixez, fouettez, mélangez et réduisez en purée sans effort grâce à Waring !

Leistungsstarkes Mixen und Verflüssigen mit den Stabmixern Waring Commercial. Von dem vielseitigen Modell QuickStik bis hin zum robusten 1 HP Big Stick sind diese Stabmixer heutzutage ein wesentliches Werkzeug der vielbeschäftigten modernen Küchen. Mit Stablängen von 7.75 bis 53.5 cm kann man von 11.5 bis 200 Liter auf einmal bearbeiten. Die Multifunktionsmesser aus rostfreiem Stahl garantieren ein homogenes Zerkleinern und die bequemen Griffe bieten eine gute Kontrolle. Verflüssigen, Mixen und Pürieren Sie mühelos mit Waring!



WSB50E  
30,5 cm / 40 L

WSB55E  
35,5 cm / 60 L

WSB60E  
40,5 cm / 100 L



WSB65E  
45,5 cm / 140 L

WSB70E  
53,5 cm / 200 L



## WSB50E / WSB55E / WSB60E / WSB65E / WSB70E

Brazo triturador de servicio pesado Big Stix /  
Heavy-Duty Big Stix /  
Mixeur à usage intensif Big Stix /  
Einarmiger Hochleistungsstabmixer Big Stix

REF	VARILLA EXTRAÍBLE / REMOVABLE SHAFT / PIED AMOVIBLE / ABNEHMBARER STAB	CAPACIDAD / CAPACITY / CAPACITÉ / KAPAZITÄT	U
WSB50E (50 Hz)	30,5 cm	40 L	1
WSB55E (50 Hz)	35,5 cm	60 L	1
WSB60E (50 Hz)	40,5 cm	100 L	1
WSB65E (50 Hz)	45,5 cm	140 L	1
WSB70E (50 Hz)	53,5 cm	200 L	1

### Varilla / Shaft / Pied / Stab

REF	VARILLA EXTRAÍBLE / REMOVABLE SHAFT / PIED AMOVIBLE / ABNEHMBARER STAB	U
WSB50ST	30,5 cm	1
WSB55ST	35,5 cm	1
WSB60ST	40,5 cm	1
WSB65ST	45,5 cm	1
WSB70ST	53,5 cm	1

Bloque motor universal adaptable a todos los brazos y batidores.  
Motor de servicio pesado de 1 HP (potencia de entrada máxima)  
Velocidad variable.  
18 000 RPM a velocidad alta (1600 RPM con los batidores).  
Función de encendido continuo.  
Acoplamientos (bloque-motor y varilla) reemplazables por el usuario.  
Cómodo mango cubierto de caucho y empuñadura auxiliar, para mayor control y seguridad.  
Varilla de acero inoxidable sellada, removible y apta para lavavajillas.

Universal power pack fits all shafts and whisk attachments.  
1 peak input HP heavy-duty motor.  
Variable speed operation  
18,000 RPM on high (1,600 for whipping paddles).  
Continuous ON feature.  
User-replaceable couplings on power pack and shaft.  
Rubberized comfort grip and second handle for safe and controlled operation.  
Completely sealed stainless steel shaft is easily removable and dishwasher safe.

Bloc-moteur universel adaptable à tous les pieds et fouets.  
Moteur haute performance de 1 HP (puissance d'entrée maximale).  
Vitesse variable.  
18.000 tr/mn à haute vitesse (1 600 tr/mn avec les fouets).  
Marche continue.  
Accouplements (bloc-moteur et pied) faciles à changer.  
Poignée caoutchoutée et poignée auxiliaire, pour davantage de confort et de sécurité.  
Pied hermétique en acier inoxydable, amovible et compatible lave-vaisselle.

Universeller Motorblock geeignet für alle Stablängen und Halter.  
Hochleistungsmotor von 1 HP (max. Eingangsleistung). Variable Geschwindigkeit. Max. 18.000 U/min (1.600 U/min. Rührbesen).  
Funktion Dauerbetrieb.  
Durch Kopplung (Motorblock - Stab) vom Benutzer austauschbar.  
Bequemer Griff mit Kautschukbeschichtung und Hilfsgriff bieten eine höhere Kontrolle und Sicherheit. Stab aus versiegeltem rostfreiem Stahl, austauschbar und Spülmaschinen geeignet.



## WSBPPCE

Bloque motor / Bloc-moteur /  
Power Pack / Motorblock

REF	U
WSBPPCE	1



INOX - ST/STEEL  
EDELSTAHL

## WSB2W

Accesorio batidor /  
Whisk Attachment /  
Fouets /  
Rührbesen Zubehör

REF	L cm	U
WSB2W	25,5	1

Caja de engranaje de fundición, para mejor desempeño.

Engrenage en acier moulé, pour des performances optimales.

Die-cast gears for optimal performance.

Gegossenes Getriebegehäuse für eine bessere Performenz.



## WSB33XE

Brazo triturador de servicio ligero Quik Stik /  
Light-Duty Quik Stik /  
Mixeur Quick Stik à usage léger /  
Stabmixer leichter Gebrauch Quik Stik

REF	U
WSB33XE	1

Motor de alta eficacia, con dos velocidades  
Varilla fija de 17.75 cm  
Capacidad de 11.5 litros  
230V, 50 Hz, 0.4 A, 175W  
Homologado CE y RoHS

Moteur hautement efficace à deux vitesses  
Pied fixe de 17,75 cm  
Capacité de 11,5 litres  
230V, 50 Hz, 0,4A, 175W  
Homologué CE et RoHS

2-speed high-efficiency motor  
17.75 cm fixed shaft  
11.5-liter capacity  
230 volts, 50 Hz, 0.4 amps, 175W  
CE, RoHS

Motor mit hoher Leistung und zwei Geschwindigkeiten und festem Stab von 17.75 cm Länge. Bearbeitungsvermögen 11.5 Liter. 230V, 50 Hz, 0.4 A, 175W  
Zertifiziert mit CE und RoHS



## WSB40E

Brazo triturador de servicio mediano /  
Quik Stik Plus / Medium-Duty Quik Stik Plus /  
Mixeur Quick Stik Plus à usage moyen /  
Stabmixer mittlerer Gebrauch Quik Stik Plus

REF	U
WSB40E	1

Motor de servicio pesado de ½ HP, con 2 velocidades/370W.  
Varilla fija de 25.5 cm.  
Capacidad de 23 litros  
230V, 50 Hz, 1.5 A.  
Homologado CE y RoHS.

Puissant moteur de ½ HP, à deux vitesses/370W.  
Pied fixe de 25,5 cm.  
Capacité de 23 litres.  
230V, 50 Hz, 1,5A.  
Homologué CE et RoHS.

½ HP, 2-speed heavy-duty motor/370W.  
25.5 cm fixed shaft.  
23-liter capacity .  
230 volts, 50 Hz, 1.5 amps. CE, RoHS

Ochleistungsmotor von ½ HP, mit 2 Geschwindigkeiten /370W. Fester Stab von 25.5 cm. Bearbeitungsvermögen 23 Liter. 230V, 50 Hz, 1,5 A, Zertifiziert mit CE und RoHS





Desde 1937, Waring Commercial domina el mercado de las batidoras de vaso profesionales, gracias a sus potentes batidoras de alto rendimiento. Equipadas con motores de servicio pesado de hasta 2800W, estas rápidas e inigualables herramientas son capaces de licuar cualquier combinación de alimentos, rápidamente y sin esfuerzo. Sus vasos de policarbonato, cristal o acero inoxidable con capacidad de 1 a 4 litros han sido diseñados para satisfacer las exigencias de cualquier cocina comercial. ¡Estas potentes batidoras son herramientas básicas, con habilidades excepcionales!

Since 1937, the Waring Commercial Blender has led the industry in power and performance. With unequalled speed and efficiency, the heavy-duty motors use up to 2800W to power through any combination of ingredients in no time. Capacities range from 1 to 4 liters with polycarbonate, glass, and stainless containers designed to meet the demands of every commercial kitchen. It's the basic tool with exceptional abilities!

Depuis 1937, les puissants bols mixeurs à usage intensif Waring Commercial dominent le marché des bols mixeurs professionnels. Équipés de moteurs haute performance jusqu'à 2800W, ces puissants appareils sont capables de mixer n'importe quels ingrédients, rapidement et sans effort. Leurs bols en polycarbonate, verre ou acier inoxydable de 1 à 4 L ont été conçus pour répondre aux exigences de toutes les cuisines commerciales.

Des outils de base...un talent hors du commun !

Seit 1937 dominiert Waring Commercial den Markt der professionellen Standmixer und Behälter, dank seiner leistungsstarken Mixer. Ausgestattet mit starken und effizienten Motoren bis zu 2800W sind sie schnelle und unvergleichbare Werkzeuge, die jedwede Lebensmittelkombination verflüssigen; schnell und einfach. Ihre Behälter aus Polycarbonat, Glas oder Edelstahl mit einem Fassungsvermögen von 1 bis 4 Liter sind entwickelt worden um die Ansprüche der professionellen Küche zufriedenzustellen. Diese leistungsstarken Standixer sind Basiswerkzeuge mit aussergewöhnlichen Qualitäten!



BLADE



21700 RPM - 3,6 A



BB300E

Batidora de vaso comercial Blade Series /  
Blade Series Commercial Blender /  
Mixeur à jarre commerciale Blade Series /  
Gewerblicher Standmixer Blade Series

REF	V	W	Hz	U
BB300E	220-240	1 HP / 820 W	50/60	1

Jarra copoliéster.  
Controles mecánicos: Alto, Bajo,  
Apagado y Pulso.

Bol en copolyester.  
Interrupteurs à bascule: Haut, Bas, Arrêt  
et Pulse.

Copolyester container.  
High, Low, Off and Pulse toggle switches.

Behälter aus copolyester.  
Mechanische Kontrolle: High, Low, Off  
und Puls.

CAC132

Jarra / Container /  
Bol / Karaffen

REF	Lts	U
CAC132	1,40	1

Apilable / Stackable /  
Empilable / Stapelbar

BLADE



21700 RPM - 3,6 A



BB340E

Batidora de vaso comercial Blade Series /  
Blade Series Commercial Blender /  
Mixeur à jarre commerciale Blade Series /  
Gewerblicher Standmixer Blade Series

REF	V	W	Hz	U
BB340E	220-240	1HP / 820W	50/60	1

Jarra copoliéster.  
Controles electrónicos: Alto, Bajo,  
Apagado y Pulso.  
Con temporizador de cuenta regresiva  
de 99 segundos.

Copolyester.  
Contrôle électronique: Haut, Bas, Arrêt  
et Pulse.  
Avec minuteur de 99 secondes

Copolyester container.  
High, Low, Off and Pulse electronic  
controls.  
With 99-second countdown timer.

Copolyester.  
Elektronische Kontrolle: High, Low, Off  
und Puls.  
Mit 99 Sekunden Countdown Timer.

24500 RPM - 3,3 A



Ref. HGB25E

HGB25E

Batidora de vaso de 2 litros /  
2-Liter food blender /  
Blender de 2 litres /  
2 Liter Standmixer

REF	Lts	V	W	Hz	U
HGB25E	2	220-240	1 HP / 820 W	50/60	1

2 velocidades.  
Jarra y cuchilla de acero inoxidable.  
Acoplamiento de eje de caucho reforzado  
con metal, fácil de reemplazar.

2 vitesses.  
Bol et couteau en acier inoxydable.  
Accouplement renforcé en métal, facile à  
remplacer.

2 speeds.  
Stainless steel container and blade.  
Easily replaceable metal-reinforced rubber  
drive coupling

2 geschwindigkeiten.  
Behälter und Messer aus rostfreiem Stahl.  
Kupplungsachse aus Kautschuk mit  
metallischer Verstärkung, einfach  
austauschbar.

## BATIDORAS PARA ALIMENTOS &amp; CÓCTELES / FOOD &amp; BAR BLENDERS / BOLS MIXEURS / ESSENS- U. GETRÄNKEMIXER



# TORQ 2.0

Tapa para alimentos/  
líquidos calientes de vinilo  
con tapón extraíble.

Vinyl lid for hot food/  
beverage blending and  
removable center cap  
that locks into place or  
can be removed to feed  
ingredients while blending.

Couvercle en vinyle pour  
aliments/liquides chauds  
avec bouchon doseur  
amovible.

Deckel für heiße  
Lebensmittel/  
Flüssigkeiten aus Vinyl  
mit abnehmbarem  
Verschlusskopf.

Jarra apilable transparente  
de 1.4 L resistente, de  
servicio pesado y de calidad  
profesional. Diseño  
único, para máxima eficacia y  
rendimiento.

1.4L clear-view stackable jar  
- commercial  
grade, heavy-duty and  
breakresistant.  
Uniquely shaped for maximum  
efficiency and performance.

Bol transparent empilable de  
1,4 L résistant,  
à usage intensif et de qualité  
professionnelle.  
Spécialement conçu pour  
maximiser l'efficacité et le  
rendement.

1,4 l stapelbarer transparenter  
Behälter, resistent gegen  
häufigen Gebrauch und mit  
professioneller Qualität.  
Einzigartiges Design für  
höchste Effizienz und Leistung.

Resistente cuchilla de acero  
inoxidable con robustas piezas  
de acero, hechas para durar  
pero reemplazables por el  
usuario. Su forma "agresiva"  
ha sido especialmente  
diseñada para este vaso y  
es capaz de picar hielo al  
instante.

Heavy-duty stainless steel  
blade with solid steel blending  
assembly - built to last but  
completely user-replaceable.  
This aggressive blade design is  
configured specifically for this  
jar and is engineered to crush  
ice instantly.

Couteau en acier inoxydable  
avec pièces en acier massif  
construits pour durer mais  
remplaçables par l'utilisateur.  
Couteau "agressif"  
spécialement conçu pour le bol  
et capable de broyer la glace  
instantanément.

Resistente Messer aus  
rostfreiem Stahl mit robusten  
Stahlteilen, gemacht für  
Langlebigkeit aber auch durch  
den Benutzer austauschbar.  
Die "aggressive" Form ist  
speziell für den Behälter  
designt und ist in der Lage Eis  
sehr schnell zu crashen.

Controles HI/LO/STOP/  
PULSE con temporizador  
de cuenta progresiva de  
60 segundos (modelos  
sin temporizador también  
disponibles) - Las  
batidoras de vaso Margarita  
Madness® Elite vienen  
equipadas con tres tipos de  
controles: mecánicos,  
electrónicos y electrónicos  
con temporizador.

HI/LO/STOP/PULSE controls  
with 60-second countdown  
timer (non-timer versions  
available) - the Margarita  
Madness Elite Series  
Blenders feature three  
control styles - a simple  
toggle switch control,  
electronic keypad and  
electronic keypad with  
60-second countdown timer.

Commandes HAUT/BAS/  
ARRÊT et PULSE avec  
minuteur de 60 secondes  
(modèles sans minuteur  
également disponibles). Les  
bols mixeurs de la série  
Margarita Madness Elite sont  
disponibles en trois styles :  
commandes mécaniques,  
commandes électroniques  
ou commandes  
électroniques avec minuteur  
de 60 secondes.

HI/LO/STOP/PULSE  
Kontrolle  
mit 60 Sekunden Countdown.  
(Modelle ohne Timerfunktion  
auch erhältlich) - Die Mixer  
Margarita Madness® Elite  
sind ausgestattet mit 3  
verschiedenen Kontrollen:  
Mechanisch, Elektronisch  
oder Elektronisch mit  
Timerfunktion.

Base resistente y compacta  
con potente motor de 2  
HP/1490 vatios y cojinete  
amortiguador removible para  
facilitar la limpieza.

Heavy-duty base with  
powerful 2 HP, 1490W motor  
- this amazing combination  
makes for big power yet  
small foot print and includes  
a removable jar pad for easy  
cleanup.

Boîtier résistant et compact  
avec puissant moteur  
de 2 HP/1490W et coussin  
amortisseur amovible  
pour faciliter le nettoyage.

Resistente und kompakte  
Basis mit einem  
leistungsstarken  
Motor von 2 HP, 1490W  
und mit abnehmbarem  
Stossdämpfungseinheit zur  
einfachen Reinigung



# TORQ 2.0

**2 HP / 1490 W  
24500 RPM - 6,1 A**

**1,4 Lts**

Jarra.  
Container.  
Bol.  
Karaffen.



## TBB145E

Batidora de vaso Torq / Torq blender / Blender Torq / Mixer der Torq

REF	V	W	Hz	U
TBB145E	220-240	2 HP / 1400 W	50/60	1

Controles mecánicos clásicos.  
Classic toggle switch.  
Interrupteur à bascule.  
Klassischer.



## TBB160E

Batidora de vaso Torq / Torq blender / Blender Torq / Mixer der Torq

REF	V	W	Hz	U
TBB160E	220-240	2 HP / 1400 W	50/60	1

Controles electrónicos con temporizador de cuenta regresiva de 60 segundos.  
Electronic keypad with 60-second countdown timer.  
Contrôle électronique avec minuteur de 60 secondes.  
Elektronische Kontrolle mit 60 Sekunden Countdown Timer.



## TBB175E

Batidora de vaso Torq / Torq blender / Blender Torq / Mixer der Torq

REF	V	W	Hz	U
TBB175E	220-240	2 HP / 1400 W	50/60	1

Control de velocidad variable.  
Variable speed control.  
Contrôle de vitesse variable.  
Variable Geschwindigkeititskontrolle.







Las batidoras de vaso profesionales Waring Commercial son herramientas esenciales para cualquier bar o restaurante. Esta línea clásica siempre logra resultados profesionales, gracias a características profesionales: resistentes jarras de alta capacidad de acero inoxidable, copoliéster sin bisfenol-A o cristal; potentes motores de hasta 1120W y cuchillas de acero inoxidable que siempre logran resultados rápidos y homogéneos. ¡Pique hielo y prepare bebidas en tan sólo segundos con las potentes licuadoras profesionales Waring Commercial!

The staple in any bar or restaurant, the Waring Commercial Blender consistently delivers a professional blend. This classic product line offers a variety of sizes, styles and capacities in durable stainless, BPA-free copolyester, or glass containers. Powerful, professional motors with up to 1120W HP drive stainless steel cutting blades for quick, consistent results. Crush ice in seconds and make drinks instantly with the power of Waring Commercial!

Les blenders Waring Commercial sont les outils de base par excellence pour tout type de bar ou restaurant. Disponibles en plusieurs tailles et styles (acier inoxydable, copolyester sans BPA, verre), ces outils classiques sont équipés de puissants moteurs professionnels jusqu'à 1120W et de couteaux en acier inoxydable, pour des résultats rapides et homogènes. Broyez de la glace et préparez des boissons en quelques secondes grâce aux puissants bols mixeurs Waring Commercial!

Die professionellen Standmixer von Waring Commercial sind essentielle Werkzeuge für jede Bar oder Restaurant. Die klassische Produktlinie bietet immer professionelle Ergebnisse, dank seiner professionellen Eigenschaften:

Resistente Behälter von grossem Fassungsvermögen aus rostfreiem Stahl, Glas oder Copolyester ohne Bisfenol-A (BPA); leistungsstarken Motoren von bis zu 1120W und messer aus rostfreiem Stahl, die immer für ein schnelles und homogenes Ergebnis sorgen. Zerkleinern Sie Eis und bereiten Sie Getränke in Sekundenschnelle mit den leistungsstarken Mixern von Waring Commercial!







21000 RPM - 2,2 A



## BB255E

Batidoras de vaso para cócteles básicas / Basic Bar Blenders /  
Blenders de bar / Basis Cocktail Mixer

REF	Lts	V	W	Hz	U
BB255E	1,30	220-240	3/4 HP / 500 W	50/60	1

2 velocidades.  
Resistente cuchilla de acero inoxidable de dos piezas.

Acoplamiento de goma reforzado con metal y reemplazable por el usuario.  
BB255E: Jarra copoliéster.  
BB155SE: Jarra de acero inoxidable.

2 speeds.  
Rugged, two-piece stainless steel cutting blade.  
User-replaceable, metal-reinforced rubber drive coupling.  
BB255E: Copolyester container.  
BB155SE: St/Steel container.

2 vitesses.  
Couteau 2 pièces robuste et en acier inoxydable.

BB255E: Bol en copolyester.  
BB155SE: Bol en acier inoxydable.

2 geschwindigkeiten.  
Zweiteilige robuste Edelstahl Klingen  
BB255E: Behälter aus copolyester.  
BB155SE: Behälter aus rostfreiem Stahl.

28000 RPM - 1,4 A



## CB15VE

Batidora de vaso 4 litros / 4-Liter food blender /  
Bol mixeur 4 litres / Standmixer mit 4 Liter Behälter

REF	Lts	V	W	Hz	U
CB15VE	4,0	230	3,75 HP / 2800W	50	1
CAC72	Jarra / Container / Bol / Behälter				1
CBL10					1

Jarra de acero inoxidable con asas y tapa de caucho.  
Cojinete amortiguador de una pieza, apto para lavavajillas.  
Controles de velocidad variable (no se muestra).

Stainless steel container with two handles and rubberized lid.  
Dishwasher-safe one-piece jar pad for easy cleaning.  
Variable speed controls (not shown).

Bol en acier inoxydable avec anses et couvercle caoutchouté.  
Coussin amortisseur d'une pièce, compatible lave-vaisselle.  
Contrôle de vitesse variable (non représenté).

Behälter und Griffe aus rostfreiem Stahl und Deckel aus Kautschuk.  
Stossdämpfereinheit aus einem Stück für Spülmaschinen geeignet.  
Variable Geschwindigkeitskontrolle (nicht gezeigt).

### CBL10



Tapa para líquidos calientes.  
Hot blending lid.  
Couvercle pour liquides chauds.  
Deckel für heiße Flüssigkeiten.



Con potencia máxima de hasta 3½ HP/2600W, las batidoras de vaso de alta potencia de la serie Xtreme de Waring Commercial dan una potente ventaja a cualquier negocio. Logran impecables resultados y ofrecen mayor versatilidad, gracias a características únicas como temporizador integrado y velocidad variable hasta 30 000+ RPM. Con duraderas jarras de acero inoxidable o copoliéster sin bisfenol A (BPA) y controles electrónicos o mecánicos fáciles de usar, son perfectas para todas sus tareas de preparación de bebidas y alimentos.

Waring Commercial heavy-duty 3½ peak HP/2600W Blenders give every commercial environment a high-powered advantage. With 30,000+ RPM and models with built-in timers and variable speeds, these high-performance blenders produce flawless results every time. The durable BPA-free copolyester or stainless steel containers with simple touchpads or toggles are perfect for anything from food prep to smoothies!

Les blenders de la gamme Xtreme, équipés de moteurs de 3½ HP/2600W, sont un atout de taille pour les professionnels de la restauration. Dotés de caractéristiques uniques (moteurs à vitesse variable de 30.000+ tr/mn, minuteur sur certains modèles), ces puissants appareils permettent de toujours obtenir des résultats optimaux. Équipés de bols en copolyester sans PBA ou en acier inoxydable et de contrôles électroniques ou interrupteurs à bascule, ils sont parfaits pour toutes les tâches de préparation d'aliments et de boissons.

Mit der Höchstleistung von bis zu 3½ HP/2600W, geben die Xtreme Hochleistungsstandmixer von Waring Commercial jedem Geschäft einen aussagekräftigen Vorteil.

Sie bieten unschlagbare Ergebnisse und eine hohe Vielseitigkeit, dank seiner einzigartigen Eigenschaften mit einem integrierten Timer und einer regulierbaren Geschwindigkeit von bis zu 300.000+ U/min. Mit langlebigen Behältern aus Edelstahl oder Copolyester ohne Bisphenol A (BPA) und einer elektronischen oder mechanischen Kontrolle für die einfache Handhabung, eignen sie sich perfekt für alle Aufgaben der Getränke und Lebensmittelzubereitung.

ROBUSTO MOTOR DE 3½ HP/2600W  
VELOCIDAD SUPERIOR A 30 000 RPM COJINETE  
AMORTIGUADOR DE UNA PIEZA,  
EXTRAIBLE Y APTO PARA LAVAVAJILLAS

HEAVY-DUTY 3.5 PEAK/2600W HP MOTOR  
BLADE SPEED OF OVER 30,000 RPM  
ONE-PIECE DISHWASHER-SAFE  
REMOVABLE JAR PAD

MOTEUR HAUTE PERFORMANCE DE 3½  
HP/2600W VITESSE SUPÉRIEURE À 30 000 TR/  
MN COUSSIN AMORTISSEUR D'UNE PIÈCE,  
AMOVIBLE ET COMPATIBLE LAVE-VAISSELLE

ROBUSTER MOTOR 3½ HP/2600W  
HÖCHSTGESCHWINDIGKEIT ÜBER 30 000 U/MIN  
STOSSDÄMPEREINHEIT AUS EINEM STÜCK  
AUSTAUSCHBAR UND SPÜLMASCHINEN  
GEEIGNET





BATIDORAS PARA ALIMENTOS & CÓCTELES / FOOD & BAR BLENDERS /  
BOLS MIXEURS / ESSENS- U. GETRÄNKEMIXER

Cojinete amortiguado de una sola pieza extraíble y apto para lavavajillas.  
One-piece dishwasher-safe removable jar pad.  
Cousin amortisseur d'une pièce, amovible et compatible lave-vaisselle.  
Stossdämpereinheit aus einem Stück.



30000 RPM



**MX1000TXEE / MX1000XTPEE**

REF	Lts	W	U
MX1000TXEE	2,00	3,5 HP / 2600 W	1
MX1000XTPEE	1,40	3,5 HP / 2600 W	1

Sencillos controles mecánicos:  
ALTO/BAJO/APAGADO y PULSO.

Interrupteurs à bascule HAUT/  
BAS/ARRÊT et PULSE.

Simple HIGH, LOW, OFF and  
PULSE paddle switches.

Einfache mechanische Kontrolle:  
HIGH, LOW, OFF und PULSE.



45000 RPM



**MX1100TXSEE / MX1100XTPSEE**

REF	Lts	W	U
MX1100TXSEE	2,00	3,5 HP / 2600 W	1
MX1100XTPSEE	1,40	3,5 HP / 2600 W	1

Controles electrónicos fáciles de  
limpiar con funciones de  
ENCENDIDO/APAGADO, ALTO,  
BAJO, PAUSA y PULSO  
Temporizador electrónico de  
cuenta regresiva de 30 segundos  
Con recinto insonorización

Contrôle électronique facile à  
nettoyer avec boutons  
MARCHE/ARRÊT, HAUT, BAS,  
PAUSE et PULSE  
Minuteur électronique de 30  
secondes  
Avec système d'insonorisation

Easy-to-clean electronic  
membrane keypad with simple  
ON/OFF, HIGH, LOW, STOP and  
PULSE controls  
30-second electronic countdown  
timer  
With sound enclosure

Elektronische Kontrolle einfach zu  
reinigen mit Funktionen ON/OFF,  
HIGH, LOW, STOP und PULSE.  
Elektronischer Timer mit 30  
Sekunden Countdown Funktion.  
Gehäuse mit Geräuschisolierung



45000 RPM



**MX1500TXSEE / MX1500XTPSEE**

REF	Lts	W	U
MX1500TXSEE	2,00	3,5 HP / 2600 W	1
MX1500XTPSEE	1,40	3,5 HP / 2600 W	1

4 botones programables para  
preparar bebidas  
Pantalla LCD con retroiluminación  
azul, para mayor comodidad  
Contador de bebidas con total y  
total diario  
Velocidad variable  
Función de pulso con control de  
velocidad programable  
Con recinto de insonorización.

Quatre boutons programmables pour  
la préparation des boissons  
Écran numérique avec rétro-  
éclairage  
Compteur qui affiche le total de  
préparations du jour et le grand total  
Vitesse variable  
Double fonction PULSE avec vitesse  
programmable  
Avec système d'insonorisation.

4 reprogrammable beverage stations  
LCD display with blue backlight for  
easy viewing and program selection  
Daily and total drink counter display  
Adjustable speed controls  
Dual PULSE feature with  
reprogrammable speed control.  
With sound enclosure.

Station mit 4 programmierbaren  
Knöpfen zur Getränkezubereitung.  
LCD Display mit blauer Beleuchtung,  
für die einfache Handhabung.  
Gesamt- und Tageseinheitenzähler.  
Variable Geschwindigkeit  
PULSE Funktion mit  
programmierbarer Geschwindigkeit.  
Gehäuse mit Geräuschisolierung.

BATIDORAS PARA ALIMENTOS & CÓCTELES / FOOD & BAR BLENDERS / BOLS MIXEURS / ESSENS- U. GETRÄNKEMIXER



20000 RPM

### MX1200XTXEE

Batidora de vaso de alta potencia con velocidad variable / Hi-Power Variable Speed Blender / Blender haute puissance à vitesse variable / Hochleistungsstandmixer mit variabler Geschwindigkeit

REF	Lts	W	U
MX1200XTXEE	2,00	3,5 HP / 2600 W	1

Cojinete amortiguador de una pieza, extraíble y apto para lavavajillas. Garantía limitada de tres años (motor) y dos años (materiales y mano de obra). Jarras y recintos de insonorización disponibles.

Coussin amortisseur d'une pièce, amovible et compatible lave-vaisselle. Garantie limitée de 3 ans (moteur) et deux ans (pièces et main d'œuvre). Bols et systèmes d'insonorisation disponibles.

One-piece dishwasher-safe removable jar pad. Limited three year motor and two year parts and labor warranty. All units available with the following jars and sound enclosures.

Stossdämpfereinheit aus einem Stück, austauschbar und spülmaschinengeeignet. 3 Jahres Garantie (Motor) und 2 Jahre auf Material und Funktion. Behälter und Gehäuse mit Geräuschisolierung erhältlich.



Ideal para amasar masa de pan, montar claras, licuar sopas y batidos y mucho más. Ideal for whipped egg whites, soups, smoothies and everything in between. Idéal pour pain aux blancs d'œufs en neige, soupes, milk-shakes et plus encore. Ideal für durchzuführen, Durchkneten von Teigmassen, Eiweiss schlagen, Suppen verflüssigen, Mischen und vieles mehr.

ADAPTABLES A / ADJUSTABLES TO / ADAPTABLE À / PASSEND ZU:



**CAC95I**  
Jarra de copoliéster sin bisfenol A (BPA) de 2 L

2 L. BPA-free copolyester jar

Bol en copolyester sans BPA de 2 L

2 l. Behälter aus Copolyester ohne BPA

REF	U
CAC95I	1



**CAC93XI**  
Jarra de copoliéster sin bisfenol A (BPA) de 1,4 L

1,4 L BPA-free copolyester jar

Bol en copolyester sans BPA de 1,4 L

1,4 l. Behälter aus Copolyester ohne BPA

REF	U
CAC93XI	1



**SE1000**  
Compatible con todas las batidoras de vaso Waring® Commercial Xtreme de 2 L

Commercial Xtreme. Retrofits all blenders in Waring® Commercial Xtreme Series - 2 L containers

Compatible avec tous les blenders de 2 L de la gamme Waring® Commercial Xtreme

Geeignet für alle 2 l. Standmixer Waring® Commercial Xtreme.

REF	U
SE1000	1



**SE500**  
Compatible con todas las batidoras de vaso Waring® Commercial Xtreme de 1,4 L

Retrofits all blenders in Waring® Commercial Xtreme Series - 1,4 L containers

Compatible avec tous les blenders 1,4 L de la gamme Waring® Commercial Xtreme.

Geeignet für alle 1,4 l. Standmixer Waring® Commercial Xtreme.

REF	U
SE500	1



BATIDORAS PARA ALIMENTOS & CÓCTELES / FOOD & BAR BLENDERS / BOLS MIXEURS / ESSENS- U. GETRÄNKEMIXER



UNA BATIDORA DE VASO PARA CADA NECESIDAD /  
A BLENDER FOR EVERY NEED /  
UN BLENDER POUR TOUS LES BESOINS /  
EIN STANDMIXER FÜR JEDES BENÖTIGNIS



Batidora de vaso para cócteles  
Bar Blender  
Blender de bar  
Barcocktailstandmixer



**BLADE**  
Batidoras de vaso profesionales  
NuBlend Commercial Blenders  
Blenders professionnels NuBlend  
NuBlend professioneller  
Standmixer



**TORQ**  
2.0  
Torq Series



**PREP XTREME**  
Batidoras de vaso de servicio pesado  
Heavy Duty Blenders  
Blenders haute puissance  
Hochleistungsstandmixer



Batidoras de vaso de 4 L  
4-Liter Food Blenders  
Blenders de 4 L  
4 Liter Standmixer

BEBIDAS POR DÍA / DRINKS PER DAY / BOISSONS - JOUR / GETRÄNKE PRO TAG

1 - 25

25 - 49

50 - 74

75 +

100 +

USO Y SERVICIO / USAGE AND APPLICATION TYPE / UTILISATION / GEBRAUCH UND EINSATZMÖGLICHKEIT

Preparación de bebidas Servicio ligero a mediano	Preparación de alimentos y bebidas Servicio ligero a mediano	Preparación de alimentos y bebidas Servicio mediano a pesado	Preparación de bebidas y alimentos Servicio pesado	Preparación de alimentos Servicio pesado
Light to Medium Beverage Prep	Light to Medium Food and Beverage Prep	Medium to Heavy Food and Beverage Prep	Heavy Food and Beverage Prep	Heavy Food Prep
Préparation de boissons Usage léger à moyen	Préparation de boissons et culinaire, usage léger et moyen	Préparation de boissons et préparation culinaire Usage moyen à intensif	Préparation de boissons et préparation culinaire Usage intensif	Préparation culinaire Usage intensif
Zubereitung von Getränken Gering- oder Mittelgebrauch	Zubereitung von Lebensmittel und Getränken Gering- oder Mittelgebrauch	Zubereitung von Lebensmittel und Getränken Mittel- und Vielgebrauch	Zubereitung von Lebensmittel und Getränken Vielgebrauch	Zubereitung von Lebensmittel Vielgebrauch

IDEAL PARA / GREAT FOR USE IN / TYPES DE COMMERCE / IDEAL FÜR

Bares	Bares, restaurantes pequeños y heladerías	Bares, restaurantes y heladerías	Heladerías, cafeterías, restaurantes, bares, establecimientos de cuidado de la salud, escuelas, instituciones	Restaurantes grandes, establecimientos de cuidado de la salud, escuelas, instituciones
Bars	Bars, Small Restaurants, Smoothie Shops	Bars, Restaurants, Smoothie Shops	Smoothie Shops, Coffee Shops, Restaurants, Bars, Healthcare, Schools, Institutions	Large Restaurants, Healthcare, Schools, Institutions
Bars	Bars, petits restaurants, commerces de jus de fruits frais	Bars, restaurants, commerces de jus de fruits frais	Bars/Commerces de jus de fruit, salons de thé, restaurants, centres de remise en forme, établissements scolaires ou médicaux, institutions	Restaurants, brasseries, établissements scolaires ou médicaux, institutions
Bars	Bars, kleine Restaurants und Eisdielen	Bars, Restaurants und Eisdielen	Eisdielen, Bsitros, Restaurants, Bars, Wellnesseinrichtungen, Schulen, Institute	Grosse Restaurants, Wellnesseinrichtungen, Schulen, Institute

APLICACIONES RECOMENDADAS / RECOMMENDED APPLICATIONS / IDÉAL POUR LA PRÉPARATION DE / IDEAL FÜR DIE ZUBEREITUNG VON

Bebidas heladas, batidos de fruta, margaritas y mucho más	Cócteles helados, batidos de helado, salsas frías y calientes, aderezos y más	Margaritas, daiquiris, granitas, salsas, sopas y más	Batidos de fruta, bebidas de café helado, cócteles helados, salsas, aderezos, sopas, postres, aliños y mucho más	Aliños, salsas, aderezos, sopas y más
Frozen Drinks, Smoothies, Margaritas and More	Frozen Cocktails, Ice Cream Drinks, Dips, Salsas, Sauces and More	Margaritas, Daiquiris, Granitas, Sauces, Soups and more	Fruit Smoothies, Iced Coffee Drinks, Frozen Cocktails, Salsas, Sauces, Soups, Desserts, Dressings and more	Dressings, Salsas, Sauces, Soups and More
Milkshakes, boissons glacées, cocktails, Margaritas, etc.	Boissons glacées, milkshakes, cocktails, sauces, etc.	Margaritas, Daiquiris, Granitas, sauces, soupes, etc.	Smoothies, café glacé, cocktails glacés, sauce, crèmes, soupes, desserts, vinaigrettes, etc.	Vinaigrettes, sauces, crèmes, soupes, etc.
Gefrorene Getränke, Fruchtcocktails, Magaritas und vieles mehr	Eiscocktails, Eishakes, kalte und heisse Sossen, Dressings und vieles mehr	Magaritas, Daiquiris, Granitas, Sossen, Suppen und vieles mehr	Fruchtcocktails, gefrorene Kaffegetränke, Eiscocktails, Sossen, Nachtisch, Dressings und vieles mehr	Dressing, Sossen, Suppen und vieles mehr

MAQUINARIA /  
MACHINERY /  
MACHINES



Ref. WDM120E  
16000 RPM



Ref. WDM360E  
25000 RPM



Ref. CAC20



INCLUYE VASOS DE ACERO INOXIDABLE /  
INCLUDES STAINLESS STEEL MALT BEVERAGE CUPS /  
INCLUT DES GOBELETS EN ACIER INOXYDABLE /  
INKLUSIVE EDELSTAHLBEHÄLTER

## WDM120E / WDM360E

Batidora para batidos / Drink Mixers /  
Shaker électrique / Getränkemixer

REF	Lts	W	U
WDM120E	0,80	1 HP / 740 W	1
WDM360E	0,80	1 HP / 740 W	1

Incluye un agitador de aletas, un agitador macizo y un vaso de acero inoxidable. Potente motor comercial, reemplazable por el usuario.

Includes solid and butterfly and removable agitator and stainless steel malt beverage cup. Powerful, user-replaceable commercial motor.

Inclut un agitateur plein, un agitateur à ailettes et un gobelet en acier inoxydable. Puissant moteur commercial remplaçable par l'utilisateur.

Inklusive Schmetterlingsmischer, massiver Mixer und Edelstahlbehälter. Starker professioneller Motor durch den Benutzer austauschbar.

3600 RPM - 1,4 A



## 6001X

Licuadora de servicio pesado / Heavy-Duty Juice Extractor /  
Centrifugeuse à usage intensif / Hochleistungs Entsafter

REF	V	W	Hz	U
6001X	230	330	50	1

Cuchilla flotante de acero inoxidable, para extraer el zumo y eliminar la pulpa rápidamente.

Stainless steel blade speeds up juice flow with faster distribution of pulp.

Lame flottante en acier inoxydable qui extrait le jus rapidement, réduisant ainsi la quantité de pulpe.

Messer aus rostfreiem Stahl, zum schnellen Entsaften und Fruchtfleiscentfernung.

8,00 - 10,00 L

Preparación máxima horaria / Maximum hourly preparation /  
Préparation maximum horaire / Maximierte stündliche Zubereitung

## BJX240

Exprimidora para bares / Bar juicer / Presse-agrumes de bar / Fruchtpresse für Bars

0,5 A



REF	V	W	Hz	U
BJX240	230	110	50	1

Incluye un vaso de 1 L (no enseñado). 120 naranjas/h.

Includes 1 L serving container (not shown). 120 oranges/h.

Inclut un récipient de 1 L pour servir le jus (non montré). 120 oranges/h.

Inclusive 1 L Behälter (nicht gezeigt). 120 Orangen/h.

## WKS800E

Afilador de cuchillos comercial / Commercial Knife Sharpener  
Aiguiser électrique commercial / Kommerzieller Messerschärfer



REF	V	W	Hz	A	U
WKS800E	230	25	50/60	0,1	1

Dos ruedas de afilar (fino/grueso) y una rueda de pulir. Afila a un ángulo de 18-22 °, el ángulo recomendado por los fabricantes de cuchillos.

La rueda de pulir gira en dirección opuesta para remover las asperezas en el filo del cuchillo de manera óptima y lograr un pulido más efectivo

Two grinding wheels (fine/coarse), one stropping wheel. Grinds at 18-22° angles — optimum angles recommended by knife manufacturers. Stropping wheel also operates in reverse direction, allowing for a more efficient removal of burrs and polishing of the blade.

Deux meules d'affûtage (grains fins/grossiers) et une meule de polissage. Aiguise à un angle de 18-22°, l'angle recommandé par les fabricants de couteaux.

La meule de polissage tourne dans les deux sens, pour un meilleur affilage.

Zwei Schärfräder (fein/grob) und ein Polierrad. Schärfwinkel 18-22°, von den Messerhersteller empfohlen. Das Polierrad dreht sich in der entgegengesetzten Richtung, um die Schärfrückstände optimal zu entfernen und um eine effiziente Polierung zu erreichen.

**WSG30E** Molinillo de especias profesional / Professional Electric Spice Grinder / Moulin à épices professionnel / Professionelle Gewürzmühle

19000 RPM - 0,76 A



Ref. CAC103



REF	V	W	Hz	Lts	U
WSG30E	230	175	50	0,40	1

Acción de pulso para controlar precisamente la consistencia de las especias. Incluye tres recipientes de acero inoxidable con tapas, aptos para lavavajillas.

Action intermittente, pour davantage de contrôle. Inclut trois récipients en acier inoxydable avec couvercles, compatibles lave-vaisselle.

PULSE actuation to easily manage consistency of grind. Includes 3 fully removable and dishwasher-safe stainless steel grinding bowls with convenient storage lids.

Pulsefunktion um die perfekte Konsistenz der Gewürze zu kontrollieren. Inklusive 3 Edelstahlbehälter mit Deckeln, spülmaschinengeeignet.

**WSG60E** Molinillo profesional - seco & húmedo / Professional grinder - dry & wet / Moulin professionnel - sec & humide / Professionelle Mühle - trocken und feucht

25000 RPM - 3 A



REF	V	W	Hz	Lts	U
WSG60E	230	200	50	0,70	1

Carcasa de alta resistencia de aluminio de fundición. Incluye tres recipientes. Bloqueo de seguridad de la carcasa superior. Cuchillas de acero inoxidable durables. Incluye dos recipientes de acero inoxidable con tapas, aptos para lavavajillas.

Carcasse haute résistance en fonte d'aluminium. Muni de trois récipients. Blocage de sécurité de la carcasse supérieur. Lames en acier inoxydable durables. Muni de deux récipients en acier inoxydable à couvercles, va au lave-vaisselle.

High-strength aluminium casing. It includes three containers. Upper housing safety lock upper. Durable stainless steel blades. It includes two stainless steel containers with lids, dishwasher safe.

Strapazierfähiges Aluminiumgehäuse. Beinhaltet drei Behälter. Behälter mit leistungsfähigerem Sicherheitsverschluss. Haltbare Edelstahlklingen. Zwei Stahlbehälter mit Deckel, spülmaschinenfest sind eingeschlossen.

**IDEA!** Perfecto para los granos de pimienta, canela, nueces, ajo, hierbas y otras mezclas secas y húmedas / Perfect for peppercorns, cinnamon, nuts, garlic, herbs, and other dry and wet blends / Parfait pour grains de poivre, cannelle, noix, ail, herbes et autres mélanges secs et humides / Perfekt für Pfefferkörner, Zimt, Walnüsse, Knoblauch, Kräutern und andere trockene und feuchte Mischungen

**IC70E** Tritrador de hielo profesional / Professional ice crusher / Broyeur à glace professionnel / Professioneller Eiscrusher

0,22 Kg / min  
13,6 Kg / h



REF	V	W	Hz	A	U
IC70E	240	0,5 HP / 240 W	50	1,5	1

Función START&STOP automática. Capacidad para 2.8 litros de hielo triturado. Admite sólo cubitos inferiores a 45 g.

Function START&STOP automatique. Bac à glace d'une capacité de 2,8 L. Pour des glaçons de moins de 45g.

Automatic START&STOP operation. Container holds up to 2.8 liters of crushed ice. Only admit ice cubes smaller than 45g.

Automatische START&STOP Funktion. Fassungsvermögen von 2,8 Liter gecrashtem Eis. Lässt nur Würfel bis zu 45g zu.





Freidoras equipadas con un termostato EGO, un termostato de seguridad, luces piloto indicadoras y zona fría.

Las unidades de calentamiento se quitan y ponen fácilmente para facilitar la limpieza. Temperatura variable hasta 190 °C.

Las cubas llevan asas entrantes móviles (15070, 15071, 15000, 15001).

The deep fat fryers equipped with EGO thermostat, thermal cut-out, indicator lights, cold zone.

The heating unit is easily removable and thus facilitating maintenance and cleaning.

Variable temperature control up to 190 °C.

Removable inner pan with recessed handles (15070, 15071, 15000, 15001).

Les friteuses sont équipées d'un thermostat EGO, un thermostat de sécurité, des voyants lumineux et une zone froide.

Resistance amovible pour faciliter le nettoyage. Température variable jusqu'à 190 °C.

Les cuves, avec anses pliables, sont amovibles (15070, 15071, 15000, 15001).

Fritteuse hergestellt ausgestattet mit EGO-Thermostat, ein Sicherheitsthermostat, Kontrolllichter und kalte Zone.

Zur besseren Reinigung lassen sich die Hitzelemente einfach herausnehmen und zusammenbauen.

Variable Temperatur bis 190 °C.

Die Frittierkörbe werden mit abnehmbaren Griffen geliefert (15070, 15071, 15000, 15001).



FREIDORAS / FRYERS / FRITEUSES / FRITTEUSE

**P15070** Freidora 5 lts / 5 lts fryer /  
Friteuse 5 lts / 5 Liter Fritteuse

INOX - ST/STEEL  
EDELSTAHL  
18/10



REF	Lts	V	W	U
P15.070	5,00	230	2000	1

Medida cesta / Basket size / Mesure panier / Frittierkorbgröße 21 x 14 x 12,5 cm

**P15071** Freidora 5+5 lts / 5+5 lts fryer /  
Friteuse 5+5 lts / 5+5 Liter Fritteuse

INOX - ST/STEEL  
EDELSTAHL  
18/10



REF	Lts	V	W	U
P15.071	5,00+5,00	2 x 230	2 x 2000	1

Medida cesta / Basket size / Mesure panier / Frittierkorbgröße 21 x 14 x 12,5 cm

**P15000** Freidora 8 Lts / 8 Lts Fryer /  
Friteuse 8 Lts / 8 Liter Fritteuse

INOX - ST/STEEL  
EDELSTAHL  
18/10



REF	Lts	V	W	U
P15.000	8,00	230	3250	1

Medida cesta / Basket size / Mesure panier / Frittierkorbgröße 24 x 18 x 14 cm

**P15001** Freidora 8+8 Lts / 8+8 Lts Fryer /  
Friteuse 8+8 Lts / 8+8 Liter Fritteuse

INOX - ST/STEEL  
EDELSTAHL  
18/10



REF	Lts	V	W	U
P15.001	8,00+8,00	2 x 230	2 x 3250	1

Medida cesta / Basket size / Mesure panier / Frittierkorbgröße 24 x 18 x 14 cm

**P15002** Freidora 8 Lts con grifo de vaciado /  
8 Lts fryer with drainage tap /  
Friteuse 8 Lts avec robinet vidange /  
8 Liter Fritteuse mit Ablaufhahn

INOX - ST/STEEL  
EDELSTAHL  
18/10



REF	Lts	V	W	U
P15.002	8,00	230	3250	1

Medida cesta / Basket size / Mesure panier / Frittierkorbgröße 24 x 18 x 14 cm

**P15003** Freidora 8+8 Lts con grifo de vaciado /  
8+8 Lts fryer with drainage tap /  
Friteuse 8+8 Lts avec robinet vidange /  
8+8 Liter Fritteuse mit Ablaufhahn

INOX - ST/STEEL  
EDELSTAHL  
18/10



REF	Lts	V	W	U
P15.003	8,00+8,00	2 x 230	2 x 3250	1

Medida cesta / Basket size / Mesure panier / Frittierkorbgröße 24 x 18 x 14 cm







CAUTION - HOT SURFACES

WARING  
COMMERCIAL  
C-TS  
CONVECTOR TOASTING  
SYSTEM

POWER ON  
READY

ON

OFF

TOASTER LIGHTER

1 2 3 4 5 6 7 8 9

CONVECTION

WARING

RFI  
COMPLIANT

**P15042** Tostadora continua / Conveyor toaster / Toasteur convoyeur / Durchlauf toaster

INOX - ST/STEEL  
EDELSTAHL  
18/10

REF	TIPO / TYPE	A x B x C cm	Cap. Max	V	W	U
P15.042	200	37 x 39 x 39	500 u/h	230	1940	1



El color de las tostadas puede determinarse por la velocidad de la banda transportadora, así como por las resistencias superior e inferior que se controlan independientemente. El aparato está completamente aislado para que emita un calor mínimo a su alrededor. El interruptor encendido-apagado contempla la posición extra de standby. La longitud de la banda transportadora permite 2 hileras de tostadas (tipo 200) y 3 hileras (tipo 300).

Toast colour can be determined by conveyor speed as well as by independently controlled heating elements. Units are fully insulated to emit only minimal heat to surroundings. Main switch with extra standby position. The toasters can be used for bread as well as for buns. The toasting belt is suitable for 2 rows for toast, 200 type and 3 rows, 300 type.

La couleur du pain se détermine par la vitesse de la bande de transport ainsi que par les résistances contrôlées indépendamment. Les appareils sont isolés entièrement et n'émettent qu'une chaleur minimale à la température ambiante. Interrupteur marche-arrêt qui inclut le mode veille standby. La Largeur de la bande de transport permet 2 rangées de tranches, type 200 et 3 rangées, type 300.

Die Farbe der Toasts kann durch die Geschwindigkeit des Laufbands bestimmt werden, sowie durch die oberen als auch durch die unteren Heizelementen, welche unabhängig voneinander kontrolliert werden können. Das Gerät ist komplett isoliert um die Umgebungstemperatur minimal zu beeinflussen. Ein/ Aus Schalter mit extra Standby Position. Die Breite des Laufbands erlaubt 2 Toastreihen (Typ 200) y 3 Toastreihen (Typ 300).

**CTS1000E** Tostadora comercial de servicio pesado con transportador / Heavy - Duty Commercial Conveyor Toaster / Grille - pain à convoyeur à usage intensif / Kommerzieller Hochleistungs - Durchlauf toaster



REF	V	W	A	U
CTS1000E	230	2700	11,25	1



Pre-calentamiento ultra rápido de 5 minutos.  
Ancha abertura de 5 cm para tostar rebanadas gruesas y panecillos.  
Modo de espera para ahorrar energía.  
Transportador con velocidad variable.  
Permite tostar por una sola cara.

Ultra-fast, 5-minute heat-up time.  
Large 5 cm opening accommodates thick breads and bagels.  
Energy-saving standby function  
Conveyor speed control to suit all toasting preferences.  
Allows toasting on one side only.

Mise à température rapide (5 minutes).  
Ouverture de 5 cm, pour les tranches épaisses.  
Mode veille pour économiser de l'énergie.  
Convoyeur à vitesse variable.  
Permet de griller d'un seul côté.

Ultra schnelle Vorerhitzung von 5 Minuten. Öffnungshöhe von 5 cm zum Toasten von dicken Scheiben und Brötchen. Energiesparende Standby Funktion.  
Laufband mit regulierbarer Geschwindigkeit.  
Einseitiger Toaster.



**P15038** Tostadora / Sandwich toaster / Toasteur / Sandwichtoaster

INOX - ST/STEEL  
EDELSTAHL  
18/10



REF	V	W	U
P15.038	230	1700	1

Las resistencias se pueden controlar por separado. Con temporizador y bandeja limpieza recoge migas. 4 tubos de cuarzo.

Les résistances se contrôlent séparément. Avec minuterie, tiroir ramasse miettes et 4 tubes quartz.

Heating elements separately controllable. With timer, drip tray and 4 quartz heating elements.

Unabhängig steuerbare Hitzestäbe. Mit Timer und reinigbarer Krümelplatte, 4 Quarzrohre.

Se entregan con 3 pinzas para sandwich /  
Delivered with 3 sandwich tongs /  
Livrées avec 3 pinces à sandwich /  
Lieferung mir 3 Sandwichzangen

**P15039** Tostadora / Sandwich toaster / Toasteur / Sandwichtoaster

INOX - ST/STEEL  
EDELSTAHL  
18/10



REF	V	W	U
P15.039	230	3000	1

2 niveles. Las resistencias funcionan por separado. Con temporizador, bandeja recoge migas. 6 tubos de cuarzo.

2 niveaux. Les résistances se contrôlent séparément. Avec minuterie, tiroir ramasse miettes et 6 tubes quartz.

2 levels. Heating elements separately controllable. With timer, drip tray and 6 quartz heating elements.

2 Ebenen. Unabhängig steuerbare Hitzestäbe. Mit Timer und reinigbarer Krümelplatte, 6 Quarzrohre.

Se entregan con 6 pinzas para sandwich /  
Delivered with 6 sandwich tongs /  
Livrées avec 6 pinces à sandwich /  
Lieferung mir 6 Sandwichzangen

**P15040 / P15041** Tostadora / Toaster / Toasteur / Toaster



REF	RANURAS / SLOTS / FENTES / SCHLITZE	V	W	U
P15.040	4	230	2000	1
P15.041	6	230	3000	1

Ref. 15040



Fabricada en acero inoxidable.  
Con conmutador ahorro energía para decidir la cantidad de rebanadas a tostar.  
2 ó 4 (ref.15040) / 3 ó 6 (ref.15041).  
Con temporizador.  
Ranura: 2,5 x 14,5 x 14,5 cm.

Habillage en acier inoxydable.  
Avec commutateur économiseur pour choisir le nombre de tranches à griller:  
2 ou 4 (ref. 15040) / 3 ou 6 (ref. 15041).  
Avec minuterie.  
Fente: 2,5 x 14,5 x 14,5 cm.

All St/Steel construction.  
With energy-saving switch to decide how many slices to toast.  
2 or 4 (ref.15040) / 3 or 6 (ref.15041).  
With timer.  
Slot: 2,5 x 14,5 x 14,5 cm.

Hergestellt aus rostfreiem Stahl.  
Mit energiesparendem Schalter um die Anzahl der zu toastenden Scheiben zu bestimmen. 2 oder 4 (Art.Nr.15040) / 3 oder 6 (Art. Nr.15041). Mit Timer.  
Schlitz: 2,5 x 14,5 x 14,5 cm.

Ref. 15041



**WCT708E** Tostadora de servicio mediano de 4 rebanadas / 4 - Slice Medium - Duty Toaster / Grille - pain à usage moyen / 4 Scheiben Mittelleistung Toaster



REF	RANURAS / SLOTS / FENTES / SCHLITZE	V	W	Hz	A	U
WCT708E	4	230	1800	50	7,8	1



Ranura: 3,5 x 13,5 x 13,5 cm.  
225 rebanadas por hora.  
Con expulsión automática.  
Slot: 3,5 x 13,5 x 13,5 cm.  
225 slices per hour.  
With pop up system.

Fente: 3,5 x 13,5 x 13,5 cm.  
Capacité de 225 tranches/heure.  
Avec éjection automatique.  
Schlitz: 3,5 x 13,5 x 13,5 cm.  
Automatischer Auswurf.  
225 Scheiben pro Stunde.





GRILL DE CONTACTO / CONTACT GRILL / GRILL DE CONTACT / KONTAKTGRILL

Planchas de fundición.  
 \*Ranuras arriba y abajo.  
 Tiempo de precalentamiento muy breve.  
 Bandeja y recoge jugos.  
 Borde antisalpicaduras.  
 Luces piloto.  
 Termostato ajustable hasta 300 °C.

Cast iron griddle plates.  
 \*Both plates with parallel grooves.  
 Short warming-up time.  
 Large drip tray.  
 High turned-up spatter rim.  
 Indicator lights.  
 Adjustable thermostat to 300 °C.

Plaque en fonte.  
 \*Rainures en bas et en haut.  
 Mise à température rapide.  
 Tiroir de propreté.  
 Bourdure anti projections haute.  
 Voyants lumineux.  
 Thermostat réglable jusqu'à 300 °C.

Grillplatten aus Gusseisen.  
 \*Rillen oben und unten.  
 Sehr kurze Aufwärmzeit.  
 Fettauffangschale.  
 Seiten mit Antispritzschutz.  
 Kontrollleuchten.  
 Einstellbares Thermostat bis 300 °C.



Ref. 818.000

Incluido en el precio / Included on the price /  
 Inclus dans le prix / Inklusiv im Preis

**P15004**

Grill de contacto "SOLO COMPACT" /  
 "SOLO COMPACT" Contact grill /  
 Grill de contact "SOLO COMPACT" /  
 "SOLO COMPACT" Kontaktgrill



INOX - ST/STEEL  
 EDELSTAHL  
 18/10



REF	Superficie de cocción / Cooking surface / Surface de cuisson / Grillplattenfläche cm	V	W	U
P15.004*	22 x 23	230	1800	1

**P15005**

Grill de contacto "SOLO GRANDE" /  
 "SOLO GRANDE" Contact grill /

**P15006**

Grill de contact "SOLO GRANDE" /  
 "SOLO GRANDE" Kontaktgrill



INOX - ST/STEEL  
 EDELSTAHL  
 18/10



REF	Superficie de cocción / Cooking surface / Surface de cuisson / Grillplattenfläche cm	V	W	U
P15.005*	32 x 21	230	2200	1
P15.006	32 x 21	230	2200	1

**P15007**

Grill de contacto "DUETTO COMPACT" /  
 "DUETTO COMPACT" Contact grill /

**P15008**

Grill de contact "DUETTO COMPACT" /  
 "DUETTO COMPACT" Kontaktgrill



INOX - ST/STEEL  
 EDELSTAHL  
 18/10



REF	Superficie de cocción / Cooking surface / Surface de cuisson / Grillplattenfläche cm	V	W	U
P15.007*	47 x 23	230	3600	1
P15.008	47 x 23	230	3600	1

**P15009**

Grill de contacto "DUETTO GRANDE" /  
 "DUETTO GRANDE" Contact grill /

Grill de contact "DUETTO GRANDE" /  
 "DUETTO GRANDE" Kontaktgrill



INOX - ST/STEEL  
 EDELSTAHL  
 18/10



REF	Superficie de cocción / Cooking surface / Surface de cuisson / Grillplattenfläche cm	V	W	U
P15.009*	2 x (32 x 21)	2x230	2x2200	1



GRILL DE CONTACTO / CONTACT GRILL / GRILL DE CONTACT / KONTAKTGRILL

Placa superior articulada y auto-equilibrada, para acomodar piezas gruesas de hasta 7,5 cm.  
Termostato ajustable hasta 300 °C.

Hinged self-balancing top plate to accommodate foods up to 7,5 cm thick.  
Adjustable thermostat to 300 °C.

Charnière flottante qui s'adapte à l'épaisseur des aliments (jusqu'à 7,5 cm).  
Thermostat réglable jusqu'à 300 °C.

Obere Grillplatte beweglich und selbsteinstellend, um sich dicken Stücken bis zu 7,5 cm selbst anzupassen.  
Einstellbares Thermostat bis 300 °C.



Ref. CAC105

Incluido en el precio / Included on the price  
Inclus dans le prix / Inklusiv im Preis

Parrilla/Sandwichera compacta /  
Compact Panini Grill /  
Grill/Presse - panini compact /  
Kompakter Sandwichgrill

WPG150E



REF	Superficie de cocción / Cooking surface / Surface de cuisson / Grillplattenfläche cm	V	W	U
WPG150E	24 x 23,5	230	2000	1

Parrilla/Sandwichera grande /  
Large Panini Grill /  
Grand grill/presse - panini /  
Grosser Sandwichgrill

WPG250E



REF	Superficie de cocción / Cooking surface / Surface de cuisson / Grillplattenfläche cm	V	W	U
WPG250E	37 x 28	230	2400	1

Borde antisplacaduras alto.  
Máximo aprovechamiento de la superficie de la plancha.  
Termostato de la superficie con dos pilotos de control y bandeja recoge grasas incorporada.  
Termostato ajustable hasta 300 °C.

High anti-splash upstand.  
Two indicators lights, thermostat and build-in fat dripping tray.  
Adjustable thermostat to 300 °C.

Avec bords anti-éclaboussement.  
Profit maximum de la plaque.  
Thermostat, deux voyants de contrôle et bac ramasse-graisse.  
Thermostat réglable jusqu'à 300 °C.

Hohen Antipritzschutzeiten.  
Maximale Nutzung der Grillfläche.  
Oberflächenthermostat mit zwei Kontrollleuchten und eingebauter Fettauffangschale.  
Einstellbares Thermostat bis 300 °C.

Plancha eléctrica lisa /  
Electric griddle plain /  
Plaque électrique unie /  
Elektrische Grillplatte

P15084



INOX - ST/STEEL  
EDELSTAHL  
18/10



REF	DIMENSIONES PLANCHA mm / DIMENSIONS GRIDDLE mm / DIM.SUPERFICE TRAVAIL mm / DIMENSIONEN GRILLFLÄCHE mm /	V	W	U
P15.084	400 x 400	230	3000	1

Plancha eléctrica 1/2 lisa - 1/2 ranurada /  
Electric griddle 1/2 plain - 1/2 grooved /  
Plaque électrique 1/2 unie - 1/2 rainurée /  
Elektrische Grillplatte 1/2 glatt - 1/2 gerillt

P15086



INOX - ST/STEEL  
EDELSTAHL  
18/10



REF	DIMENSIONES PLANCHA mm / DIMENSIONS GRIDDLE mm / DIM.SUPERFICE TRAVAIL mm / DIMENSIONEN GRILLFLÄCHE mm /	V	W	U
P15.086	400 x 400	230	3000	1

## P688085 Hervidor de arroz / Rice cooker / Cuiseur à riz / Reiskocher



REF	Ø cm	Lts	H	V	W	ARROZ / RICE / RIZ / REIS Kg	U
P688.085	46	5,40	40	220-230/50Hz	1950	9,8	1
P688.087	56	8,20	40	230/50Hz	2500	15	1



Ref: 688.085



Ref: 688.087

## P15036 Salamandra con parte superior regulable / Salamander with adjustable top / Salamandre hauteur réglable / Salamander mit regulierbarem Oberteil



INOX - ST/STEEL  
EDELSTAHL  
18/10



Ref	Grill cm	V	W	U
P15.036	44 x 33	230	3000	1

Con bandeja limpieza, rejilla cromada móvil y regulador de temperatura /

Avec tiroir de propreté, grille chromée amovible et régulateur de température

With dripping tray, heavy chrome-plated grid and adjustable temperature switch /

Mit Reinigungsblech, herausnehmbaren Chromrost und Temperaturregler.

## P15044 Máquina para cocer pasta con grifo de desagüe / Pasta cooker with drainage tap / Cuiseur à pâtes avec robinet vidange / Nudelkocher mit Ablaufhahn



REF	Lts	V	W	U
P15.044	25,00	230	3250	1

Con 3 cestas de malla fina: 1 de 145 x 280 x 175 (H) mm y 2 de 145 x 145 x 175 (H) mm.

Avec 3 corbeilles à mailles fines. 1-145 x 280 x 175 (H) mm et 2-145 x 145 x 175 (H) mm

With 3 fine mesh baskets, 1-145 x 280 x 175 (H) mm and 2-145 x 145 x 175 (H) mm

Mit 3 feinmaschigen Nudelsieben: 1-145 x 280 x 175 (H) mm und 2-145 x 145 x 175 (H) mm

**PLACAS INDUCCIÓN AHORA ES  
VOLLRATH**

**INDUCTION HOBS IS NOW  
VOLLRATH**

**PLAQUES INDUCTION EST MAINTENANT  
VOLLRATH**

**INDUKTIONSKOCHFELDER IST JETZT  
VOLLRATH**



VER PRODUCTOS EN / SEE PRODUCTS ON / VOIR PRODUITS EN / SIEHE PRODUKTE IN **P. 96**

**BAÑO MARÍA AHORA ES  
VOLLRATH**

**BAIN MARIE IS NOW  
VOLLRATH**

**BAIN MARIE EST MAINTENANT  
VOLLRATH**

**WASSERBAD IST JETZT  
VOLLRATH**



VER PRODUCTOS EN / SEE PRODUCTS ON / VOIR PRODUITS EN / SIEHE PRODUKTE IN **P. 73**

HORNOS Y MICRO-ONDAS / OVENS & MICRO-WAVES /  
FOURS ET MICRO-ONDES / BACKÖFEN UND MIKROWELLEN

**P6881** Horno convección función vapor / Convection oven with steam function /  
Four à air pulsé avec fonction vapeur / Konvektionsbackofen mit Dampfgarfunktion



REF	CAP.	V	W	U
P688.150	4 x 2/3 GN	230	2500	1



Interruptor de selección para convección, vapor o combinación vapor/convección. Termostato max. 200°C. Reloj 120 minutos.

Switch for convection, steam or combination steam/convection and defrost function. Thermostat max. 200 °C. Timer 120 minutes.

Bouton de réglage convection, vapeur or une combinaison de ces 2 systèmes. Fonction décongélation. Thermostat 200°C max. 120 minutes.

Schalter für die Auswahl Konvektion, Dampf oder Kombination Dampf/Konvektion. Thermostat max. 200°C. Timer 120 Minuten.

**P15035** Horno multifuncional de convección / Convection oven /  
Four à air pulse / Multifunktioneller Konvektionsbackofen



REF	REJILLA / GRILL / GRILLE / ROST	V	W	U
P15.035	43 x 32	230	2670	1

4 rejillas incluidas / 4 grids included / 4 grilles incluses / 4 Roste inklusive



Temporizador, pilotos luminosos, termostato (max. 300 °C), termostato de seguridad y doble vidrio anti-quemaduras.

Timer, indicator lights, thermostat, (max. 300 °C) thermal cut-out and double glass.

Avec minuterie, voyants lumineux, thermostat (max. 300 °C), thermostat de sécurité et avec double vitre. mostat, thermostat de sécurité et avec vitre double.

Timer, Kontrollleuchten, Thermostat (max. 300 °C), Sicherheitsthermostat und Doppelglas gegen Verbrennungen.



**P688**

Microondas profesional "magnetron" / "magnetron" professional micro - waves /  
Four micro - ondes professionnel "magnetron" / Professionelle "magnetron" Mikrowelle



OUTPUT 1800 W

INOX - ST/STEEL  
EDELSTAHL



REF	Lts	Kg	Dim int / Inner sizes / Dim. int. / Innenmasse cm	V	W	U
P688.010	30,00	35	39 x 37 x 19	230	2800	1

2 magnetrones / 2 magnetrons /  
2 magnétrons / 2 Magnetrones

10 Programas. 3 Velocidades. Programa descongelación  
10 Program options. 3 Speeds. Defrost system  
10 Programmes. 3 Puissances. Décongélation  
10 verschiedenen Programmen. Drei Geschwindigkeiten

Contiene / Contents / Livré:

Fuente cerámica + bandeja 39x37 cm  
Ceramic plate + tray of 39x37 cm  
Plaque céramique + plaque 39x37 cm  
Keramische Platte +Zwischentablett von 39x37 cm.

**P15080**

Microondas combi / Combi micro - wave / Four micro - ondes / Kombi - Mikrowelle



REF	Lts	Dim int / Inner sizes / Dim. int. / Innenmasse cm	V	Max W	U
P15.080	23,0	31,5 x 31,5 x 19	230	2400	1

Output / Ausgangsleistung: 800 W  
Grill: 1200 W  
Convección / Convection / Konvektion: 1200 W

Ø plato giratorio / glass round dish /  
Plateau tournant / Drehplatte 27 cm

Funciones: descongelar, gratinar y calentar  
Functions: defrosting, baking and heating  
Fonctions: décongeler, gratter et chauffer  
Funktionen: Auftauen, überbacken und erhitzen

MAQUINARIA PARA CHOCOLATE / MACHINES FOR CHOCOLATE /  
MACHINES POUR LE CHOCOLAT / MASCHINEN FÜR SCHOKOLADE

**P15096** Fuente Fondue chocolate / Chocolate fountain / Fontaine à chocolat / Schokoladenbrunnen

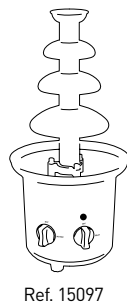
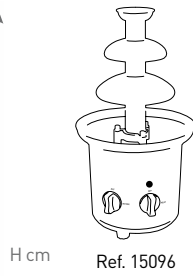

REF	ml	NIVELES / LEVELS / NIVEAUX / EBENEN	V	Hz	Ø cm	H cm	W	U
P15.096	700	3	230	50	21	38,0	250	1
P15.097	1200	4	230	50	23	45,0	250	1

Cuerpo y partes de acero inoxidable. Incorpora un regulador de temperatura y un regulador de velocidad. Muy fácil de desmontar y limpiar. Pie regulador para apoyo estable.

St/Steel body and parts. Temperature and speed control. Easy to clean. Adjustable foot for a stable standing.

Corps et composants en acier inoxydable. Regulateur température et vitesse. Très facile à nettoyer. Pied de régulation pour un appui stable.

Gehäuse und Teile aus rostfreiem Stahl. Eingebauter Temperatur- und Geschwindigkeitsregler. Einfach auseinander zu nehmen und zu reinigen. Regulierbarer Fuss für einen stabilen Stand.

**P15010** Baño maría chocolate / Chocolate warmer /  
Chauve-chocolat / Wasserbad



INOX - ST/STEEL  
EDELSTAHL  
18/10  
Temp. Max 40 °C



REF	UNIDADES / UNITS / UNITÉS / EINHEIT	Lts	V	W	U
P15.010	1	4,50	230	165	1

**IDEA!** Especial chocolate  
Special chocolate  
Spécial chocolat  
Spezial Schokolade

**P15075** Crêpera - Crêpera doble / Crêpe maker - double crêpe maker /  
Crêpière - Crêpière double / Crêpe - Doppelcrêpeisen

Termostato / Thermostat / Thermostat / Thermostat :

Temp. Max 300 °C

Ref. 15075



REF	Ø cm	cm	V	W	U
P15.075	40	45 x 49	230	3000	1

Acero inoxidable con planchas de hierro fundido teflonadas. Indicador temperatura, cajón y espátula.

St/Steel with cast iron teflon coated plates. Indicator light, drawer/warming tray and batter spreader.

Acier inoxydable avec plaques en fonte avec revêtement en téflon. Témoin de controle, tiroir/plaque chauffante et étaleur de pâte.

Rostfreier Stahl und Platten aus Teflon- Gusseisen. Temperaturanzeige, Schublade und Spachtel.



**WW180E / WW200E** Gofrera profesional / Heavy - duty waffle maker /  
Gaufrier professionnelle / Professionelles Waffleisen



Ref. WW180E



Ref. WW200E



REF	Cap. Max. día / day / journée / tag	Max. U	Tipo/Type	Ø cm	V	W	Hz	U
WW180E	25 u/h	100	sencilla/single	19,5	230	1200	50	1
WW200E	50 u/h	200	doble/double	19,5 x 2	230	1400	50	1

Moldes con triple capa antiadherente, para retirar fácilmente los gofres y limpiar rápidamente el aparato.

Triple-coated nonstick plates allow for easy removal of waffle and quick cleanup.

Plaques à triple revêtement antiadhésif, pour retirer facilement les gaufres et nettoyer rapidement.

Formen mit dreifacher Antihftbeschichtung, um die Waffeln einfach abzulösen und für eine einfache und schnelle Reinigung.

**WWCM180E** Máquina profesional para hacer conos de galleta /  
Professional machine for making waffle cones /  
Machine professionnelle pour faire des cônes en biscuit /  
Gewerbliche Maschine zur Herstellung von Waffeltüten



Ref. CAC121



REF	Cap. Max.	Tipo/Type	Ø cm	V	W	Hz	U
WWCM180E	60 u/h	sencilla/single	19	230	1200	50	1

Resistente base de fundición. Placas con triple capa antiadherente. Indicadores de "encendido", "listo para cocer" y "listo para comer".

Durable cast-iron base. Plates with triple non-stick layer. "Power on", "ready to cook" and "ready to eat" indicators.

Résistant base en fonte. Plaques à triple couche anti-adhérente. Voyants "allumage", "prêt à cuire" et "prêt à manger".

Solides Gusseisengestell. Dreifach-antihftbeschichtete Platten. Signalleuchten: "ein", "kochbereit" und "gar/essfertig".









ESPAÑOL

NUEVA GAMA DE CARROS CALIENTES PARA BANQUETES Y CATERING, QUE LE PERMITIRÁN ACERCAR LA COCINA ALLÍ DONDE ESTÉ EL CLIENTE, ASEGURANDO LA MÁXIMA CALIDAD Y LA ENTREGA DE LOS PLATOS POR ENCIMA DE LOS 65 °C.

ENGLISH

NEW RANGE OF HEATED TROLLEYS FOR BANQUETS AND OTHER CATERING EVENTS, A RANGE THAT ENABLES YOU TO TAKE THE KITCHEN TO CUSTOMER, GUARANTEEING MAXIMUM QUALITY AND THE DELIVERY OF DISHES AT TEMPERATURES ABOVE 65 °C.

FRANÇAIS

NOUVELLE GAMME DE CHARIOTS CHAUDS POUR BANQUETS ET SERVICE TRAITEUR (CATERING), POUR VOUS PERMETTRE DE RAPPROCHER LA CUISINE DU LIEU OÙ SE TROUVE LE CLIENT, EN GARANTISSANT LA QUALITE MAXIMALE ET LA LIVRAISON DES PLATS AU-DESSUS DE 65 °C.

DEUTSCH

NEUE PRODUKTPALETTE VON WARMHALTESCHRÄNKEN FÜR BANKETTS UND CATERING, UM DIE KÜCHE DEM KUNDEN ANZUNÄHERN, UM IHM EINE MAXIMALE QUALITÄT UND EINE SPEISENLIEFERUNG VON ÜBER 65 °C ZU VERSICHERN.

**UNIFORMIDAD DE CIRCULACIÓN DEL AIRE CALIENTE / EVEN CIRCULATION OF HOT AIR / UNIFORMITÉ CIRCULATION AIR CHAUD / EINHEITLICHE HEISLUFTZIRKULATION**

Circulación uniforme y constante del aire gracias a un sistema único que imposibilita el contacto de las cubetas con el fondo o las paredes.

The circulation of air is even and constant thanks to a unique system that makes it impossible for the containers to touch the cabinet base or sides.

La circulation d'air chaud est uniforme et constant grâce à un système unique qui empêche que les bacs touchent le fond ou les parois.

Einheitliche und konstante Heissluftzirkulation dank eines einzigartigen Systems, welches den Kontakt der Behälter mit den Böden oder Wänden unmöglich macht.



1

**ASLAMIENTO EN LANA DE ROCA / ROCKWOOL INSULATION / ISOLATION EN LAINE DE ROCHE / ISOLIERUNG MIT STEINWOLLE**

**+ DURADERO**

Aislamiento térmico en lana de roca evitando la deformación con el calor y ampliando la vida útil del armario.

**+ AHORRO ENERGÉTICO**

Gracias al extraordinario sistema de aislamiento, se consigue el grado de temperatura deseado, con mayor rapidez y permite conservar el calor durante un periodo de tiempo más prolongado.

**+ HIGIÉNICO**

Con el sistema de guías monobloc (sin soldaduras) la limpieza interior es mayor, más fácil y rápida.

**+LONG LASTING**

Thermal insulation provided by rockwool preventing deformation through heat and lengthening the useful life of the cabinet.

**+ENERGY SAVING**

Thanks to the extraordinary thermal insulation system, the desired temperature is achieved more quickly and the heat is conserved for longer periods.

**+HYGIENE**

With the exclusive system of monoblock guides (without welds) cleanliness inside is grater, easier and faster.

**+DURABLE**

Isolation thermique en laine de roche pour éviter la déformation par la chaleur et augmenter la vie utile de l'armoire.

**+HYGIÉNIQUE**

Grâce au système exclusif de glissières monobloc (sans soudures) le nettoyage intérieur est plus parfait, plus aisé et plus rapide.

**+ÉCONOMIE D'ÉNERGIE**

Grâce à l'extraordinaire système d'isolation thermique, la température souhaitée s'obtient plus rapidement et cela permet de conserver la chaleur pendant une plus longue période de temps.

**+ LANGLEBIGKEIT**

Hitzeisolierung durch Steinwolle, welche eine Hitzedeformierung ausschliesst und die Gebrauchsdauer verlängert.

**+ ENERGIEERSPARNIS**

Dank des aussergewöhnlichen Isolierungsystems lässt sich die gewünschte Temperatur schnell erreichen und sie wird für einen längeren Zeitraum beibehalten.

**+ HYGIENE**

Mit dem Einschubführungssystem Monoblock (ohne Verschweissungen) ist die Reinigung des Inneren besser, einfacher und schneller.

2

**CAPACIDAD / CAPACITY / CAPACITÉ / KAPAZITÄT**

Guías monobloc (sin soldaduras) para rejillas acero inoxidable y cubetas Gastronorm 2/1 y 1/1. Para platos hasta diámetro 31 cm.  
 Monoblock guides (without welds) for St/Steel trays and Gastronorm containers 2/1 and 1/1. For dishes up to 31 cm diameter.  
 Glissières monobloc (sans soudures) pour grilles acier inoxydable et bacs Gastronorm 2/1 et 1/1. Pour des assiettes jusqu'à 31 cm diamètre.  
 Einschubführungen Monoblock (ohne Verschweissungen) für Roste aus rostfreiem Stahl und Gastronormbehälter 2/1 und 1/1. Für Teller bis zu einem Diameter 31 cm.

**FÁCIL MANEJO / EASY HANDLING / MANUPULATION AISÉE / EINFACHE HANDHABUNG**

Asas posteriores	Back side handles	Poignées postérieures	Griffe hinten
Ruedas pivotantes & 360°. Dos con freno	Rotating wheels 360°. Front wheels with brakes	Roues pivotantes 360°. Roues avant avec freins	Räder 360° drehbar. Zwei mit Bremsen.

3

**BLOQUE CALÓRICO / HEAT BLOCK / BLOC CHAUFFANT / HITZEBLOCK**

Extraíble sin necesidad de herramientas. Termostato regulador temperatura 0 °C a 100 °C. Recipiente humidificador integrado.	Extractable without the need of tools. Thermostat for regulation of temperature 0 °C to 100 °C. Provided with humidification container.	Amovible sans besoin d'outils. Thermostat régulateur de température 0 °C - 100 °C. Bac humidification intégré.	Auseinandernehmbar ohne den Bedarf von Werkzeugen. Regulierbares Thermostat von 0 °C a 100 °C. Integrierter Behälterluftbefeuchter.
--	---	--	---

**P810**

Ref. P81.000



Medidas Guías / Rails Dimensions / Dimensions Glissières / Einschubmasse	GN 2/1
Capacidad / Capacity / Capacité / Fassungsvermögen	10 GN 2/1 20 GN 1/1
Potencia / Potency / Puissance / Leistung	3000W
Tensión / Voltage / Voltage / Spannung	230 V II

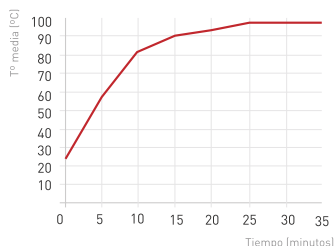

Ref. P81.010



Medidas Guías / Rails Dimensions / Dimensions Glissières / Einschubmasse	GN 2/1
Capacidad / Capacity / Capacité / Fassungsvermögen	20 GN 2/1 40 GN 1/1
Potencia / Potency / Puissance / Leistung	3000W
Tensión / Voltage / Voltage / Spannung	230 V II

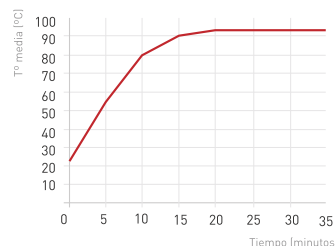



Ref. P81.020

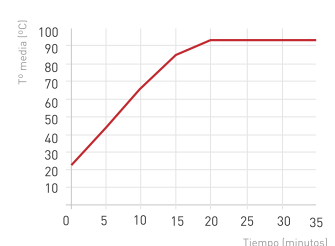

Medidas Guías / Rails Dimensions / Dimensions Glissières / Einschubmasse	GN 2/1
Capacidad / Capacity / Capacité / Fassungsvermögen	40 GN 2/1 80 GN 1/1
Potencia / Potency / Puissance / Leistung	4000W
Tensión / Voltage / Voltage / Spannung	230 V II



**P15026 / P15027 / P15028** Calentador de platos / Hot cupboards /  
 Chauffe - assiettes / Tellerwärmer

 +35 °C  
 +85 °C

REF	CAPACIDAD PLATOS / CAPACITY PLATES / CAPACITÉ ASSIETTES / TELLERKAPAZITÄT	V	W	U
P15.026	30	230	400	1
P15.027	60	230	750	1
P15.028	120	230	1250	1

Ref. P15.027



MEDIDAS INTERIORES / INNER SIZES /  
 MESURES INTERIEURES / INNENMASSE  
 41 x 38 x 66,5 cm

Ref. P15.026



MEDIDAS INTERIORES / INNER SIZES /  
 MESURES INTERIEURES / INNENMASSE  
 33,5 x 37,5 x 38,5 cm

Ref. 15028



Calentadores de platos Cater Chef. Acero inoxidable, doble pared, completamente aislado térmicamente. Con termostato e interruptor con piloto de control. Estantes interiores regulables y extraíbles. Puertas con bisagras muy reforzadas. Diámetro máximo de los platos de 32 cm.

Hot cupboards. St/Steel, wholly insulated. With thermostat and switch with indicator light, removable and adjustable shelves. Door with heavy duty hinges. Diameter max. plates 32 cm.

Chauffe-assiettes. Inox, double paroi, entièrement calorifugée, avec thermostat et interrupteur avec voyant de contrôle, étagères ajustables et amovibles. Porte avec charnières très résistantes. Diamètre max. assiettes 32 cm.

Tellerwärmer Cater Chef aus rostfreiem Stahl, Doppelwändig, komplett wärmeisoliert. Mit Thermostat und Schalter mit Kontrollleuchten. Innere Einlegeböden regulierbar und herausnehmbar. Türen mit verstärkten Scharnieren. Max. Tellerdiameter 32 cm.

MEDIDAS INTERIORES / INNER SIZES /  
 MESURES INTERIEURES / INNENMASSE  
 70 x 35 x 80 cm

LÁMPARAS CALENTADORAS / HEAT SHADE / LAMPE CHAUFFANTE / WÄRMELAMPEN

**P5080**

Lámpara mantenimiento comida caliente con soporte mesa / Heat shade with table support / Lampe chauffante avec support / Wärmelampe mit Tischständer



REF	cm	V	W	U
P508.015	22 x 22 x 65	230	250	1

Lámpara adaptada para mantener caliente todos platos. Estructura compuesta de lámpara infrarojos con base en acero inoxidable. Bombilla roja (250 W) incluida en el precio.

Lampe adaptée pour maintenir au chaud tous vos plats. Structure composée par lampe infrarouge ave base en inoxydable. Livrée avec ampoule rouge (250 W).

Appliance adapted to heat and keep warm snacks and ready meals. Structure is composed by an infrared lamp with a stainless steel base. Delivered with red bulb (250 W).

Lampe geeignet zum Warmhalten von allen Speisen. Struktur zusammgebaut aus Infrarotbirne mit Gehäuse aus rostfreien Stahl. Rote Birne (250 W) im Preis inklusive.

**P6880**

Lámpara mantenedora de comida caliente / Heat shade / Abat - jour pour lampe chauffante / Wärmelampe



REF	Ø cm	V	U
P688.045	23	230	1

Aluminio. Con interruptor. Se entrega sin lámpara. Cable extensible hasta 180 cm.

Aluminium avec interrupteur. Livraison sans ampoule. Avec cable extensible jusqu'à 180 cm.

Aluminium with on/off switch. Delivered without bulb. Cable with rise and fall mechanism upto 180 cm.

Aluminium. Mit Schalter. Lieferung ohne Birne. Auseinanderziehbares Kabel bis 180 cm.

**P15031 / P15032** Lámpara mantenedora de comida caliente / Heat shade with lamp / Abat - jour pour lampe chauffante infra - rouge / Wärmelampe

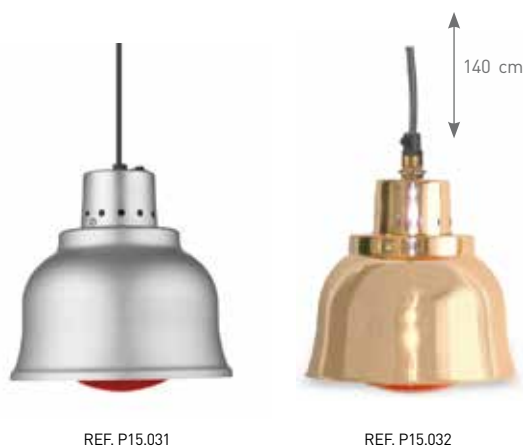

REF	Ø cm	V	U
P15.031	23	230	1
P15.032	23	230	1

Cable fijo	Se entrega con lámpara roja	CE
Fixed cable	Delivered with red bulb	
Cable fixe	Livraison avec ampoule rouge	
Festes Kabel	Lieferung mit roter Lampe	

Aluminio o cobre. Con interruptor. Se pone en funcionamiento rápidamente y proporciona un calor penetrante sin solidificar la superficie de las salsas. Fácil de instalar. Se entrega con lámpara (250 W max). Versión con cable fijo.

Aluminium ou cuivre. Avec interrupteur. Mise en service rapide. Chaleur pénétrante sans coaguler la surface des sauces, etc. Facile à installer. Livraison avec ampoule (250 W max). Avec cable fixe.

Aluminium or copper. With on/off switch. It gives instant direct heat. Provides a penetrating heat without congealing surfaces, gravies, etc. Simple to install. Delivered with bulb (250 W max). Cable fixe.

Aluminium oder Kupfer. Mit Schalter. Schnelles Einschalten und verteilt eine durchdringende Wärme ohne die Oberfläche der Sossen zu verbrennen. Einfache Installierung. Lieferung mit Birne (250 W max). Mit festen Kabel.



**P15029 / P15030** Lámpara mantenedora de comida caliente / Heat shade with lamp /  
Abat - jour pour lampe chauffante infra-rouge / Wärmelampe

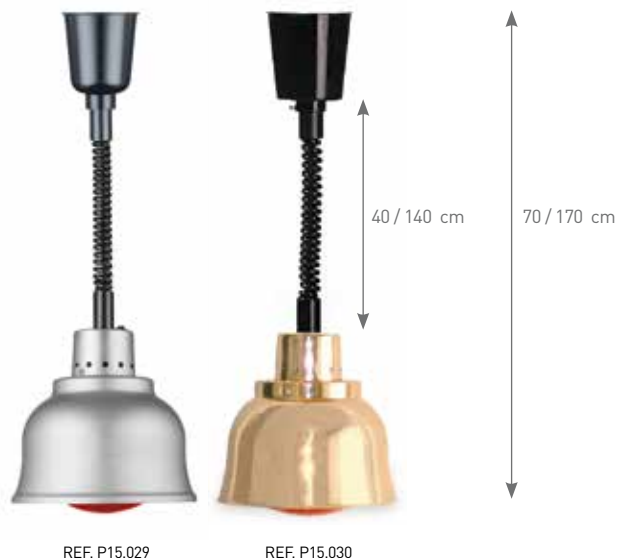

REF	Ø cm	V	U
P15.029	23	230	1
P15.030	23	230	1

Cable extensible / Rise&fall cable / Cable extensible / Festes Kabel  
Se entrega con lámpara roja / Delivered with red bulb / Livraison avec ampoule rouge / Lieferung mit roter Lampe



Aluminio o cobre. Con interruptor. Se pone en funcionamiento rápidamente y proporciona un calor penetrante sin solidificar la superficie de las salsas. Fácil de instalar. Se entrega con lámpara (250 W max). Versión con cable de mecanismo extensible (máx. 140 cm).

Aluminium ou cuivre. Avec interrupteur. Mise en service rapide. Chaleur pénétrante sans coaguler la surface des sauces, etc. Facile à installer. Livraison avec ampoule (250 W max). Avec cable extensible (max. 140 cm).

Aluminium or copper. With on/off switch. It gives instant direct heat. Provides a penetrating heat without congealing surfaces, gravies, etc. Simple to install. Delivered with bulb (250 W max). Cable with rise and fall mechanism (max. 140 cm).

Aluminium oder Kupfer. Mit Schalter. Schnelles Einschalten und verteilt eine durchdringende Wärme ohne die Oberfläche der Sossen zu verbrennen. Einfache Installation. Lieferung mit Birne (250 W max). Mit ausziehbarem Kabel (máx. 140 cm).

**P15033 / P15034** Recambio lámparas / Bulb only / Ampoule seule / Ersatzbirnen



REF	COLOR / COLOUR / COULEUR / FARBE	W	U
P15.033	rojo / red / rouge / Rot	175	1
P15.034	blanco / white / blanc / Weiss	175	1
P710.205	rojo / red / rouge / Rot	250	1
P710.206	blanco / white / blanc / Weiss	250	1



**P962** Calentador de platos o bandejas / Hot tray warmer / Réchaud / Tablett - oder Tellerwarmlhalter



REF	QUEMADORES / BURNERS / BRÛLEURS / BRENNER	mm	U
P962.002	2	370 x 175 x 70	1
P962.003	3	430 x 175 x 70	1

Inox con placa base de aluminio. / St/Steel with aluminium cover plate. / Inox avec plaque couvercle en aluminium. / Rostfreier Stahl mit Aluminium Basisplatte.

2 ó 3 quemadores. / 2 or 3 burners. / 2 ou 3 brûleurs. / 2 oder 3 Brenner.

**P15073 / P15074** Placa caliente / Heating plate / Plaque chauffante / Heizplatte



REF	mm	V	W	U
P15.073	600 x 400	230	600	1
P15.074	530 x 325	230	600	1

(gastronorm 1/1)

Fabricada en acero inoxidable 18/10. / Termostato regulable hasta 75 °C. / Con interruptor central y piloto de control.



18/10 St/Steel. Adjutable thermostat up to 75 °C. / With on / off switch and indicator light.

Habillage en inox 18/10. Thermostat réglable jusqu'à 75 °C. / Interrupteur central et voyant de contrôle.

Hergestellt aus Edelstahl 18/10. / Thermostat regulierbar bis 75 °C. / Mit zentralem Schalter und Kontrollleuchten.



**CATERING E INSTITUCIÓN /**  
CATERING AND INSTITUTION /  
CATERING ET COLLECTIVITÉS /  
CATERING UND INSTITUTION

<b>5.1</b>	MELAMINA / MELAMINE / MÉLAMINE / MELAMIN	294
<b>5.2</b>	COLECTIVIDADES / INSTITUTIONS / COLLECTIVITÉS / KOLLEKTIVITÄT	318
<b>5.3</b>	ALFOMBRAS CAUCHO / NATURAL RUBBER MATS / TAPIS EN CAOUTCHOUC / KAUTSCHUKMATTEN	323
<b>5.4</b>	SEÑALIZACIÓN / SIGNS / SIGNALISATION / MARKIERUNG	324

**TODOS ESTOS  
PRODUCTOS AHORA  
SON VOLLRATH /**

**ALL THESE PRODUCTS  
ARE NOW VOLLRATH /**

**TOUS CES PRODUIT  
SONT ACTUELLEMENT  
VOLLRATH /**

**ALLE DIESE PRODUKTE  
SIND JETZT VOLLRATH**

**CUBIC®**



.....  
 Descubre la mejor presentación de buffet /  
 Discover the best buffet display /  
 Découvrez la meilleure présentation buffet /  
 Entdecken sie die beste buffet-präsentation

**P. 32**



.....  
 Baño maría /  
 Bain marie /  
 Bain-marie /  
 Wasserbad

**P. 74**



.....  
 Baño maría /  
 Bain marie /  
 Bain-marie /  
 Wasserbad

**P. 76**



.....  
 Chafing dishes

**P. 87**



.....  
 Bambú natural & madera /  
 Natural bamboo & wood /  
 Bambou naturel & bois /  
 Naturbambus & holz

**P. 122**



.....  
 Bambú polipropileno /  
 Polypropylene bamboo /  
 Bambou polypropylène /  
 Bambus polypropylen

**P. 124**



.....  
 Cesta /  
 Basket /  
 Corbeille /  
 Korb

**P. 126**





.....  
 Cubiteras / Wine buckets /  
 Seaux à champagne /Champagnerkühler

P. 156-159



.....  
 Tetera /  
 Tea pot /  
 Thière /  
 Teekanne

P. 173

**Cosmos  
 Planet  
 Atlantis**



.....  
 Bar

P. 171-172



.....  
 Manteles /  
 Place mats /  
 Sets de table /  
 Platzmatten

P. 134



.....  
 Jarra /  
 Server /  
 Pichet /  
 Karaffe

P. 177-178



.....  
 Pizarras /  
 Slates /  
 Ardoises /  
 Schieferplatten

P. 142



Aluminio fundición / Cast aluminium /  
 Fonte d'aluminium / Aluminiumguss

Hierro fundido / Cast iron /  
 Fonté émaillée / Gusseisen

18/10  
 Inoxidable / St/Steel /  
 Inoxydable / Edelstahl

.....  
 Miniaturas / Miniatures /  
 Miniatures /Miniaturen

P. 136



.....  
 Complementos servicio de mesa/ Table top service complements /  
 Accessoires service de table / Tischservice zubehör

P. 145



.....  
 Servilletero /  
 Napkin holder /  
 Porte-serviettes /  
 Serviettenspender

P. 149



.....  
 Portamenús /  
 Menu holder /  
 Porte-Menus /  
 Menümappe

P. 150

## MELAMINA / MELAMINE / MÉLAMINE / MELAMIN

# MELAMINA Y PRESENTACIÓN / MELAMINE & PRESENTATION / MÉLAMINE ET PRÉSENTATION / MELAMIN UND PRÄSENTATION



ESPAÑOL

LA MELAMINA ES UNA RESINA SINTÉTICA QUE SE ENDURECE Y TOMA FORMA DESPUÉS DE UN PROCESO DE CALENTAMIENTO. ES UN MATERIAL MUY UTILIZADO EN EL SERVICIO DE MESA Y PRESENTACIÓN POR SUS PROPIEDADES.

ENGLISH

MELAMINE IS A SYNTHETIC RESIN WHICH BECOMES HARDEN AND FORMED AFTER HEATING. IT IS HIGHLY RECOMMENDED FOR TABLE & BUFFET SERVICE FOR ITS PROPERTIES.

FRANÇAIS

LA MÉLAMINE EST UNE RÉSINE SYNTHÉTIQUE QUI SE DURCIT ET PREND-FORME APRÈS UN PROCESSUS SPÉCIAL DE CHAUFFEMENT. TRÈS UTILISÉE DANS LE SERVICE DE TABLE ET BUFFET PAR SES PROPERTIES.

DEUTSCH

MELAMIN IST EIN KUNSTHARZ, WELCHES SICH VERHÄRTET UND NACH EINEM ERHITZUNGSPROZESS EINE FORM ANNIMMT. AUFGRUND SEINER EIGENSCHAFTEN IST ES EIN VIELBENUTZTES MATERIAL FÜR DEN TISCHSERVICE UND DIE PRÄSENTATION.

## CARACTERÍSTICAS / MAIN FEATURES / PRINCIPALES CARACTÉRISTIQUES / PRODUKTMERKMALE

CONTACTO CON ALIMENTOS: CERTIFICADO POR SGS  
CONDICIONES DE TRABAJO: ENTRE -20°C Y +70°C

FOOD CONTACT APPROVED: CERTIFIED BY SGS  
WITHSTANDS TEMPERATURES: -20°C & +70°C

CONTACT AVEC ALIMENTS: CERTIFIÉ PAR SGS  
TEMPÉRATURES ENTRE: -20°C ET +70°C

KONTAKT MIT LEBENSMITTELN:  
ZERTIFIZIERT DURCH SGS  
ARBEITSTEMPERATUREN: ZWISCHEN -20°C  
UND +70°C

## PROPIEDADES / PROPERTIES / PROPRIÉTÉS / EIGENSCHAFTEN

RESISTENTE AL CALOR  
RESISTENTE A LA CORROSIÓN  
NO TÓXICO

INODORO  
LIGERO E INDEFORMABLE  
POCO CONDUCTOR DEL CALOR

HEAT RESISTANT  
CORROSION RESISTANT  
NON-TOXIC  
NON-ODOROUS  
LIGHT WEIGHT AND FREE FORM DEFORMATION  
LOW HEAT CONDUCTIVITY

RÉSISTANTE À LA CHALEUR  
RÉSISTANTE À LA CORROSION  
NON-TOXIQUE  
INODORE  
LÉGÈRE ET INDEFORMABLE  
BAISSE CONDUCTIVITÉ DE LA CHALEUR

HITZBESTÄNDIG, RESISTENT GEGEN  
KORROSION, NICHT GIFTIG, GERUCHLOS,  
LEICHT UND UNVERFORMBAR,  
GERINGE WÄRMELEITUNG

## USOS / USES / USAGES / GEBRAUCH

NO RECOMENDADA / NOT RECOMMENDED /  
NON RECOMMANDÉE / NICHT EMPFHOLEN

MICROONDAS  
HORNO  
DIRECTO AL FUEGO  
ACEITE Y PRODUCTOS QUÍMICOS

MICROWAVE  
OVEN  
DIRECT FLAME  
OIL AND CHEMICAL PRODUCTS

MICRO-ONDES  
FOUR  
DIRECT AU FEU  
HUILE OU PRODUITS CHIMIQUES

MIKROWELLEN  
ÖFEN  
DIREKTE FLAMME  
ÖL UND CHEMISCHE PRODUKTE



**P2265** Pala horno roble / Oven oak peel / Pelle four chêne / Backofenschaufel Eiche

REF	mm	U
P22.650	Ø 300	6
P22.651	530 x 200	6
P22.652	610 x 200	6



**P2260** Soporte presentación roble / Oak display plate / Présentoir chêne / Präsentationsständer Eiche

REF	MOD.	mm	U
P22.600	1/1	530 x 325	3
P22.601	1/2	325 x 265	6
P22.602	1/3	325 x 176	6
P22.603	1/4	265 x 162	6
P22.604	2/4	530 x 165	6
P22.605		500 x 250	3
P22.606		250 x 150	6



Con pies antideslizantes  
With non-slip feet  
Avec pieds antidérapants  
Mit Antirutschfüßen

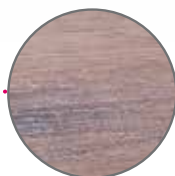

## MELAMINA / MELAMINE / MÉLAMINE / MELAMIN

**P2262** Bandeja presentación roble / Oak serving tray / Plateau présentation bois / Eichentablett

REF	mm	H mm	U
P22.620	300 x 150	18	12
P22.621	300 x 200	18	12
P22.622	400 x 300	18	6

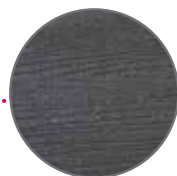
**P2261** Soporte presentación / Display plate / Présentoir / Präsentationsplatte

REF	MOD.	mm	BLANCO / WHITE / BLANC / WEISS	NEGRO / BLACK / NOIR / SCHWARZ	U
P22.610	1/1	530 x 325	B	N	3
P22.611	1/2	325 x 265	B	N	4
P22.612	1/3	325 x 176	B	N	6
P22.613	1/4	265 x 162	B	N	6
P22.614	2/4	530 x 165	B	N	6
P22.615		500 x 250	B	N	3
P22.616		250 x 150	B	N	6

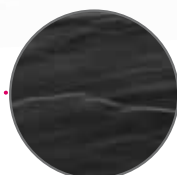

Con pies antideslizantes REF + código color  
With non-slip feet REF + color code  
Avec pieds antidérapants REF + code couleur  
Mit Antirutschfüßen REF + Farbcode

**P2264** Bandeja base pizarra / Slate display plate / Présentoir base ardoise / Präsentationstablett Schiefertafel

REF	MOD.	mm	BLANCO / WHITE / BLANC / WEISS	NEGRO / BLACK / NOIR / SCHWARZ	U
P22.640	1/2	325 x 265	B	N	6
P22.641	1/3	325 x 175	B	N	6
P22.642	1/4	265 x 160	B	N	6



Con pies antideslizantes REF + código color  
With non-slip feet REF + color code  
Avec pieds antidérapants REF + code couleur  
Mit Antirutschfüßen REF + Farbcode



**P22161** Soporte presentación Pizarra - granito / Slate - granite Display plate /  
 Présentoir Ardoise - granite / Präsentationsplatte Schiefer - Granit

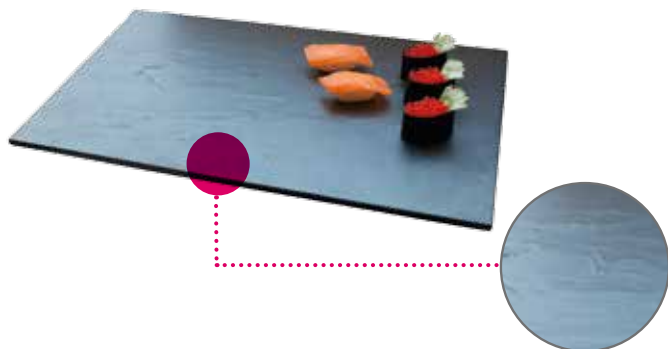

REF	MOD.	mm	H mm	U
P22.161	1/1	530 x 325	7,0	3
P22.162	1/2	325 x 265	7,0	3

Reversible: 1 cara pizarra - 1 cara granito  
 Reversible: 1 slate side - 1 granite side  
 Réversible: 1 face ardoise - 1 face granite  
 Reversibel: 1 Seite Schiefer - 1 Seite Granit

**P2267** Pala horno pizarra / Slate oven peel / Pelle four ardoise / Ofenschieber, Schiefer

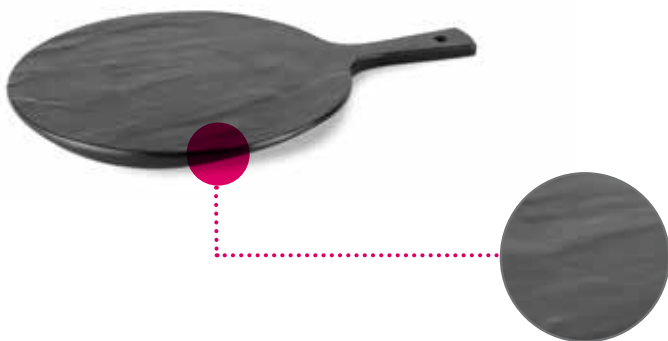

REF	Ø mm	L mm	H mm	U
P22.670	230	320	15	1
P22.671	300	430	15	1
P22.672	380	530	15	1

**P22144 / P22145** Soporte presentación doble cara pizarra - bambú / Double face slate - bamboo display plate /  
 Présentoir double face bambou - ardoise / Zweiseitige Präsentationsplatte Schiefer - Bambus



REF	Ø mm	H mm	U
P22.144	330	10	3
P22.145	430	10	3

**P22017 / P22018** Soporte "mármol" / "Marble" display plate / Plateau "Marbre" / "Marmor" Platte

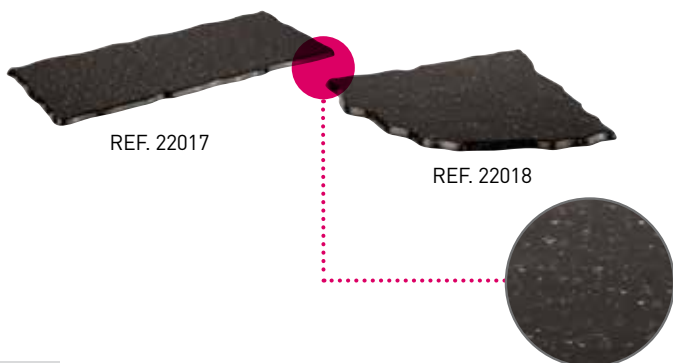

REF	mm	H mm	U
P22.017	590 x 240	24	3
P22.018	360	20	6



**MINIATURAS MELAMINA  
AHORA SON VOLLRATH**

**MELAMINE MINIATURES ARE NOW  
VOLLRATH**

**MÉLAMINE EST MAINTENANT  
VOLLRATH**

**MELAMIN IST JETZT  
VOLLRATH**

VER PRODUCTOS EN / SEE PRODUCTS ON / VOIR PRODUITS EN / SIEHE PRODUKTE IN **P. 138**

### GN 1/1

530 x 325 mm

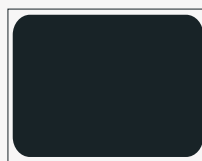

REF	H mm	U
P22.052	20	6
P22.054	40	3
P22.006	65	2

### GN 1/1 DOUBLE

530 x 325 mm



REF	H mm	U
P22.089	65	2

### GN 2/3

353 x 325 mm



REF	H mm	U
P22.048	65	3

### GN 1/2

325 x 265 mm

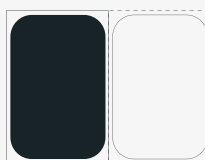

REF	H mm	U
P22.040	20	6
P22.042	40	3
P22.007	65	3
P22.083	100	3

### GN 2/4

530 x 162 mm

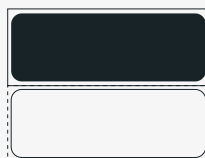

REF	H mm	U
P22.087	20	6
P22.050	65	3

### GN 1/3

325 x 175 mm

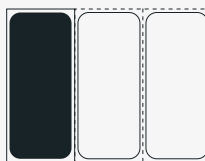

REF	H mm	U
P22.008	65	3
P22.079	100	3

### GN 1/4

265 x 162 mm



REF	H mm	U
P22.044	65	3

### GN 1/6

176 x 162 mm

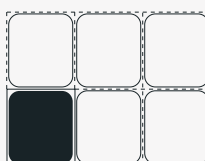

REF	H mm	U
P22.046	65	6
P22.081	100	6

## MELAMINA / MELAMINE / MÉLAMINE / MELAMIN

**GN 1/1**

530 x 325 mm

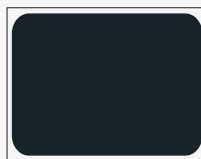

REF	H mm	U
P22.051	20	6
P22.053	40	3
P22.009	65	2

**GN 2/3**

353 x 325 mm



REF	H mm	U
P22.047	65	3

**GN 1/2**

325 x 265 mm

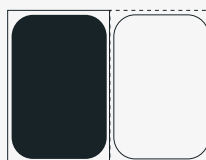

REF	H mm	U
P22.039	20	6
P22.041	40	3
P22.010	65	3
P22.084	100	3

**GN 2/4**

530 x 162 mm

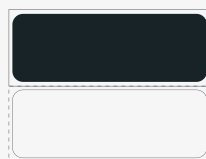

REF	H mm	U
P22.049	65	3

**GN 1/3**

325 x 175 mm

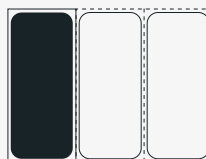

REF	H mm	U
P22.011	65	3
P22.080	100	3

**GN 1/4**

265 x 162 mm

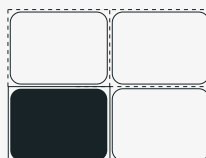

REF	H mm	U
P22.043	65	3

**GN 1/6**

176 x 162 mm

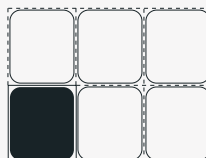

REF	H mm	U
P22.045	65	6
P22.082	100	6



## GN 1/1

530 x 325 mm



Rojo / Red / Rouge / Rot

REF	H mm	U
P22.055	20	6
P22.056	40	3
P22.057	65	2

Amarillo / Yellow / Jaune / Gelb

REF	H mm	U
P22.058	20	6
P22.059	40	3
P22.060	65	2

Verde / Green / Vert / Grün

REF	H mm	U
P22.061	20	6
P22.062	40	3
P22.063	65	2

Azul / Blue / Bleu / Blau

REF	H mm	U
P22.064	20	6
P22.065	40	3
P22.066	65	2

## GN 1/2

325 x 265 mm



Rojo / Red / Rouge / Rot

REF	H mm	U
P22.067	20	6
P22.068	40	3
P22.069	65	3

Amarillo / Yellow / Jaune / Gelb

REF	H mm	U
P22.070	20	6
P22.071	40	3
P22.072	65	3

Verde / Green / Vert / Grün

REF	H mm	U
P22.073	20	6
P22.074	40	3
P22.075	65	3

Azul / Blue / Bleu / Blau

REF	H mm	U
P22.076	20	6
P22.077	40	3
P22.078	65	3

## P22152

Cubeta GN curvada / Curved GN pan / GN courbé / Kurviger GN Behälter



REF	mm	H mm	U
P22.152	535 x 265 (GN 1/1)	65	2
P22.153	330 x 265 (GN 1/2)	65	3

## P22159

Stand GN curvado / GN curved system stand / Présentoir GN courbé / Kurviger GN Ständer

REF	mm	H mm	U
P22.159	580 x 525	325	6



El precio no incluye cubetas / Price does not include containers / Les bacs ne sont pas inclus dans le PRIX / Behälter nicht im Preis inklusive

**P22154**

Expositor buffet para cubetas GN 1/1 /  
1/1 Gastronorm buffet displayer /  
Présentoir buffet pour bacs GN 1/1 /  
Buffetständer für GN 1/1 Behälter



REF	TIPO/TYPE	mm	H mm	U
P22.154	1/1	565 x 525	325	6

Cubetas no incluidas /  
Containers not included /  
Bacs non inclus /  
Behälter nicht inklusive

**P22155**

Expositor buffet para cubetas GN 1/2 /  
1/2 Gastronorm buffet displayer /  
Présentoir buffet pour bacs GN 1/2 /  
Buffetständer für GN 1/2 Behälter



REF	TIPO/TYPE	mm	H mm	U
P22.155	1/2	360 x 525	325	6

Cubetas no incluidas /  
Containers not included /  
Bacs non inclus /  
Behälter nicht inklusive

**P22156**

Expositor buffet para cubetas GN 1/3 /  
1/3 Gastronorm buffet displayer /  
Présentoir buffet pour bacs GN 1/3 /  
Buffetständer für GN 1/3 Behälter



REF	TIPO/TYPE	mm	H mm	U
P22.156	1/3	360 x 525	325	6

Cubetas no incluidas /  
Containers not included /  
Bacs non inclus /  
Behälter nicht inklusive

**P22157**

Expositor buffet para cubetas GN 1/6 /  
1/6 Gastronorm buffet displayer /  
Présentoir buffet pour bacs GN 1/6 /  
Buffetständer für GN 1/6 Behälter



REF	TIPO/TYPE	mm	H mm	U
P22.157	1/6	215 x 525	325	6

Cubetas no incluidas /  
Containers not included /  
Bacs non inclus /  
Behälter nicht inklusive

## P22123

Expositor 3 pisos con 3 bandejas /  
3 Tier squared stand with 3 plates /  
Présentoir 3 niveaux avec 3 Plateaux /  
Buffetstände 3 Ebenen mit 3 Platten



REF	L mm	U
P22.123	770 x 460 x 830	1

## P22158

Expositor 4 vasijas /  
4 Crocks system stand /  
Présentoir 4 cruches /  
Buffetstände 4 Gefässe



REF	mm	H mm	U
P22.158	190 x 525	325	6

Vasijas no incluídas. Ver 22160 pg 309 /  
Crocks not included. View 22160 pg 309 /  
Cruches pas incluses. Voir 22160 pg 309 /  
Gefässe nicht inklusive. Siehe 22160 Seite 309

## P2222

Expositor bambú con 3 bols /  
Bamboo displayer with 3 bowls /  
Présentoir bambou avec 3 bols /  
Buffetstände Bambus mit 3 Schalen



REF	mm	H mm	Lts	U
P22.220	290 x 110	35	0,20	6
P22.221	400 x 130	60	0,50	6
P22.222	495 x 160	85	1,10	6

## MELAMINA / MELAMINE / MÉLAMINE / MELAMIN

**P2290** Plato / Dish / Assiette / Platte

REF	Ø mm	H mm	U
P22.901	195	28	12
P22.902	280	29	12

**P2297** Bol para noodels / Noodles bowl /  
Bol pour nouilles / Nudelschüssel

REF	Ø mm	H mm	U
P22.971	173	76	12
P22.972	250	87	6

**P2291** Bol / Bowl / Bol / Schüssel

REF	Ø mm	H mm	U
P22.911	101	40	12
P22.912	115	58	12

**P2296** Bol para salsas / Sauce bowl /  
Bol pour sauces / Schüssel für Sossen

REF	Ø mm	H mm	U
P22.960	115	55	20



**P2295** Plato para bol / Dish for bowl /  
Assiette pour bol / Unterteller für Schüssel



REF	mm	H mm	U
P22.950	159 x 127	23	12

**P2294** Bandeja rectangular / Rectangular Tray /  
Plateau rectangulaire / Rechteckiges Tablett



REF	mm	H mm	U
P22.940	234 x 147	25	12

**P2292** Bandeja snacks o salsas /  
Snacks or sauce tray /  
Plateaux sauces /  
Schale für Snacks oder Sossen



REF	mm	H mm	U
P22.920	190 x 80	30	12

**P2293** Bandeja snacks o salsas / Snacks or sauce tray /  
Plateaux sauces / Schale für Snacks oder Sossen



REF	mm	H mm	U
P22.930	92 x 69	31	24

## MELAMINA / MELAMINE / MÉLAMINE / MELAMIN

Bandeja presentación oval pequeña /  
Small oval plate /  
Plateau présentation ovale petit /  
Kleines ovales Buffettablett

**P22270**

REF	mm	H mm	U
P22.270	250 x 120	25	12

Bandeja presentación cuadrada /  
Square plate /  
Plateau présentation carré /  
Quadratisches Buffettablett

**P22271**

REF	mm	H mm	U
P22.271	365 x 365	44	3

Bandeja presentación oval grande /  
Large oval plate /  
Plateau présentation ovale grand /  
Grosses ovales Buffettablett

**P22272**

REF	mm	H mm	U
P22.272	530 x 265	45	6

Bol ovalado pequeño /  
Small oval bowl /  
Bol ovale petit /  
Kleine ovale Buffetschüssel

**P22273**

REF	mm	H mm	U
P22.273	250 x 120	75	3

Bol cuadrado /  
Square bowl /  
Bol carré /  
Quadratische Schüssel

**P22274**

REF	mm	H mm	U
P22.274	355 x 355	123	3

Bol ovalado grande /  
Large oval bowl /  
Bol ovale grand /  
Grosse ovale Schüssel

**P22275**

REF	mm	H mm	U
P22.275	530 x 270	107	2

**P22037** Fuente rectangular alta /  
High oblong plate /  
Plateau rectangulaire haut /  
Hohe rechteckige Schale



REF	mm	H mm	U
P22.037	500 x 200	50	3

**P22038** Fuente rectangular alta /  
High oblong plate /  
Plateau rectangulaire haut /  
Hohe rechteckige Schale



REF	mm	H mm	U
P22.038	350 x 250	50	3

**P2200** Fuente cuadrada / Squared tray /  
Plateau carré / Quadratische Schale



REF	A mm	H mm	U
P22.001	335	55	3
P22.000	373	28	3

**P2201** Fuente rectangular / Oblong plate /  
Plateau rectangulaire / Quadratische Schale

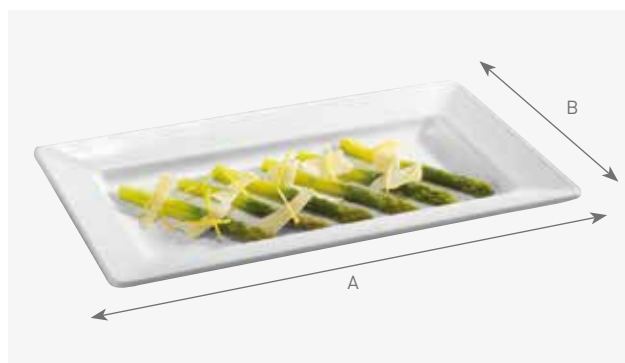

REF	A x B mm	H mm	U
P22.012	358 x 205	38	3
P22.013	443 x 221	44	3
P22.014	495 x 272	56	3
P22.015	557 x 322	52	3
P22.016	710 x 405	53	3

**P2209** Fuente rectangular honda / Classic deep dish /  
Ravier carré / Tiefe quadratische Schale



REF	mm	H mm	U
P22.091	250 x 150	65	6
P22.092	305 x 220	25	6

**P22164** Fuente rectangular / Oblong serving dish /  
Ravier / Quadratische Schale



REF	mm	H mm	U
P22.164	250 x 150	70	3
P22.165	350 x 250	70	3
P22.166	450 x 300	70	2





**P22090** Plato redondo de presentación /  
Round plate presentation /  
Plateau rond présentation /  
Runder Servierteller



REF	Ø mm	H mm	U
P22.090	310	20	4

**P2215** Bandeja gastronorm /  
Gastronorm tray /  
Plateau gastronorme /  
Gastronormplatte



REF	mm	H mm	U
P22.150	530 x 325	20	3
P22.151	325 x 265	20	6

**P22002** Bandeja exhibición cuadrada /  
Squared display plate /  
Plateau carré présentation /  
Quadratische Präsentationsplatte



REF	mm	H mm	U
P22.0021	305	35	3
P22.002	355	40	3
P22.0023	405	45	3

**P22003** Bandeja exhibición cuadrada /  
Squared display plate /  
Plateau carré présentation /  
Quadratische Präsentationsplatte



REF	mm	H mm	U
P22.0031	310	40	3
P22.003	350	40	3
P22.0033	420	50	3

**P2208** Bandeja exhibición rectangular / Oblong display tray /  
Plateau rectangulaire / Quadratische Präsentationsplatte



REF	mm	H mm	U
P22.085	390 x 150	15	6
P22.086	500 x 180	18	6

## MELAMINA / MELAMINE / MÉLAMINE / MELAMIN

**P22500** Fuente oval / Oval serving dish / Plat ovale / Ovale Buffetschale

REF	mm	H mm	U
P22.500	265 x 162	40	1
P22.501	325 x 200	40	1
P22.502	435 x 265	40	1

**P22170** Bandeja forma hoja / Leaf plate / Plateau forme feuille / Schale Blattform

REF	mm	H mm	U
P22.170	505 x 240	70	3

**P22163** Fuente oval / Oval serving dish / Plat ovale / Ovale Buffetschale

REF	mm	H mm	U
P22.163	715 x 285	40	3

**P22103** Bandeja 5 compartimentos / 5 - Compartment bowl / Bol 5 compartiments / Schale 5 Unterteilungen

REF	Ø mm	H mm	U
P22.103	380	65	3

**IDEA!**

Espacio central ideal para salsas y dippear.  
 Central space ideal for sauces and dips.  
 Espace central idéal pour sauces et tartiner.  
 Das perfekte Mittelstück für Sossen und Dips.

**P22177** Bandeja redonda / Round plate /  
Plateau rond / Runder Servierteller



REF	Ø mm	H mm	U
P22.177	350	35	3

**P22023** Fuente oval honda / Oval plate /  
Plateau ovale / Ovale tiefe Buffetschale



REF	mm	H mm	U
P22.023	500 x 360	67	3

**P22022** Fuente redonda / Round bowl /  
Bol rond / Runde Buffetschüssel



REF	Ø mm	H mm	U
P22.022	360	70	3

**P22019** Bol redondo / Round bowl /  
Bol rond / Runde Schüssel



REF	Ø mm	H mm	U
P22.019	200	90	3
P22.020	280	125	3
P22.021	380	170	3

**P2210** Bol redondo / Round bowl /  
Bol rond / Runde Schüssel



REF	Ø mm	H mm	U
P22.100	160	90	6
P22.101	260	100	6
P22.102	360	130	3

**P22004** Bol cuadrado / Deep squared bowl /  
Bol carré / Quadratische Schüssel



REF	mm	H mm	U
P22.004	250 x 250	88	3
P22.005	375 x 375	90	3

## MELAMINA / MELAMINE / MÉLAMINE / MELAMIN

**P222**

Bol cuadrado hondo /  
Deep squared bowl /  
Bol carré /  
Tiefe quadratische Schüssel



REF	mm	H mm	U
P22.211	70 x 70	42	24
P22.200	90 x 90	55	12
P22.201	130 x 130	70	6
P22.202*	180 x 180	85	6
P22.203	240 x 240	100	3
P22.204	300 x 300	115	3

**P2220**

Bol cuadrado hondo dos colores /  
Two tones deep squared bowl /  
Bol carré deux couleurs /  
Zweifarbige tiefe quadratische  
Schüssel

REF	mm	H mm	ROJO / RED / ROUGE / ROT	AZUL / BLUE / BLEU / BLAU	AMARILLO / YELLOW / JAUNE / GELB	VERDE / GREEN / VERT / GRÜN	NEGRO / BLACK / NOIR / SCHWARZ	U
P22.200	90 x 90	55	R	A	AM	V	N	12
P22.202	180 x 180*	85	R	A	AM	V	N	6
P22.203	240 x 240	100	R	A	AM	V	N	3



\*Encaja en expositores CUBIC.  
Fits in CUBIC display.  
Adaptable aux présentoirs CUBIC.  
Anpassbar an dem CUBIC Buffetaussteller

Ver/See/Voir/ Siehe seite/  
Vollrath catalogue P. 51

REF + Código color  
REF + Color code  
REF + Code couleur  
REF + Farbcode

**P2216**

Bol cónico /  
Conical bowl /  
Bol conique /  
Konische Schüssel



REF	Ø mm	H mm	U
P22.167	130	85	6
P22.168	160	108	6

**P2217**

Bol torneado /  
Spin round bowl /  
Bol tourné /  
Gedrehte Schüssel



REF	Ø mm	H mm	U
P22.171	205	95	3
P22.172	245	105	3
P22.173	280	120	3



**P22169** Bol oval / Oval bowl /  
Bol ovale / Ovale Schüssel



REF	mm	H mm	U
P22.169	290 x 165	150	6

**P22174** Bol redondo inclinado / Slanted round bowl /  
Bol rond incliné / Schräge runde Schale



REF	mm	H mm	Lts	U
P22.174	212 x 208	104	0,60	6
P22.175	300 x 291	137	1,60	3
P22.176	360 x 349	163	2,85	3

**P22108** Platillo cuadrado / Squared bowl /  
Bol carré / Quadratisches Tellerchen



REF	mm	H mm	Lts	U
P22.108	100 x 100	33	0,10	24
P22.109	125 x 125	35	0,18	24

**P22099** Plato - bol / Bowl - plate /  
Plat - bol / Teller - Schüssel



REF	Ø mm	H mm	U
P22.099	380	90	6

## MELAMINA / MELAMINE / MÉLAMINE / MELAMIN

**P2225** Bol cereales encastrable / Stackable bowl /  
Bol empilable / Stapelbare Müslischüssel

REF	Ø mm	H mm	U
P22.250	120	45	12
P22.251	140	55	12

**P22088** Platillo para huevo / Egg cup /  
Coquetier / Eierbecher

REF	mm	H mm	U
P22.088	115 x 115	20	24

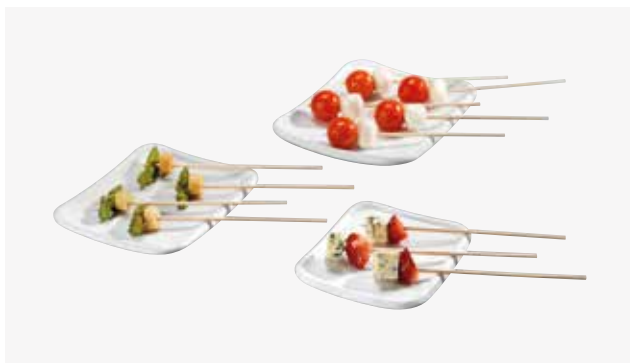
**P22104** Mini bandeja presentación / Mini square plate /  
Plateau miniature / Mini Buffettablett

REF	mm	H mm	U
P22.104	125 x 105	20	24
P22.105	140 x 130	20	24
P22.106	170 x 140	25	24

**P22107** Platillo concha / Shell saucer /  
Soucoupe coquille / Muscheltellerchen

REF	mm	H mm	U
P22.107	155 x 115	20	24

**P867** Recipiente para salsas / Ramekin /  
Ramequin / Sossengefäß

REF	ml	Ø mm	H mm	U
P867.030	30	50	23	12
P867.060	60	60	30	12
P867.090	90	70	35	12
P867.120	120	75	40	12

**P22890** Fuente rectangular / Small tray /  
Ravier rectangulaire / Rechteckiges Buffettablett

REF	mm	H mm	U
P22.890	130 x 90	20	24

Apilable/  
Stackable/  
Empilable/  
Stapelbar



**P22178** Taza / Cup / Tasse / Tasse  
Plato / Plate / Assiette / Unterteller



	REF	Size	Ø mm	H mm	Lts	U
TAZA / CUP / TASSE / TASSE	P22.178	S	70	48	0,10	12
PLATO / PLATE / ASSIETTE / UNTERTELLER	P22.180	L	98	65	0,25	12
	P22.179	S	103			12
	P22.181	L	144			12

**P22097** Panera redonda y oval /  
Round and oval bread basket /  
Corbeille à pain ronde et ovale /  
Runder und ovaler Brotkorb



REF	mm	H mm	U
P22.097	Ø 240	70	6
P22.098	275 x 210	70	6

**P22033** Cuchara perforada / Slotted spoon /  
Cuillère ajourée / Gelochter Löffel



REF	L mm	U
P22.033	300	24

**P22034** Cacillo / Soup ladle /  
Louche / Schöpflöffel



REF	L mm	Lts	U
P22.034	170	0,08	24

**P22110** Cuchara degustación / Party spoon /  
Cuillère amuse bouche / Verkostungslöffel



REF	mm	H mm	U
P22.110	145 x 45	50	60

**P22160** Vasija 1l / 1l crock /  
Cruche 1l / Gefäß 1l



REF	Ø mm	H mm	U
P22.160	130	105	6

## MELAMINA / MELAMINE / MÉLAMINE / MELAMIN

VAJILLA MELAMINA EXTRA FUERTE / HEAVY DUTY MELAMINE CROCKERY /  
VAISSELLE MÉLAMINE EXTRA FORTE / EXTRA HARTES MELAMIN GESCHIRR



### P2211

Plato / Round dish /  
Assiette plate / Teller



REF	Ø mm	H mm	U
P22.111	160	23	12
P22.112	200	23	12
P22.113	230	23	6
P22.114	265	23	6

### P22115

Plato sopa / Soup plate /  
Assiette à soupe / Suppenteller



REF	Ø mm	H mm	U
P22.115	240	37	6

### P22116

Bol grande / Big salad bowl /  
Saladier grand / Grosse Schüssel



REF	Ø mm	H mm	U
P22.116	190	50	6

### P22117

Bol pequeño / Small salad bowl /  
Saladier petit / Kleine Schüssel



REF	Ø mm	H mm	U
P22.117	140	60	12

### P22182

Plato oval / Oval dish /  
Assiette ovale / Ovaler Teller



REF	mm	H mm	U
P22.182	243 x 182	21	6
P22.183	305 x 232	25	6
P22.184	342 x 268	27	6

### P22118

Taza apilable / Stackable mug /  
Tasse empilable / Stapelbare Tasse



REF	Ø mm	H mm	Lts	U
P22.118	75	100	0,30	6



**P22030**

Cenicero redondo con tapa. Negro /  
Windproof ashtray round with lid. Black /  
Cendrier pour l'exterieur avec couvercle. Noir /  
Runder Aschenbecher mit Deckel. Schwarz



REF	Ø cm	H cm	U
P22.030	14,5	6,0	6

**P22031**

Cenicero redondo. Negro /  
Round dinner ashtray. Black /  
Cendrier rond. Noir /  
Runder Aschenbecher. Schwarz



REF	Ø cm	H cm	U
P22.031	10	5,0	12

**P22185**

Cenicero cónico melamina. Negro / Conical melamine ashtray. Black /  
Cendrier conique. Noir / Konischer Aschenbecher. Schwarz



REF	Ø cm	H cm	U
P22.185	10	2,7	24

**BOLS DOBLE PARET  
AHORA SON VOLLRATH**

**DOUBLE WALL BOWLS  
ARE NOW VOLLRATH**

**BOLS DOUBLE PAROI SONT MAINTENANT  
VOLLRATH**

**DOPPELWANDIGE SCHALEN  
IST JETZT VOLLRATH**



VER PRODUCTOS EN / SEE PRODUCTS ON / VOIR PRODUITS EN / SIEHE PRODUKTE IN **P. 102**



ESPAÑOL

CARRO SELF-SERVICE DE ACERO INOXIDABLE PARA BANDEJAS DE ANCHO 365 MM HASTA 420 MM. POSIBILIDAD DE INCORPORAR PLAFONES LATERALES COMPOSITE-ALUMINIO. PARA MÁS INFORMACIÓN VER EN PÁGINA 219

ENGLISH

SELF-SERVICE TROLLEY MADE OF ST/STEEL FOR TRAYS FROM 365 MM TO 420 MM WIDTH. AVAILABLE ALSO WITH TWO ALUMINIUM-COMPOSITE SIDE PANELS. FOR FURTHER INFORMATION REFER TO PAGE 219

FRANCAIS

CHARIOT SELF-SERVICE EN ACIER INOXYDABLE POUR PLATEAUX DE 365 MM À 420 MM. DISPONIBLE AUSSI AVEC DEUX PANNEAUX LATÉRAUX EN COMPOSITE-ALUMINIUM. POUR PLUS DE RENSEIGNEMENTS VEUILLEZ CONSULTER PAGE 219

DEUTSCH

SELBSTBEDIENUNGSWAGEN AUS ROSTFREIEM STAHL FÜR TABLETS DER BREITE 365 MM BIS 420 MM. DAS EINSETZEN VON SEITLICHEN ALUMINIUM-COMPOSIT WÄNDEN IST MÖGLICH. MEHR INFORMATIONEN AUF SEITE 219

## **P8074** Carro porta - cubiertos y bandejas / Trays and cutlery dispenser trolley / Chariot porte plateaux couverts / Besteck - und Tablettwagen



REF	mm	U
P80.740	810 x 570 x 1065	1

No incluye cubetas GN 1/3 ni bandejas.

Without 1/3 GN containers and trays.

Bacs GN 1/3 et plateaux pas inclus.

Behälter GN 1/3 und Tablett nicht inklusive.

Disponible también con ruedas poliamida. Consultar precio.

Available also on polyamide castors. Please ask for price.

Disponible aussi avec roulettes polyamide. Consulter prix.

Auch lieferbar mit Polyamidrädern. Bitte fragen Sie nach dem Preis.

**P8610** Bandeja fast - food fibra de vidrio / Fiberglass fast - food tray /  
Plateau fast food fibre de verre / Fiberglas fast - food Tablett



REF	mm	U
P861.045	455 x 355	12
P861.053	530 x 325	12

Color gris.  
Grey color.  
Couleur gris.  
Farbe grau.

**86100** Bandejas de polipropileno para comida rápida / Polypropylene Fast Food Trays /  
Plateaux de restauration rapide en polypropylene / Polypropylen - Imbisstabletts



+ 86 °C

Reciclable/  
Recyclable/  
Recyclable/  
Recyclingfähig



REF		cm	U
86100	●	25,4 x 35,6	24
86101	●	25,4 x 35,6	24
86103	●	25,4 x 35,6	24
86104	●	25,4 x 35,6	24
86105	●	25,4 x 35,6	24
86106	●	25,4 x 35,6	24
86107	●	25,4 x 35,6	24
86108	●	25,4 x 35,6	24
86109	●	25,4 x 35,6	24
86110	●	30,5 x 40,6	24
86111	●	30,5 x 40,6	24
86113	●	30,5 x 40,6	24
86114	●	30,5 x 40,6	24
86115	●	30,5 x 40,6	24
86116	●	30,5 x 40,6	24
86117	●	30,5 x 40,6	24
86118	●	30,5 x 40,6	24
86119	●	30,5 x 40,6	24
86120	●	35,6 x 45,7	12
86121	●	35,6 x 45,7	12
86123	●	35,6 x 45,7	12
86124	●	35,6 x 45,7	12
86125	●	35,6 x 45,7	12
86126	●	35,6 x 45,7	12
86127	●	35,6 x 45,7	12
86128	●	35,6 x 45,7	12
86129	●	35,6 x 45,7	12

El borde grueso reforzado con acanalados en las esquinas añade resistencia a los impactos. Cuatro cuñas de apilado para secar rápidamente y evitar que se peguen entre sí. Acabado texturizado entretejido semibrillante que aporta una superficie menos resbaladiza.

Thick reinforced rim with corner ribs add impact strength.  
Four stacking lugs speed drying and prevent sticking.  
Semi-gloss, weave-grain textured finish provides a reduced-slip surface.

Rebord reforcé épais avec nervures aux angles pour accroître la résistance aux chocs.  
Les quatre cales d'empilage accélèrent le séchage et empêchent les plateaux de coller entre eux. La texture tissée semi-brillante donne une surface moins glissante.

Dicker, verstärkter Rand mit Eckenrippen verbessert die Schlagfestigkeit.  
Vier Stapelnasen beschleunigen das Trocknen und verhindern ein Aneinanderhaften der Tablettts. Texturierte Maserung erzeugt eine rutschbeständige Oberfläche.

## COLECTIVIDADES / INSTITUTIONS / COLLECTIVITÉS / KOLLEKTIVITÄT

**P8070**

Soporte para bandejas porta - cubiertos /  
Counter - top cutlery dispenser /  
Support porte - couverts /  
Ständer für Besteckkasten



Compatible: REF. P900.000

No incluye bandeja portacubiertos / Cutterly bin not included /  
Bac ramasse - couverts non inclus / Besteckkasten nicht inklusive

REF	mm	U
P80.700	526 x 510 x 328	1

**P8071**

Soporte doble para bandejas porta - cubiertos /  
Double counter - top cutlery dispenser /  
Support double porte - couverts /  
Doppelständer für Besteckkasten



Compatible: REF. P900.000

No incluye bandeja portacubiertos / Cutterly bin not included /  
Bac ramasse - couverts non inclus / Besteckkasten nicht inklusive

REF	mm	U
P80.710	526 x 510 x 580	1

**P8072**

Soporte para 4 cubetas GN 1/3 /  
Counter - top dispenser for 4 GN containers 1/3 /  
Support pour 4 bacs GN 1/3 /  
Ständer für 4 Behälter GN 1/3



No incluyen cubetas GN / GN containers not included /  
Bacs GN non inclus / GN Behälter nicht inklusive

REF	mm	U
P80.720	738 x 310 x 430	1

**P8073**

Soporte para 8 cubetas GN 1/3 /  
Counter - top dispenser for 8 GN containers 1/3 /  
Support pour 8 bacs GN 1/3 /  
Ständer für 8 Behälter GN 1/3



No incluyen cubetas GN / GN containers not included /  
Bacs GN non inclus / GN Behälter nicht inklusive

REF	mm	U
P80.730	738 x 465 x 600	1

**P900**

Bandeja porta - cubiertos gastronorm 1/1 /  
1/1 gastronorm cutlery bin /  
Bac ramasse - couverts gastronorme 1/1 /  
Besteckkasten GN 1/1



Polipropileno alimentario / Food contact polypropylene /  
Polypropylène alimentaire / Polypropyten geeignet für den Lebensmittelkontakt

REF	mm	U
P900.000	530 x 325 x 100	1

**P340**

Bandeja auto - servicio acero inox /  
St/steel self - service tray /  
Plateau self - service acier inox /  
Selbstbedienungstablett rostfreier Stahl



6 Compartimentos / 6 Compartments /  
6 Compartiments / 6 Unterteilungen

REF	mm	H mm	U
P340.000	460 x 285	20	1



**P919** Bandeja isotérmica / Isothermal tray /  
Plateau Isotherme / Isothermisches Tablett



REF	mm	U
P919.000	530 x 370 x 110	1

Fabricada en polipropileno con interior aislante de poliuretano. Sin CFC.  
Made of polypropylene with insulating polyurethane without CFC interior.  
Fabriqué en polypropylène avec intérieur de polyuréthane sans CFC.  
Hergestellt aus Polypropylen mit Innenisolierung aus Polyurethan.  
Ohne CFC.

Adaptado para plato llano, hondo, bol, fuente rectangular en policarbonato, porcelana o melamina.  
Suitable for flat plate, soup plate, bowl, salad bowl on polycarbonate, chinaware or melamine.  
Apte pour assiettes plates, à soupe, bols, ravers, soit en polycarbonate, porcelaine ou melamine.  
Geeignet für flache und tiefe Teller, Schüssel, rechteckige Schale aus Polycarbonat, Porzellan oder Melamin.

Complementos no incluidos / Complements not included /  
Compléments non-inclus / Zubehör nicht inklusive

**P920** Platos policarbonato / Polycarbonate plates /  
Assiettes en polycarbonate / Polycarbonat Teller



Ref. 920.001

REF	Tipo / Type	Ø mm	H mm	U
P920.001	Llano / Flat / Plat / Flach	206	29	1
P920.002	Hondo / Soup / À soupe / Tief	185	45	1
P920.003	Desayuno / Breakfast / Petit déjeuner / Frühstück	175	25	1

Apto para lavavajillas y microondas /  
Dishwasher and microwave safe /  
Utilisable au lave-vaisselle et micro-ondes /  
Geeignet für Spülmaschinen und Mikrowellen

**P922** Fuente rectangular policarbonato /  
Polycarbonate rectangular bowl /  
Ravier rectangulaire en polycarbonate /  
Rechteckige Schale aus Polycarbonat



REF	mm	H mm	Lts	U
P922.000	95 x 138	45	0,25	1
P922.100*	96 x 139	24		1

Apto para lavavajillas y microondas /  
Dishwasher and microwave safe /  
Utilisable au lave-vaisselle et micro-ondes /  
Geeignet für Spülmaschinen und Mikrowellen

\*Tapa rígida /  
\*Rigid lid /  
\*Couvercle rigide /  
\*Harter Deckel

**P921** Bol doble pared policarbonato con tapa /  
Double wall polycarbonate bowl with lid /  
Bol polycarbonate double paroi avec couvercle /  
Doppelwändige Schüssel aus Polycarbonat mit Deckel



REF	Ø mm	H mm	Lts	U
P921.001	125	68	0,45	1

Apto para lavavajillas y microondas /  
Dishwasher and microwave safe /  
Utilisable au lave-vaisselle et micro-ondes /  
Geeignet für Spülmaschinen und Mikrowellen

**P923** Taza desayuno policarbonato /  
Polycarbonate breakfast cup /  
Tasse dessert polycarbonate /  
Frühstückstasse aus Polycarbonat



REF	Ø mm	H mm	Lts	U
P923.000	94	68	0,325	1
P923.001*	100			1

Apto para lavavajillas y microondas /  
Dishwasher and microwave safe /  
Utilisable au lave-vaisselle et micro-ondes /  
Geeignet für Spülmaschinen und Mikrowellen

\*Tapa /  
\*Lid /  
\*Couvercle /  
\*Deckel

## P924 Vaso policarbonato / Polycarbonate glass / Verre en polycarbonate / Polycarbonat Becher



REF	Color / Couleur	Ø mm	H mm	Lts	U
P924.001			102	0,25	1
P924.002			70	0,17	1
P924.002A			70	0,17	1
P924.002R			70	0,17	1
P924.002V			70	0,17	1



Apto para lavavajillas / Dishwasher safe  
Utilisable au lave-vaisselle / Spülmaschine geeignet

## P925 Carro transporte bandejas / Tray transport trolley / Chariot transport plateaux / Transportwagen

REF	MEDIDA GUÍAS MM / SIZE OF RAILS MM / DIMENSIONS GLISSIÈRES MM / GRÖSSE DER EINSCHÜBE	Nº GUÍAS / NR. OF LEVELS / NUM. NIVEAUX / NR. EINSCHÜBE	MEDIDAS TOTALES MM / TOTAL SIZES MM / MESURES TOTALES MM / GESAMTGRÖSSE	DISTANCIA ENTRE GUÍAS / DISTANCE BETWEEN LEVELS / ESPACÉ ENTRE NIVEAUX / ABSTAND DER EINSCHÜBE	U
P925.001	550 x 375	10	620 x 500 x 1520	120 mm	1
P925.002	550 x 375	20	620 x 920 x 1520	120 mm	1

Carro fabricado en acero inoxidable y guías de plástico. Ideal para el transporte de bandejas de distintas medidas, gracias al diseño especial de sus guías. Ruedas giratorias insonoras de Ø 125 mm.

Trolley made of St/Steel and plastic rails. Perfect for many different size trays transport thanks to the special rail design. Soundproof revolving castors Ø 125 mm.

Chariot fabriqué en acier inoxydable et glissières en plastique. Idéal pour le transport des plateaux de différentes mesures, grâce au design spécial des glissières. Roulettes insonores de Ø 125 mm.

Wagen hergestellt aus rostfreiem Stahl mit Plastikeinschüben. Ideal für den Transport von Tablettts verschiedener Grössen, dank seinem speziellen Design der Einschübe. Geräuschlose drehbare Räder Ø 125 mm.



Ref. P925.001



Ref. P925.002

**P26000** Alfombra / Mat / Tapis / Matte

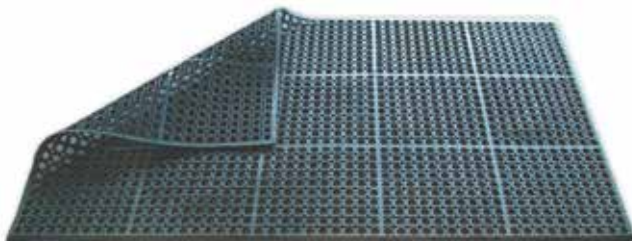

REF	cm	U
P26.000	90 x 150 x 1,20	1

✓ REACH  
COMPLIANT

**P26001** Alfombra / Mat / Tapis / Matte

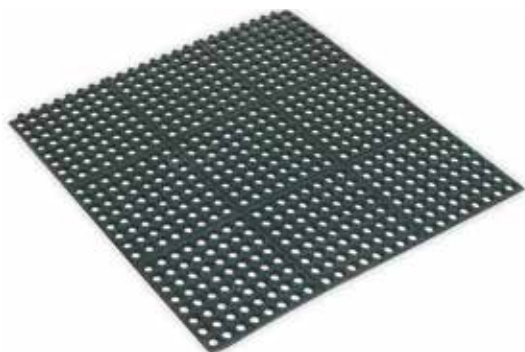

REF	cm	U
P26.001	90 x 90 x 1,20	1

✓ REACH  
COMPLIANT

Estas alfombras se pueden conectar unas con otras formando mayores superficies.  
You can connect these mats forming bigger surfaces.  
Avec système de liaison pour composer une surface plus grande.  
Für grössere Flächen kann man diese Matten mit anderen verbinden.



**P26002** Alfombra / Mat / Tapis / Matte



REF	cm	U
P26.002	90 x 150 x 1,20	1

Resistente al aceite.  
Oil resistant.  
Résistant à l'huile.  
Resistent gegen Öl.

**P26003** Alfombra / Mat / Tapis / Matten

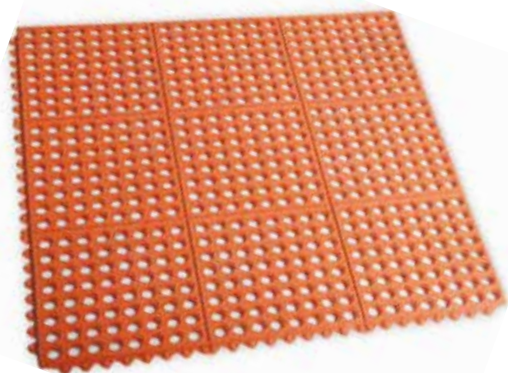

REF	cm	U
P26.003	90 x 90 x 1,20	1

Estas alfombras se pueden conectar unas con otras formando mayores superficies.  
You can connect these mats forming bigger surfaces.  
Avec système de liaison pour composer une surface plus grande.  
Für grössere Flächen kann man diese Matten mit anderen verbinden.

Resistente al aceite.  
Oil resistant.  
Résistant à l'huile.  
Resistent gegen Öl.



## SEÑALIZACIÓN / SIGNS / SIGNALISATION / MARKIERUNG

**P19100 / P19101 / P19113** Poste separación acero inoxidable / St/Steel barrier /  
Poteau acier inoxydable / Seperationspfosten rostfreier Stahl

REF	H cm	Kg	U
P19.100	95	10,5	1
P19.101	100	10,5	1
P19.113*	100	8,0	1

Ref. P19.100 : Pulido brillante / Mirror Polished /  
Polissage brillant / Glänzend poliert

Ref. P19.101 : Baño dorado / Golden coated /  
Doré / Goldbeschichtet

\*Poste separación aspecto madera /  
Barrier. Wooden looking /  
Poteau aspect bois /  
Seperationspfosten Holzlook

Cordón no incluido  
Belt not included  
Cordon non inclus  
Seil nicht inklusive

Ø 32 cm

**P19102** Poste separación con cinta roja retráctil / Barrier with red retractable belt system /  
Poteau dérouleur à sangle rouge / Seperationspfosten mit einziehbarem rotem Band

INOX - ST/STEEL  
ROSTFREIER STAHL



REF	H cm	L cm	Kg	U
P19.102	96	210	8	1

Cabezal fijo.  
Fix Head.  
Tête fixe.  
Fester Kopf.

**P19114** Poste con cinta retráctil. Brillante / Barrier with retractable belt. Mirror polished /  
Poteau dérouleur à sangle. Brillant / Pfosten mit einziehbarem rotem Band. Glänzend

INOX - ST/STEEL  
ROSTFREIER STAHL



REF	Color / Couleur	H cm	L cm	Kg	U
P19.114N	Negro / Black / Noir / Schwarz	94	200	9	1
P19.114A	Azul / Blue / Bleu / Blau	94	200	9	1
P19.114R	Rojo / Red / Rouge / Rot	94	200	9	1

Cabezal removable.  
Detachable head.  
Tête amovible.  
Kopf abnehmbar.



**P19115** Recambio cabezal poste / Spare head for barrier /  
Rechange de sangle / Ersatzkopf für Pfosten



REF	COLOR / COULEUR	L cm	U
P19.115-N	Negro / Black / Noir / Schwarz	200	1
P19.115-A	Azul / Blue / Bleu / Blau	200	1
P19.115-R	Rojo / Red / Rouge / Rot	200	1

Para poste ref. P19.114  
For barrier ref. P19.114  
Pour poteau réf. P19.114  
Für Pfosten Art. P19.114

**P19111** Cabezal pared cinta retráctil roja / Wall system barrier with red retractable belt /  
Poteau dérouleur pour mur à sangle rouge / Kopf für rotes einziebares Band mit Wandbefestigung

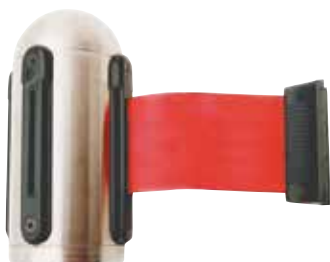

REF	L cm	U
P19.111	210	1

**P19116** Panel información / Information sign / Panneau information / Informationsschild



REF	cm	U
P19.116	21,8 x 32	1

Para ref. / For ref / Pour ref / Für Art. :  
P19.114

**P19105 / P19107 / P19103** Cordón con ganchos cromados / Belt with chromium-plated ends /  
Cordon à crochets chromés / Seil mit verchromten Haken



REF	Color / Couleur	L cm	U
P19.105	Burdeos / Burgundy / Bordeaux / Bordeauxrot	150	1
P19.107	Azul / Blue / Bleu / Blau	150	1
P19.103	Bronce / Plaited Bronze / Bronze / Bronze	150	1

**P19106 / P19108 / P19104** Cordón con ganchos dorados / Belt with golden ends /  
Cordon à crochets dorés / Seil mit vergoldeten Haken



REF	Color / Couleur	L cm	U
P19.106	Burdeos / Burgundy / Bordeaux / Bordeauxrot	150	1
P19.108	Azul / Blue / Bleu / Blau	150	1
P19.104	Bronce / Plaited Bronze / Bronze / Bronze	150	1

## SEÑALIZACIÓN / SIGNS / SIGNALISATION / MARKIERUNG

ESPAÑOL

FABRICADAS CON UN MATERIAL PLÁSTICO ESPECIAL QUE NO SE RAYA. MARCOS DE MADERA RESISTENTES AL AGUA Y AL SOL. PIZARRAS ESPECIALMENTE DISEÑADAS PARA EL USO DE TIZAS O ROTULADORES CON BASE DE AGUA.

ENGLISH

PRODUCED FROM SPECIAL PLASTIC COMPLETELY ANTI-SCRATH MATERIAL. SOLID WOOD FRAME DOUBLE-LACQUERED. RAIN AND SUNPROOF. WRITING-SURFACES SPECIALLY DESIGNED FOR USING WATER BASED CHALKMARKERS.

FRANÇAIS

FABRIQUÉS AVEC UN MATÉRIEL PLASTIQUE SPÉCIAL ANTI-RAYURES. CADRES EN BOIS MASSIF. RÉSISTANTS À LA PLUIE ET AU SOLEIL. TABLEAUX SPÉCIALEMENT CONÇUS POUR L'UTILISATION DES CRAIES OU MARQUEURS AVEC BASE À EAU.

DEUTSCH

HERGESTELLT AUS EINEM SPEZIELLEM PLASTIK, WELCHES NICHT VERKRATZT. RAHMEN AUS HOLZ RESISTENT GEGEN WASSER UND SONNE. SPEZIELLES TAFELDESIGN FÜR DEN GEBRAUCH VON KREIDE UND FILZSTIFTEN.

**P21000 / P21001** Caballete - Duo

REF	A cm	B cm	U
P21.000	75	135	1
P21.001	55	85	1

**P21003** Caballete - Uno

REF	A cm	B cm	U
P21.003	55	85	1

**P2100** Universal

REF	A cm	B cm	U
P21.004	40	50	1
P21.005	50	60	1
P21.006	60	80	1
P21.007	70	90	1
P21.008	80	100	1

**P21013 / P21014** Curva

REF	A cm	B cm	U
P21.013	50	80	1

**P2101** Lucky



REF	A cm	B cm	U
P21.015	10	15	1
P21.016	15	21	1
P21.017	21	30	1

**P2102** Basic

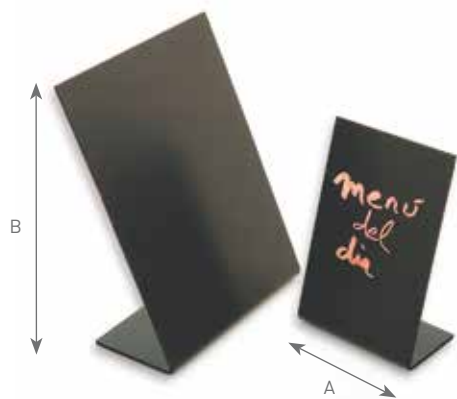

REF	A cm	B cm	U
P21.027	10	15	1
P21.028	15	23	1
P21.029	21	31	1

**P21020-26** Marcadores tiza fluorescentes, grueso 2 - 6 mm / Fluorescent Chalkmarkers widths, 2 - 6 mm / Marqueurs fluorescents épaisseur, 2 - 6 mm / Fluoreszierende Kreidemarker, Breite 2 - 6 mm



REF	COLOR / COLOUR / COULEUR / FARBE	U
P21.020	Blanco / White / Blanc / Weiss	1
P21.023	Amarillo / Yellow / Jaune / Gelb	1
P21.025	Naranja / Orange / Orange / Orange	1

Resistentes a la lluvia. Fácil de borrar con un trapo húmedo /  
Rainproof. Easy to wipe off with damp cloth /  
Résistants à la pluie. S'efface facilement avec un chiffon humide /  
Resistent gegen Regen. Einfach zu löschen mit einem feuchten Tuch





**HELADERÍA Y PASTELERÍA /**  
ICE-CREAM UTENSILS & PASTRY /  
USTENSILES À GLACE ET PÂTISSERIE /  
ZUBEHÖR FÜR EISCREME UND PATISSERIE

- |            |  |     |
|------------|--|-----|
| <b>6.1</b> | HELADERÍA /<br>ICE-CREAM UTENSILS /<br>USTENSILES POUR GLACE/<br>ZUBEHÖR FÜR EISCREME                          | 330 |
| <b>6.2</b> | UTENSILIOS DE PASTELERÍA /<br>PASTRY UTENSILS /<br>USTENSILES DE PÂTISSERIE /<br>PATISSERIEZUBEHÖR             | 336 |
| <b>6.3</b> | MOLDES ANTIADHERENTES /<br>NON-STICK MOULDS /<br>MOULES ANTI-ADHÉSIFS /<br>ANTIHAFT BACKFORMEN                 | 348 |
| <b>6.4</b> | CORTAPASTAS /<br>PASTRY CUTTER /<br>DÉCOUPOIRS /<br>TEIGSCHNEIDER  | 352 |
| <b>6.5</b> | MOLDES ACERO INOXIDABLE /<br>ST/STEEL PASTRY MOULDS /<br>MOULES EN ACIER INOX /<br>BACKFORMEN ROSTFREIER STAHL | 353 |
| <b>6.6</b> | MANGAS Y BOQUILLAS /<br>BAGS AND TUBES /<br>POCHES ET DOUILLES /<br>SPRITZBEUTEL UND TÜLLEN                    | 357 |
| <b>6.7</b> | MOLDES SILICONA /<br>SILICONE MOULDS /<br>MOULES SILICONE /<br>SILIKONBACKFORMEN                               | 362 |
| <b>6.8</b> | MOLDES FLEXIPAN /<br>FLEXIPAN MOULDS /<br>MOULES FLEXIPAN /<br>FLEXIPANBACKFORMEN                              | 368 |



### 47274 Racionador helado / Ice cream scoop / Cuillère à glace / Eiskungelportionierer

REF	COLOR	TAMAÑO	cm	Mlts	U
47274	●	10	19,5	120	12
47275	●	12	19,5	90	12
47276	●	16	19,5	75	12
47277	●	20	19,0	60	12
47278	●	24	19,5	45	12
47279	●	30	19,0	30	12



**47245** Racionador helado / Squeeze dishers / Cuillères de service à presser / Eisportionierer

REF	FORMA	cm	Mlts	U
47245	△	4,5 x 4,8	37	10
47246	◇	6,7 x 4,6	37	10
47247	□	5,6 x 4,1	37	10
47248	◐	3 x 5,6	37	10

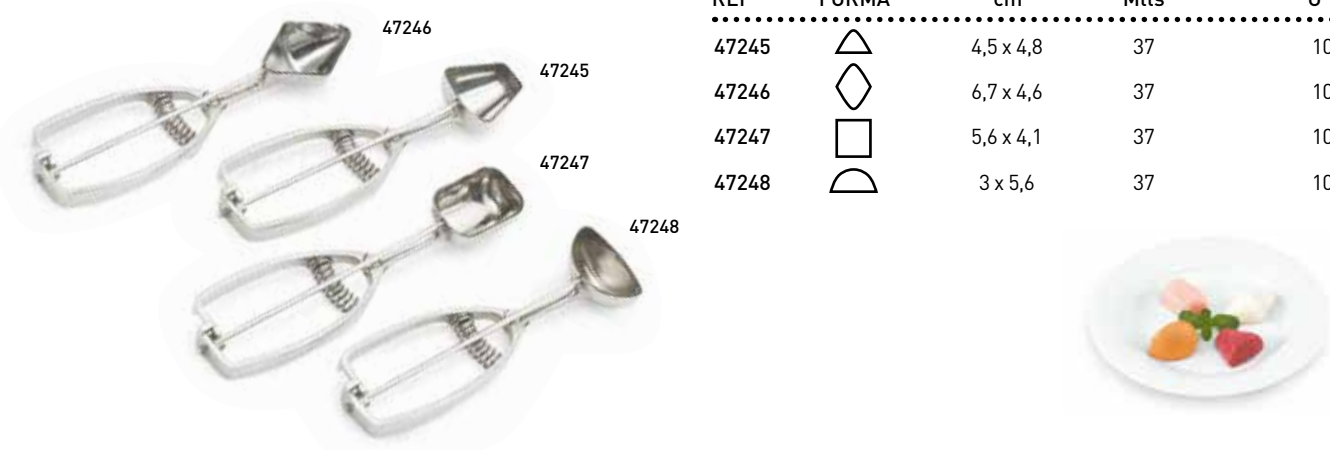

**47169** Racionador ovalado / Oval squeeze disher / Doseur à presser oval / Ovale Eisportionierer

REF	TAMAÑO	cm	Mlts	U
47169	14	7 x 5,5	68	10
47170	20	6,3 x 4,8	46	10
47171	24	5,8 x 4,6	38	10
47172	30	5,3 x 4,1	28	10
47200	40	5 x 3,6	22,2	10



**47150** Racionador helado / Round Squeeze Disher / Doseur à presser ronde / Runde Eisportionierer

REF	TAMAÑO	cm	Mlts	U
T7206	6	23,2	157,6	12
47150	8	23,2	118,3	12
47151	10	22,5	92,4	12
47152	12	22,5	81,3	12
47153	16	21,6	59,1	12
47154	20	21,6	44,4	12
47155	24	21	40,7	12
47156	30	21	37	12
47157	40	20,3	25,9	12
47158	50	20	18,5	12
47159	60	19,7	16,6	12
47160	70	19,7	14,3	12
47161	100	19,1	11,1	12



**P331** Racionador de helado / Ice cream scoop / Cuillère à glace / Eiskugelportionierer

REF	Ø mm	Mlts	U
P331.039	39	15	12
P331.044	44	22	12
P331.050	50	32	12
P331.056	56	46	12
P331.059	59	54	12
P331.066	66	75	12
P331.070	70	90	12



**P908** Racionador de helado / Ice cream scoop / Cuillère à glace / Eiskugelportionierer

REF	COLOR / COLOUR / COULEUR FARBE	L cm	U
P908.000	Blanca / White / Blanc / Weiss	26	1
P908.001*	Transparente / Clear / Trasparente / Transparent	26	1
P908.002	Roja / Red / Rouge / Rot	26	1
P908.003	Azul / Blue / Bleu / Blau	26	1
P908.004	Amarilla / Yellow / Jaune / Gelb	26	1



\*Metacrilato /  
Methacrylate /  
Méthacrylate /  
Metaakrylat

**P332** Copa helado / Ice cream cup / Coupe à glace / Eisschale

REF	Ø cm	H cm	Lts	U
P332.095	9,5	8,5	0,15	1
P332.010	10,5	6	0,17	12

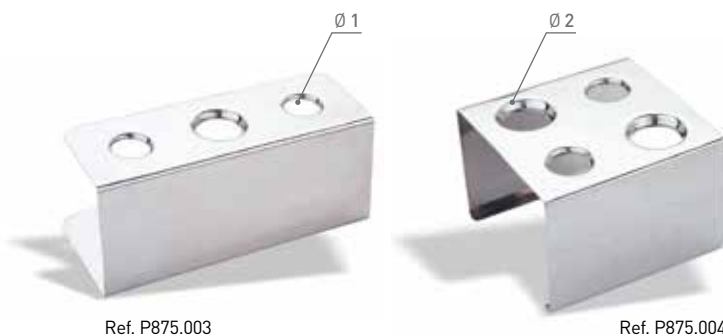
**P875** Soporte para cucuruchos / Cornet stand / Support pour cornets / Eiswaffelständer

REF	cm	U
P875.003	21 x 7 x 8,5	1
P875.004	12 x 12 x 7,5	1

Ø 1 25 mm  
Ø 2 32 mm

VER PRODUCTOS EN / SEE PRODUCTS ON / VOIR PRODUITS EN / SIEHE PRODUKTE IN

**GELATO 5K CREA SC**

LA MANTECADORA MÁS COMPACTA TOTALMENTE AUTOMÁTICA /  
THE MOST COMPACT COMPLETELY AUTOMATIC ICE-CREAM MAKER /  
LA TURBINE À GLACE LA PLUS COMPACTE TOTALEMENT AUTOMATIQUE /  
DIE KOMPAKTESTE VOLLAUTOMATISCHE EISMASCHINE



P. 244



**P914** 360 x 165 mm



Acero inox 18/10  
18/10 St/Steel  
Acier inox 18/10  
Edelstahl 18/10

REF	mm	H mm	Lts	U
P914.080	360 x 165	80	3,4	10
P914.120	360 x 165	120	5	10
P914.150	360 x 165	150	7	10

**P915** 360 x 250 mm



Acero inox 18/10  
18/10 St/Steel  
Acier inox 18/10  
Edelstahl 18/10

REF	mm	H mm	Lts	U
P915.080	360 x 250	80	5,4	10
P915.150	360 x 250	150	11	10

**P9161** 360 x 165 mm



Policarbonato.  
Polycarbonate.  
Polycarbonate.  
Polycarbonat.

REF	mm	H mm	Lts	U
P916.120	360 x 165	120	5	10

**P917** 360 x 250 mm



Policarbonato.  
Polycarbonate.  
Polycarbonate.  
Polycarbonat.

REF	mm	H mm	Lts	U
P917.080	360 x 250	80	3,4	10

**P9160** Tapa policarbonato /  
Polycarbonate lid /  
Couvercle en polycarbonate /  
Deckel Polycarbonat



Adaptable a cubetas heladería inox y policarbonato.  
Adjustable for St/Steel Ice cream containers.  
Adaptable aux récipient à glace en acier inox.  
Passend für Eisbehälter Edelstahl und Polycarbonat.

REF	mm	U
P916.000	360 x 165	10

**P918** Lava - racionador acero inoxidable /  
St/steel scoop - washer /  
Rince - cuillères acier inoxydable /  
Eisportioniererspüle rostfreier Stahl



REF	mm	U
P918.000	375 x 195 x 270	1

# PASTELERÍA

ESPAÑOL

PUJADAS OFRECE UN AMPLIO ABANICO DE MOLDES, AROS Y FORMAS DE EXTRAORDINARIA SOLIDEZ Y FABRICADOS EN DIVERSOS MATERIALES DE MÁXIMA CALIDAD. IDEALES PARA QUE EL PROFESIONAL PUEDA LLEVAR A CABO SUS MÁS SOFISTICADAS CREACIONES DE REPOSTERÍA.

TAMBIÉN SE PRESENTAN MULTITUD DE ARTÍCULOS COMPLEMENTARIOS PROPIOS DEL OFICIO DE LA PASTELERÍA PARA QUE EL PROFESIONAL REPOSTERO PUEDA REALIZAR SUS LABORES CREATIVAS EN LAS MEJORES CONDICIONES.

## 1. ANTIADHERENTE:

MOLDES CON CALIDAD PROFESIONAL. ANTIADHERENTE PTFE DE DOBLE CAPA QUE ASEGURA UNA MAYOR RESISTENCIA A LA ABRASIÓN, EXCELENTE ANTIADHERENCIA, MAYOR DURACIÓN DEL MOLDE Y GRAN FACILIDAD DE LIMPIEZA.

## 2. ACERO INOXIDABLE:

POR SUS CUALIDADES HIGIÉNICAS, EL ACERO INOXIDABLE HA IDO TOMANDO POSICIONES TAMBIÉN EN EL SECTOR DE LA PASTELERÍA. AQUÍ LE PRESENTAMOS UNA VARIADA GAMA DE AROS Y FORMAS.

## 3. MOLDES DE SILICONA:

FLEXIBLES Y ANTIADHERENTES. FÁCIL DE DESMOLDAR Y LIMPIAR. CUMPLEN LAS NORMAS DE USO ALIMENTARIO HACCP

## 4. MOLDES FLEXIPAN®

EL FLEXIPAN® ES UNA COMBINACIÓN DE FIBRAS DE VIDRIO Y SILICONA ADECUADAS PARA EL USO ALIMENTARIO.

EL FLEXIPAN® PERMITE REALIZAR CUALQUIER TIPO DE PREPARACIONES DULCES O SALADAS, TANTO EN COCCIÓN (+280 °C) O EN CONGELACIÓN (-40 °C).

# PASTRY

ENGLISH

PUJADAS OFFERS AN EXTENSIVE ARRAY OF EXTREMELY RESISTANT MOULDS, RINGS AND FORMS IN VARIOUS MATERIALS OF THE HIGHEST QUALITY. IDEALLY SUITED FOR PROFESSIONALS DEVOTED TO THE CREATION OF THEIR MOST SOPHISTICATED WORKS OF ART.

A LARGE NUMBER OF ANCILLARY ITEMS ARE ALSO INTRODUCED TO ENABLE PROFESSIONAL PASTRY COOKS AND CONFECTIONERS TO CARRY OUT THEIR CREATIVE WORK IN THE BEST POSSIBLE CONDITIONS

## 1. NON-STICK MOULDS:

PROFESSIONAL QUALITY MOULDS. DOUBLE-PLY NON-STICK PTFE TO GUARANTEE THE BEST POSSIBLE RESISTANCE TO ABRASION, EXCELLENT NON-STICK CHARACTERISTICS. VERY EASY TO CLEAN AND LONG LASTING.

## 2. ST/STEEL MOULDS:

DUE TO THEIR HYGIENIC QUALITIES, ST/STEEL HAS ALSO BEEN INTRODUCED AND IT IS NOW REALLY VALUED IN THE PASTRY. THIS SERIES INTRODUCES A WIDE RANGE OF RINGS AND MOULDS.

## 3. SILICON MOULDS:

FLEXIBLE AND NON-STICK. EASY REMOVAL AND EASY TO CLEAN. SUITABLE FOR FOOD CONTACT AS PER INTERNATIONAL REGULATIONS HACCP.

## 4. FLEXIPAN® MOULDS

THE FLEXIPAN® IS A SILICONE AND FIBRE GLASS COMBINATION MOULD SUITABLE FOR THE FOOD CONTACT.

THE FLEXIPAN CAN BE USED TO BAKE (+280 °C) OR FREEZE (-40 °C) THE MOST SWEET AND SAVOURY PRODUCTS.



# PÂTISSERIE

FRANÇAIS

PUJADAS PROPOSE UN LARGE ÉVENTAIL DE MOULES, CERCLES ET FORMES TRÈS ROBUSTES, FABRIQUÉS AVEC DIFFÉRENTS MATÉRIAUX D'UNE QUALITÉ MAXIMALE POUR PERMETTRE AU PROFESSIONNEL DE RÉALISER DES CRÉATIONS DE PÂTISSERIE LES PLUS SOPHISTIQUÉES. PUJADAS PROPOSE ÉGALEMENT DE NOMBREUX ARTICLES COMPLÉMENTAIRES PARTICULIERS À LA PÂTISSERIE POUR PERMETTRE AU PÂTISSIER DE MENER À TERME SES TÂCHES DE CRÉATION DANS LES MEILLEURES CONDITIONS POSSIBLES

## 1. MOULES ANTI-ADHÉSIFS:

MOULES DE QUALITÉ PROFESSIONNELLE. ANTI-ADHÉSIF PTFE DE DOUBLE COUCHE POUR ASSURER UNE MEILLEURE RÉSISTANCE À L'ABRASION. EXCELLENTE ANTI-ADHÉRENCE, LONGUE DURÉE DU MOULE ET NETTOYAGE TRÈS FACILE.

## 2. MOULES EN ACIER INOX:

POUR SES CARACTÉRISTIQUES HYGIENIQUES, L'ACIER INOXYDABLE EST DEvenu UN MATÉRIEL IMPORTANT EN PÂTISSERIE. NOUS VOUS PRÉSENTONS ICI UNE GAMME TRÈS COMPLÈTE DE MOULES ET FORMES.

## 3. MOULES EN SILICONE:

FLEXIBLES ET ANTI-ADHÉSIFS. RAPIDE ET FACILE DÉMOULAGE. MINIMUM D'ENTRETIEN. CES MOULES SONT CONFORMES AU CONTACT ALIMENTAIRE SELON LES NORMES INTERNATIONALES CERTIFIÉES HACCP.

## 4. MOULES FLEXIPAN®

LE FLEXIPAN® EST UNE COMBINAISON DE TISSUES DE VERRE ET SILICONES ADÉQUATS POUR L'UTILISATION ALIMENTAIRE.

LE FLEXIPAN® PERMET D'EFFECTUER TOUS TYPES DE PRÉPARATIONS SUCRÉES OU SALÉES, EN CUISSON (+ 280 °C) OU EN CONGÉLATION (-40 °C).

# PATISSERIE

DEUTSCH

PUJADAS BIETET EINE GROSSE ANZAHL VON SCHABLONEN, RINGEN UND FORMEN VON AUSSERGEWÖHNLICHER FESTIGKEIT AUS VERSCHIEDENEN MATERIALIEN HÖCHSTER QUALITÄT AN. IDEAL FÜR JEDEN PROFI, DER DIE HÖCHSTENTWICKELTEN NACHSPEISEN KREIREN MÖCHTE.

AUCH PRÄSENTIEREN WIR IHNEN EINE VIELZAHL VON KONDITOREIEIGENEN ZUBEHÖRARTIKELN, MIT DENEN DER PROFESSIONELLE KONDITOR SEINE KREATIVSTEN ARBEITEN UNTER DEN BESTEN BEDINGUNGEN REALISIEREN KANN.

## 1. ANTIHAFTEND:

RAHMEN PROFESSIONELLER QUALITÄT. DOPPELTE ANTIHAFTBESCHICHTUNG PTFE, WELCHE DIE HÖCHSTE RESISTENZ GEGEN DEN VERSCHLEISS GARANTIIERT, EXCELLENTE ANTIHAFTUNG, HÖCHSTE LEBENSDAUER DER RAHMEN UND EINFACHSTE REINIGUNG.

## 2. ROSTFREIER STAHL:

AUFGRUND SEINER HYGIENISCHEN EIGENSCHAFTEN HAT DER ROSTFREIE STAHL AUCH SEINEN PLATZ IN DEM SEKTOR DER KONDITOREI EINGENOMMEN. HIER PRÄSENTIEREN WIR IHNEN VERSCHIEDENE SERIEN VON RINGEN UND FORMEN.

## 3. SILIKONRAHMEN:

FLEXIBEL UND ANTIHAFTEND. EINFACH VOM RAHMEN ZU LÖSEN UND ZU REINIGEN. ERFÜLLEN DIE NORMEN FÜR DIE LEBENSMITTELVERARBEITUNG ENTSPRECHEND HACCP.

## 4. FORMEN FLEXIPAN®

FLEXIPAN® IST EINE KOMBINATION AUS FIBERGLAS UND SILIKON ANGEPASST AN DIE LEBENSMITTELVERARBEITUNG.

FLEXIPAN® ERLAUBT ES JEDWEDIGE ART DER VORBEREITUNG VON NACHSPEISEN ZU REALISIEREN, SOWOHL BACKEN (+280 °C) ALS AUCH EINFRIEREN (-40 °C).



**P304** Cazo bombeado / Conical saucepan / Casserole bombée / Kugelförmige Stielkasserole

INOX - ST/STEEL  
EDELSTAHL  
18/10



REF	Ø cm	H cm	Lts	U
P304.016	16	7,5	1,00	1
P304.018	18	8,0	1,70	1
P304.020	20	10,0	2,50	1
P304.022	22	11,5	3,70	1
P304.024	24	12,0	4,50	1

**P3070** Caldero fondo plano / Boiler / Bassine à fond plat / Kessel ebener Boden

INOX - ST/STEEL  
EDELSTAHL  
18/10



REF	Ø cm	H cm	Lts	U
P307.020	20	10,5	2,20	1
P307.025	25	11,5	3,50	1
P307.030	30	14,0	6,00	1
P307.035	35	14,5	8,50	1
P307.040	40	16,5	13,00	1
P307.045	45	17,5	20,00	1
P307.050	50	20,0	25,00	1
P307.060	60	22,5	45,00	1
P307.070	70	24,5	65,00	1

**P3072** Caldero con fondo difusor / boiler with sandwich bottom / Bassine à fond plat avec fond thermo-diffuseur / Kessel mit Sandwichboden

INOX - ST/STEEL  
EDELSTAHL  
18/10



REF	Ø cm	H cm	Lts	U
P307.230	30	14,2	6,00	1
P307.240	40	16,0	13,50	1

**P3071** Caldero fondo bombeado / Conical boiler / Bassine à fond bombé / Kessel kugelförmiger Boden

INOX - ST/STEEL  
EDELSTAHL  
18/10



REF	Ø cm	H cm	Lts	U
P307.125	25	13,0	3,80	1
P307.130	30	16,0	6,50	1
P307.140	40	19,0	13,00	1
P307.150	50	23,5	25,00	1

**P306** Caldero timbal / Mixing boiler / Bol mixeur / Rührschüssel

INOX - ST/STEEL  
EDELSTAHL  
18/10



REF	Ø cm	H cm	Lts	U
P306.035	35	18,0	10,00	1

Una sola asa.  
Only one handle.  
Une seule anse.  
Nur ein Griff.



**P356** Fuente honda cónica / Kitchen bowl / Bassine pâtissière / Rührschüssel

INOX - ST/STEEL  
EDELSTAHL  
18/10



REF	Ø cm	H cm	Lts	U
P356.016	16	5,5	0,65	1
P356.020	20	7,5	1,30	1
P356.024	24	8,5	2,10	1
P356.028	28	11,0	3,70	1
P356.032	32	12,5	6,00	1

Medidas exteriores / Outer sizes /  
Dimensions extérieures / Aussenmasse

**P107** Caldero fondo plano / Conical boiler / Bassine à fond plat / Kessel ebener Boden

ALUMINIO /  
ALUMINIUM



REF	Ø cm	H cm	Lts	U
P107.040	40	16,5	13,00	1
P107.050	50	19,5	25,00	1
P107.060	60	23,5	45,00	1

**P951** Librador de acero inox / St/steel scoop / Pelle à farine en acier inox / Mehlschaufel rostfreier Stahl



REF	L cm	Lts	U
P951.010	10	0,10	5
P951.015	15	0,40	5
P951.019	19	1,00	5
P951.024	24	1,70	5

**P953** Librador aluminio / Aluminium scoop / Pelle à farine aluminium / Mehlschaufel Aluminium



REF	L cm	Lts	U
P953.001	11	0,15	12
P953.002	15	0,35	12
P953.003	18,5	0,71	12
P953.004	21,5	1,10	12
P953.005	25,5	1,71	12

**P952** Librador policarbonato / Polycarbonate scoop / Pelle à farine polycarbonate / Mehlschaufel Polycarbonat

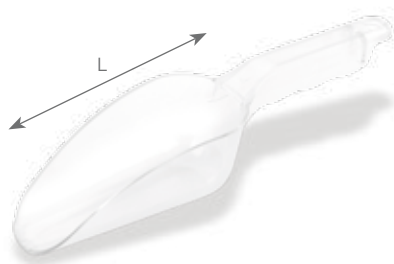

REF	L cm	Lts	U
P952.001	13	0,17	12
P952.002	15,5	0,35	12
P952.003	17,5	0,71	12

### P316 Batidor (12 varillas) / Whisk (12 wires) / Fouet (12 fils) / Rührbesen (12 Drähte)

Grueso varilla / Wire thickness / Epaisseur des fils / Drahtdicke : 1,3 mm



REF	L cm	U
P316.025	25	12
P316.030	30	12
P316.035	35	12
P316.040	40	12
P316.045	45	12
P316.050	50	12

### P3161 Batidor (10 varillas) / Whisk (10 wires) / Fouet (10 fils) / Rührbesen (10 Drähte)

Grueso varilla / Wire thickness / Epaisseur des fils / Drahtdicke : 1,8 mm



REF	L cm	U
P316.125	25	12
P316.130	30	12
P316.135	35	12
P316.140	40	12
P316.145	45	12
P316.150	50	12

### P354 Batidor grueso (8 varillas) / Heavy whisk (8 wires) / Fouet épais (8 fils) / Rührbesen (8 Drähte)

Grueso varilla / Wire thickness / Epaisseur des fils / Drahtdicke : 2,4 mm



REF	L cm	U
P354.025	25	12
P354.030	30	12
P354.035	35	12
P354.040	40	12
P354.045	45	12
P354.050	50	12

### P959 Batidor mango abs antideslizante (8 varillas) / Whisk with anti-slip abs handle (8 wires) / Fouet avec poignée abs anti-crispation (8 fils) / Rührbesen Antirutschgriff ABS (7 Drähte)

Grueso varilla / Wire thickness / Epaisseur des fils / Drahtdicke : 2 mm

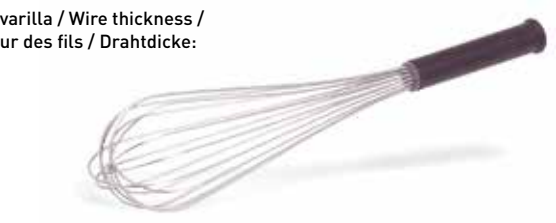

REF	L cm	U
P959.025	25	12
P959.030	30	12
P959.035	35	12
P959.040	40	12
P959.045	45	12
P959.050	50	12

### P393 Batidor gigante / Big whisk / Fouet à purée / Grosser Rührbesen

Grueso varilla / Wire thickness / Epaisseur des fils / Drahtdicke : 3 mm

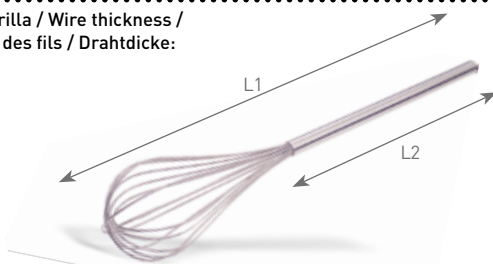

REF	L1 cm	L2 cm	U
P393.080	80	45	1
P393.100	100	65	1
P393.125	125	90	1

### P3166 Batidor bolas / Ball whisk / Fouet à boules / Kugelrührbesen



REF	L cm	U
P316.630	30	1
P316.635	35	1
P316.640	40	1

### P3165 Batidor rotatorio / Rotatory whisk / Fouet rotatif / Drehbarer Rührbesen



REF	L cm	U
P316.530	30	12

**P398** Espátula de goma / Rubber spatula /  
Spatule en caoutchouc / Gummispachtel



REF	L cm	U
P398.024	23	24
P398.035	33	12
P398.042	41	12

**P398290** Espátula estrecha goma /  
Narrow rubber spatula /  
Spatule étroite en caoutchouc /  
Gerade Gummispachtel

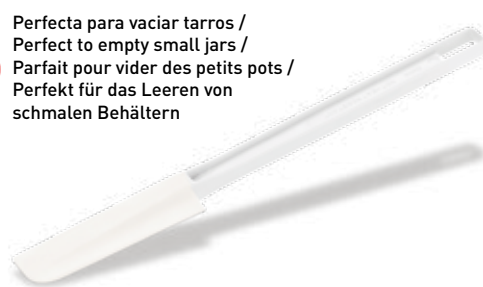

Perfecta para vaciar tarros /  
Perfect to empty small jars /  
Parfait pour vider des petits pots /  
Perfekt für das Leeren von  
schmalen Behältern

REF	PALA / PEEL / PELLE / SCHAUFEL cm	L cm	U
P398.290	8,8 x 3,3	25,5	24

Mango ergonómico. Goma aceptada para uso alimentario. Puede lavarse en el lavavajillas. Moldeado especial que previene la separación de la goma del mango. Anatomical handle. Suitable rubber for food contact. Safe dishwasher. Special mould that prevents the rubber to come off from the handle. Manche anatomique. Caoutchouc conforme au contact alimentaire. Utilisable au lave-vaisselle. Moulage spécial pour éviter la séparation de la gomme du manche. Ergonomischer Griff. Gummi geeignet für die Lebensmittelverarbeitung. Spülmaschinenfest. Spezieller Rahmen, der das Trennen von Gummi und Stiel vorsieht.

**P3981** Espátula silicona alta temperatura / High  
heat silicone spatula. Bowl scraper /  
Spatule silicone haute température /  
Silikonspachtel hohe Temperaturen



REF	PALA / PEEL / PELLE / SCHAUFEL cm	L cm	U
P398.125	9 x 6	25	24
P398.135	11 x 7	35	12
P398.140	11 x 7	40	12

Resistente hasta 260 °C / Heat resistance to 260 °C /  
Résistante à 260 °C / Hitzeresistent bis 260 °C

**P3982** Cuchara silicona alta temperatura /  
High heat silicone spoon /  
Cuillère silicone haute température /  
Silikonlöffel hohe Temperaturen



REF	PALA / PEEL / PELLE / SCHAUFEL cm	L cm	U
P398.225	9 x 6	25	1
P398.235	11 x 7	35	1
P398.240	11 x 7	40	1

Resistente hasta 260 °C / Heat resistance to 260 °C /  
Résistante à 260 °C / Hitzeresistent bis 260 °C

**P9602** Espátula multi-usos / Multi-purpose spatula / Spatule multi-usage / Spachtel Multigebrauch

● -5 °C  
● +70 °C



REF	L cm	U
P960.225*	25	1
P960.230*	30	1
P960.235**	35	1

\*Poliestireno / Polystyrene / Polystyrène / Polystyroen  
\*\*Polietileno / Polyethylene / Polyéthylène / Polyethylen

**P807** Rodillo para perforar pasta / Roller docker / Rouleau pour piquer pâtes / Stipprolle

REF	U
P807.000	1

**P839** Rodillo perforar pasta / Roller docker / Rouleau pour piquer pâtes / Stipprolle

REF	U
P839.000	1

**P840** Rodillo enrejado / Lattice cutting roller / Rouleau découpoir / Gitterschneiderrolle

REF	U
P840.000	1

**P842** Cortapastas doble. Liso y rizado / Double pastry cutter. Plain and serrated / Roulette à pâtes double. Unie et cannelée / Doppelter Teigschneider. Glatt und Gezackt

REF	U
P842.000	1

**P805** Cortapastas extensible 7 ruedas / Extendable cutter roller 7 castors / Rouleau extensible 7 roulettes / Ausziebarer Teigschneider 7 Rollen

REF	U
P805.000	1



**P801**

Rodillo acero inox /  
St/Steel rolling pin /  
Rouleau pâtissier acier inox /  
Teigrolle rostfreier Stahl

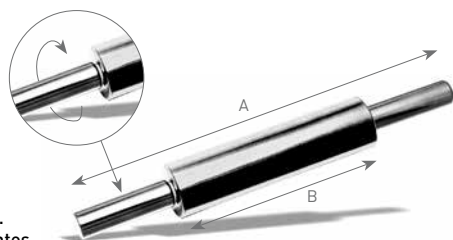

Asas giratorias.  
Rolling handles.  
Poignées roulantes.  
Drehende Griffe.

REF	A cm	B cm	Ø cm	U
P801.040	40	20	5,1	3
P801.048	48	25	6,4	3

**P802**

Rodillo polietileno con asas /  
Polyethylene rolling pin with handles /  
Rouleau en polyéthylène avec poignées /  
Teigrolle Polyethylen mit Griffen

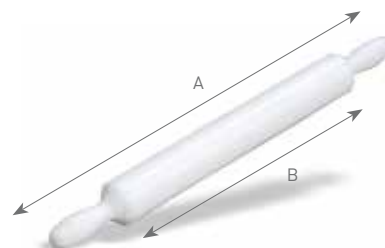

REF	A cm	B cm	Ø cm	U
P802.000	60	40	4,8	1

**P803**

Rodillo polietileno sin asas /  
Polyethylene rolling Pin without handles /  
Rouleau en polyéthylène Sans poignées /  
Teigrolle Polyethylen ohne Griffen



REF	L cm	Ø cm	U
P803.000	50	4,8	1

**P804**

Rodillo de madera / Wooden rolling pin /  
Rouleau en bois / Holzteigrolle

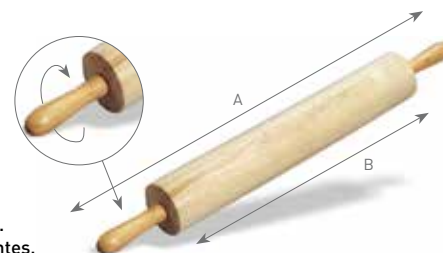

Asas giratorias.  
Rolling handles.  
Poignées roulantes.  
Drehende Griffe.

REF	A cm	B cm	Ø cm	U
P804.000	67,5	45,5	7,7	1

**P845**

Pincel de polipropileno /  
Polypropylene brush /  
Pinceau en polypropylène /  
Pinsel Polypropylen

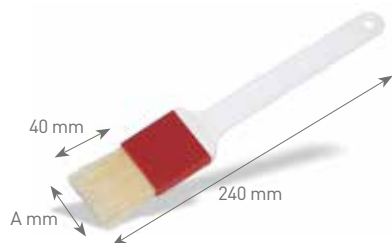

REF	A mm	U
P845.040	40	1
P845.050	50	1
P845.060	60	1
P845.075	75	1

**P8451**

Cepillo plástico + cerdas nylon /  
Plastic brush + nylon bristle /  
Pinceau plastique + poils nylon /  
Plastikbürste + Nylonborsten

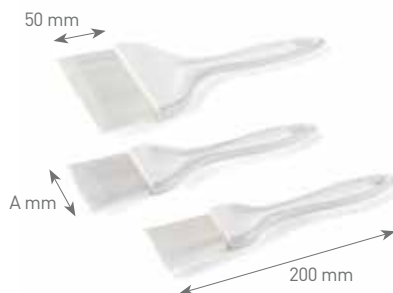

REF	A mm	U
P845.138	38	1
P845.155	55	1
P845.110	100	1

**P8452**

Cepillo cerdas nylon con soporte olla /  
Nylon bristles brush with hook for pot /  
Pinceau poils nylon avec support pot /  
Bürste Nylonborsten mit Topfhalterung

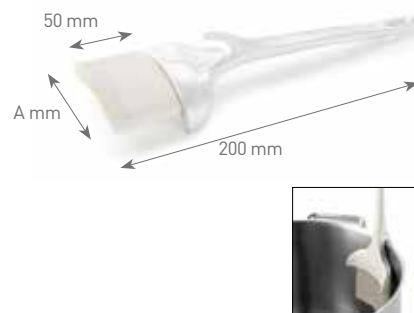

REF	A mm	U
P845.275	75	1

## P836 Rasquetas de polipropileno / Polypropylene scrapers / Raclettes en polypropylène / Schaber aus Polypropylen

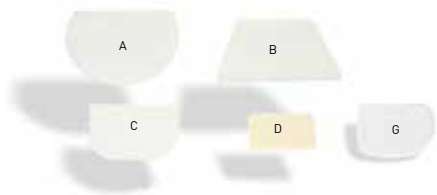

REF	mm	U
A P836.200	204 x 151	1
B P836.215	221 x 130	1
C P836.147	151 x 102	1
D P836.110	112 x 78	1
G P836.120	128 x 90	1

## P808 Peine decorador / Decorating comb / Peigne à decor / Dekorationskamm



REF	cm	U
P808.000	11 x 8	1

## P848 Marcador de tartas doble / Double cake divider / Séparateur de portions double / Doppelter Tortenschneider



REF	PORCIONES / PORTIONS / PORTIONEN	U
P848.008	8 / 12	1
P848.014	14 / 16	1

Polipropileno. Ø Total: 26,5 cm  
 Polypropylene.  
 Polypropylène.  
 Polypropylen.

## P8725 Rasqueta mango ABS / Scraper ABS handle / Raclette manche ABS / Schaber ABS Griff



REF	cm	U
P872.500	21 x 14,5	1

VER PRODUCTOS EN / SEE PRODUCTS ON /  
 VOIR PRODUITS EN / SIEHE PRODUKTE IN

UTENSILIOS / UTENSILS /  
 USTENSILES / ZUBEHÖR

P. 79





## P979 Soplete cocina / Pastry torch by gas / Torche à caraméliser / Küchengasbrenner

CE



Ref. 979.000

Llama super fuerte /  
Super strong flame /  
Flamme extra fort /  
Super starke Flamme

REF	cm	U
P979.100	10 x 13,6	1
P979.200	13 x 17,5	1
P979.000	16,5 x 21	1

Duración: 120 min.  
Length: 120 min.  
Durée: 120 min.  
Dauer: 120 min.

IDEA!



Ref. 979.100

Llama normal /  
Standar flame /  
Flamme normal /  
Normale Flamme



Ref. 979.200

Llama fuerte /  
Strong flame /  
Fort flamme /  
Starke Flamme

Quemador eléctrico redondo /  
Round electric caramelizer /  
Fer à caraméliser électrique rond /  
Elektrischer runder Brenner

## P991

CE



REF	Ø cm	L cm	W	U
P991.010	8	34	400	1

Tapa rectangular GN de policarbonato /  
GN polycarbonate rectangular lid /  
Couvercle rectangulaire GN en polycarbonate /  
Rechteckiger GN Deckel Polycarbonat

## P834



REF	mm	H mm	U
P834.000	530 x 325	100,0	1

Quemador eléctrico rectangular /  
Rectangular electric caramelizer /  
Fer à caraméliser électrique rectangulaire /  
Rechteckiger elektrischer Brenner

## P9911

CE



REF	cm	L cm	W	U
P991.108	24 x 8	49,5	1200	1
P991.112	24 x 12	49,5	2000	1

Campana GN de policarbonato /  
GN polycarbonate dome lid /  
Dôme de protection GN en polycarbonate /  
GN Haube Polycarbonat

## P835



REF	mm	H mm	U
P835.000	530 x 325	190,0	1



**P837** Expositor de tartas de aluminio / Aluminium cake stand /  
Présentoir de tartes en aluminium / Tortenständer aus Aluminium



REF	Ø cm	U
P837.003	20 / 26 / 32	1
P837.005	20 / 26 / 32 / 40 / 45	1
P837.007	16 / 20 / 26 / 32 / 40 / 45 / 50	1

**P8373** Expositor de tartas giratorio / Revolving cake stand /  
Présentoir giratoire de tartes / Drehbarer Tortenständer



REF	Ø cm	H cm	U
P837.300	30	8,00	1

**P350** Cedazos en acero inox / St/Steel sieves / Tamis en acier inox / Siebe aus rostfreiem Stahl

Detalle de las 6 mallas a escala real.  
Detail of the 6 sieves at real scale.  
Détail des 6 mailles à échelle réelle.  
Detail der 6 Maschen in realer Skala.

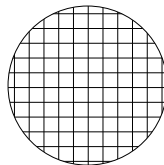

REF	Ø cm	Num	U
P350.230	30	10	6
P350.235	35	10	6

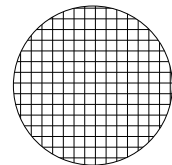

REF	Ø cm	Num	U
P350.330	30	14	6
P350.335	35	14	6

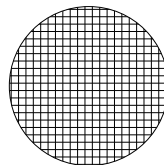

REF	Ø cm	Num	U
P350.426	26	20	6
P350.430	30	20	6
P350.435	35	20	6
P350.440	40	20	6

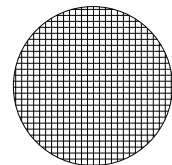

REF	Ø cm	Num	U
P350.526	26	25	6
P350.530	30	25	6
P350.535	35	25	6
P350.540	40	25	6

NUM.	LUZ DE MALLA / MESH SIZE / MAILLAGE / MASCHENWEITE (mm)
10	2,000
14	1,400
20	0,850
25	0,710
35	0,500
50	0,300

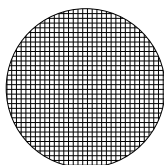

REF	Ø cm	Num	U
P350.626	26	35	6
P350.630	30	35	6
P350.635	35	35	6
P350.640	40	35	6

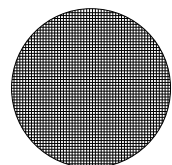

REF	Ø cm	Num	U
P350.726	26	50	6
P350.730	30	50	6
P350.735	35	50	6
P350.740	40	50	6

**P830** Embudo dosificador / Confectionery funnel / Entonnoir doseur / Dosierungstrichter

Ø 4 mm



830.001



830.002

REF	Lts	U
P830.001	1,00	1
P830.002	2,00	1

Boquilla recambio Ø 6 mm  
Spare tube Ø 6 mm  
Douille rechange Ø 6 mm  
Austauschbare Öffnung Ø 6 mm

**P970** Soporte para embudo o chino / Stand for funnel or chinese colander / Support pour entonnoir ou chinois / Ständer für Trichter oder Sieb

Ver / See / Voir / Siehe P. 91

**P830.003** Embudo dosificador económico / Economic confectionery funnel / Entonnoir doseur économique / Ökonomischer Dosierungstrichter

Ø 4 mm

REF	Lts	U
P830.003*	1,00	1
P830.004**		1

\*Boquilla de recambio Ø 6 mm.  
Spare tube Ø 6 mm.  
Douille de rechange Ø 6 mm.  
Austauschbare Öffnung Ø 6 mm.

\*\* Soporte embudo. Se vende por separado.  
Stand for funnel. Sell separately.  
Support pour entonnoir. Vendu séparément.  
Trichterständer. Separater Verkauf.

**P830.005** Embudo dosificador básico con soporte / Basic confectionery funnel with stand / Entonnoir doseur de base avec support / Basisdosierungstrichter mit Ständer

Ø 7,5 mm

REF	Lts	U
P830.005	1,00	1

Embudo y soporte se venden conjuntamente.  
Funnel and stand sold together.  
Entonnoir et support vendu ensemble.  
Trichter und Ständer werden zusammen verkauft.

**2800** Dispensador con control de porciones / Portion control dispenser /  
Distributeur contrôle de la partie / Portionskontrollspender



SAUCE BOSS®

REF	L	cm	H cm	U
2800-31	1,4	15,6 x 27,6	19,1	1



Obtenga un control de porciones preciso y uniforme.  
Get accurate and consistent portion control.  
Distribuez des portions précises et régulières.  
Für eine präzise und einheitliche Portionskontrolle.

Ajustes desde 15 hasta 0,9 ml.  
Settings from 15 to 0,9 ml.  
Doses réglables entre 15 et 0,9 ml.  
Von 15 bis 0,9 ml einstellbar.

**2803** Dispensador con control de porciones / Portion control dispenser /  
Distributeur contrôle de la partie / Portionskontrollspender



BATTER BOSS®

REF	L	cm	H cm	U
2803-18	1,4	15,6 x 27,6	19,1	1



Los ajustes de control de 8 porciones dispensan de 30 a 90 ml.  
8 portion control settings dispense from 30 to 90 ml.  
8 réglages de dose - 30 à 90 ml.  
8 portionskontrolleinstellungen zur ausgabe von 30-90 ml.

No se recomienda para batidos espesos.  
Not recommended for chunky batters.  
Non recommandé pour les pâtes grumeleuses.  
Nicht für bröselige teige empfohlen.

**P9095** Rejilla inox pastelería con pies / St/steel pastry grid with feet /  
Grille pâtisserie inox avec pieds / Patisserierost rostfreier Stahl mit Füßen

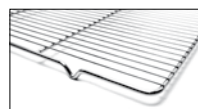

REF	mm	N. TRAVESAÑOS / N. CROSS-BARS / N. TRAVERSES / N. TRAVERSEN	Ø mm TRAVESAÑOS / Ø mm CROSS-BARS / Ø mm TRAVERSES / Ø mm TRAVERSEN	N. VARILLAS / N. WIRES / N. FILS / N. STÄBE	Ø mm VARILLAS / Ø mm WIRES / Ø mm FILS / Ø mm STÄBE	U
P909.559	590 x 390 x 20	3	5	29	2	1

VER PRODUCTOS EN / SEE PRODUCTS ON / VOIR PRODUITS EN / SIEHE PRODUKTE IN

**P318 / P1232 / P1321 / P9092 / P972 / P833**

BANDEJA PASTELERÍA / BAKING SHEET /  
PLAQUE À PÂTISSERIE / PATISSERIETABLETT



P. 54-55



P. 56



P. 58

**P7022**

Molde cake profesional /  
Professional cake mould /  
Cake embouti professionnel /  
Professionelle Backform



REF	cm (int.)	H cm	Lts	U
P702.230	30 x 10,5	8,0	2,0	1

**P702**

Molde cake /  
Cake mould /  
Cake embouti /  
Backform



REF	cm	H cm	U
P702.026	26 x 9,5	7,5	1
P702.028	28 x 10	7,5	1

**P704**

Molde para paté o cake desmontable /  
Folding cake mould /  
Pâté ou cake démontable /  
Backform für Pastete oder Kuchen demontierbar



REF	cm	H cm	U
P704.024	24 x 9,5	7,0	1
P704.030	30 x 10	7,5	1

**P709**

Molde fondo desmontable /  
Baking mould w/removable base /  
Tarte maison a/fond amovible /  
Backform Boden demontierbar



REF	cm	H cm	U
P709.035	35 x 11	2,5	1

**P707**

Placa madalenas pequeñas /  
Small madeleine sheet /  
Plaque madeleinettes /  
Backblech kleine Madeleine



REF	cm	U
P707.039	39,5 x 12,5	6

2 hileras de 10 madalenas pequeñas de 4,2 cm.  
2 rows of 10 small madeleines of 4,2 cm.  
2 rangées de 10 madeleinettes de 4,2 cm.  
2 Reihen von 10 kleinen Madeleinen von 4,2 cm.

**P706**

Placa madalenas /  
Madeleine sheet /  
Plaque madeleines /  
Backblech Madeleine



REF	cm	U
P706.039	39,5 x 20	6

2 hileras de 6 madalenas de 8 cm.  
2 rows of 6 madeleines of 8 cm.  
2 rangées de 6 madeleines de 8 cm.  
2 Reihen von 6 Madeleinen von 8 cm.



Molde desmontable Antiadherente /  
Non-stick spring form /  
Moule rond démontable /  
Demontierbare Backform Antihaft

**P723**



REF	Ø cm	H cm	U
P723.024	24	7,0	1
P723.028	28	7,0	1

Molde para tarta /  
High cake mould /  
Manqué rond uni /  
Tortenbackform

**P703**



REF	Ø cm	H cm	U
P703.020	20	4,5	1
P703.024	24	5,0	1
P703.028	28	5,0	1
P703.032	32	5,5	1

Molde rizado para tarta /  
Round tart mould with fluted edges /  
Tourtière ronde avec Bord cannelé /  
Runde Ecken Tortenbackform

**P710**



REF	Ø cm	H cm	U
P710.020	20	2,5	1
P710.024	24	2,5	1
P710.028	28	2,5	1
P710.032	32	2,5	1

Molde rizado fondo desmontable /  
Fluted edge mould with removable base /  
Tourtière avec fond amovible /  
Runde Ecken Backform Boden demontierbar

**P711**



REF	Ø cm	H cm	U
P711.010	10	1,8	1
P711.012	12	2,0	1
P711.020	20	2,5	6
P711.024	24	2,5	6
P711.028	28	2,5	6
P711.032	32	2,5	6

Flanero rizado 14 costados /  
14 Wide ribs brioche mould /

**P701** Brioche 14 côtes /  
Briochebackform mit 14 Rundungen



REF	Ø cm	H cm	Lts	U
P701.014	14	5,5	0,40	6
P701.016	16	6,5	0,55	6
P701.018	18	6,5	0,65	6
P701.020	20	8,3	1,00	6
P701.022	22	10,0	1,50	6

**P708** Molde savarin / Savarin mould /  
Moule savarin / Savarin Backform



REF	Ø cm	H cm	U
P708.008	8	2,0	1
P708.022	22	4,5	1
P708.024	24	5,0	1

Molde savarin "trois frères" /  
"Trois frères" ring mould /

**P712** Moule savarin "trois frères" /  
Savarin Backform "trois frères"



REF	Ø cm	H cm	U
P712.022	22	5,5	6

VER PRODUCTOS EN / SEE PRODUCTS ON /  
VOIR PRODUITS EN / SIEHE PRODUKTE IN

MAQUINARIA / MACHINERY /  
MACHINES / MASCHINEN



P. 254-255

**P715** Molde redondo para bizcocho / Baba mould /  
Baba rond / Baba Backform



REF	Ø cm	H cm	U
P715.006	6,5	6,0	6

Borde vuelto / Rolled edge /  
Bord roulé / Gerollter Rand

**P713** Molde ovalado para aspic / Oval aspic mould /  
Moule aspic ovale / Ovale Backform für Aspic



REF	cm	H cm	U
P713.075	7,5 x 5,5	3,8	6

**P718** Molde madalenas con 10 costados /  
10 Wide ribs brioche mould /  
Moule brioche 10 côtes /  
Madeleinenbackform 10 Rundungen



Ø 6: 9 costados. Resto ø: 10 costados / Ø 6: 9 ribs. Other ø: 10 ribs /  
Ø 6: 9 côtes. Autres ø: 10 côtes / Ø 6: 9 Rundungen. Resto ø: 10 Rundungen

REF	Ø cm	H cm	U
P718.006	6	2,5	6
P718.008	8	3,2	6
P718.010	10	3,8	6
P718.011	11	4,0	6

**P716** Molde barquita acanalada /  
Fluted oval boat mould /  
Moule barquette cannelée /  
Ovale Schiffchenbackform mit runden Ecken



REF	cm	H cm	U
P716.008	8 x 4	1,0	6
P716.010	10 x 4,5	1,0	6
P716.012	12 x 5	1,4	6

**P717** Molde barquita lisa / Plain oval boat mould /  
Moule Barquette unie / Glatte Schiffchenbackform



REF	cm	H cm	U
P717.008	8 x 3,3	1,2	6
P717.010	10 x 4,3	1,3	6

**P720** Molde tartaleta acanalada redonda /  
Round fluted tart mould /  
Moule tartelette ronde cannelée /  
Törtchenbackform mit runden Ecken



REF	Ø cm	H cm	U
P720.005	5	1,2	6
P720.006	6	1,2	6
P720.007	7	1,2	6
P720.008	8	1,2	6
P720.010	10	1,8	6
P720.012	12	2,0	6

**P721** Molde tartaleta redonda lisa /  
Round plain tart mould /  
Moule tartelette ronde unie /  
Glatte runde Törtchenbackform



REF	Ø cm	H cm	U
P721.005	5	1,2	6
P721.006	6	1,2	6
P721.007	7	1,2	6
P721.008	8	1,2	6
P721.010	10	1,2	6

VER PRODUCTOS EN / SEE PRODUCTS ON /  
VOIR PRODUITS EN / SIEHE PRODUKTE IN

JARRAS DE MEDIDAS / MEASURING JUGS /  
POTS MESUREURS / MESSBECHER



P. 123

**P722** Caja de 60 pequeños moldes "Petits fours" / 60 "Petits fours" moulds set /  
Boîte de 60 "petits fours" / Kisten mit 60 kleinen Backformen "Petits fours"



REF	U
P722.000	1

5 Piezas de cada uno de los 12 "Petits fours".  
5 Pieces of each 12 "Petits fours".  
5 Pièces de chacun des 12 "Petits fours".  
5 Teile von jeden 12 "Petits fours".



Caja de 8 cortapastas redondos lisos /  
Set of 8 round plain cutters /  
Boîte de 8 découpoirs ronds unis /  
**P732** Kiste mit 8 runden glatten Teigausstechformen

INOX - ST/STEEL  
ROSTFREIER STAHL



REF	Ø cm	H cm	U
P732.000	3 / 4 / 5 / 6 / 7 / 8 / 9 / 10	3,5	1

Caja de 8 cortapastas redondos rizados /  
Set of 8 round fluted cutters /  
Boîte de 8 découpoirs ronds cannelés /  
**P733** Kiste mit 8 Teigausstechformen mit runden Ecken

INOX - ST/STEEL  
ROSTFREIER STAHL



REF	Ø cm	H cm	U
P733.000	3 / 4 / 5 / 6 / 7 / 8 / 9 / 10	3,5	1

Caja 9 cortapastas redondos lisos poliglas /  
9 pcs set polyglass plain cutters /  
Boîte 9 découpoirs ronds unis polyglass /  
**P796** Kiste mit 9 runden glatten Teigausstechformen Polyglas



REF	Ø cm	H cm	U
P796.000	2 / 3 / 4 / 5 / 6 / 7 / 8 / 9 / 10	3,5	1

Caja 9 cortapastas redondos rizados poliglas /  
9 pcs set polyglass fluted cutters /  
Boîte 9 découpoirs ronds cannelés polyglass /  
**P7961** Kiste mit 9 Polyglas Teigausstechformen mit runden Ecken



REF	Ø cm	H cm	U
P796.100	2 / 3 / 4 / 5 / 6 / 7 / 8 / 9 / 10	3,5	1



**P780** Aro redondo para tarta / Tart ring / Cercle à tarte / Runder Tortenring



REF	Ø cm	H cm	U
P780.006	6	2,0	1
P780.008	8	2,0	1
P780.010	10	2,0	1
P780.020	20	2,0	1
P780.024	24	2,0	1
P780.028	28	2,0	1

**P781** Aro redondo para tarta / "Entremets" ring / Cercle à entremets / Runder Tortenring



REF	Ø cm	H cm	U
P781.006	6	3,5	1
P781.008	8	3,5	1
P781.010	10	3,5	1
P781.018	18	3,5	1
P781.020	20	3,5	1

**P785** Aro redondo para mousse / Mousse ring / Cercle à mousse / Runder Moussering



REF	Ø cm	H cm	U
P785.006	6	4,0	1
P785.008	8	4,0	1
P785.010	10	4,0	1
P785.012	12	4,0	1
P785.016	16	4,0	1
P785.020	20	4,0	1

**P782** Aro redondo para mousse / Mousse ring / Cercle à mousse / Runder Moussering



REF	Ø cm	H cm	U
P782.075	7,5	4,0	1
P782.008	8	4,5	1
P782.010	10	4,5	1
P782.012	12	4,5	1
P782.014	14	4,5	1
P782.016	16	4,5	1
P782.018	18	4,5	1
P782.020	20	4,5	1
P782.022	22	4,5	1
P782.024	24	4,5	1
P782.026	26	4,5	1
P782.028	28	4,5	1

**P783** Aro redondo para tarta / Ice cream cake ring / Cercle à vacherin / Runder Tortenring



REF	Ø cm	H cm	U
P783.006	6	6,0	1
P783.008	8	6,0	1
P783.010	10	6,0	1
P783.012	12	6,0	1
P783.014	14	6,0	1
P783.016	16	6,0	1
P783.018	18	6,0	1
P783.020	20	6,0	1
P783.022	22	6,0	1
P783.024	24	6,0	1
P783.026	26	6,0	1
P783.028	28	6,0	1
P783.030	30	6,0	1



Perfecto para presentación de platos /  
Perfect for dishes presentation /  
Idéal pour la présentation de plats /  
Perfekt für die Tellerpräsentation

MOLDES ACERO INOXIDABLE / ST/STEEL PASTRY MOULDS /  
MOULES EN ACIER INOX / BACKFORMEN ROSTFREIER STAHL

**P765** Molde hexagonal / Hexagon /  
Hexagone / Sechseckige Form

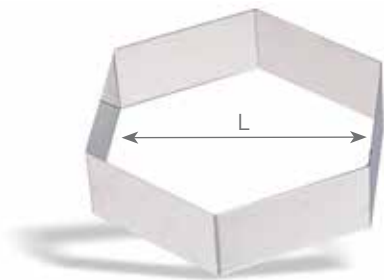

REF	L cm	H cm	U
P765.020	20	4,5	1
P765.022	22	4,5	1
P765.024	24	4,5	1

**P768** Molde forma lágrima / Tear /  
Larme / Tränenform

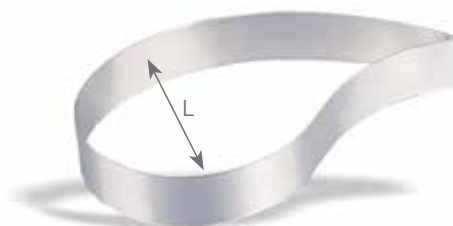

REF	L cm	H cm	U
P768.006	6	4,5	1
P768.008	8	4,5	1
P768.016	16	4,5	1

**P770** Molde forma gota / Drop / Goutte / Tropfenform



REF	L cm	H cm	U
P770.014	14	4,5	1

**P769** Molde forma corazón / Heart / Coeur / Herzform

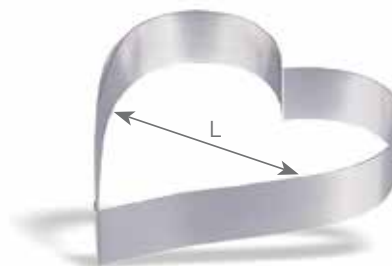

REF	L cm	H cm	U
P769.008	8	4,5	1
P769.010	10	4,5	1
P769.018	18	4,5	1
P769.020	20	4,5	1
P769.022	22	4,5	1

**P771** Molde forma oval / Oval / Ovale / Ovalform

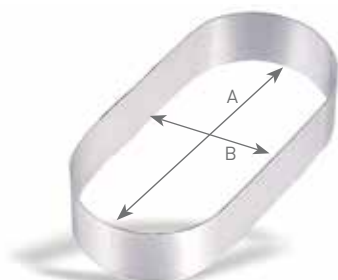

REF	L cm	H cm	U
P771.025	25 x 11,2	4,5	1

**P992** Cinta PVC para mousse / PVC ribbon for mousse /  
Ruban pâtissier en PVC / PVC Band für Mousse



REF	LONGITUD / LENGTH / LONGUEUR / LÄNGE	H cm	U
P992.040	100 m	4,0	1
P992.045	100 m	4,5	1
P992.050	100 m	5,0	1

MOLDES ACERO INOXIDABLE / ST/STEEL PASTRY MOULDS / MOULES EN ACIER INOX / BACKFORMEN ROSTFREIER STAHL

**P355** Flanero / Caramel cream mould /  
Moule à flan / Karamellcremeform

INOX - ST/STEEL  
ROSTFREIER STAHL



REF	Ø cm	H cm	Lts	U
P355.007	7,5	5,2	0,12	10
P355.008	8,5	5,4	0,17	10

**P3551** Flanero reforzado /  
Heavy duty caramel cream mould /  
Moule à flan renforcé /  
Verstärkte Karamellcremeform

INOX - ST/STEEL  
ROSTFREIER STAHL



REF	Ø cm	H cm	Lts	U
P355.107	7	5,5	0,14	1
P355.108	8	5,8	0,22	1

**P136** Molde industrial para flan /  
Reinforced caramel cream mould /  
Moule à flan /  
Industrielle Karamellcremeform

ALUMINIO /  
ALUMINIUM



REF	Ø cm	H cm	Lts	U
P136.006	6	5,5	0,10	1
P136.007	7	6,5	0,15	1
P136.008	8	6,5	0,25	1

**P784** Molde cake / Cake mould /  
Moule à cake / Kuchenbackform



REF	cm	U
P784.020	20 x 13 x 8	1
P784.025	25 x 13 x 8	1
P784.030	30 x 13 x 8	1
P784.035	35 x 13 x 8	1
P784.040	40 x 13 x 8	1

**P764** Molde semiesférico / Hemispherical mould /  
Demi-sphérique / Halbkugelform



REF	Ø cm	H cm	Lts	U
P764.004	4	2,0	0,015	1
P764.006	6	3,0	0,050	1
P764.008	8	4,0	0,130	1
P764.010	10	5,0	0,260	1
P764.012	12	6,2	0,450	1
P764.014	14	6,7	0,700	1

Molde 1/2 caña desmontable triangular /  
Triangle cake mould /  
Gouttière triangulaire /  
**P788** Dreieckige demontierbare Backform



REF	cm	U
P788.025	25 x 9 x 6	1
P788.050	50 x 9 x 6	1

**P789** Molde 1/2 caña desmontable redondo / Round cake mould / Gouttière ronde / Halbrunde demontierbare Backform



REF	cm	U
P789.025	25 x 9 x 6	1
P789.050	50,5 x 9 x 9	1





**P826** Juego pistola repostería / Cooking press cum icing set / Pistolet pour pâtisserie / Spritztüllenset



REF	mm	U
P826.000	220 x 60	1

**P798** Mangas desechables / Disposable pastry bags / Poches jetables / Einweg Spritzbeutel



REF	cm	Lts	U
P798.040	43	2,00	1
P798.055	55	3,50	1
P798.065	65	5,00	1

Caja de 100 unidades / 100 pieces set / Boîte de 100 pièces / Kiste von 100 Stück.

**P849** Soporte para mangas pasteleras y boquillas / Support for pastry bags and tubes (nozzles) / Support pour pochés pâtisseries et douilles / Ständer für Spritzbeutel und Tüllen



REF	U
P849.000	1

**P851** Manga pastelera de algodón / Cotton pastry bag / Poches pâtisseries en cotton / Baumwolle Spritzbeutel



REF	L cm	U
P851.040	40	1
P851.046	46	1
P851.050	50	1
P851.060	60	1

**P800** Mangas de nylon / Nylon pastry bags / Poches pâtisseries en nylon / Nylon Spritzbeutel



REF	cm	U
P800.030	30	6
P800.035	35	6
P800.040	40	6
P800.045	45	6
P800.050	50	6
P800.055	55	6
P800.060	60	6
P800.065	65	6
P800.070	70	6

Fabricadas en nylon y recubiertas de poliuretano por una cara. Impermeables y ultraligeras. Son muy cómodas de utilizar. Se pueden hervir. Sin costuras, termosoldadas de larga duración y con la punta ajustable /

Made in nylon and covered with polyurethane on one side. Waterproof, ultra light and very comfortable to use. Sterizable, without seams, thermowelded for long life and with an adjustable end /

Fabriquées en tissu de nylon avec un revêtement polyuréthane sur une face. Impérmeables, très souples, ultralégères et très comodes au tact. Stérilisables, sans coutures, thermosoudées, de longue durée et avec l'embout ajustable /

Hergestellt aus Nylon und auf einer Seite mit Polyurethan beschichtet. Undurchlässig und ultraleicht. Sie sind sehr einfach zu benutzen. Sie lassen sich abkochen. Ohne Nähte, langlebige Hitzeverschweißung mit einer anpassbaren Spitze

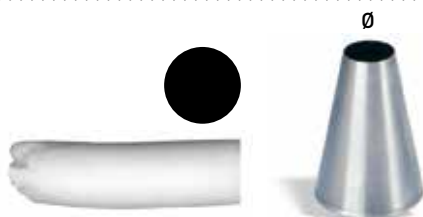
**P810** Boquilla redonda / Plain tube / Douille unie / Rundtülle

REF	Ø mm	U
P810.002	2	25
P810.004	4	25
P810.006	6	25
P810.008	8	25
P810.010	10	25
P810.012	12	25
P810.014	14	25
P810.016	16	25

**P811** Boquilla estrella / Star tube / Douille cannelée / Sterntülle

REF	Ø mm	Nº PUNTAS / Nº TEETH / Nº DENTS / Nº ECKEN	U
P811.002	2	6	25
P811.004	4	6	25
P811.006	6	6	25
P811.008	8	6	25
P811.010	10	7	25
P811.012	12	7	25
P811.014	14	8	25
P811.016	16	9	25
P811.018	18	10	25

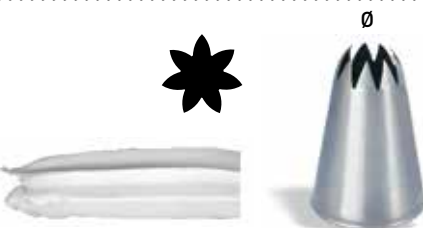
**P812** Boquilla estrella cerrada / Closed star tube / Douille cannelée fermée / Geschlossene Sterntülle

REF	Ø mm	Nº PUNTAS / Nº TEETH / Nº DENTS / Nº ECKEN	U
P812.003	3	6	25
P812.005	5	6	25
P812.007	7	6	25
P812.009	9	8	25
P812.011	11	8	25

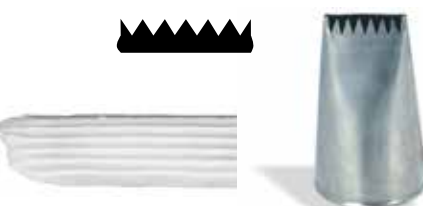
**P813** Boquilla cinta estrella / Yule log tube / Douille à bûche de Noël / Sternbandtülle

REF	mm	Nº PUNTAS / Nº TEETH / Nº DENTS / Nº ECKEN	U
P813.016	16 x 2	6	25
P813.020	20 x 3	6	25
P813.028	28 x 4	6	25

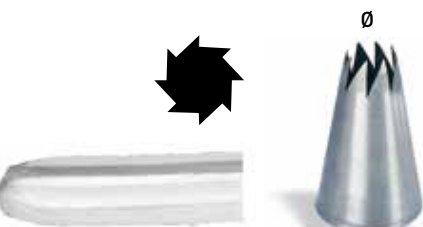
**P816** Boquilla flor / Flower tube / Douille fleur / Blumentülle

REF	Ø mm	Nº PUNTAS / Nº TEETH / Nº DENTS / Nº ECKEN	U
P816.011	11	6	25
P816.013	13	8	25
P816.015	15	9	25

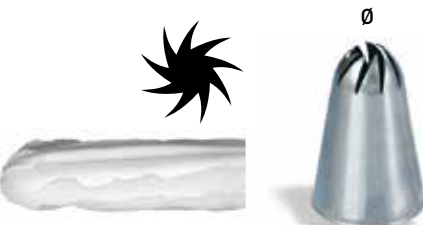
**P817** Boquilla flor cerrada / Closed flower tube / Douille fleur fermée / Geschlossene Blumentülle

REF	Ø mm	Nº PUNTAS / Nº TEETH / Nº DENTS / Nº ECKEN	U
P817.005	5	6	25
P817.006	6	8	25
P817.008	8	9	25

**P815** Boquilla rizada / "petits fours" tube / Douille à "petits fours" / Tülle "petits fours"



REF	Ø mm	Nº PUNTAS / Nº TEETH / Nº DENTS / Nº ECKEN	U
P815.004	4	9	25
P815.006	6	9	25
P815.009	9	12	25
P815.012	12	15	25
P815.015	15	16	25
P815.018	18	18	25

**P814** Boquilla para relleno / Bismark tube / Douille petit chou / Fülltülle



REF	Ø mm	U
P814.000	4	25

**P820** Conjunto de 6 boquillas nº 0 / Set of 6 tubes nr. 0 / Boîte de 6 douilles num. 0 / Set von 6 Tüllen Nr. 0





REF	U
P820.000	1

Los gráficos de los diámetros de los agujeros de salida de las boquillas son a tamaño real / Diameter exit holes of the tubes are drawn at real size.  
Les graphiques des diamètres des embouts de sortie des douilles sont en taille réelle / Der abgebildete Durchmesser der Öffnungen entspricht der realen Grösse.

- 

1 Boquilla redonda 4 mm  
1 Plain tube 4 mm  
1 Douille unie 4 mm  
1 Rundtülle 4 mm
- 

1 Boquilla cinta estrella 20 x 3 mm  
1 Yule log 20 x 3 mm  
1 Douille à bûche de Noël 20 x 3 mm  
1 Sternbandtülle 20 x 3mm
- 

1 Boquilla estrella 12 mm  
1 Star tube 12 mm  
1 Douille cannelée 12 mm  
1 Sterntülle 12 mm
- 

1 Boquilla estrella 8 mm  
1 Star tube 8 mm  
1 Douille cannelée 8 mm  
1 Sterntülle 8 mm
- 

1 Boquilla redonda 8 mm  
1 Plain tube 8 mm  
1 Douille unie 8 mm  
1 Rundtülle 8 mm
- 

1 Boquilla flor 11 mm  
1 Flower tube 11 mm  
1 Douille fleur 11 mm  
1 Blumentülle 11 mm

**P821** Conjunto de 6 boquillas nº 1 / Set of 6 tubes nr. 1 / Boîte de 6 douilles num. 1 / Set von 6 Tüllen Nr. 1





REF	U
P821.000	1

Los gráficos de los diámetros de los agujeros de salida de las boquillas son a tamaño real / Diameter exit holes of the tubes are drawn at real size.  
Les graphiques des diamètres des embouts de sortie des douilles sont en taille réelle / Der abgebildete Durchmesser der Öffnungen entspricht der realen Grösse.

- 

1 Boquilla redonda 2 mm  
1 Plain tube 2 mm  
1 Douille unie 2 mm  
1 Rundtülle 2 mm
- 

1 Boquilla redonda 6 mm  
1 Plain tube 6 mm  
1 Douille unie 6 mm  
1 Rundtülle 6 mm
- 

1 Boquilla redonda 10 mm  
1 Plain tube 10 mm  
1 Douille unie 10 mm  
1 Rundtülle 10 mm
- 

1 Boquilla redonda 4 mm  
1 Plain tube 4 mm  
1 Douille unie 4 mm  
1 Rundtülle 4 mm
- 

1 Boquilla redonda 8 mm  
1 Plain tube 8 mm  
1 Douille unie 8 mm  
1 Rundtülle 8 mm
- 

1 Boquilla redonda 12 mm  
1 Plain tube 12 mm  
1 Douille unie 12 mm  
1 Rundtülle 12 mm

### P822 Conjunto de 6 boquillas nº 2 / Set of 6 tubes nr. 2 / Boîte de 6 douilles num. 2 / Set von 6 Tüllen Nr. 2



REF	U
P822.000	1

Los gráficos de los diámetros de los agujeros de salida de las boquillas son a tamaño real / Diameter exit holes of the tubes are drawn at real size  
Les graphiques des diamètres des embouts de sortie des douilles sont en taille réelle / Der abgebildete Durchmesser der Öffnungen entspricht der realen Größe.

<ul style="list-style-type: none"> <li>1 Boquilla estrella 2 mm</li> <li>1 Star tube 2 mm</li> <li>1 Douille cannelée 2 mm</li> <li>1 Sterntülle 2 mm</li> </ul>	<ul style="list-style-type: none"> <li>1 Boquilla estrella 6 mm</li> <li>1 Star tube 6 mm</li> <li>1 Douille cannelée 6 mm</li> <li>1 Sterntülle 6 mm</li> </ul>	<ul style="list-style-type: none"> <li>1 Boquilla estrella 10 mm</li> <li>1 Star tube 10 mm</li> <li>1 Douille cannelée 10 mm</li> <li>1 Sterntülle 10 mm</li> </ul>
<ul style="list-style-type: none"> <li>1 Boquilla estrella 4 mm</li> <li>1 Star tube 4 mm</li> <li>1 Douille cannelée 4 mm</li> <li>1 Sterntülle 4 mm</li> </ul>	<ul style="list-style-type: none"> <li>1 Boquilla estrella 8 mm</li> <li>1 Star tube 8 mm</li> <li>1 Douille cannelée 8 mm</li> <li>1 Sterntülle 8 mm</li> </ul>	<ul style="list-style-type: none"> <li>1 Boquilla estrella 12 mm</li> <li>1 Star tube 12 mm</li> <li>1 Douille cannelée 12 mm</li> <li>1 Sterntülle 12 mm</li> </ul>

### P823 Conjunto de 6 boquillas nº 3 / Set of 6 tubes nr. 3 / Boîte de 6 douilles num. 3 / Set von 6 Tüllen Nr. 3



REF	U
P823.000	1

Los gráficos de los diámetros de los agujeros de salida de las boquillas son a tamaño real / Diameter exit holes of the tubes are drawn at real size  
Les graphiques des diamètres des embouts de sortie des douilles sont en taille réelle / Der abgebildete Durchmesser der Öffnungen entspricht der realen Größe.

<ul style="list-style-type: none"> <li>1 Boquilla rizada 12 mm</li> <li>1 "Petits fours" tube 12 mm</li> <li>1 Douille à "petits fours" 12 mm</li> <li>1 Tülle "petits fours" 12 mm</li> </ul>	<ul style="list-style-type: none"> <li>1 Boquilla estrella cerrada 7 mm</li> <li>1 Closed star tube 7 mm</li> <li>1 Douille cannelée fermée 7 mm</li> <li>1 Geschlossene Sterntülle 7 mm</li> </ul>	<ul style="list-style-type: none"> <li>1 Boquilla estrella 8 mm</li> <li>1 Star tube 8 mm</li> <li>1 Douille cannelée 8 mm</li> <li>1 Sterntülle 8 mm</li> </ul>
<ul style="list-style-type: none"> <li>1 Boquilla flor 13 mm</li> <li>1 Flower tube 13 mm</li> <li>1 Douille fleur 13 mm</li> <li>1 Blumentülle 13 mm</li> </ul>	<ul style="list-style-type: none"> <li>1 Boquilla flor cerrada 6 mm</li> <li>1 Closed flower tube 6 mm</li> <li>1 Douille fleur fermée 6 mm</li> <li>1 Geschlossene Blumentülle 6 mm</li> </ul>	<ul style="list-style-type: none"> <li>1 Boquilla redonda 10 mm</li> <li>1 Plain tube 10 mm</li> <li>1 Douille unie 10 mm</li> <li>1 Rundtülle 10 mm</li> </ul>

### P824 Conjunto de 12 boquillas nº 4 / Set of 12 tubes nr. 4 / Boîte de 12 douilles num. 4 / Set von 12 Tüllen Nr. 4



REF	U
P824.000	1

Los gráficos de los diámetros de los agujeros de salida de las boquillas son a tamaño real / Diameter exit holes of the tubes are drawn at real size  
Les graphiques des diamètres des embouts de sortie des douilles sont en taille réelle / Der abgebildete Durchmesser der Öffnungen entspricht der realen Größe.

<ul style="list-style-type: none"> <li>1 Boquilla redonda 6 mm</li> <li>1 Plain tube 6 mm</li> <li>1 Douille unie 6 mm</li> <li>1 Rundtülle 6 mm</li> </ul>	<ul style="list-style-type: none"> <li>1 Boquilla estrella cerrada 7 mm</li> <li>1 Closed star tube 7 mm</li> <li>1 Douille cannelée fermée 7 mm</li> <li>1 Geschlossene Sterntülle 7 mm</li> </ul>	<ul style="list-style-type: none"> <li>1 Boquilla rizada 15 mm</li> <li>1 "Petits fours" tube 15 mm</li> <li>1 Douille à "petits fours" 15 mm</li> <li>1 Tülle "petits fours" 15 mm</li> </ul>
<ul style="list-style-type: none"> <li>1 Boquilla redonda 10 mm</li> <li>1 Plain tube 10 mm</li> <li>1 Douille unie 10 mm</li> <li>1 Rundtülle 10 mm</li> </ul>	<ul style="list-style-type: none"> <li>1 Boquilla estrella cerrada 11 mm</li> <li>1 Closed star tube 11 mm</li> <li>1 Douille cannelée fermée 11 mm</li> <li>1 Geschlossene Sterntülle 11 mm</li> </ul>	<ul style="list-style-type: none"> <li>1 Boquilla flor 11 mm</li> <li>1 Flower tube 11 mm</li> <li>1 Douille fleur 11 mm</li> <li>1 Blumentülle 11 mm</li> </ul>
<ul style="list-style-type: none"> <li>1 Boquilla estrella 8 mm</li> <li>1 Star tube 8 mm</li> <li>1 Douille cannelée 8 mm</li> <li>1 Sterntülle 8 mm</li> </ul>	<ul style="list-style-type: none"> <li>1 Boquilla cinta estrella 20 mm</li> <li>1 Yule log tube 20 mm</li> <li>1 Douille à bûche de Noël 20 mm</li> <li>1 Sternbandtülle 20 mm</li> </ul>	<ul style="list-style-type: none"> <li>1 Boquilla flor 15 mm</li> <li>1 Flower tube 15 mm</li> <li>1 Douille fleur 15 mm</li> <li>1 Blumentülle 15 mm</li> </ul>
<ul style="list-style-type: none"> <li>1 Boquilla estrella 12 mm</li> <li>1 Star tube 12 mm</li> <li>1 Douille cannelée 12 mm</li> <li>1 Sterntülle 12 mm</li> </ul>	<ul style="list-style-type: none"> <li>1 Boquilla rizada 9 mm</li> <li>1 "Petits fours" tube 9 mm</li> <li>1 Douille à "petits fours" 9 mm</li> <li>1 Tülle "petits fours" 9 mm</li> </ul>	<ul style="list-style-type: none"> <li>1 Boquilla flor cerrada 8 mm</li> <li>1 Closed flower tube 8 mm</li> <li>1 Douille fleur fermée 8 mm</li> <li>1 Geschlossene Blumentülle 8 mm</li> </ul>



**P853** Boquilla redonda de policarbonato / Polycarbonate plain tube /  
 Douille unie en polycarbonate / Rundtülle Polycarbonat



REF	Ø mm	Num.	U
P853.004	4	0	1
P853.006	6	2	1
P853.008	8	4	1
P853.010	10	6	1
P853.012	12	8	1
P853.014	14	10	1
P853.016	16	12	1

**P854** Boquilla estrella de policarbonato / Polycarbonate star tube /  
 Douille cannelée en polycarbonate / Sterntülle Polycarbonat



REF	Ø mm	Nº PUNTAS / Nº TEETH / Nº DENTS / Nº ZACKEN	Num.	U
P854.006	6	7	2	1
P854.008	8	7	4	1
P854.010	10	7	6	1
P854.012	12	7	8	1
P854.014	14	8	10	1
P854.016	16	8	12	1

**P855** Conjunto de 6 boquillas de policarbonato nº 5 / Set of 6 polycarbonate tubes nº 5 /  
 Boîte de 6 douilles en polycarbonate nº 5 / Set von 6 Tüllen Polycarbonat Nr. 5

Boquilla redonda  
 Plain tube  
 Douille unie  
 Rundtülle



REF	U
P855.000	1

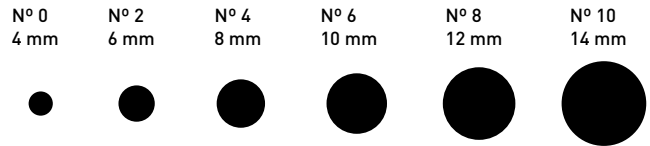

**P856** Conjunto de 6 boquillas de policarbonato nº 6 / Set of 6 polycarbonate tubes nº 6 /  
 Boîte de 6 douilles en polycarbonate nº 6 / Set von 6 Tüllen Polycarbonat Nr. 6

Boquilla estrella  
 Star tube  
 Douille cannelée  
 Sterntülle



REF	U
P856.000	1

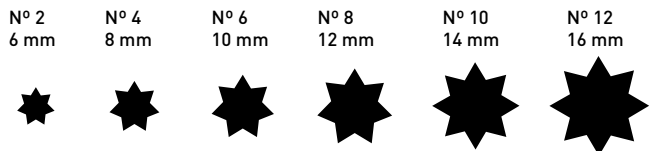

**P857** Conjunto de 12 boquillas de policarbonato nº 12 / Set of 12 polycarbonate tubes nº 12 /  
 Boîte de 12 douilles en polycarbonate nº 12 / Set von 12 Tüllen Polycarbonat Nr. 12

Boquilla redonda  
 Plain tube  
 Douille unie  
 Rundtülle



REF	U
P857.000	1

Boquilla estrella  
 Star tube  
 Douille cannelée  
 Sterntülle

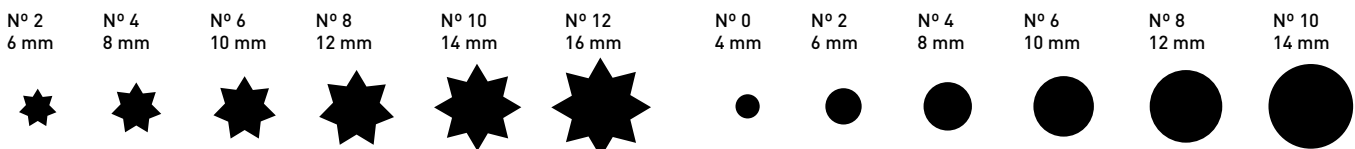

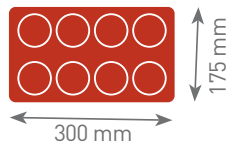

**MEDIDAS /  
SIZES /  
MESURES /  
GRÖSSEN**

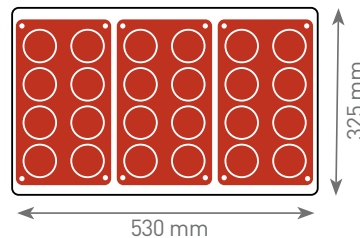
Gastronorm

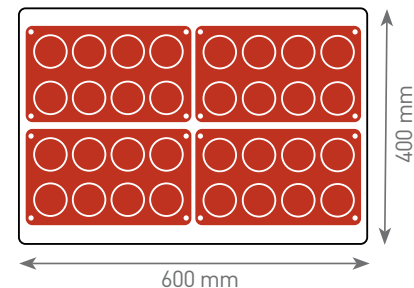

Pastelería / Pastry / Pâtisserie / Pâtisserie



ESPAÑOL

**CARACTERÍSTICAS TÉCNICAS**

FABRICADO EN SILICONA 100% APTA PARA USO ALIMENTARIO SEGÚN LAS NORMAS INTERNACIONALES HACCP. ESTOS MOLDES SON ANTIADHERENTES POR LO QUE NO ES NECESARIO ENGRASARLOS ANTES. SU FLEXIBILIDAD PERMITE UN RÁPIDO Y FÁCIL DESMOLDE. FÁCIL DE LIMPIAR CON SOLO AGUA CALIENTE Y UNA SUAVE ESPONJA O EN EL LAVAVAJILLAS. MÍNIMO MANTENIMIENTO, MÁXIMA RESISTENCIA Y LARGA DURACIÓN.

**UTILIZACIÓN**

RESISTENTE A TEMPERATURAS DE -60 °C A +230 °C. IDEAL PARA CONGELADOR Y HORNO. PUEDE SER UTILIZADO PARA PREPARAR TODO TIPO DE PEQUEÑA REPOSTERÍA, GALLETAS O CHOCOLATES.

ENGLISH

**TECHNICAL SPECIFICATIONS**

MANUFACTURED IN PLAIN 100% SILICONE. THE MOULDS ARE SUITABLE FOR FOOD CONTACT AS PER INTERNATIONAL REGULATIONS H.A.C.C.P. THE SURFACE IS NON-STICK SO IT IS NOT NECESSARY TO GREASE IT BEFORE USE. THE FLEXIBILITY OF THE MOULDS GUARANTEES A QUICK AND EASY REMOVAL. THE MOULDS ARE EASY TO CLEAN WITH HOT WATER AND SOFT SPONGE. SAFE DISHWASHER. MINIMUM MAINTENANCE, LONG DURABILITY AND MAXIMUM RESISTANCE.

**UTILISATION**

THE RESISTANCE OF THE MOULDS TO EXTREME TEMPERATURES FROM -60 °C TO +230 °C MAKES THEM IDEAL FOR FREEZING OR FOR BAKING. IT CAN ALSO BE USED FOR ALL PREPARATIONS OF CAKES, CHOCOLATES, PETIT-FOURS, AND CATERING PREPARATIONS.

FRANÇAIS

**CARACTERISTIQUES TECHNIQUES**

FABRICATION 100% SILICONE ALIMENTAIRE. CES MOULES SONT CONFORMES AU CONTACT ALIMENTAIRE SELON LES NORMES INTERNATIONALES H.A.C.C.P. CES MOULES SONT ANTI-ADHÉSIFS ET NE NÉCESSITENT PAS DE GRAISSAGE AVANT UTILISATION. LA FLEXIBILITÉ DES MOULES GARANTIT UN RAPIDE ET FACILE DEMOULAGE. LAVABLE EN MACHINE À L'AVER OU AVEC UNE ÉPONGE À L'EAU. MINIMUM D'ENTRETIEN, LONGUE DURABILITÉ ET MAXIMUM DE RESISTANCE.

**UTILISATION**

RÉSISTANT À DES TEMPÉRATURES DE -60 °C À +230 °C. IDÉAL POUR LA CONGÉLATION OU CUISSONS AU FOUR. UTILISABLE POUR TOUT TYPE DE PRÉPARATIONS DE CAKES, CHOCOLATS, PETITS FOURS, ET PRÉPARATIONS TRAITEURS.

DEUTSCH

**TECHNISCHE EIGENSCHAFTEN**

HERGESTELLT AUS 100% SILIKON GEEIGNET FÜR DIE LEBENSMITTELVERARBEITUNG ENTSPRECHEND DER INTERNATIONALEN NORMEN HACCP. DIESE FORMEN SIND ANTIHAFTEND UND MAN BENÖTIGT KEIN VORHERIGES EINFETTEN. SEINE FLEXIBILITÄT ERLAUBT EINE EINFACHE UND SCHNELLE ABLÖSUNG VON DER FORM. EINFACHE REINIGUNG NUR MIT WARMEN WASSER UND EINEM WEICHEN SCHWAMM ODER IN DER SPÜLMASCHINE. MINIMALE INSTANDHALTUNG, MAXIMALE RESISTENZ UND LANGLEBIGKEIT.

**GEBRAUCH**

RESISTENT GEGEN TEMPERATUREN VON -60 °C BIS +230 °C. IDEAL FÜR DEN GEFRIERSCHRANK UND DEN OFEN. SIE SIND GEEIGNET FÜR ALLE ARTEN DER ZUBEREITUNG VON KLEINEN NACHSPEISEN, KEKSEN ODER SCHOKOLADEN.

● -60 °C / - 140 °F  
● +230 °C / + 446 °F



H.A.C.C.P.  
NO PROBLEM

MEDIA BOLA

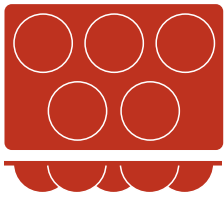

REF	Fig	Ø mm	H mm
P850.001	5	80	40

MEDIA BOLA

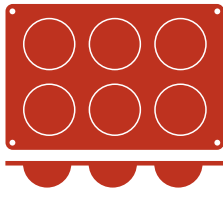

REF	Fig	Ø mm	H mm
P850.002	6	70	35

MEDIA BOLA

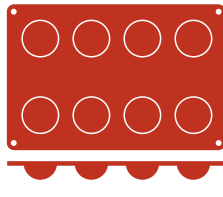

REF	Fig	Ø mm	H mm
P850.003	8	60	30

MEDIA BOLA

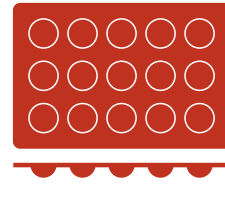

REF	Fig	Ø mm	H mm
P850.004	15	50	25

MEDIA BOLA

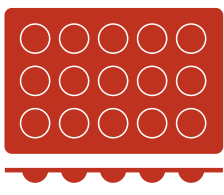

REF	Fig	Ø mm	H mm
P850.005	15	40	20

MEDIA BOLA

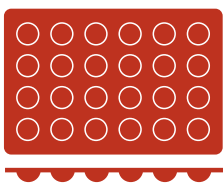

REF	Fig	Ø mm	H mm
P850.006	24	30	15

PIRAMIDE

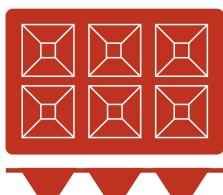

REF	Fig	mm	H mm
P850.007	6	71 x 71	40

MINI-SAVARIN

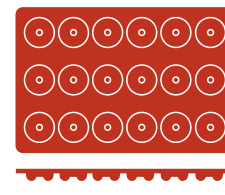

REF	Fig	Ø mm	H mm
P850.010	18	41	12

SAVARIN

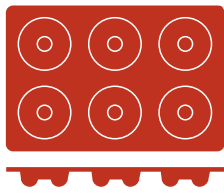

REF	Fig	Ø mm	H mm
P850.012	6	72	23

OVAL

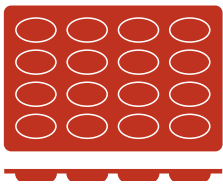

REF	Fig	mm	H mm
P850.017	16	53 x 33	20

OVAL

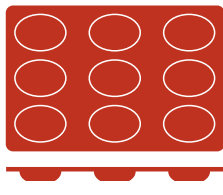

REF	Fig	mm	H mm
P850.018	9	70 x 50	20

MUFFIN

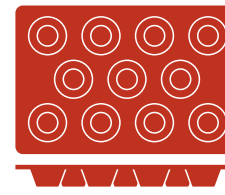

REF	Fig	Ø mm	H mm
P850.022	11	50	28

MUFFIN

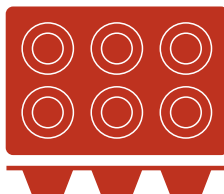

REF	Fig	Ø mm	H mm
P850.023	6	70	37

MUFFIN

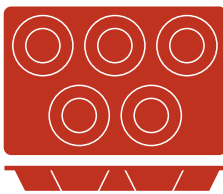

REF	Fig	Ø mm	H mm
P850.024	5	80	35

CAKE

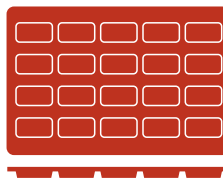

REF	Fig	mm	H mm
P850.025	20	49 x 26	11

CAKE

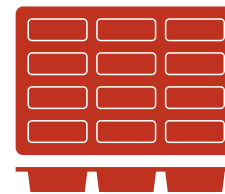

REF	Fig	mm	H mm
P850.026	12	80 x 30	30

PETIT FOUR

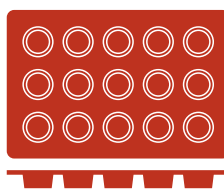

REF	Fig	Ø mm	H mm
P850.027	15	40	20

CILINDRO

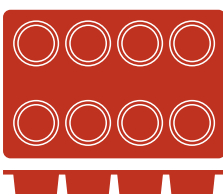

REF	Fig	Ø mm	H mm
P850.028	8	60	35

FLORENTINO

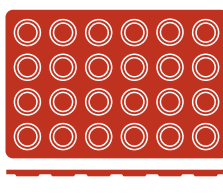

REF	Fig	Ø mm	H mm
P850.030	24	35	5

MADALENA

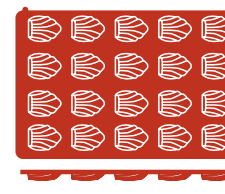

REF	Fig	mm	H mm
P850.031	20	38 x 30	10

MADALENA



REF	Fig	mm	H
			mm
P850.032	9	78 x 45	17

BORDELAIS

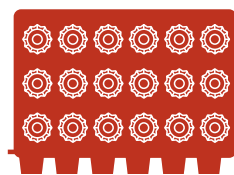

REF	Fig	Ø	H
		mm	mm
P850.033	18	35	35

BRIOCHE

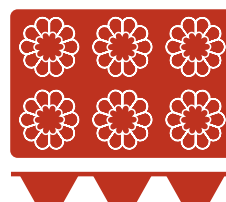

REF	Fig	Ø	H
		mm	mm
P850.034	6	79	37

CORAZON

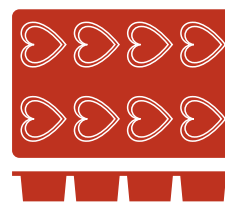

REF	Fig	mm	H
			mm
P850.037	8	65 x 60	35





**P8504** Molde cake / Cake mould / Moule à cake / Kuchenbackform



REF	cm	U
P850.424	24 x 10,5 x 6,5	1
P850.426	26 x 10 x 7	1

**P8501** Molde tarta / High cake mould / Manqué rond uni / Tortenbackform



REF	Ø cm	H cm	U
P850.124	24	4,2	1
P850.128	28	4,7	1

**P8502** Molde savarin alto / Gugelhoph / Moule savarin haut / Hohe Savarinbackform



REF	Ø cm	H cm	U
P850.222	22,5	11,5	1

Nueva forma  
New shape  
Nouvelle forme  
Neue Form

**P8505** Molde rizado para tarta / Round tart mould with fluted edges /  
Tourtière ronde avec bord cannelé / Tortenbackform mit runden Ecken



REF	Ø cm	H cm	U
P850.528	28	3,0	1

Nueva forma  
New shape  
Nouvelle forme  
Neue Form

**P8506** Flanero rizado / Brioche mould / Moule à brioche / Briochebackform



REF	Ø cm	H cm	U
P850.614	14	5,0	1

## MOLDES SILICONA / SILICONE MOULDS / MOULES SILICONE / SILIKONBACKFORMEN

Moldes de silicona 600 x 400 mm Ofrecen la posibilidad de dividirlos en 2 moldes de 300 x 200 mm gracias a su diseño simétrico / Silicone moulds 600 x 400 mm. Possible to divide in two of 300 x 200 mm thanks to its symmetrical design / Moules en silicone 600 x 400 mm avec possibilité de diviser en deux moules de 300 x 200 mm grâce à sa symétrie / Silikonformen 600 x 400 mm. Dank seinem symetrischen Design können sie in zwei Formen von 300 x 200 mm geteilt werden.

### P859900 Mini-cakes / Mini-cakes / Mini-cakes / Minikuchen



600 x 400 mm

REF	Fig	mm	H mm	U
P859.900	20	100 x 50	30	1

### P859901 Briochette



600 x 400 mm

REF	Fig	Ø mm	H mm	U
P859.901	24	79	37	1

### P859902 Semi-esferas / Half-spheres / Demi-sphères / Halbkugeln



600 x 400 mm

REF	Fig	Ø mm	H mm	U
P859.902	24	70	35	1

### P859903 Muffin



600 x 400 mm

REF	Fig	Ø mm	H mm	U
P859.903	24	70	42	1

### P859904 Mini muffin



600 x 400 mm

REF	Fig	Ø mm	H mm	U
P859.904	70	50	28	1

### P859905 Gugelhopf



600 x 400 mm

REF	Fig	Ø mm	H mm	U
P859.905	24	70	36	1

**P859906** Savarin



600 x 400 mm

REF	Fig	Ø mm	H mm	U
P859.906	24	72	23	1

**P859907** Mini madalenas / Mini madeleines /  
Mini madeleines / Minimadeleines



600 x 400 mm

REF	Fig	mm	H mm	U
P859.907	84	42 x 30	11	1

**P859908** Tartaletas / Tartalets /  
Tartalettes / Törtchen



600 x 400 mm

REF	Fig	Ø mm	H mm	U
P859.908	60	50	15	1

**P859909** Canalados / Cannelés



600 x 400 mm

REF	Fig	Ø mm	H mm	U
P859.909	60	85	50	1

**P859910** Piramides / Pyramids /  
Pyramides / Pyramiden



600 x 400 mm

REF	Fig	mm	H mm	U
P859.910	30	71 x 71	40	1

**P859911** Florentinas / Florentiners /  
Florentins / Florentiner



600 x 400 mm

REF	Fig	Ø mm	H mm	U
P859.911	40	35	12	1

## MOLDES FLEXIPAN / FLEXIPAN MOULDS / MOULES FLÉXIPAN / FLEXIPANFORMEN

**FLEXIPAN®**

ESPAÑOL

EL FLEXIPAN® ES UNA COMBINACIÓN DE FIBRAS DE VIDRIO Y SILICONA ADECUADAS PARA EL USO ALIMENTARIO. ESTA COMBINACION DE MATERIALES LE DA A LA PIEZA UNA SOLIDEZ Y DURACIÓN DE VIDA INIGUALABLES, ASI COMO PROPIEDADES ANTI-ADHERENTES EXCEPCIONALES TANTO EN COCCIÓN COMO EN CONGELACIÓN. EL FLEXIPAN® NO REQUIERE SER ENGRASADO YA QUE SU COMPOSICIÓN Y FLEXIBILIDAD PERMITEN UN DESMOLDEO FÁCIL Y RÁPIDO. EL FLEXIPAN® CON UN USO Y TRATO CORRECTOS NOS PERMITE REALIZAR ENTRE 2.000 Y 3.000 COCCIONES ANTES DE EMPEZAR A NOTAR LOS PRIMEROS SIGNOS DE DETERIORO. EL FLEXIPAN® PERMITE REALIZAR CUALQUIER TIPO DE PREPARACIONES DULCES O SALADAS, TANTO EN COCCIÓN (+280°C) COMO EN CONGELACIÓN (-40°C).

## VENTAJAS FLEXIPAN®

- NO ES NECESARIO ENGRASAR LOS MOLDES PARA OBTENER UN DESMOLDEO PERFECTO
- GRAN FACILIDAD PARA EL DESMOLDEO DE PIEZAS CONGELADAS
- LA LIMPIEZA DE LOS MOLDES SE REALIZA DE UNA MANERA FÁCIL Y RÁPIDA
- LARGA VIDA DE LA PIEZA (2.000-3.000) COCCIONES
- MEDIDAS PARA PASTELERÍA PROFESIONAL (60x40 CM)
- GAMA COMPLETA DE FORMAS

ENGLISH

THE FLEXIPAN® IS A SILICONE AND FIBRE GLASS COMBINATION MOULD SUITABLE FOR THE FOOD CONTACT. THIS MATERIAL COMBINATION GIVES TO THE PIECE SOLIDITY AND AN EXTRAORDINARY DURABILITY, ALLIED WITH EXCEPTIONAL NON-STICK PROPERTIES EITHER FOR COOKING AND FREEZING. THE FLEXIPAN® DOES NOT REQUIRE TO BE LUBRICATED SINCE THEIR COMPOSITION AND FLEXIBILITY ALLOW AN EASY AND FAST RELEASE FROM THE MOULD. ACCORDING TO THE USE AND THE MAINTENANCE, THE FLEXIPAN®, ENABLE US TO USE THEM BETWEEN 2000 AND 3000 TIMES BEFORE THE FIRST SIGNS OF STICKING ARISE. THE FLEXIPAN CAN BE USED TO BAKE (+280°C) OR FREEZE (-40°C) THE MOST SWEET AND SAVOURY PRODUCTS.

## ADVANTAGES FLEXIPAN®

- NO NEED TO BE GREASED FOR AN EASY AND QUICK REALISE
- EASY TO CLEAN
- BETWEEN 2000 AND 3000 TIMES CAN BE USED
- PROFESSIONAL PASTRY MEASURES (60x40 CM)
- LARGE RANGE OF MOULDS

FRANÇAIS

LE FLEXIPAN® EST UNE COMBINAISON DE TISSUES DE VERRE ET SILICONES ADÉQUATS POUR L'UTILISATION ALIMENTAIRE. CETTE COMBINAISON DE MATÉRIELS DONNE AU MOULE UNE SOLIDITÉ ET UNE DURABILITÉ EXTRAORDINAIRE, ALLIÉS À DES PROPRIÉTÉS ANTI-ADHÉRENTES EXCEPTIONNELLES TANT EN CUISSON COMME EN CONGÉLATION. LE FLEXIPAN® N'A PAS BESOIN D'ÊTRE LUBRIFIÉ PUISQUE SA COMPOSITION ET FLEXIBILITÉ PERMETTENT UN DÉMOULAGE FACILE ET RAPIDE. SELON L'UTILISATION ET L'ENTRETIEN DES MOULES, LE FLEXIPAN®, NOUS PERMET D'EFFECTUER ENTRE 2.000 ET 3.000 CUISSONS AVANT DE NOTER LES PREMIERS SIGNES DE COLLAGE. LE FLEXIPAN® PERMET D'EFFECTUER TOUS TYPES DE PRÉPARATIONS SUCRÉES OU SALÉES, EN CUISSON (+ 280°C) OU EN CONGÉLATION (-40°C).

## AVANTAGES FLEXIPAN®

- NE PRÉCISE D'AUCUN GRAISSAGE POUR UN DÉMOULAGE FACILE ET RAPIDE
- FACILE À NETTOYER
- DE 2000 À 3000 CUISSONS PAR MOULE
- MESURES POUR LA PÂTISSERIE PROFESSIONNELLE (60x40 CM)
- LARGE GAMME DE MOULES

DEUTSCH

FLEXIPAN® IST EINE KOMBINATION AUS FIBERGLAS UND SILIKON ANGEFASST AN DIE LEBENSMITTELVERARBEITUNG.

DIESE MATERIALKOMBINATION GIBT DER FORM SOWOHL EINE FESTIGKEIT UND EINE UNVERGLEICHLICHE LANGLEBIGKEIT, ALS AUCH ANTIHAFTEIGENSCHAFTEN WÄHREND DES BACKENS UND DER EINFRIERUNG.

FLEXIPAN® BRAUCHT KEINE EINFETTUNG AUFGRUND SEINER ZUSAMMENSTELLUNG UND ERLAUBT EINE SCHNELLE UND EINFACHE ABLÖSUNG VON DER FORM. FLEXIPAN® BIETET BEI EINEM KORREKTEN GEBRAUCH UND BEHANDLUNG DIE REALISIERUNG ZWISCHEN 2.000 UND 3.000 BACKUNGEN BEVOR MAN DIE ERSTEN VERSCHLEISSERSCHINUNGEN BEMERKT.

FLEXIPAN® ELAUBT DIE REALISIERUNG ALLER ARTEN DER ZUBEREITUNG VON NACHSPEISEN SOWOHL BEIM BACKEN (+280°C) ALS AUCH BEIM EINFRIEREN (-40°C).

## VORTEILE FLEXIPAN®

- KEINE EINFETTUNG NÖTIG UM EIN PERFEKTES ABLÖSEN VON DER FORM ZU ERREICHEN
- EINFACHSTE ABLÖSUNG DER EINGEFRORENEN STÜCKE VON DER FORM
- EINFACHE UND SCHNELLE REINIGUNG DER FORMEN
- LANGLEBIGKEIT DER FORMEN (2.000-3.000) BACKUNGEN
- GRÖSSE FÜR DIE PROFESSIONELLE PÂTISSERIE (60x40 CM)
- GROSSE PRODUKTVIelfALT

Pastelería / Pastry /  
Pâtisserie / Patisserie

Medidas  
Sizes  
Mesures  
Grösse

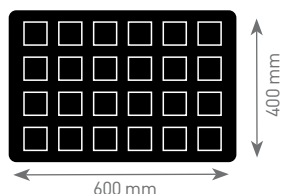

- 40 °C / - 104 °F  
+ 280 °C / + 539 °F



H.A.C.C.P.  
NO PROBLEM



MOLDES FLEXIPAN / FLEXIPAN MOULDS / MOULES FLÉXIPAN / FLEXIPANFORMEN

CONOS / CONES / CONES / KEGEL



REF	Forma	Fig	Ø mm	H mm	ml	U
P859.134		40	50	40,0	24	1
P859.135		20	70	60,0	80	1



BAVAROIS / ROSACE SHAPE / BAVAROIS / BAYERISCH



REF	Forma	Fig	Ø mm	H mm	ml	U
P859.139		18	78	35,0	100	1



CHARLOTTES



REF	Forma	Fig	Ø mm	H mm	ml	U
P859.141		24	62	35,0	60	1
P859.113		18	78	40,0	100	1



MAGDALENAS / MADELEINES / MADELEINES / MADELEINES



REF	Forma	Fig	mm	H mm	ml	U
P859.142		56	52 x 33	15,0	15	1
P859.115		40	78 x 47	19,0	35	1



CONCHAS / SAINT JACQUES SHELL / COQUILLES SAINT-JACQUES / JAKOBSMUSCHELN



REF	Forma	Fig	mm	H mm	ml	U
P859.132		24	80 x 75	20,0	70	1



## MOLDES FLEXIPAN / FLEXIPAN MOULDS / MOULES FLÉXIPAN / FLEXIPANFORMEN

## MARGARITAS / DEEP FLOWER / MARGUERITES EN RELIEF / MAGERITEN



REF	Forma	Fig	Ø mm	H mm	ml	U
P859.143		24	70	27,0	70	1



## FLORES / FLOWERS / FLEURS / BLUMEN



REF	Forma	Fig	Ø mm	H mm	ml	U
P859.144		24	78	20,0	80	1



## PIRÁMIDES / PYRAMIDS / PYRAMIDES / PYRAMIDEN

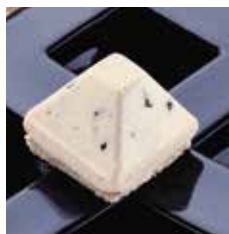

REF	Forma	Fig	mm	H mm	ml	U
P859.109		54	35 x 35	23,0	15	1
P859.111		35	50 x 50	35,0	35	1
P859.110		24	71 x 71	41,0	90	1



## SEMI-ESFERAS / HALF-SPHERES / DEMI-SPHÈRES / HALBKUGELN



REF	Forma	Fig	Ø mm	H mm	ml	U
P859.151		96	26	16,0	6	1
P859.105		70	29	18,0	10	1
P859.103		48	42	21,0	20	1
P859.102		28	58	31,0	50	1
P859.101		24	70	40,0	105	1
P859.104		24	80	40,0	126	1



## SEMI-ESFERAS INVERTIDAS / HALF-SPHERES UPSIDE DOWN / DEMI-SPHÈRES INVERSÉES / UMGEKEHRTE HALBKUGELN



REF	Forma	Fig	Ø mm	H mm	ml	U
P859.150		45	26	16,0	6	1



## CUADRADOS / SQUARES / CARRÉS / QUADRATE



REF	Forma	Fig	mm	H mm	ml	U
P859.152		60	37 x 37	17,0	18	1
P859.153		35	56 x 56	24,0	60	1



TARTELETAS CUADRADAS / SQUARE TARTLET / TARTELETTES CARRÉES / QUADRATISCHE TÖRTCHEN



REF	Forma	Fig	mm	H mm	ml	U
P859.154		60	45 x 45	12,0	20	1
P859.155		40	60 x 60	15,0	40	1



SAVARINS CUADRADAS / SQUARE SAVARINS / SAVARINS CARRÉES / QUADRATISCHE SAVARINE



REF	Forma	Fig	mm	H mm	ml	U
P859.156		60	37 x 37	17,0	15	1
P859.157		35	56 x 56	24,0	45	1
P859.158		24	70 x 70	30,0	100	1



SAVARINS REDONDOS / ROUND SAVARINS / SAVARINS RONDS / RUNDE SAVARINE



REF	Forma	Fig	Ø mm	H mm	ml	U
P859.159		60	41	12,0	10	1
P859.124		35	66	20,0	50	1
P859.219		24	70	23,0	65	1
P859.122		24	80	20,0	70	1



SAVARINS OVALADOS / OVAL SAVARINS / SAVARINS OVALES / OVALE SAVARINE



REF	Forma	Fig	mm	H mm	ml	U
P859.123		24	80 x 60	25,0	70	1



ÓVALOS / OVAL / OVALES / OVALE



REF	Forma	Fig	mm	H mm	ml	U
P859.167		30	70 x 50	30,0	75	1
P859.130		30	85 x 60	30,0	100	1



TARTELETAS OVALADAS / OVAL TARTLETS / TARTELETTES OVALES / OVALE TÖRTCHEN



REF	Forma	Fig	mm	H mm	ml	U
P859.169		48	66 x 27	11,0	10	1





## MOLDES FLEXIPAN / FLEXIPAN MOULDS / MOULES FLÉXIPAN / FLEXIPANFORMEN

## TARTELETAS REDONDAS / ROUND TARTLETS / TARTELETTES ROUNDS / RUNDE TÖRTCHEN



REF	Forma	Fig	Ø mm	H mm	ml	U
P859.114		60	42	10,0	13	1
P859.171		48	48	15,0	20	1
P859.172		40	58	20,0	35	1
P859.126		24	77	20,0	65	1



## TRONCOS / LOGS / BÛCHE / BLÖCKE



REF	Forma	Fig	mm	H mm	ml	U
P859.125		24	95 x 40	30,0	80	1
P859.183		24	122 x 42	32,0	115	1
P859.184		8	339 x 40	39,0	450	1
P859.185		5	495 x 40	39,0	700	1



## CAKES/BIZCOCHOS / CAKES-LADY FINGERS / CAKES-COUDOIRS / KUCHEN/ BISKUIT



REF	Forma	Fig	mm	H mm	ml	U
P859.186		120	40 x 15	12,0	6	1



## LINGOTES / LINGOTS / LINGOTS / BARREN



REF	Forma	Fig	mm	H mm	ml	U
P859.189		24	100 x 40	25,0	70	1
P859.190		24	120 x 40	25,0	90	1



## SEMI-CILINDROS / HALF-CYLINDRES / DEMI-CYLINDRES / HALBZYLINDER



REF	Forma	Fig	mm	H mm	ml	U
P859.191		48	85 x 17	15,0	20	1





CAKES



REF	Forma	Fig	mm	H mm	ml	U
P859.192		24	80 x 30	30,0	55	1
P859.195		16	110 x 60	25,0	105	1

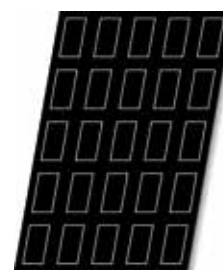

FINANCIERS



REF	Forma	Fig	mm	H mm	ml	U
P859.196		84	50 x 26	11,0	10	1
P859.197		24	86 x 46	14,0	45	1



MUFFINS



REF	Forma	Fig	Ø mm	H mm	ml	U
P859.106		40	51	29,0	45	1
P859.107		24	73	40,0	125	1
P859.198		15	82	50,0	220	1



CILINDROS / CYLINDERS / CYLINDRES / ZYLINDER



REF	Forma	Fig	Ø mm	H mm	ml	U
P859.206		48	40	20,0	25	1
P859.207		24	63	25,0	65	1
P859.117		24	63	35,0	90	1



FLORENTINA / FLORENTINERS / FLORENTINS / FLORENTINER



REF	Forma	Fig	Ø mm	H mm	ml	U
P859.129		15	102	20,0	140	1



## MOLDES FLEXIPAN / FLEXIPAN MOULDS / MOULES FLÉXIPAN / FLEXIPANFORMEN

## TARTAS TATIN / ETATIN APPLE TARTS / TARTES TATIN / TATINTORTEN



REF	Forma	Fig	Ø mm	H mm	ml	U
P859.210		15	82	30,0	135	1
P859.211		12	100	35,0	245	1
P859.212		12	105	40,0	305	1



## ENTREMETS-PIZZAS-QUICHES / ROUND-PIZZA-QUICHES / EMPREINTES RONDES-PIZZA-QUICHES / VORSPEISE-PIZZA-QUICHES



REF	Forma	Fig	Ø mm	H mm	ml	U
P859.116		6	186	12,0	300	1



## CUCHARAS / SPOONS / CUILLÈRES / LÖFFEL



REF	FORMA	FIG	MM	H MM	ML	U
P859.174		36	90 x 28	12,0	15	1



## LANZADERAS / MINI-BRIOCHES / NAVETTES / SCHIFFCHEN



REF	FORMA	FIG	MM	H MM	ML	U
P859.200		48	70 x 30	10,0	15	1



## ALARGADAS / LONG / LONGUES / LANGE



REF	Forma	Fig	mm	H mm	ml	U
P859.201		24	130 x 48	18,0	80	1



## REDONDAS / ROUNDS / RONDS / RUNDE



REF	Forma	Fig	Ø mm	H mm	ml	U
P859.202		24	79	15,0	65	1



MOLDES FLEXIPAN / FLEXIPAN MOULDS / MOULES FLÉXIPAN / FLEXIPANFORMEN

FLORES / FLOWERS / FLEURS / BLUMEN





REF	Forma	Fig	mm	H mm	ml	U
P859.203		24	62 x 49	26,0	60	1



ACANALDA / CANNELÉES / CANNELÉES / RUNDE ECKEN



REF	Forma	Fig	Ø mm	H mm	ml	U
P859.204		24	68	25,0	60	1
P859.205		24	78	30,0	105	1
P859.112		24	81	37,0	105	1



OCTÁGONOS / OCTAGONS / OCTAGONES / ACHTECKE



REF	Forma	Fig	mm	H mm	ml	U
P859.119		40	43 x 40	26,0	28	1



MEDALLONES / MEDAILLONS / MÉDAILLONS / MEDAILLEN



REF	Forma	Fig	Ø mm	H mm	ml	U
P859.179		96	28	8,0	5	1



POMPONNETTES / POMPONNETTES / POMPONNETTES / POMPONNETTES



REF	Forma	Fig	Ø mm	H mm	ml	U
P859.120		96	36	17,0	14	1



POMPONNETTES / POMPONNETTES / POMPONNETTES / POMPONNETTES



REF	Forma	Fig	Ø mm	H mm	ml	U
P859.121		54	40	20,0	22	1



# RECAMBIOS / SPARE PARTS / PIÈCES DE RECHANGE / ERSATZTEILE



## P142.000

ASADOR GRILL MANGO MADERA / GRILL WOODEN HANDLE /  
GRILL QUEUE EN BOIS / PFANNENHOLZGRIFF

REF	DESCRIPCIÓN	DESCRIPTION	DESCRIPTION	BESCHREIBUNG
RE142000	MANGO MADERA	WOODEN HANDLE	QUEUE EN BOIS	HOLZGRIFF



## P15.000

FREIDORA / FRYER /  
FRITEUSE / FRITEUSSE

REF	DESCRIPCIÓN	DESCRIPTION	DESCRIPTION	BESCHREIBUNG
RE15000	CESTA MALLA	MESH BASKET	PANIER À MAILLES	MASCHENKORB
RE150001	RESISTENCIA	ELEMENT	RÉSISTANCE	HEIZELEMENT
RE1500010	CABEZAL	COMPLETE HEAD	TÊTE COMPLÈTE	KOMPLETTER KOPF
RE1500011	TAPÓN + ARANDELA CABLE	CAP + WASHER FOR	EMBOUT + RONDELLE DE	STÖPSEL + DICHTUNGSRING FÜR
	TERMOSTATO	THERMOSTAT CABLE	CABLE DE THERMOSTAT	THERMOSTATKABEL
RE150003	TERMOSTATO	THERMOSTAT	THERMOSTAT	THERMOSTAT
RE150004	TERMOSTATO DE SEGURIDAD	SECURITY THERMOSTAT	THERMOSTAT DE SÉCURITÉ	SICHERHEITSTHERMOSTAT
RE150005	MANDO THERMOSTATO	THERMOSTAT KNOB	COMMANDE THERMOSTAT	THERMOSTATREGLER
RE150006	INTERRUPTOR DE CONTACTO	CONTACT SWITCH	INTERRUPTEUR DE CONTACT	KONTAKTSCHALTER
RE150009	LUZ PILOTO VERDE	POWER INDICATOR GREEN	VOYANT VERT	GRÜNE KONTROLLLEUCHTE
RE1500091	LUZ PILOTO NARANJA	POWER INDICATOR ORANGE	VOYANT ORANGE	ORANGE KONTROLLLEUCHTE
RE150025	CABLE POTENCIA	POWER CORD	CABLE DE PUISSANCE	STROMKABEL
RE150026	PIE	FOOT	PIED	FUSS
RE150703	ASA LATERAL BAQUELITA	BAKELITE SIDE HANDLE	ANSE LATÉRALE EN BAKÉLITE	SEITLICHR BAKELITGRIFF



## P15.001

FREIDORA / FRYER /  
FRITEUSE / FRITEUSSE

REF	DESCRIPCIÓN	DESCRIPTION	DESCRIPTION	BESCHREIBUNG
RE15000	CESTA MALLA	MESH BASKET	PANIER À MAILLES	MASCHENKORB
RE150001	RESISTENCIA	ELEMENT	RÉSISTANCE	HEIZELEMENT
RE1500010	CABEZAL	COMPLETE HEAD	TÊTE COMPLÈTE	KOMPLETTER KOPF
RE1500011	TAPÓN + ARANDELA CABLE	CAP + WASHER FOR	EMBOUT + RONDELLE DE	STÖPSEL + DICHTUNGSRING FÜR
	TERMOSTATO	THERMOSTAT CABLE	CABLE DE THERMOSTAT	THERMOSTATKABEL
RE150003	TERMOSTATO	THERMOSTAT	THERMOSTAT	THERMOSTAT
RE150004	TERMOSTATO DE SEGURIDAD	SECURITY THERMOSTAT	THERMOSTAT DE SÉCURITÉ	SICHERHEITSTHERMOSTAT
RE150005	MANDO THERMOSTATO	THERMOSTAT KNOB	COMMANDE THERMOSTAT	THERMOSTATREGLER
RE150006	INTERRUPTOR DE CONTACTO	CONTACT SWITCH	INTERRUPTEUR DE CONTACT	KONTAKTSCHALTER
RE150009	LUZ PILOTO VERDE	POWER INDICATOR GREEN	VOYANT VERT	GRÜNE KONTROLLLEUCHTE
RE1500091	LUZ PILOTO NARANJA	POWER INDICATOR ORANGE	VOYANT ORANGE	ORANGE KONTROLLLEUCHTE
RE150025	CABLE POTENCIA	POWER CORD	CABLE DE PUISSANCE	STROMKABEL
RE150026	PIE	FOOT	PIED	FUSS
RE150703	ASA LATERAL BAQUELITA	BAKELITE SIDE HANDLE	ANSE LATÉRALE EN BAKÉLITE	SEITLICHR BAKELITGRIFF



## P15.002

FREIDORA / FRYER /  
FRITEUSE / FRITEUSSE

REF	DESCRIPCIÓN	DESCRIPTION	DESCRIPTION	BESCHREIBUNG
RE15000	CESTA MALLA	MESH BASKET	PANIER À MAILLES	MASCHENKORB
RE150001	RESISTENCIA	ELEMENT	RÉSISTANCE	HEIZELEMENT
RE1500011	TAPÓN + ARANDELA CABLE	CAP + WASHER FOR +	EMBOUT + RONDELLE DE CABLE	STÖPSEL + DICHTUNGSRING FÜR
	TERMOSTATO	THERMOSTAT CABLE	DE THERMOSTAT	THERMOSTATKABEL
RE150003	TERMOSTATO	THERMOSTAT	THERMOSTAT	THERMOSTAT
RE150004	TERMOSTATO DE SEGURIDAD	SECURITY THERMOSTAT	THERMOSTAT DE SÉCURITÉ	SICHERHEITSTHERMOSTAT
RE150005	MANDO THERMOSTATO	THERMOSTAT KNOB	COMMANDE THERMOSTAT	THERMOSTATREGLER
RE150006	INTERRUPTOR DE CONTACTO	CONTACT SWITCH	INTERRUPTEUR DE CONTACT	KONTAKTSCHALTER
RE150007	CABEZAL	COMPLETE HEAD	TÊTE COMPLÈTE	KOMPLETTER KOPF
RE150008	INTERRUPTOR	ON/OFF SWITCH	INTERRUPTEUR	AN/ AUSSCHALTER
RE150009	ENCENDIDO/APAGADO		ALLUMAGE/EXTINCTION	AN/ AUSSCHALTER
	LUZ PILOTO VERDE	POWER INDICATOR GREEN	VOYANT VERT	GRÜNE KONTROLLLEUCHTE
	LUZ PILOTO NARANJA	POWER INDICATOR ORANGE	VOYANT ORANGE	ORANGE KONTROLLLEUCHTE
RE150022	GRIFO VACIADO	DRAINAGE TAP	ROBINET VIDANGE	ABLAUFHAHN
RE150023	SOPORTE RESISTENCIA	RESISTANCE SUPPORT	SUPPORT DE RÉISTANCE	HALTERUNG FÜR HEIZELEMENT
RE150024	JUNTA PROTECTORA	RESISTANCE PROTECTOR	ENSEMBLE PROTECTEUR DE	SCHUTZDICHTUNGSRING FÜR
	RESISTENCIA	SEAL	RÉSISTANCE	HEIZELEMENT
RE150025	CABLE POTENCIA	POWER CORD	CABLE DE PUISSANCE	STROMKABEL
RE150026	PIE	FOOT	PIED	FUSS





## P15.003

FREIDORA / FRYER /  
FRITEUSE / FRITTEUSE

REF	DESCRIPCIÓN	DESCRIPTION	DESCRIPTION	BESCHREIBUNG
RE15000	CESTA MALLA	MESH BASKET	PANIER À MAILLES	MASCHENKORB
RE150001	RESISTENCIA	ELEMENT	RÉSISTANCE	HEIZELEMENT
RE1500011	TAPÓN + ARANDELA CABLE	CAP + WASHER FOR	EMBOUT + RONDELLE DE	STÖPSEL + DICHTUNGSRING
	TERMOSTATO	THERMOSTAT CABLE	CABLE DE THERMOSTAT	FÜR THERMOSTATKABEL
RE150003	TERMOSTATO	THERMOSTAT	THERMOSTAT	THERMOSTAT
RE150004	TERMOSTATO DE SEGURIDAD	SECURITY THERMOSTAT	THERMOSTAT DE SÉCURITÉ	SICHERHEITSTHERMOSTAT
RE150005	MANDO THERMOSTATO	THERMOSTAT KNOB	COMMANDE THERMOSTAT	THERMOSTATREGLER
RE150006	INTERRUPTOR DE CONTACTO	CONTACT SWITCH	INTERRUPTEUR DE CONTACT	KONTAKTSCHALTER
RE150007	CABEZAL	COMPLETE HEAD	TÊTE COMPLÈTE	KOMPLETTER KOPF
RE150008	INTERRUPTOR	ON/OFF SWITCH	INTERRUPTEUR	AN/ AUSSCHALTER
	ENCENDIDO/APAGADO		ALLUMAGE/EXTINCTION	
RE150009	LUZ PILOTO VERDE	POWER INDICATOR GREEN	VOYANT VERT	GRÜNE KONTROLLLEUCHE
RE1500091	LUZ PILOTO NARANJA	POWER INDICATOR ORANGE	VOYANT ORANGE	ORANGE KONTROLLLEUCHE
RE150022	GRIFO VACIADO	DRAINAGE TAP	ROBINET VIDANGE	ABLAUFHAHN
RE150025	CABLE POTENCIA	POWER CORD	CABLE DE PUISSANCE	STROMKABEL
RE150026	PIE	FOOT	PIED	FUSS



## P15.004

GRILL DE CONTACTO / CONTACT GRILL /  
GRILL DE CONTACT / KONTAKTGRILL

REF	DESCRIPCIÓN	DESCRIPTION	DESCRIPTION	BESCHREIBUNG
RE150041	INTERRUPTOR	SWITCH	INTERRUPTEUR	SCHALTER
RE150042	TERMOSTATO	THERMOSTAT	THERMOSTAT	THERMOSTAT
RE150043	TERMOSTATO SEGURIDAD	SECURITY THERMOSTAT	THERMOSTAT SÉCURITÉ	SICHERHEITSTHERMOSTAT
RE150044	MUELLES	SPRING	RESSORTS	FEDERN
RE150045	RESISTENCIA SUPERIOR	UPPER ELEMENT	RÉSISTANCE SUPÉRIEURE	OBERES HEIZELEMENT
RE150046	RESISTENCIA INFERIOR	LOWER ELEMENT	RÉSISTANCE INFÉRIEURE	UNTERES HEIZELEMENT
RE150047	MANGO INOX	ST/STEEL HANDLE	MANCHE INOX	GRIFF ROSTFREIER STAHL
RE150048	SILICONA	SILICONE	SILICONE	SILIKON
RE150049	MANGO INOX + SILICONA	ST/STEEL HANDLE + SILICONE	MANCHE INOX + SILICONE	GRIFF ROSTFREIER STAHL + SILIKON



## P15.005

GRILL DE CONTACTO / CONTACT GRILL /  
GRILL DE CONTACT / KONTAKTGRILL

REF	DESCRIPCIÓN	DESCRIPTION	DESCRIPTION	BESCHREIBUNG
RE1500092	FIJACIÓN SOPORTE ASA	FIXING SUPPORT FOR HANDLE	FIXATION DE SUPPORT	GRIFFHALTERUNG
		SWITCH	POUR ANSE	
RE150041	INTERRUPTOR	THERMOSTAT	INTERRUPTEUR	SCHALTER
RE150042	TERMOSTATO	SECURITY THERMOSTAT	THERMOSTAT	THERMOSTAT
RE150043	TERMOSTATO SEGURIDAD	SPRING	THERMOSTAT SÉCURITÉ	SICHERHEITSTHERMOSTAT
RE150044	MUELLES	UPPER ELEMENT	RESSORTS	FEDERN
RE150051	RESISTENCIA SUPERIOR	LOWER ELEMENT	RÉSISTANCE SUPÉRIEURE	OBERES HEIZELEMENT
RE150052	RESISTENCIA INFERIOR	REAR AXLE	RÉSISTANCE INFÉRIEURE	UNTERES HEIZELEMENT
RE150053	EJE POSTERIOR	HANDLE	AXE POSTÉRIEUR	OBERE ACHSE
RE150054	MANGO	SILICONE	MANCHE	GRIFF
RE150055	SILICONA	ST/STEEL HANDLE + SILICONE	SILICONE	SILIKON
RE150056	MANGO INOX + SILICONA		MANCHE INOX + SILICONE	GRIFF ROSTFREIER STAHL + SILIKON

## P15.006

GRILL DE CONTACTO / CONTACT GRILL /  
GRILL DE CONTACT / KONTAKTGRILL

REF	DESCRIPCIÓN	DESCRIPTION	DESCRIPTION	BESCHREIBUNG
RE1500092	FIJACIÓN SOPORTE ASA	FIXING SUPPORT FOR HANDLE	FIXATION DE SUPPORT	GRIFFHALTERUNG
			POUR ANSE	
RE150041	INTERRUPTOR	SWITCH	INTERRUPTEUR	SCHALTER
RE150042	TERMOSTATO	THERMOSTAT	THERMOSTAT	THERMOSTAT
RE150043	TERMOSTATO SEGURIDAD	SECURITY THERMOSTAT	THERMOSTAT SÉCURITÉ	SICHERHEITSTHERMOSTAT
RE150044	MUELLES	SPRING	RESSORTS	FEDERN
RE150051	RESISTENCIA SUPERIOR	UPPER ELEMENT	RÉSISTANCE SUPÉRIEURE	OBERES HEIZELEMENT
RE150052	RESISTENCIA INFERIOR	LOWER ELEMENT	RÉSISTANCE INFÉRIEURE	UNTERES HEIZELEMENT
RE150053	EJE POSTERIOR	REAR AXLE	AXE POSTÉRIEUR	OBERE ACHSE
RE150054	MANGO	HANDLE	MANCHE	GRIFF
RE150055	SILICONA	SILICONE	SILICONE	SILIKON
RE150056	MANGO INOX + SILICONA	ST/STEEL HANDLE + SILICONE	MANCHE INOX + SILICONE	GRIFF ROSTFREIER STAHL + SILIKON
RE150061	PLANCHA LISA INFERIOR	LOWER SMOOTH PLATE	PLANCHE LISSE INFÉRIEURE	+ SILIKON



### P15.007

GRILL DE CONTACTO / CONTACT GRILL /  
GRILL DE CONTACT / KONTAKTGRILL

REF	DESCRIPCIÓN	DESCRIPTION	DESCRIPTION	BESCHREIBUNG
RE150041	INTERRUPTOR	SWITCH	INTERRUPTEUR	SCHALTER
RE150042	TERMOSTATO	THERMOSTAT	THERMOSTAT	THERMOSTAT
RE150043	TERMOSTATO SEGURIDAD	SECURITY THERMOSTAT	THERMOSTAT SÉCURITÉ	SICHERHEITSTHERMOSTAT
RE150044	MUELLES	SPRING	RESSORTS	FEDERN

### P15.008

GRILL DE CONTACTO / CONTACT GRILL /  
GRILL DE CONTACT / KONTAKTGRILL

REF	DESCRIPCIÓN	DESCRIPTION	DESCRIPTION	BESCHREIBUNG
RE150041	INTERRUPTOR	SWITCH	INTERRUPTEUR	SCHALTER
RE150042	TERMOSTATO	THERMOSTAT	THERMOSTAT	THERMOSTAT
RE150043	TERMOSTATO SEGURIDAD	SECURITY THERMOSTAT	THERMOSTAT SÉCURITÉ	SICHERHEITSTHERMOSTAT
RE150044	MUELLES	SPRING	RESSORTS	FEDERN
RE150061	PLANCHA LISA INFERIOR	LOWER SMOOTH PLATE	PLANCHE LISSE INFÉRIEURE	UNTERE GLATTE PLATTE



### P15.009

GRILL DE CONTACTO / CONTACT GRILL /  
GRILL DE CONTACT / KONTAKTGRILL

REF	DESCRIPCIÓN	DESCRIPTION	DESCRIPTION	BESCHREIBUNG
RE1500092	FIJACIÓN SOPORTE ASA	FIXING SUPPORT FOR HANDLE	FIXATION DE SUPPORT POUR ANSE	GRIFFHALTERUNG
RE150041	INTERRUPTOR	SWITCH	INTERRUPTEUR	SCHALTER
RE150042	TERMOSTATO	THERMOSTAT	THERMOSTAT	THERMOSTAT
RE150043	TERMOSTATO SEGURIDAD	SECURITY THERMOSTAT	THERMOSTAT SÉCURITÉ	SICHERHEITSTHERMOSTAT
RE150044	MUELLES	SPRING	RESSORTS	FEDERN



### P15.010

BAÑO MARIA MÁX. 40 °C / CHOCOLATE WARMER MAX. 40 °C /  
CHAUFFE-CHOCOLAT MAX. 40 °C / WASSERBAD MAX. 40 °C

REF	DESCRIPCIÓN	DESCRIPTION	DESCRIPTION	BESCHREIBUNG
RE150101	TERMOSTATO	THERMOSTAT	THERMOSTAT	THERMOSTAT
RE150102	RESISTENCIA	ELEMENT	RÉSISTANCE	HEIZELEMENT



### P15.026

CALENTADOR DE PLATOS CAPACIDAD 30 U / HOT CUPBOARD CAPACITY 30 U /  
CHAUFFE-ASSIETTES CAPACITÉ 30 U / TELLERWÄRMER FASSUNGSVERMÖGEN 30 STÜCK

REF	DESCRIPCIÓN	DESCRIPTION	DESCRIPTION	BESCHREIBUNG
RE150260	SOPORTE PIE	SUPPORT FOOT	SUPPORT PIED	FUSSHALTER
RE150261	ESTANTE	SHELF	ÉTAGÈRE	REGAL
RE150262	RESISTENCIA	ELEMENT	RÉSISTANCE	HEIZELEMENT
RE150263	SOPORTE	SUPPORT	SUPPORT	HALTER



### P15.027

CALENTADOR DE PLATOS CAPACIDAD 60 U / HOT CUPBOARD CAPACITY 60 U /  
CHAUFFE-ASSIETTES CAPACITÉ 60 U / TELLERWÄRMER FASSUNGSVERMÖGEN 60 STÜCK

REF	DESCRIPCIÓN	DESCRIPTION	DESCRIPTION	BESCHREIBUNG
RE150271	ESTANTE	SHELF	ÉTAGÈRE	REGAL
RE150272	RESISTENCIA	ELEMENT	RÉSISTANCE	HEIZELEMENT



### P15028

CALENTADOR DE PLATOS CAPACIDAD 120 U / HOT CUPBOARD CAPACITY 120 U /  
CHAUFFE-ASSIETTES CAPACITÉ 120 U / TELLERWÄRMER FASSUNGSVERMÖGEN 120 STÜCK

REF	DESCRIPCIÓN	DESCRIPTION	DESCRIPTION	BESCHREIBUNG
RE150281	ESTANTE	SHELF	ÉTAGÈRE	REGAL
RE150282	RESISTENCIA	ELEMENT	RÉSISTANCE	HEIZELEMENT



### P15.035

HORNO MULTIFUNCIONAL DE CONVECCIÓN / CONVECTION OVEN /  
FOUR À AIR PULSE / KONFEKTIONSOFEN

REF	DESCRIPCIÓN	DESCRIPTION	DESCRIPTION	BESCHREIBUNG
RE15035	REJILLA	GRID	GRILLE	GRILLROST
RE1503510	MANDO TEMPORIZADOR	TIMER KNOB	COMMANDE TEMPORISATEUR	TIMERKNOPF
RE1503511	CRISTAL EXTERIOR	GLASS EXTERIOR	VITRE EXTÉRIEURE	AUSSENGLAS
RE1503512	TIRADOR	HANDLE	POIGNÉE	GRIFF
RE1503513	CRISTAL INTERIOR	GLASS INTERIOR	VITRE INTÉRIEURE	INNENGLAS
RE1503514	SOPORTE INFERIOR CRISTAL	GLASS BOTTOM SUPPORT	SUPPORT INFÉRIEUR EN VERRE	HALTER FÜR INNENGLAS
RE1503515	SOPORTE FIJO BISAGRA PARA PUERTA	FIXED SUPPORT WITH HINGE FOR DOOR	SUPPORT FIXE AVEC CHARNIÈRE POUR PORTE	FESTER SCHANIERHALTER FÜR DIE TÜR
RE1503516	SOPORTE TIRADOR PUERTA	DOOR HANDLE SUPPORT	SUPPORT AVEC POIGNÉE DE PORTE	TÜRGRIFHALTER
RE1503517	BOMBILLA	LIGHT BULB	AMPOULLE	LAMPE
RE1503518	PROTECTOR BOMBILLA	LIGHT BULB PROTECTOR	PROTECTION D'AMPOULLE	LAMPENSCHUTZ
RE150352	BANDEJA	TRAY	PLATEAU	TABLETT
RE150353	GOMA	RUBBER	CAOUTCHOUC	GUMMI
RE150354	TERMOSTATO	THERMOSTAT	THERMOSTAT	THERMOSTAT
RE150355	TERMOSTATO SEGURIDAD	SECURITY THERMOSTAT	THERMOSTAT SÉCURITÉ	SICHERHEITSTHERMOSTAT
RE150356	BISAGRA	HINGE	CHARNIÈRE	SCHANIER
RE150357	RESISTENCIA	ELEMENT	RÉSISTANCE	HEIZELEMENT
RE150358	VENTILADOR - MOTOR	FAN - MOTOR	VENTILATEUR - MOTEUR	VENTILATIONSMOTOR
RE150359	TEMPORIZADOR	TIMER	TEMPORISATEUR	TIMER



### P15.036

SALAMANDRA CON PARTE SUPERIOR REGULABLE / SALAMANDER WITH ADJUSTABLE TOP /  
SALAMANDRE AVEC REGULATION DU PLAFOND / SALAMANDER MIT BEWEGLICHEM OBERTEIL

REF	DESCRIPCIÓN	DESCRIPTION	DESCRIPTION	BESCHREIBUNG
RE150361	RESISTENCIA	ELEMENT	RÉSISTANCE	HEIZELEMENT
RE150362	BANDEJA GOTEO	DRIP PLATE	PLATEAU ÉGOUTTAGE	TROPFGITTER
RE150363	TERMOSTATO	THERMOSTAT	THERMOSTAT	THERMOSTAT



### P15.038

TOSTADORA PARA SANDWICH CON 3 Y 6 PINZAS / SANDWICH TOASTER WITH 3 & 6 TONGS /  
TOASTEUR À SANDWICH AVEC 3 ET 6 PINCES / SANDWICHTOASTER MIT 3 UND 6 ZANGEN

REF	DESCRIPCIÓN	DESCRIPTION	DESCRIPTION	BESCHREIBUNG
RE150381	RESISTENCIA	ELEMENT	RÉSISTANCE	HEIZELEMENT
RE150382	TERMOSTATO	THERMOSTAT	THERMOSTAT	THERMOSTAT
RE150383	MANDO TEMPORIZADOR	TIMER KNOB	COMMANDE TEMPORISATEUR	TIMERKNOPF
RE150384	MANDO TERMOSTATO	THERMOSTAT KNOB	COMMANDE THERMOSTAT	THERMOSTATREGLER
RE150385	TEMPORIZADOR	TIMER	TEMPORISATEUR	TIMER
RE150386	REGLETA CERÁMICA	CERAMICAL TERMINAL	RÈGLETTE EN CÉRAMIQUE	KERAMISCHE SCHINE
RE150387	PRENSA ESTOPAS	CABLE GLAND	PRESSE-ÉTOUPES	PRESSE- TUCH
RE150388	AISLAMIENTO CERÁMICO	CERAMIC INSULATOR	ISOLANT EN CÉRAMIQUE	KERAMISCHE ISOLIERUNG
RE15039	PINZA SANDWICH	SANDWICH TONG	PINCE À SANDWICH	SANDWICHZANGE
RE150391	REGLETA	TERMINAL	RÈGLETTE	SCHIENE



### P15.039

TOSTADORA PARA SANDWICH CON 3 Y 6 PINZAS / SANDWICH TOASTER WITH 3 & 6 TONGS /  
TOASTEUR À SANDWICH AVEC 3 ET 6 PINCES / SANDWICHTOASTER MIT 3 UND 6 ZANGEN

REF	DESCRIPCIÓN	DESCRIPTION	DESCRIPTION	BESCHREIBUNG
RE150382	TERMOSTATO	THERMOSTAT	THERMOSTAT	THERMOSTAT
RE150383	MANDO TEMPORIZADOR	TIMER KNOB	COMMANDE TEMPORISATEUR	TIMERKNOPF
RE150384	MANDO TERMOSTATO	THERMOSTAT KNOB	COMMANDE THERMOSTAT	THERMOSTATREGLER
RE150385	TEMPORIZADOR	TIMER	TEMPORISATEUR	TIMER
RE150386	REGLETA CERÁMICA	CERAMICAL TERMINAL	RÈGLETTE EN CÉRAMIQUE	KERAMISCHE SCHIENE
RE150387	PRENSA ESTOPAS	CABLE GLAND	PRESSE-ÉTOUPES	PRESSE- TUCH
RE150388	AISLAMIENTO CERÁMICO	CERAMIC INSULATOR	ISOLANT EN CÉRAMIQUE	KERAMISCHE ISOLIERUNG
RE15039	PINZA SANDWICH	SANDWICH TONG	PINCE À SANDWICH	SANDWICHZANGE
RE150391	REGLETA	TERMINAL	RÈGLETTE	SCHIENE
RE1503919A	RESISTENCIA	ELEMENT	RÉSISTANCE	HEIZELEMENT



### P15.040

TOSTADORA / TOASTER /  
TOASTEUR / TOASTER

REF	DESCRIPCIÓN	DESCRIPTION	DESCRIPTION	BESCHREIBUNG
RE150400	PIÉS	FEET	PIEDS	FÜSSE
RE150401	RESISTENCIA 500W	500W ELEMENT	RÉSISTANCE 500W	HEIZELEMENT 500W
RE150402	RESISTENCIA 370W	370W ELEMENT	RÉSISTANCE 370W	HEIZELEMENT 370W
RE150403	TEMPORIZADOR	TIMER	TEMPORISATEUR	TIMER
RE150404	INTERRUPTOR	SWITCH	INTERRUPTEUR	SCHALTER
RE150405	MANDO TEMPORIZADOR	TIMER KNOB	COMMANDE TEMPORISATEUR	TIMERKNOPF



### P15.041

TOSTADORA / TOASTER /  
TOASTEUR / TOASTER

REF	DESCRIPCIÓN	DESCRIPTION	DESCRIPTION	BESCHREIBUNG
RE150400	PIÉS	FEET	PIEDS	FÜSSE
RE150403	TEMPORIZADOR	TIMER	TEMPORISATEUR	TIMER
RE150404	INTERRUPTOR	SWITCH	INTERRUPTEUR	SCHALTER
RE150405	MANDO TEMPORIZADOR	TIMER KNOB	COMMANDE TEMPORISATEUR	TIMERKNOPF
RE150411	RESISTENCIA 500W	500W ELEMENT	RÉSISTANCE 500W	HEIZELEMENT 500W
RE150412	RESISTENCIA 370W	370W ELEMENT	RÉSISTANCE 370W	HEIZELEMENT 370W



### P15.042

TOSTADORA CONTINUA / CONVEYOR TOASTER /  
TOASTEUR CONVEYEUR / DURCHLAUFTOASTER

REF	DESCRIPCIÓN	DESCRIPTION	DESCRIPTION	BESCHREIBUNG
RE150421	RESISTENCIA SUPERIOR	UPPER ELEMENT	RÉSISTANCE SUPERIOR	OBERES HEIZELEMENT
RE150422	RESISTENCIA INFERIOR	LOWER ELEMENT	RÉSISTANCE INFÉRIEURE	UNTERES HEIZELEMENT
RE150423	MOTOR	MOTOR	MOTEUR	MOTOR
RE150424	VENTILADOR	FAN	VENTILATEUR	VENTILATOR
RE150425	SELECTION SWITCH	SELECTION SWITCH	SÉLECTION INTERRUPTEUR	AUSWAHLSCHALTER
RE150426	REGULADOR VELOCIDAD	ADJUSTABLE SPEED	RÉGULATEUR VITESSE	GESCHWINDIGKEITSREGLER
RE150427	POTENCIOMETRO	POTENTIOMETER	POTENCIOMÈTRE	POTENZREGLER
RE150428	POMO	KNOB	POMMEAU	KNOPF



### P15.044

MÁQUINA DE COCER PASTA / PASTA COOKER /  
CUISEUR À PÂTE / NUDELKOCHER

REF	DESCRIPCIÓN	DESCRIPTION	DESCRIPTION	BESCHREIBUNG
RE150441	CESTA MALLA GRANDE CON ASAS	BIG MESH BASKET WITH HANDLES	PANIER GRANDE MAILLE À ANSES	GROSSER MASCHENKORB MIT GRIFFEN
RE150442	CESTA MALLA PEQUEÑA CON MANGO	SMALL MESH BASKET WITH HANDLE	PANIER PETITE MAILLE À MANCHE	KLEINER MASCHENKORB MIT GRIFFEN
RE150443	TERMOSTATO	THERMOSTAT	THERMOSTAT	THERMOSTAT
RE150444	GRIFO DESAGUE	DRAINAGE TAP	ROBINET ÉCOULEMENT	ABLAUFHAHN
RE150445	CONEXIÓN BM GRIFO DRENAJE	BM CONNECTION DRAINING TAP	CONNECTION BM ROBINET DE DRAINAGE	BM VERBINDUNG ABLAUFHAHN



### P15.070

FREIDORA / FRYER /  
FRITEUSE / FRITEUSSE

REF	DESCRIPCIÓN	DESCRIPTION	DESCRIPTION	BESCHREIBUNG
RE1500011	TAPÓN + ARANDELA CABLE	CAP + WASHER FOR THERMOSTAT CABLE	EMBOUT + RONDELLE DE CABLE DE THERMOSTAT	STÖPSEL + DICHTUNGSRING FÜR THERMOSTATKABEL
RE150003	TERMOSTATO	THERMOSTAT	THERMOSTAT	THERMOSTAT
RE150004	TERMOSTATO DE SEGURIDAD	SECURITY THERMOSTAT	THERMOSTAT DE SÉCURITÉ	SICHERHEITSTHERMOSTAT
RE150005	MANDO TERMOSTATO	THERMOSTAT KNOB	COMMANDE THERMOSTAT	THERMOSTATREGLER
RE150006	INTERRUPTOR DE CONTACTO	CONTACT SWITCH	INTERRUPTEUR DE CONTACT	KONTAKTSCHALTER
RE150009	LUZ PILOTO VERDE	POWER INDICATOR GREEN	VOYANT VERT	GRÜNE KONTROLLLEUCHE
RE1500091	LUZ PILOTO NARANJA	POWER INDICATOR ORANGE	VOYANT ORANGE	ORANGE KONTROLLLEUCHE
RE150025	CABLE POTENCIA	POWER CORD	CABLE DE PUISSANCE	STROMKABEL
RE150026	PIE	FOOT	PIED	FUSS
RE15070	CESTA MALLA	MESH BASKET	PANIER MAILLE	MASCHENKORB
RE150701	RESISTENCIA	ELEMENT	RÉSISTANCE	HEIZELEMENT
RE150702	CABEZAL PARA	HEAD	TÊTE	KOPF
RE150703	ASA LATERAL BAQUELITA	BAKELITE SIDE HANDLE	ANSE LATÉRALE EN BAKÉLITE	SEITLICHR BAKELITGRIF





## P15.071

FREIDORA / FRYER /  
FRITEUSE / FRITEUSSE

REF	DESCRIPCIÓN	DESCRIPTION	DESCRIPTION	BESCHREIBUNG
RE1500011	TAPÓN + ARANDELA CABLE TERMOSTATO	CAP + WASHER FOR THERMOSTAT CABLE	EMBOUT + RONDELLE DE CABLE DE THERMOSTAT	STÖPSEL + DICHTUNGSRING FÜR THERMOSTATKABEL
RE150003	TERMOSTATO	THERMOSTAT	THERMOSTAT	THERMOSTAT
RE150004	TERMOSTATO DE SEGURIDAD	SECURITY THERMOSTAT	THERMOSTAT DE SÉCURITÉ	SICHERHEITSTHERMOSTAT
RE150005	MANDO TERMOSTATO	THERMOSTAT KNOB	COMMANDE THERMOSTAT	THERMOSTATREGLER
RE150006	INTERRUPTOR DE CONTACTO	CONTACT SWITCH	INTERRUPTEUR DE CONTACT	KONTAKTSCHALTER
RE150009	LUZ PILOTO VERDE	POWER INDICATOR GREEN	VOYANT VERT	GRÜNE KONTROLLLEUCHTE
RE1500091	LUZ PILOTO NARANJA	POWER INDICATOR ORANGE	VOYANT ORANGE	ORANGE KONTROLLLEUCHTE
RE150025	CABLE POTENCIA	POWER CORD	CABLE DE PUISSANCE	STROMKABEL
RE150026	PIE	FOOT	PIED	FUSS
RE15070	CESTA MALLA	MESH BASKET	PANIER MAILLE	MASCHENKORB
RE150701	RESISTENCIA	ELEMENT	RÉSISTANCE	HEIZELEMENT
RE150702	CABEZAL PARA	HEAD	TÊTE	KOPF
RE150703	ASA LATERAL BAQUELITA	BAKELITE SIDE HANDLE	ANSE LATÉRALE EN BAKÉLITE	SEITLICH BAKELITGRIF



## P15.073 / P15.074

PLACA CALIENTE / HEATING PLATE /  
PLAQUE CHAUFFANTE / WÄRMEPLATTE

REF	DESCRIPCIÓN	DESCRIPTION	DESCRIPTION	BESCHREIBUNG
RE150740	PIE	BASE	PIED	FUSS



## P15.075

CRÊPERA - CRÊPERA DOBLE / CRÊPE MAKER - DOUBLE CRÊPE MAKER /  
CRÊPIÈRE - CRÊPIÈRE DOUBLE / CRÊPEEISEN

REF	DESCRIPCIÓN	DESCRIPTION	DESCRIPTION	BESCHREIBUNG
RE150751	RESISTENCIA	ELEMENT	RÉSISTANCE	HEIZELEMENT



## P15.084

PLANCHA ELÉCTRICA LISA / ELECTRIC GRIDDLE PLAIN /  
PLAQUE ÉLECTRIQUE UNIE / GLATTER ELEKTRISCHER GRILL

REF	DESCRIPCIÓN	DESCRIPTION	DESCRIPTION	BESCHREIBUNG
RE150841	RESISTENCIA	ELEMENT	RÉSISTANCE	HEIZELEMENT



## P15.097

FUENTE FONDUE CHOCOLATE / CHOCOLATE FOUNTAIN /  
FONTAINE À CHOCOLAT / SCHOKOLADENBRUNNEN

REF	DESCRIPCIÓN	DESCRIPTION	DESCRIPTION	BESCHREIBUNG
RE150971	ESPIRAL INTERIOR PLÁSTICO	INTERIOR PLASTIC SPIRALE	SPIRALE INTÉRIEUR EN PLASTIQUE	EINNERE PLASTIKSPIRALE
RE1509741	CARCASA CILÍNDRICA	CYLINDRICAL CARCASE	CARCASSE CYLINDRIQUE	ZYLINDERGEHÄUSE
RE1509744	POMO DE PLÁSTICO	PLASTIC KNOB	POMMEAU EN PLASTIQUE	PLASTIKKNOPF
RE150978	ARANDELA SILICONA	SILICONE WASHER	RONDELLE EN SILICONE	SILIKONDICHTUNG
RE1509799	KIT FUENTE	FOUNTAIN KIT	KIT SOURCE	BRUNNENSET



## P19.114-N / P19.114-A / P19.114-R

POSTE CON CINTA RETRÁCTIL ACERO INOX BRILLANTE / BARRIER WITH RETRACTABLE BELT. MIRROR POLISHED /  
POTEAU DÉROULEUR À SANGLE. ACIER INOX BRILLANT / SEPERATIONSPFOSTEN MIT EINZIEHBAREM BAND GLÄNZEND

REF	DESCRIPCIÓN	DESCRIPTION	DESCRIPTION	BESCHREIBUNG
RE191110	PIEZA PLÁSTICO	PLASTIC PIECE	PIÈCE EN PLASTIQUE	PLASTIKTEIL
RE191140	BASE	BASE	BASE	BASIS



## P248.028 / P248.032 / P248.035 / P248.040 / P248.045

OLLA CON GRIFO Y TAPA / STOCK POT WITH TAP AND LID /  
MARMITE TRAITEUR AVEC ROBINET ET COUVERCLE / KOCHTOPF MIT ABLAUFHAHN UND DECKEL

REF	DESCRIPCIÓN	DESCRIPTION	DESCRIPTION	BESCHREIBUNG
IV248000	GRIFO INOX	INOX TAP	ROBINET INOX	GRIF ROSTFREIER STAHL



### P313.025

PASAPURÉS / VEGETABLE SIEVE /  
MOULIN À LÉGUMES / PÜRIERSIEB

REF	DESCRIPCIÓN	DESCRIPTION	DESCRIPTION	BESCHREIBUNG
RE3130251	FILTRO FINO	THIN FILTER	FILTRE FIN	FEINER FILTER
RE3130252	FILTRO GRUESO	THICK FILTER	FILTRE EPAIS	GROBER FILTER
RE3130253	POMO	KNOB	POMMEAU	KNOPF
RE3130254	MECANISMO	MECHANISM	MÉCANISME	MECHANISMUS
RE3130255	ASA	HANDLE	ANSE	GRIFF

### P313.030

PASAPURÉS / VEGETABLE SIEVE /  
MOULIN À LÉGUMES / PÜRIERSIEB

REF	DESCRIPCIÓN	DESCRIPTION	DESCRIPTION	BESCHREIBUNG
RE3130301	FILTRO FINO	THIN FILTER	FILTRE FIN	FEINER FILTER
RE3130302	FILTRO GRUESO	THICK FILTER	FILTRE EPAIS	GROBER FILTER
RE3130303	POMO	KNOB	POMMEAU	KNOPF
RE3130304	MECANISMO	MECHANISM	MÉCANISME	MECHANISMUS



### P313.126

PASAPURÉS / VEGETABLE SIEVE /  
MOULIN À LÉGUMES / PÜRIERSIEB

REF	DESCRIPCIÓN	DESCRIPTION	DESCRIPTION	BESCHREIBUNG
RE3130261	FILTRO FINO	THIN FILTER	FILTRE FIN	FEINER FILTER
RE3130262	FILTRO GRUESO	THICK FILTER	FILTRE EPAIS	GROBER FILTER
RE3130263	POMO	KNOB	POMMEAU	KNOPF
RE3130264	MECANISMO	MECHANISM	MÉCANISME	MECHANISMUS

### P313.132

PASAPURÉS / VEGETABLE SIEVE /  
MOULIN À LÉGUMES / PÜRIERSIEB

REF	DESCRIPCIÓN	DESCRIPTION	DESCRIPTION	BESCHREIBUNG
RE3130263	POMO	KNOB	POMMEAU	FEINER FILTER
RE3130321	FILTRO FINO	THIN FILTER	FILTRE FIN	GROBER FILTER
RE3130322	FILTRO GRUESO	THICK FILTER	FILTRE EPAIS	KNOPF
RE3130324	MECANISMO	MECHANISM	MÉCANISME	MECHANISMUS



### P602.015

BALANZA MECÁNICA / MECHANICAL SCALE /  
BALANCE AUTOMATIQUE / MECHANISCHE WAAGE

REF	DESCRIPCIÓN	DESCRIPTION	DESCRIPTION	BESCHREIBUNG
RE602015	BANDEJA	TRAY	PLATEAU	TABLETT



### P641.100

CARRO DE SERVICIO / TROLLEY /  
CHARIOT DE SERVICE / SERVICEWAGEN

REF	DESCRIPCIÓN	DESCRIPTION	DESCRIPTION	BESCHREIBUNG
RE641101	TUBO	TUBE	TUBE	ROHR
RE641102	RUEDAS	WHEELS	ROUES	RÄDER
RE641103	BANDEJAS	TRAYS	PLATEAUS	TABLETTES
RE641104	ASAS	HANDLES	ANSES	GRIFFE



### P81.000

ARMARIO CALIENTE / HOT CUPBOARD /  
ARMOIRE CHAUDE / HEIZSCHRANK

REF	DESCRIPCIÓN	DESCRIPTION	DESCRIPTION	BESCHREIBUNG
RE81000	MANETA INOX CON LLAVE	INOX HANDLE WITH KEY	MANETTE INOX AVEC CLÉ	TÜRGRIF MIT SCHLÜSSEL ROSTFREIER STAHL



### P830.001 / P830.002

EMBUDO DOSIFICADOR / CONFECTIONERY FUNNEL /  
ENTONNOIR DOSEUR / DOSIERUNGSTRICHTER

REF	DESCRIPCIÓN	DESCRIPTION	DESCRIPTION	BESCHREIBUNG
RE8300010	BOQUILLA 4 mm	TUBE	DOUILLE	TÜLLE 4 MM
RE8300011	BOQUILLA 6 mm	TUBE	DOUILLE	TÜLLE 6 MM



### P834.000

TAPA RECTANGULAR GN POLICARBONATO / GN POLYCARBONATE RECTANGULAR LID /  
COUVERCLE RECTANGULAIRE GN POLYCARBONATE / RECHTECKIGER GN DDECKEL POLYCARBONAT

REF	DESCRIPCIÓN	DESCRIPTION	DESCRIPTION	BESCHREIBUNG
RE834000	ASAS	HANDLES	ANSES	GRIFFE



### P835.000

CAMPANA GN POLICARBONATO / GN POLYCARBONATE DOME LID /  
DÔME PROTECTION GN POLYCARBONATE / GN HAUBE POLYCARBONAT

REF	DESCRIPCIÓN	DESCRIPTION	DESCRIPTION	BESCHREIBUNG
RE835000	ASAS	HANDLES	ANSES	GRIFFE



### P837.003

EXPOSITOR TARTAS ALUMINIO / ALUMINIUM CAKE STAND /  
PRÉSENTOIR TARTES ALUMINIUM / TORTENSTÄNDER ALUMINIUM

REF	DESCRIPCIÓN	DESCRIPTION	DESCRIPTION	BESCHREIBUNG
RE837106	DISCO 20 cm	DISK 20 cm	DISQUE 20 cm	SCHEIBE 20 CM
RE837107	DISCO 26 cm	DISK 26 cm	DISQUE 26 cm	SCHEIBE 26 CM
RE837108	DISCO 32 cm	DISK 32 cm	DISQUE 32 cm	SCHEIBE 32 CM
RE837112	TORNILLO SUPERIOR	HEAD SCREW	VIS SUPÉRIEUR	KOPFSCHRAUBE
RE837113	PATA DE LA BASE CON TORNILLO	OUTSIDE FOOT WITH SCREW	PIED DE LA BASE AVEC VIS	STÄNDERFUSS MIT SCHRAUBE
RE837114	TUBO CENTRAL (UNA PARTE)	CONNECTION (PILLAR)	TUBE CENTRAL (UNE PARTIE)	ZENTRALROHR (EIN STÜCK)
RE837115	PATA CENTRAL	MIDDLE FOOT	PIED CENTRAL	ZENTRALFUSS

### P837.005

EXPOSITOR TARTAS ALUMINIO / ALUMINIUM CAKE STAND /  
PRÉSENTOIR TARTES ALUMINIUM / TORTENSTÄNDER ALUMINIUM

REF	DESCRIPCIÓN	DESCRIPTION	DESCRIPTION	BESCHREIBUNG
RE837106	DISCO 20 cm	DISK 20 cm	DISQUE 20 cm	SCHEIBE 20 CM
RE837107	DISCO 26 cm	DISK 26 cm	DISQUE 26 cm	SCHEIBE 26 CM
RE837108	DISCO 32 cm	DISK 32 cm	DISQUE 32 cm	SCHEIBE 32 CM
RE837109	DISCO 40 cm	DISK 40 cm	DISQUE 40 cm	SCHEIBE 40 CM
RE837110	DISCO 45 cm	DISK 45 cm	DISQUE 45 cm	SCHEIBE 45 CM
RE837112	TORNILLO SUPERIOR	HEAD SCREW	VIS SUPÉRIEUR	KOPFSCHRAUBE
RE837113	PATA DE LA BASE CON TORNILLO	OUTSIDE FOOT WITH SCREW	PIED DE LA BASE AVEC VIS	STÄNDERFUSS MIT SCHRAUBE
RE837114	TUBO CENTRAL (UNA PARTE)	CONNECTION (PILLAR)	TUBE CENTRAL (UNE PARTIE)	ZENTRALROHR (EIN STÜCK)
RE837115	PATA CENTRAL	MIDDLE FOOT	PIED CENTRAL	ZENTRALFUSS

### P837.007

EXPOSITOR TARTAS ALUMINIO / ALUMINIUM CAKE STAND /  
PRÉSENTOIR TARTES ALUMINIUM / TORTENSTÄNDER ALUMINIUM

REF	DESCRIPCIÓN	DESCRIPTION	DESCRIPTION	BESCHREIBUNG
RE837105	DISCO 16 cm	DISK 16 cm	DISQUE 16 cm	SCHEIBE 16 CM
RE837106	DISCO 20 cm	DISK 20 cm	DISQUE 20 cm	SCHEIBE 20 CM
RE837107	DISCO 26 cm	DISK 26 cm	DISQUE 26 cm	SCHEIBE 26 CM
RE837108	DISCO 32 cm	DISK 32 cm	DISQUE 32 cm	SCHEIBE 32 CM
RE837109	DISCO 40 cm	DISK 40 cm	DISQUE 40 cm	SCHEIBE 40 CM
RE837110	DISCO 45 cm	DISK 45 cm	DISQUE 45 cm	SCHEIBE 45 CM
RE837111	DISCO 50 cm	DISK 50 cm	DISQUE 50 cm	SCHEIBE 50 CM
RE837112	TORNILLO SUPERIOR	HEAD SCREW	VIS SUPÉRIEUR	KOPFSCHRAUBE
RE837113	PATA DE LA BASE CON TORNILLO	OUTSIDE FOOT WITH SCREW	PIED DE LA BASE AVEC VIS	STÄNDERFUSS MIT SCHRAUBE
RE837114	TUBO CENTRAL (UNA PARTE)	CONNECTION (PILLAR)	TUBE CENTRAL (UNE PARTIE)	ZENTRALROHR (EIN STÜCK)
RE837115	PATA CENTRAL	MIDDLE FOOT	PIED CENTRAL	ZENTRALFUSS



### P868.001 / P868.002 / P868.003

DISPENSADOR A PRESIÓN / SQUEEZE DISPENSER /  
DISTRIBUTEUR À PRESSION / DRUCKDOSSIERER

REF	DESCRIPCIÓN	DESCRIPTION	DESCRIPTION	BESCHREIBUNG
RE868123	TAPÓN ROJO	RED LID	EMBOUT ROUGE	ROTER DECKEL
RE868456	TAPÓN AMARILLO	YELLOW LID	EMBOUT JAUNE	GELBER DECKEL
RE868789	TAPÓN TRANSPARENTE	TRANSPARENT LID	EMBOUT TRANSPARENT	TRANSPARENTER DECKEL



### P873.045 / P873.060 / P873.090

BARRA DE NOTAS DE ALUMINIO / ALUMINIUM CHECK MINDER /  
BARRE PORTE-BONS EN ALUMINIUM / NOTIZLEISTE ALUMINIUM

REF	DESCRIPCIÓN	DESCRIPTION	DESCRIPTION	BESCHREIBUNG
RE873000	BOLAS	BALLS	BOULES	BÄLLE



### P911 / P912 / P913

TABLAS DE CORTE / CUTTING BOARDS /  
PLANCHES À DÉCOUPER / SCHNEIDEBRETTER

REF	DESCRIPCIÓN	DESCRIPTION	DESCRIPTION	BESCHREIBUNG
RE911000	PIÉS	FEET	PIEDS	FÜSSE



### P918.000

LAVA-RACIONADOR ACERO INOXIDABLE / ST/STEEL SCOOP-WASHER /  
RINCE-CUILLÈRES ACIER INOXYDABLE / PORTIONIERERSPÜLE ROSTFREIER STAHL

REF	DESCRIPCIÓN	DESCRIPTION	DESCRIPTION	BESCHREIBUNG
RE918001	GRIFO	TAP	ROBINET	HAHN
RE918002	CUBETA CON 1 AGUJERO	BAC WITH ONE HOLE	BAC AVEC UNE OUVERTURE	BEHÄLTER MIT 1 ABLAUF



### P937.000

MÁQUINA MULTI-USOS / VERSATIL MACHINE /  
MACHINE UNIVERSEL / MULTIFUNKTIONSMASCHINE

REF	DESCRIPCIÓN	DESCRIPTION	DESCRIPTION	BESCHREIBUNG
RE937001	CORTADOR PATATAS	FRENCH FRY CUTTER	COUPE FRITES	KARTOFFELSCHNEIDER
RE937002	CORTADOR MANZANAS	APPLE CUTTER	COUPE POMMES	APFELSCHNEIDER
RE937003	EXPRIMIDOR ZUMOS	JUICER	PRESS FRUITS	SAFTPRESSE



### P945.037

HARINERO / FLOUR BIN /  
TAMIS À FARINE / MEHLSIEB

REF	DESCRIPCIÓN	DESCRIPTION	DESCRIPTION	BESCHREIBUNG
RE945001	CAJÓN	DRAWER	TIROIR	SCHUBLADE

### P945.050 / P945.051

HARINERO / FLOUR BIN /  
TAMIS À FARINE / MEHLSIEB

REF	DESCRIPCIÓN	DESCRIPTION	DESCRIPTION	BESCHREIBUNG
RE945000	CAJÓN	DRAWER	TIROIR	SCHUBLADE





### P954.013 / P954.015

EMBUDO CON FILTRO EXTRAÍBLE / FUNNEL WITH REMOVABLE FILTER /  
ENTONNOIR AVEC FILTRE EXTRACTIBLE / TRICHTER MIT AUSTAUSCHBAREM SIEB

REF	DESCRIPCIÓN	DESCRIPTION	DESCRIPTION	BESCHREIBUNG
RE9541315	FILTRO	FILTER	FILTRE	FILTER

### P954.020 / P954.025

EMBUDO CON FILTRO EXTRAÍBLE / FUNNEL WITH REMOVABLE FILTER /  
ENTONNOIR AVEC FILTRE EXTRACTIBLE / TRICHTER MIT AUSTAUSCHBAREM SIEB

REF	DESCRIPCIÓN	DESCRIPTION	DESCRIPTION	BESCHREIBUNG
RE9542025	FILTRO	FILTER	FILTRE	FILTER

### P964.001

ABRELATAS INDUSTRIAL / CAN OPENER /  
OUVRE-BOÎTES PROFESSIONNEL / INDUSTRIELLER DOSENÖFFNER

REF	DESCRIPCIÓN	DESCRIPTION	DESCRIPTION	BESCHREIBUNG
RE964100	CUCHILLA	KNIFE	COUPEAU	KLINGE
RE964200	RODILLO	WHEEL	ROULEAU	RAD
RE964300	MECANISMO	MECHANISM	MÉCANISME	MESCHANISMUS

### P975.000

CORTADOR DE PATATAS FRITAS / FRENCH FRY CUTTER /  
COUPE FRITES / POMMESCHNEIDER

REF	DESCRIPCIÓN	DESCRIPTION	DESCRIPTION	BESCHREIBUNG
RE975001	CUCHILLA 36 AGUJEROS	KNIFE 36 HOLES	COUPEAU 36 TROUS	SCHNEIDEGITTER 36 LÖCHER
RE975002	CUCHILLA 64 AGUJEROS	KNIFE 64 HOLES	COUPEAU 64 TROUS	SCHNEIDEGITTER 64 LÖCHER

### P999.000

TRÍPODE PAELLERO / BASE FOR BURNER /  
PIED POUR BRÛLEUR / STÄNDER FÜR GASBRENNER

REF	DESCRIPCIÓN	DESCRIPTION	DESCRIPTION	BESCHREIBUNG
RE999000	TAPÓN PLÁSTICO CUADRADO	SQUARE PLASTIC CAP	EMBOUT CARRÉ EN PLASTIQUE	QADRATISCHER PLASTIKSTÖPSEL

### IC70E

TRITURADOR DE HIELO PROFESIONAL / PROFESSIONEL ICE CRUSHER /  
BROYEUR À GLACE PROFESSIONAL / PROFESSIONELLER EISCRUSHER

REF	DESCRIPCIÓN	DESCRIPTION	DESCRIPTION	BESCHREIBUNG
IC70CHUTE	EMBUDO	ICE CHUTE	ENTONNOIR À GLAÇONS	EISTRICHTER
IC70CONT	CONTAINER POLICARBONATO	POLYCARBONATE CONTAINER	BAC À GLACE	BEHÄLTER POLYCARBONAT



## MX1000TXEE / MX1000TPPE

BATIDORA ALTA POTENCIA / HI-POWERBLENDER /  
BLENDER À HAUTE PUISSANCE / HOCHLEISTUNGSMIXER

REF	DESCRIPCIÓN	DESCRIPTION	DESCRIPTION	BESCHREIBUNG
CAC901	JARRA ACERO INOXIDABLE 2 L	STAINLESS STEEL JAR 2 L	BOL EN ACIER INOXYDABLE DE 2 L	BEHÄLTER ROSTFREIER STAHL 2L
CAC931	JARRA COPOLIÉSTER 1,4 L	COPOLYESTER JAR 1,4 L	BOL EN COPOLYESTER DE 1,4 L	BEHÄLTER COPOLYESTER 1,4 L
RE503351	LLAVE DE TUERCA ACOPLAMIENTO	COUPLING WRENCH	BOL EN COPOLYESTER DE 1,4 L CLÉ D'ACOUPLEMENT	KUPPLUNGSSCHRAUBENSCHLÜSSEL



## MX1050TXSEE / MX1050TPSEE

BATIDORA ALTA POTENCIA / HI-POWERBLENDER /  
BLENDER À HAUTE PUISSANCE / HOCHLEISTUNGSMIXER

REF	DESCRIPCIÓN	DESCRIPTION	DESCRIPTION	BESCHREIBUNG
CAC901	JARRA ACERO INOXIDABLE 2 L	STAINLESS STEEL JAR 2 L	BOL EN ACIER INOXYDABLE DE 2 L	BEHÄLTER ROSTFREIER STAHL 2 L
CAC931	JARRA COPOLIÉSTER 1,4 L	COPOLYESTER JAR 1,4 L	BOL EN COPOLYESTER DE 1,4 L	BEHÄLTER COPOLYESTER 1,4 L



## MX1100TXEE / MX1100TXSEE / MX1100TPPE / MX1100TPSEE

BATIDORA ALTA POTENCIA / HI-POWERBLENDER /  
BLENDER À HAUTE PUISSANCE / HOCHLEISTUNGSMIXER

REF	DESCRIPCIÓN	DESCRIPTION	DESCRIPTION	BESCHREIBUNG
CAC901	JARRA ACERO INOXIDABLE 2 L	STAINLESS STEEL JAR 2 L	BOL EN ACIER INOXYDABLE DE 2 L	BEHÄLTER ROSTFREIER STAHL 2 L
CAC931	JARRA COPOLIÉSTER 1,4 L	COPOLYESTER JAR 1,4 L	BOL EN COPOLYESTER DE 1,4 L	BEHÄLTER COPOLYESTER 1,4 L



## MX1200TXEE

BATIDORA ALTA POTENCIA / HI-POWERBLENDER /  
BLENDER À HAUTE PUISSANCE / HOCHLEISTUNGSMIXER

REF	DESCRIPCIÓN	DESCRIPTION	DESCRIPTION	BESCHREIBUNG
CAC901	JARRA ACERO INOXIDABLE 2 L	STAINLESS STEEL JAR 2 L	BOL EN ACIER INOXYDABLE DE 2 L	BEHÄLTER ROSTFREIER STAHL 2 L
CAC931	JARRA COPOLIÉSTER 1,4 L	COPOLYESTER JAR 1,4 L	BOL EN COPOLYESTER DE 1,4 L	BEHÄLTER COPOLYESTER 1,4 L



## MX1300TXEE / MX1300TPPE

BATIDORA ALTA POTENCIA / HI-POWERBLENDER /  
BLENDER À HAUTE PUISSANCE / HOCHLEISTUNGSMIXER

REF	DESCRIPCIÓN	DESCRIPTION	DESCRIPTION	BESCHREIBUNG
CAC901	JARRA ACERO INOXIDABLE 2 L	STAINLESS STEEL JAR 2 L	BOL EN ACIER INOXYDABLE DE 2 L	BEHÄLTER ROSTFREIER STAHL 2 L
CAC931	JARRA COPOLIÉSTER 1,4 L	COPOLYESTER JAR 1,4 L	BOL EN COPOLYESTER DE 1,4 L	BEHÄLTER COPOLYESTER 1,4 L
RE028393	PANEL DE CONTROL	CONTROL PANEL	CONTRÔLE	KONTROLLPLATTE

## MX1500TXEE / MX1500TPPE

BATIDORA ALTA POTENCIA / HI-POWERBLENDER /  
BLENDER À HAUTE PUISSANCE / HOCHLEISTUNGSMIXER

REF	DESCRIPCIÓN	DESCRIPTION	DESCRIPTION	BESCHREIBUNG
CAC901	JARRA ACERO INOXIDABLE 2 L	STAINLESS STEEL JAR 2 L	BOL EN ACIER INOXYDABLE DE 2 L	BEHÄLTER ROSTFREIER STAHL 2 L
CAC931	JARRA COPOLIÉSTER 1,4 L	COPOLYESTER JAR 1,4 L	BOL EN COPOLYESTER DE 1,4 L	BEHÄLTER COPOLYESTER 1,4 L
RE028397	PANEL DE CONTROL	CONTROL PANEL	CONTRÔLE	KONTROLLPLATTE
RE029812	PANEL DE CONTROL	CONTROL PANEL	CONTRÔLE	KONTROLLPLATTE
RE029816	SOFT START PARA PANEL DE CONTROL	SOFT START CONTROL PANEL	SOFT START CONTROL PANEL	SANFTER START KONTROLLPLATTE

ÍNDICE /  
INDEX /  
УКАЗАТЕЛЬ

ARTÍCULO	PÁGINA	ARTÍCULO	PÁGINA
ABRELATAS INDUSTRIAL .....	113	CARRO CON GUIAS, DESMONTABLE .....	214-219
ABRIDOR BOTELLAS .....	150	CARRO CON GUIAS, ENCASTABLE .....	215-216
ABRIDOR DE OSTRAS.....	112	CARRO CON SUPERFÍCIE DE TRABAJO .....	221
AFILADOR DE CUCHILLOS.....	267	CARRO DE MADERA .....	204-207
ALCUZA.....	96	CARRO DE PLÁSTICO .....	208, 222-223
ALFOMBRAS .....	323	CARRO DE SERVICIO DESMONTABLE .....	210
ALU-PRO .....	34-37	CARRO DE SERVICIO EN ALUMINIO.....	208
ANTIALÉRGICO .....	82-87	CARRO DE SERVICIO INOXIDABLE.....	209-211
ANTIMICROBIAL .....	64	CARRO DESCONGELACIÓN .....	217
APARTAMENTO .....	146	CARRO DESEMBARACE .....	208, 211
APLASTACARNES.....	96	CARRO DOBLE PARA BANDEJAS FAST-FOOD.....	219
ARAÑA .....	70	CARRO GASTRONORM DESCONGELACIÓN .....	217
ARMARIO CALIENTE.....	285-286	CARRO GUERIDON .....	206-207
ARO .....	353	CARRO PARA CARGAS PESADAS .....	221
ASADOR GRILL.....	133, 135	CARRO PARA CESTAS .....	222
BALANZA.....	120-121	CARRO PARA PLATOS AJUSTABLE .....	223
BANDA SELLADORA SILICONA .....	170	CARRO PORTA CUBETAS GASTRONORM .....	213-217
BANDEJA.....	54-56, 305-306, 309-311, 319	CARRO PORTACUBIERTOS .....	207, 220, 318
BANDEJA ALUMINIO ANTIADHERENTE .....	54-56	CAZO ALUMINIO.....	37
BANDEJA AUTO-SERVICE ACERO INOX .....	320	CAZO APARTAMENTO.....	146
BANDEJA EXHIBICIÓN .....	309	CAZO BOMBEADO.....	23, 31, 33, 37, 137, 336
BANDEJA FAST-FOOD.....	319	CAZO COOL • LINE .....	139
BANDEJA GASTRONORM.....	54	CAZO HANDY.....	33
BANDEJA ISOTÉRMICA.....	321	CAZO HOBBY CHEF .....	145
BANDEJA PASTELERÍA.....	54-55, 375	CAZO IDEA.....	143
BANDEJA PORTACUBIERTOS.....	320	CAZO INOX-PRO.....	31
BAÑO MARÍA.....	282	CAZO TIPO FRANCÉS .....	22, 31
BARRA DE NOTAS.....	96	CAZOS DE MEDIDAS .....	123
BASE PIZZA.....	57	CAZUELA ALUMINIO FUNDICIÓN .....	134
BATERÍA COCINA 8 PZAS HOBBY CHEF .....	145	CAZUELA BLACK SERIES.....	134
BATERIA COLOR.....	140	CAZUELA PUJADAS 1921 .....	131
BATERÍA IDEA .....	142-143	CEDAZO .....	345
BATIDOR .....	148, 338	CEPILLO.....	97
BATIDORA SOBRE MESA.....	250-251	CESTA GRANDES BANDEJAS .....	196, 202
BATIDORAS DE VASO.....	256-265	CESTA PARA BANDEJAS ISOTÉRMICAS .....	196
BATIDORAS PARA BATIDOS.....	266	CESTA PARA CUBIERTOS.....	191, 193, 202
BLACK SERIES.....	132-135	CESTA UNIVERSAL .....	191, 202
BOL .....	303-306, 311-316, 321	CESTAS ABIERTAS.....	184-187, 192-193
BOQUILLA.....	358-361	CESTAS CERRADAS.....	188-189
BOQUILLA POLICARBONATO.....	361	CESTAS MEDIO TAMAÑO.....	192-193
BRAZOS TRITURADORES.....	253-255	CESTAS PARA PLATOS .....	194-196
CACEROLA ALUMINIO .....	35-36	CESTAS PARA TAZAS.....	190
CACEROLA APARTAMENTO .....	146	CESTILLO PARA CUBIERTOS .....	191
CACEROLA COOL • LINE.....	139	CINTA PVC PARA MOUSSE.....	354
CACEROLA HANDY .....	32-33	CLIP DE IDENTIFICACIÓN.....	196
CACEROLA HOBBY CHEF.....	144	CO-COTTE SILICONA.....	151
CACEROLA IDEA .....	143	COLADOR .....	90-92
CACEROLA INOX-PRO.....	26-27	COLADOR CHINO.....	91
CACEROLA TOP LINE .....	20-21	COLAPASTAS.....	29
CACILLO.....	60-61, 72, 147-148, 315	COLECTIVIDADES .....	318-327
CALDERO.....	336-337	CONJUNTOS COMPLETOS DE ESTANTERIAS .....	231-237
CALENTADOR DE PLATOS .....	287	COOL • LINE.....	138-139
CAMPANA PARA POSTRES .....	344	COPA HELADO .....	332
CARRO BASCULANTE .....	213	CORTADOR / DESCORAZONADOR MANZANAS.....	114-115, 150
CARRO CON GUIAS.....	213-219, 221-222	CORTADOR DE CEBOLLAS.....	107
CARRO CON GUIAS PARA HORNO.....	218	CORTADOR DE LECHUGA .....	106



ARTÍCULO	PÁGINA
CORTADOR DE PATATAS FRITAS	105
CORTADOR DE VERDURAS	248
CORTADOR EN CUBOS	112
CORTADOR QUESOS	112
CORTADOR SECCIONADOR	108
CORTADOR TOMATES	111
CORTADORA DE PEPINOS	105
CORTADORA ELÉCTRICA DE FIAMBRES	248
CORTADOR-REBANADOR	103-104
CORTAHUEVOS	114
CORTAPASTAS	340, 352
CRÊPERA	282
CUBERTERO PARA CARRO SERVICIO	211
CUBETA GASTRONORM SIN BPA	174-175
CUBETAS HELADERÍA	333
CUCHARA	69, 71-72, 147-148, 315, 374
CUCHARA PARA UNTAR	79, 81
CUCHARA SERVICIO	71
CUCHILLA/RODILLO DE RECAMBIO	113
CUECE PASTAS	278
CUSCUSERA	28
DISPENSADOR A PRESIÓN	94-95
DISPENSADOR CON CONTROL DE PORCIONES	347
EMBUDO	95, 346
EMBUDO DOSIFICADOR	346
ESCAMADOR	97
ESCURRIDERA	92
ESPÁTULA	62, 78-81, 147-149, 339
ESPECIEROS	95
ESPUMADERA	62, 70, 147-148
ESTANTERÍAS	224-241
EXPOSITOR DE TARTAS	345
EXPOSITOR GASTRONORM	299-302
EXPRIMIDOR	109, 267
FLANERO	350, 355, 365
FLAP IDENTIFICACIÓN	196
FLAP-RACK®	180-196
FONDOS PERFORADOS GASTRONORM	164, 173, 175, 217
FREIDORA	269-270
FUENTE FONDUE CHOCOLATE	282
FUENTE HONDA CÓNICA	337
FUENTE OVAL	310-311
FUNDA PROTECTORA DE VINILO	223
FUNDAS DESECHABLES POLIETILENO DISPENSADOR	221
GANCHO	93
GASTRONORM FONDO DIFUSOR	171
GASTRONORM INOXIDABLE	162-166, 168, 171
GASTRONORM MELAMINA	295-297, 299-302
GASTRONORM POLICARBONATO	172-173
GASTRONORM POLIPROPILENO	176-177
GEL LUBRICANTE SANITARIO	115
GOFRERAS	283
GRILL	275-277
GUANTES PROTECCIÓN	124-125
HANDY	32-33
HARINERO	92

ARTÍCULO	PÁGINA
HELADERÍA	244-247, 330-333
HERVIDOR DE ARROZ	278
HOBBY CHEF	144-145
HORNOS	280
INOX-PRO	24-31
JARRA DE MEDIDAS	123
LÁMPARA MANTENEDORA	288-289
LAVA-RACIONADOR ACERO INOX	333
LIBRADOR	337
LICUADORAS	267
MANDOLINAS	115
MANGAS PASTELERAS	357
MANOPLA	124-125
MANTECADORA	244-247
MARCADOR DE TARTAS	342
MARCADORES TIZA	327
MARCOS PARA BANDEJAS	55
MELAMINA PRESENTACIÓN	294-317
MESA DE CORTE	118
MICRO-ONDAS	281
MOLDE CAKE	348, 355, 365
MOLDE FORMA CORAZÓN	354
MOLDE FORMA GOTA	354
MOLDE FORMA LÁGRIMA	354
MOLDE HEXAGONAL	354
MOLDE HUEVO	96
MOLDE MEDIA CAÑA	355
MOLDE NIDO	70
MOLDE OVAL	354
MOLDE PARA PIZZA	57
MOLDE SEMIESFÉRICO	355
MOLDES "FLEXIPAN"	368-375
MOLDES DE SILICONA	362-367
MOLDES PASTELERÍA	348-351, 353-354, 362-367, 368-375
MOLDES SILICONA 600 X 400	366-367
MOLINILLO ESPECIAS	268
MULTIMETAL	136-137
OLLA ALUMINIO	35-36
OLLA APARTAMENTO	146
OLLA CON GRIFO	29
OLLA COOL • LINE	138
OLLA HANDY	32
OLLA HOBBY CHEF	144
OLLA IDEA	143
OLLA INOX-PRO	26-27, 29
OLLA TOP LINE	20-21
PAELLERA ACERO ESMALTADO	50
PAELLERA ALUMINIO	45
PAELLERA HOBBY CHEF	144
PAELLERA INOX-PRO	26-27
PAELLERA PUJADAS 1921	131
PAELLERA TOP LINE	20-21
PAELLERA VALENCIANA	50
PAELLERO ESMALTADO GAS	51
PALA CHIPS	77
PALA FAST-FOOD	79-81

ARTÍCULO	PÁGINA
PALA PARA QUESO	150
PALA PASTELES	79, 81, 149
PALA PESCADO	62, 79
PALA PIZZA	58
PALA PRESENTACIÓN	295, 297
PANEL INFORMACIÓN	325
PANERA	315
PAÑO SILICONA	125
PAPEL SILICONADO	58
PARRILLA PLANA CON ASAS ALUMINIO	135
PASAPURÉS	93
PEINE DECORADOR	342
PELADOR PATATAS	150
PELADOR UNIVERSAL	150
PERFILES DIVISORIOS	163
PINCEL	149, 341
PINZA	73-77, 147, 149
PINZA BUFFET	74-75
PINZAS PARA EMPLATAR	73
PISTOLA REPOSTERÍA	357
PIZARRAS	326-327
PLACA ADAPTADORA ANGULAR	169
PLACA CALIENTE	289
PLANCHA ELÉCTRICA	277
PLATOS	304-305, 316, 321
PORCIONADOR APRETABLE	331
PORTA CUBIERTOS	207, 211, 220, 318
POSTE SEPARACIÓN	324-325
PRENSA AJOS	114, 150
PRESENTADOR CUBETAS GN	169, 302
PROCESADOR DE ALIMENTOS	247-252
PROCESADOR VERSÁTIL MANUAL	113
PROCESADORES MANUALES DE ALIMENTOS	103-115
PUJADAS 1921. HIERRO DE FUNDICIÓN	
ULTRALIGERO INDUCCIÓN	130-131
QUEMADOR ELÉCTRICO	344
RACIONADOR DE HELADO	72, 331-332
RALLADOR	88-89, 150
RASQUETA	79-81, 97, 342
REBANADORA DE FRUTAS Y VERDURAS	107
RECIPIENTE PARA SALSAS	314
RECOGEVERDURAS	118
REDCO®	98-115
REJILLAS GN	56
REJILLAS PASTELERÍA	56, 375
RELOJ DE COCINA DIGITAL	121
REMO	97
RODILLO	340-341
RULETA CORTAPIZZAS	79
RUSTIDERA	53, 134-135, 137
SALAMANDRA	278
SARTÉN "LIONESA"	49
SARTÉN ACERO INOXIDABLE	47-48
SARTÉN ALUMINIO	44-46, 146
SARTÉN ALUMINIO FUNDICIÓN	133
SARTÉN BLACK SERIES	133, 135

ARTÍCULO	PÁGINA
SARTÉN CRÊPES	45, 49, 135
SARTÉN HONDA ESMALTADA CON ASAS	50
SARTÉN IDEA	143
SARTÉN MULTIMETAL	137
SARTÉN PARA BLINIS	46
SARTÉN PUJADAS 1921	131
SARTENES	40-50, 131, 133, 137, 143, 145
SAUTEX ALUMINIO	37
SAUTEX HANDY	33
SAUTEX HOBBY CHEF	145
SAUTEX INOX-PRO	30
SAUTEX MULTIMETAL	137
SEPARADOR PARA OLLA CON GRIFO	29
SIERRA DE COCINA	81, 97
SIGNATURE	198-202
SOPLETE COCINA	344
SOPORTE CUCURUCHO	332
SOPORTE MÁRMOL EXHIBICIÓN	297
SOPORTE PARA BANDEJAS PORTACUBIERTOS GN	320
SOPORTE PARA CHINO O EMBUDO	91, 346
SOPORTE PARA MANGAS PASTELERAS	357
SOPORTE PARA PIZZAS	58
SOPORTE PARA TABLAS DE CORTE	169
SOPORTE PRESENTACIÓN PIZARRA-MÁRMOL	297
SOPORTE TAPAS GN	169
SPOODLE®	65-68, 85
SPOODLE® NYLON	68
SUPER PAN 3®	165
TABLA DE CORTE	116-118
TAPA BATERIA	23, 29, 33, 37
TAPA GN	168, 173, 175, 176
TAPA INOX-PRO	29
TAPA PARA CESTA	191
TAPA POLINORM®	168, 173, 175, 176
TAPA TAZA DESAYUNO	321
TAPETE DE SILICONA	58
TAZA	315-316, 321
TENEDOR	69, 81, 97, 147
TERMÓMETRO	121-123
TOP LINE	18-23
TOSTADORA	271-274
TRÍPODE PAELLERO	51
TRITURADOR DE HIELO	268
T-VERSION	182-196
UTENSILIOS MANGO MADERA	80-81
VAPORERA COOL • LINE	139
VAPORERA HOBBY CHEF	145
VAPORERA INOX-PRO	28
VASO	322
VERSATIL MACHINE	109
WOK ACERO	49
WOK BLACK SERIES	133
WOK INOX	48
WOK MULTIMETAL	137
WOK PUJADAS 1921	131

ITEM	PAGE
ADAPTABLE BARS	163
ADJUSTABLE DISH CADDY	223
ALLERGEN-FREE	82-87
ALU-PRO	34-37
ANGLED ADAPTOR PLATE	169
ANTIMICROBIAL	64
APARTAMENTO	146
APPLE CORER	114-115, 150
BAIN MARIE	282
BARRIER	324-325
BASE FOR BURNER	51
BIRD NEST MOULD	70
BLACK SERIES	132-135
BLACK STEEL SPANISH PAELLA PAN	50
BLACKBOARDS	326-327
BLENDERS	256-265
BOILER	336-337
BOTTLE OPENER	150
BOWL	303-306, 311-316, 321
BPA FREE GASTRONORM PAN	174-175
BREAD BASKET	315
BRUSH	97
BRUSH	149, 341
BUTTER SPREADER	79, 81
CAKE DIVIDER	342
CAKE MOULD	348, 355, 365
CAKE SERVER	79, 81, 149
CAKE STAND	345
CAN OPENER	113
CARAMEL CREAM MOULD	350, 355, 365
CARAMELIZER	344
CASSEROLE	134
CASSEROLE BLACK SERIES	134
CASSEROLE PUJADAS 1921	131
CHALKMARKERS	327
CHECK MINDER	96
CHEESE CUTTER	112
CHEESE SLICER	150
CHINESE COLANDER	91
CHIP BAGGER	77
CHOCOLATE FOUNTAIN	282
CLEARING TROLLEY	208, 211
CLIP TAGS	196
CO-COTTE SILICONE	151
COLANDER	90-92
COLANDER	92
COLORED COOKWARE	140
COMPLETE KITS OF SHELVING	231-237
CONFECTIONERY FUNNEL	346
CONICAL SAUCEPAN	23, 31, 33, 37, 137, 336
COOL • LINE	138-139
CORNET STAND	332
COUNTER-TOP DISPENSER	207, 220, 318
COUNTERTOP MIXERS	250-251
COUSCUS SET	28
CRÊPE MAKER	282

ITEM	PAGE
CUBE CUTTER	112
CUCUMBER SLICER	105
CUP	315-316, 321
CUP RACKS	190
CUTLERY BIN	320
CUTLERY DISPENSER FOR SERVING TROLLEY	211
CUTTING BOARD	116-118
CUTTING BOARD TABLE	118
DECORATING COMB	342
DESSERT COVER	344
DICER & SLICER	103-104
DISHES	304-305, 316, 321
DISPLAY PLATE	309
DISPOSABLE COVER	221
DOUBLE COUNTER-TOP CUTLERY DISPENSER GN	320
DOUBLE CUTTER	340, 352
DOUBLE FAST-FOOD TRAY TROLLEY	219
DREGDERS	95
DRINK MIXERS	266
DROP MOULD	354
EGG RING	96
EGG SLICER	114
ELECTRIC SLICING MACHINE	248
ENAMELLED GAS BURNIER	51
ENAMELLED STEEL PAELLA PAN	50
FAST-FOOD TURNER	79-81
FISH SCALER	97
FISH TURNER	62, 79
FLAP IDENTIFICATION	196
FLAP-RACK®	180-196
FLATWARE BASKET	191
FLOUR BIN	92
FOOD-PROCESSORS	247-252
FORK	69, 81, 97, 147
FRENCH FRY CUTTER	105
FRENCH STYLE SAUCEPAN	22, 31
FRUIT & VEGETABLE SLICER	107
FRY PAN "LYONNAISE"	49
FRY PAN ALUMINIUM	44-46, 146
FRY PAN BLACK SERIES	133, 135
FRY PAN BLINIS	46
FRY PAN CAST ALUMINIUM	133
FRY PAN CRÊPE	45, 49, 135
FRY PAN DEEP ENAMELLED WITH HANDLES	50
FRY PAN IDEA	143
FRY PAN MULTIMETAL	137
FRY PAN PUJADAS 1921	131
FRY PAN ST/STEEL	47-48
FRY PANS	40-50, 131, 133, 137, 143, 145
FRYER	269-270
FUNNEL	95, 346
GARLIC PRESS	114, 150
GASTRONORM CONTAINERS (MELAMINE)	295-297, 299-302
GASTRONORM CONTAINERS (POLYCARBONATE)	172-173
GASTRONORM CONTAINERS (POLYPROPYLENE)	176-177
GASTRONORM FOR DEFROST TROLLEY	217

ENGLISH

ITEM	PAGE
GASTRONORM SANDWICH BOTTOM	171
GASTRONORM ST/STEEL	162-166, 168, 171
GASTRONORM STAND	299-302
GLASS	322
GLOVES	124-125
GN TRANSPORT TROLLEY	213-217
GRANITE-SLATE DISPLAYER	297
GRATER	88-89, 150
GRID FOR STOCK POT WITH TAP	29
GRID GN	56
GRID PASTRY	56, 375
GRIGGLE	277
GRILL	133, 135
GRILL	275-277
GRINDER (ELECTRIC)	268
HALF-SIZE RACKS	192-193
HANDY	32-33
HEART RING MOULD	354
HEATING PLATE	289
HEMISPHERICALD MOULD	355
HEXAGON MOULD	354
HOBBY CHEF	144-145
HOOK	93
HOT CUPBOARD	285-286
HOT TRAY WARMER	287
HOT-PLATE WITH HANDLES	135
ICE CREAM CONTAINERS	333
ICE CREAM CUP	332
ICE CREAM SCOOP	72, 331-332
ICE CRUSHER	268
ICE-CREAM CHURN	244-247
ICE-CREAM PARLOUR	244-247, 330-333
IDEA COOKWARE	142-143
INFORMATION SIGN	325
INOX-PRO	24-31
INSTITUTIONS	318-327
ISOTHERMAL TRAY	321
JUICE EXTRACTORS	267
KITCHEN BOW SAW	81, 97
KITCHEN BOWL	337
KITCHEN TIMER ALARM	121
KITCHENWARE SET 8 PCS HOBBY CHEF	145
KNIFE SHARPENER	267
KNIFE / WHEEL (SPARE PART)	113
LADLE	60-61, 72, 147-148, 315
LAMP	288-289
LID FOR BREAKFAST CUP	321
LID FOR COOKWARE	23, 29, 33, 37
LID GN	168, 173, 175, 176
LID INOX-PRO	29
LID RACKS	191
MANDOLINES	115
MANUAL FOOD PROCESSORS	103-115
MARBLE OBLONG DISPLAY PLATE	297
MATS	323
MEASURING CUPS	123

ITEM	PAGE
MEASURING JUG	123
MEAT BEATER	96
MELAMINE FOR PRESENTATION	294-317
MICRO-WAVES	281
MIXING PADDLE	97
MOULDS "FLEXIPAN"	368-375
MULTIMETAL	136-137
NON-STICK SILICONE MAT	58
NYLON SPOODLE®	68
OIL POURER	96
ONION CUTTER	107
OVAL MOULD	354
OVAL SERVING DISH	310-311
OVEN MITT	124-125
OVENS	280
OYSTER OPENER	112
PAELLA PAN ALUMINIUM	45
PAELLA PAN HOBBY CHEF	144
PAELLA PAN INOX-PRO ST/STEEL	26-27
PAELLA PAN PUJADAS 1921	131
PAELLA PAN TOP LINE	20-21
PAN BAND	170
PASTA COLANDER	29
PASTA COOKER	278
PASTRY BAGS	357
PASTRY MOULDS	348-351, 353-354, 362-367, 368-375
PASTRY TORCH	344
PELLER	150
PERFORATED BOTTOMS GASTRONORM	164, 173, 175, 217
PIZZA MOULD	57
PIZZA PAN	57
PIZZA PAN RACK	58
PIZZA PEEL	58
PIZZA WHEEL	79
PLATING TONGS	73
POLINORM® LID	168, 173, 175, 176
POLYCARBONATE TUBE	361
PORTION CONTROL DISPENSER	347
POTATO PEELER	150
POT-GRABBER	125
PRESS CUM ICING	357
PUJADAS 1921. ULTRALIGHT WEIGHT CAST IRON INDUCTION	130-131
PVC RIBBON	354
RACK (BIG TRAYS)	196, 202
RACK (CLOSED SYSTEM)	188-189
RACK (DISHES)	194-196
RACK (FLATWARE)	191, 193, 202
RACK (ISOTHERMAL TRAYS)	196
RACK (OPENED SYSTEM)	184-187, 192-193
RACK (UNIVERSAL)	191, 202
RAMEKIN	314
RECTANGLE FOR BAKING SHEETS	55
REDCO®	98-115
RICE COOKER	278
RING	353



ITEM	PAGE
ROAST PAN.....	53, 134-135, 137
ROLLING PIN .....	340-341
SALAD CUTTER.....	106
SALAMANDER.....	278
SANITARY GEL LUBRICANT.....	115
SAUCE PAN ALUMINIUM .....	37
SAUCE PAN APARTAMENTO.....	146
SAUCE PAN COOL • LINE .....	139
SAUCE PAN HANDY.....	33
SAUCE PAN HOBBY CHEF .....	145
SAUCE PAN IDEA.....	143
SAUCE PAN INOX-PRO ST/STEEL.....	31
SAUCE POT ALUMINIUM.....	35-36
SAUCE POT APARTAMENTO .....	146
SAUCE POT COOL • LINE.....	139
SAUCE POT HANDY .....	32-33
SAUCE POT HOBBY CHEF .....	144
SAUCE POT IDEA .....	143
SAUCE POT ST/STEEL INOX-PRO .....	26-27
SAUCE POT TOP LINE .....	20-21
SAUTÉ PAN ALUMINIUM.....	37
SAUTÉ PAN HANDY .....	33
SAUTÉ PAN HOBBY CHEF.....	145
SAUTÉ PAN INOX-PRO .....	30
SAUTÉ PAN MULTIMETAL.....	137
SCALE.....	120-121
SCOOP .....	337
SCRAPER.....	79-81, 97, 342
SERVING PADDLE.....	295, 297
SHELVING .....	224-241
SIEVES .....	345
SIGNATURE .....	198-202
SILICONE MOULDS.....	362-367
SILICONE MOULDS 600 X 400 .....	366-367
SILICONIZED BAKING PAPERS .....	58
SKIMMER.....	62, 70, 147-148
SPATULA.....	62, 78-81, 147-149, 339
SPOODLE® .....	65-68, 85
SPOON .....	69, 71-72, 147-148, 315, 374
SPOONS.....	71
SQUEEZE DISHER.....	331
SQUEEZER.....	109, 267
SQUEEZE DISPENSER.....	94-95
ST/STEEL SCOOP WASHER .....	333
ST/STEEL SELF-SERVICE TRAY .....	320
STAND FOR CHINESE COLANDER OR FUNN.....	91, 346
STAND FOR CUTTING BOARDS .....	169
STAND FOR GN CONTAINERS .....	169, 302
STAND FOR GN LIDS .....	169
STEAM POT COOL • LINE.....	139
STEAM POT HOBBY CHEF.....	145
STEAM POT INOX-PRO .....	28
STICK BLENDERS.....	253-255
STOCK POT ALUMINIUM .....	35-36
STOCK POT APARTAMENTO.....	146
STOCK POT COOL • LINE .....	138

ITEM	PAGE
STOCK POT HANDY.....	32
STOCK POT HOBBY CHEF .....	144
STOCK POT IDEA.....	143
STOCK POT INOX-PRO .....	26-27, 29
STOCK POT TOP LINE ST/STEEL.....	20-21
STOCK POT WITH TAP .....	29
SUPER PAN 3® .....	165
SUPPORT FOR CUTLERY DISPENSER .....	207, 211, 220, 318
SUPPORT FOR PASTRY BAGS.....	357
TEAR MOULD .....	354
THERMOMETER.....	121-123
TOASTER.....	271-274
TOMATOES SLICER .....	111
TONG.....	73-77, 147, 149
TONG. UTILITY.....	74-75
TOP LINE .....	18-23
TRAY.....	54-56, 305-306, 309-311, 319
TRAY (FAST-FOOD).....	319
TRAY (GASTRONORM) .....	54
TRAY (NON-STICK ALUMINIUM).....	54-56
TRAY (PASTRY) .....	54-55, 375
TRIANGLE CAKE MOULD .....	355
TROLLEY (ALUMINIUM SERVING).....	208
TROLLEY (DEFROST WITH RAIL).....	217
TROLLEY (DISASSEMBLED SERVING TROLLEY) .....	210
TROLLEY (DISASSEMBLED WITH RAIL) .....	214-219
TROLLEY (GUERIDON).....	206-207
TROLLEY (INOX SERVING).....	209-211
TROLLEY (OVEN TRAY) .....	218
TROLLEY (PLASTIC).....	208, 222-223
TROLLEY (RAIL) .....	213-219, 221-222
TROLLEY (STACKABLE).....	215-216
TROLLEY (SWINGING BEAM) .....	213
TROLLEY (WOODEN).....	204-207
TROLLEY FOR DISHWASER RACKS .....	222
TROLLEY FOR HEAVY LOADS.....	221
TROLLEY WITH WORKING TOP.....	221
TUBE.....	358-361
T-VERSION .....	182-196
VEGETABLE CUTTER .....	248
VEGETABLE SCRAPER .....	118
VEGETABLE SIEVE .....	93
VERSATIL MACHINE .....	109
VERSATILE MANUAL PROCESSOR.....	113
VINYL RACK COVER.....	223
WAFFLES MAKER.....	283
WEDGER .....	108
WHISK.....	148, 338
WIRE SKIMMER .....	70
WOK (ST/STEEL) .....	48
WOK BLAC SERIES .....	133
WOK MULTIMETAL.....	137
WOK PUJADAS 1921 .....	131
WOK STEEL .....	49
WOOD HANDLE UTENSILS .....	80-81

FRANÇAIS

ARTICLE	PAGE
AIGUISEUR ÉLECTRIQUE.....	267
ALU-PRO.....	34-37
ANTI ALLERGIQUE.....	82-87
ANTIMICROBIEN.....	64
APARTAMENTO.....	146
APLATISSEUR.....	96
APPAREILS MANUELS DE TRANSFORMATION DES ALIMENTS.....	103-115
ARAIGNÉE.....	70
ARMOIRE CHAUD.....	285-286
ASSIETTES.....	304-305, 316, 321
BAC GASTRONORME SANS BPA.....	174-175
BAIN-MARIE.....	282
BALANCE.....	120-121
BANDE À SILICONE.....	170
BARRE PORTE-BONS.....	96
BARRETES DE COMPOSITION.....	163
BASSINE.....	336-337
BASSINE PÂTISSIÈRE.....	337
BATTERIE À COULEURS.....	140
BATTERIE DE CUISINE 8 PIÈCES HOBBY CHEF.....	145
BATTERIE IDEA.....	142-143
BLACK SERIES.....	132-135
BLENDERS.....	256-265
BOL.....	303-306, 311-316, 321
BROSSE.....	97
BROYEUR À GLACE.....	268
BRÛLER ÉMAILLÉ.....	51
CARAMÉLISER.....	344
CASIER À TASSES.....	190
CASIER DEMI-TAILLE.....	192-193
CASSEROLE ALUMINIUM.....	37
CASSEROLE APARTAMENTO.....	146
CASSEROLE BOMBÉE.....	23, 31, 33, 37, 137, 336
CASSEROLE COOL • LINE.....	139
CASSEROLE FORME FRANÇAISE.....	22, 31
CASSEROLE HANDY.....	33
CASSEROLE HOBBY CHEF.....	145
CASSEROLE IDEA.....	143
CASSEROLE INOX-PRO.....	31
CASSEROLE DOSEUR.....	123
CENTRIFUGEUSES.....	267
CERCLE.....	353
CHARIOT À CHARGES LOURDES.....	221
CHARIOT À DÉGIVRAGE.....	217
CHARIOT À GLISSIÈRES.....	213-219, 221-222
CHARIOT À GLISSIÈRES POUR FOUR.....	218
CHARIOT À GLISSIÈRES, DÉMONTABLE.....	214-219
CHARIOT À GLISSIÈRES, EMBOÎTABLE.....	215-216
CHARIOT À PLASTIQUE.....	208, 222-223
CHARIOT AJUSTABLE.....	223
CHARIOT AVEC PLAN DE TREVALL.....	221
CHARIOT BASCULANTE.....	213
CHARIOT DE DÉBARASSAGE.....	208, 211
CHARIOT DE SERVICE DÉMONTABLE.....	210
CHARIOT DE SERVICE EN ALUMINIUM.....	208

ARTICLE	PAGE
CHARIOT DOUBLE POUR PLATEAUX FAST-FOOD.....	219
CHARIOT EN BOIS.....	204-207
CHARIOT GUERIDON.....	206-207
CHARIOT POUR PANIERS À VAISSELLE.....	222
CHARIOT TRANSPORT BAC GN.....	213-217
CHARIOTS DE SERVICE INOXYDABLE.....	209-211
CHINOIS À GAZE.....	91
CLIP D'IDENTIFICATION.....	196
COCOTTE.....	134
COCOTTE BLACK SERIES.....	134
CO-COTTE SILICONE.....	151
COLLECTIVITÉS.....	318-327
COOL • LINE.....	138-139
CORBEILLE À PAIN.....	315
COUPE À GLACE.....	332
COUPE EN CUBES.....	112
COUPE FRITES.....	105
COUPE FROMAGE.....	112
COUPE TOMATES.....	111
COUPE-CONCOMBRE.....	105
COUPE-LÉGUMES.....	248
COUPE-OEUF.....	114
COUPE-ONIONS.....	107
COUPE-SALADE.....	106
COUP-FRUIT ET LÉGUMES.....	107
COUSCOUSSIER.....	28
COUTEAU / ROULEAU (PIÈCE DE RECHNGE).....	113
COUTEAU À BEURRE.....	79, 81
COUTEUA À BEURRE.....	150
COUVERCLE À DESSERT.....	344
COUVERCLE BATTERIE.....	23, 29, 33, 37
COUVERCLE GN.....	168, 173, 175, 176
COUVERCLE INOX-PRO.....	29
COUVERCLE POLINORM®.....	168, 173, 175, 176
COUVERCLE POUR COUPELLE DESSERT.....	321
COUVERCLE POUR PANIER.....	191
CRÊPIÈRE.....	282
CROCHET.....	93
CUILLÈRE.....	69, 71-72, 147-148, 315, 374
CUILLÈRE À GLACE.....	72, 331-332
CUILLÈRES À SERVIR.....	71
CUISER À PÂTE.....	278
CUISEUR À RIZ.....	278
CUIT-PÂTES.....	29
CUIT-VAPEUR COOL • LINE.....	139
CUIT-VAPEUR HOBBY CHEF.....	145
CUIT-VAPEUR INOX-PRO.....	28
DEMI-SPÉRIQUE.....	355
DISTRIBUTEUR À PRESSION.....	94-95
DISTRIBUTEUR CONTRÔLE DE LA PARTIE.....	347
DIVISEUR.....	108
DOSEUR À PRESSER.....	331
DOUILLE.....	358-361
ECAILEUR.....	97
ECUMOIRE.....	62, 70, 147-148
EGOUTTOIRS POUR BACS GASTRONORME.....	164, 173, 175, 217

ARTICLE	PAGE
ENTONNOIR .....	95, 346
ENTONNOIR DOSEUR .....	346
EPLUCHEUR.....	150
EPLUCHEUR UNIVERSEL .....	150
ETAGÈRES .....	224-241
FAITOUT ALUMINIUM .....	35-36
FAITOUT APARTAMENTO .....	146
FAITOUT COOL • LINE .....	139
FAITOUT HANDY.....	32-33
FAITOUT HOBBY CHEF .....	144
FAITOUT IDEA.....	143
FAITOUT INOX-PRO .....	26-27
FAITOUT PUJADAS 1921.....	131
FAITOUT TOP LINE.....	20-21
FLAP IDENTIFICATION .....	196
FLAP-RACK®.....	180-196
FONTAIN À CHOCOLAT .....	282
FOUET.....	148, 338
FOUR À MICRO-ONDES.....	281
FOURCHETTE.....	69, 81, 97, 147
FOURS .....	280
FRITEUSE .....	269-270
GANT À FOUR.....	124-125
GANTS.....	124-125
GARTRONORME POUR CHARIOT DÉGIVRAGE .....	217
GASTRONORM INOXYDABLE .....	162-166, 168, 171
GASTRONORME (MELAMINE).....	295-297, 299-302
GASTRONORME (POLYCARBONATE) .....	172-173
GASTRONORME (POLYPROPYLENE).....	176-177
GASTRONORME AVEC FOND THERMO-DIFFUSEUR.....	171
GAUFFRIERS .....	283
GEL LUBRIFIANT SANITAIRE.....	115
GLACES.....	244-247, 330-333
GOUSSIÈRE .....	355
GRILL .....	133, 135
GRILL .....	275-277
GRILL PLAT AVEC POIGNÉES .....	135
GRILLE GN .....	56
GRILLE PÂTISSERIE.....	56, 375
GRILLE POUR MARMITE AVEC ROBINET .....	29
HANDY .....	32-33
HOBBY CHEF.....	144-145
HOUSSE JETABLES .....	221
HUILIÈRE.....	96
INOX-PRO .....	24-31
KITS PRÉPARÉS DE ÉTÉGÈRE.....	231-237
LAMPE CHAUFFANTE .....	288-289
LOUCHE.....	60-61, 72, 147-148, 315
MANDOLINES .....	115
MARMITE ALUMINIUM .....	35-36
MARMITE APARTAMENTO.....	146
MARMITE COOL • LINE .....	138
MARMITE HOBBY CHEF .....	144
MARMITE INOX-PRO .....	26-27, 29
MARMITE TOP LINE.....	20-21
MARMITE TRAITEUR AVEC ROBINET.....	29

ARTICLE	PAGE
MARMITE TRAITEUR HANDY.....	32
MARMITE TRAITEUR IDEA .....	143
MARQUEURS.....	327
MELAMINE POUR PRÉSENTATION .....	294-317
MÉLANGEURS DE COMPTOIR .....	250-251
MINUTEUR DE CUISINE.....	121
MIXEURS .....	253-255
MOULE À CAKE .....	348, 355, 365
MOULE À FLAN .....	350, 355, 365
MOULE À NID .....	70
MOULE À OEUF.....	96
MOULE À PIZZA .....	57
MOULE COEUR .....	354
MOULE GOUTTE.....	354
MOULE HEXAGONE .....	354
MOULE LARME .....	354
MOULE OVALE.....	354
MOULES "FLEXIPAN" .....	368-375
MOULES À SILICONE 600 X 400.....	366-367
MOULES DE SILICONE .....	362-367
MOULES PÂTISSERIE .....	348-351, 353-354, 362-367, 368-375
MOULIN À ÉPICES .....	268
MOULIN À LÉGUMES.....	93
MULTIMÉTAL.....	136-137
OUVRE BOUTEILLES .....	150
OUVRE HUÎTRES .....	112
OUVRE-BOÎTES .....	113
PALETTE .....	62, 78-81, 147-149, 339
PALETTE À FISH .....	62, 79
PALETTE FAST-FOOD .....	79-81
PANIER FERMÉES .....	184-187, 192-193
PANIER OUVERTS.....	188-189
PANIER POUR ASSITTES.....	194-196
PANIER POUR COUVERTS .....	191, 193, 202
PANIER POUR PLATEAUX.....	196, 202
PANIER POUR PLATEAUX ISOTHERMES .....	196
PANIER UNIVERSEL .....	191, 202
PANNEAU INFORMATION .....	325
PAPIER SILICONE .....	58
PASSOIRE À POIGNÉES.....	92
PASSOIRE À QUEUE.....	90-92
PEIGNE À DECOR.....	342
PELLE À ENFOURNER .....	58
PELLE À FARINE.....	337
PELLE À FRITES .....	77
PELLE À GÂTEAU.....	79, 81, 149
PELLE À LÉGUMES.....	118
PELLE PRÉSENTATION .....	295, 297
PETIT PANIER POUR LES COUVERTS.....	191
PIED POUR BRÛLEUR.....	51
PINCE .....	73-77, 147, 149
PINCE BUFFET .....	74-75
PINCEAU .....	149, 341
PINCES POUR PRÉSENTATION .....	73
PISTOLET POUR PÂTISSERIE .....	357
PLANCHE À DÉCOUPER .....	116-118

FRANÇAIS

ARTICLE	PAGE
PLAQUE À PÂTISSERIE.....	54-55, 375
PLAQUE À PIZZA.....	57
PLAQUE À RÔTIR.....	53, 134-135, 137
PLAQUE ALUMINIUM ANTI-ADHESIF.....	54-56
PLAQUE CHAUFFANTE.....	289
PLAQUE ÉLECTRIQUE.....	277
PLAQUE GASTRONORME.....	54
PLAQUE INTERMÉDIAIRE INCLINÉE.....	169
PLAT À PAELLA ACIER ÉMAILLÉ.....	50
PLAT À PAELLA ALUMINIUM.....	45
PLAT À PAELLA EN TÔLE ACIER.....	50
PLAT À PAELLA HOBBY CHEF.....	144
PLAT À PAELLA INOX-PRO.....	26-27
PLAT À PAELLA PUJADAS 1921.....	131
PLAT À PAELLA TOP LINE.....	20-21
PLAT OVALE.....	310-311
PLATEAU.....	54-56, 305-306, 309-311, 319
PLATEAU FAST-FOOD.....	319
PLATEAU ISHOTHERMIC.....	321
PLATEAU MARBRES NOIR.....	297
PLATEAU PRÉSENTATION.....	309
PLATEAU SELF-SERVICE ACIER INOX.....	320
POCHES PÂTISSIÈRES.....	357
POÊLE "LYONNAISE".....	49
POÊLE À BLINIS.....	46
POÊLE À CRÊPES.....	45, 49, 135
POÊLE ACIER INOXYDABLE.....	47-48
POÊLE ALUMINIUM.....	44-46, 146
POÊLE ALUMINIUM FONTÉ.....	133
POÊLE BLACK SERIES.....	133, 135
POÊLE HAUTE AVEC ANSES.....	50
POÊLE IDEA.....	143
POÊLE MULTIMÉTAL.....	137
POÊLE PUJADAS 1921.....	131
POÊLES.....	40-50, 131, 133, 137, 143, 145
POLUCARBONATE DOUILLE.....	361
POT MESUREUR.....	123
POTEAU.....	324-325
PRÉSENTOIR BACS GASTRONORME.....	299-302
PRÉSENTOIR DE TARTES.....	345
PRÉSENTOIR GRANITE-ARDOISE.....	297
PRESS FRUITS.....	109, 267
PRESSE-AIL.....	114, 150
PROCESSEUR VERSATILE ET MANUEL.....	113
PROTECTRICE EN VINYLE.....	223
PUJADAS 1921. FONTE ULTRALÉGER INDUCTION.....	130-131
RACLETTE.....	79-81, 97, 342
RAMASSE-COUVERTS.....	320
RAMASSE-COUVERTS POUR CHARIOT SERVICE.....	211
RAMEQUIN.....	314
RÂPE.....	88-89, 150
RÉCHAUD.....	287
RÉCIPIENT À GLACE.....	333
RECTANGLE POUR PLAQUES INOX.....	55
REDCO®.....	98-115
RINCE-CUILLÈRES ACIER INOX.....	333

ARTICLE	PAGE
ROBOT MULTIFUNCTION.....	247-252
ROULEAU.....	340-341
ROULETTE À PÂTES.....	340, 352
ROULETTE À PIZZA.....	79
RUBAN PÂTISSIER.....	354
SALAMANDRE.....	278
SAUPOUDREUSES.....	95
SAUTEUSE ALUMINIUM.....	37
SAUTEUSE HANDY.....	33
SAUTEUSE HOBBY CHEF.....	145
SAUTEUSE INOX-PRO.....	30
SAUTEUSE MULTI-MÉTAL.....	137
SCIE DE CUISINE.....	81, 97
SÉPARATEUR DE PORTIONS.....	342
SHAKER ÉLECTRIQUE.....	266
SIGNATURE.....	198-202
SPATULE GÉANTE.....	97
SPOODLE®.....	65-68, 85
SPOODLE® NYLON.....	68
SUPER PAN 3®.....	165
SUPPORT DOUBLE PORTE-COUVERTS GN.....	320
SUPPORT POUR BACS GN.....	207, 220, 318
SUPPORT POUR BACS GN.....	169, 302
SUPPORT POUR CORNETS.....	332
SUPPORT POUR COUVERCLES GN.....	169
SUPPORT POUR ENTONNOIR OU CHINOIS.....	91, 346
SUPPORT POUR PLANCHES À DÉCOUPER.....	169
SUPPORT POUR PLAQUES À PIZZA.....	58
SUPPORT POUR POUCHES PÂTISSIER.....	357
SUPPORT RAMASSE-COUVERTS.....	207, 211, 220, 318
TABLE À DÉCOUPER.....	118
TABLEAUX.....	326-327
TAMIS.....	345
TAMIS À FARINE.....	92
TAPIS.....	323
TASSE.....	315-316, 321
THERMOMÈTRE.....	121-123
TOASTEUR.....	271-274
TOILE DE CUISSON.....	58
TOP LINE.....	18-23
TORCHE À CARAMÉLISER.....	344
TORCHON EN SILICONE.....	125
TRANCHES ET CUBES.....	103-104
TRANCHEUR ÉLECTRIQUE.....	248
TURBINE À GLACE.....	244-247
T-VERSION.....	182-196
USTENSILES MANCHE EN BOIS.....	80-81
VERRE.....	322
VERSATIL MACHINE.....	109
VIDE / COUPE POMMES.....	114-115, 150
WOK ACIER.....	49
WOK BLACK SERIES.....	133
WOK INOX.....	48
WOK MULTIMÉTAL.....	137
WOK PUJADAS 1921.....	131



ARTIKEL	SEITE
ABRÄUMWAGEN	208, 211
ABSPERRUNG	324-325
ALUMINIUMGUSSPFANNE	133
ALUMINIUMSAUTEUSE	37
ALUMINIUMTOPF	37
ALU-PRO	34-37
ANTI ALLERGIE	82-87
ANTIHAFTBESCHICHTETES ALUMINIUMBLECH	54-56
ANTIMIKROBIOTIKUM	64
APARTAMENT	146
APFELAUSSTECHER	114-115, 150
ARBEITSFLÄCHEN-MIXER	250-251
AUSSTRICHMESSER	79, 81
AUSSTECHEFORMEN	340, 352
AUSSTELLER GASTRONORM	299-302
AUSTERÖFFNER	112
BEHÄLTER FÜR SERVICEWAGEN	211
BESTECKKASTEN	320
BESTECKKASTEN	207, 211, 220, 318
BESTECKKÖRBCHEN	191
BESTECKSPÜLKORB	191, 193, 202
BLACK SERIES	132-135
BLINISPFANNE	46
BRÄTER	53, 134-135, 137
BROTKORB	315
BUFFETZANGE	74-75
COOL • LINE	138-139
COUSCOUSTOPF	28
CREPE-EISEN	282
CREPEPFANNE	45, 49, 135
DAMPFGARER COOL • LINE	139
DAMPFGARER HOBBY CHEF	145
DAMPFGARER INOX-PRO	28
DECKEL FRÜHSTÜCKSTASSE	321
DECKEL FÜR KOCHGESCHIRR	23, 29, 33, 37
DECKEL INOX-PRO	29
DECKEL POLINORM®	168, 173, 175, 176
DECKELGN	168, 173, 175, 176
DEKORATIONSSPACHTEL	342
DESSERTHAUBE	344
DIGITALE KÜCHENUHR	121
DOPPELTER FAST-FOOD TABLETT-TROLLEY	219
DOSIERUNGSTRICHTER	346
DOSSIERKASSEROLLEN	123
DREIECKIGE FORM	355
DREIFUSSTÄNDER FÜR GASBRENNER	51
DRUCKDISPENSER	94-95
EIERSCHNEIDER	114
EIFORM	96
EINSTELLBARER TELLERWAGEN	223
EINWEG-HÜLLEN AUS POLYÄTHYLEN	221
EISCREMEBECHER	332
EISCREMESCHALEN	333
EISCREMEWAFFELSTÄNDER	332
EISCRUSHER	268
EISDIELE	244-247, 330-333

ARTIKEL	SEITE
EISMASCHINE	244-247
EISPORTIONIERER	72, 331-332
EISPORTIONIERER	331
ELEKTRISCHER AUFSCHNITTMASCHINE	248
ELEKTRISCHER BRENNER	344
ELEKTRISCHER GRILL	277
EMAILLIERTE GASPAELLAPFANNE	51
EMAILLIERTE PAELLAPFANNE AUS STAHL	50
FAST-FOOD- SCHAUFEL	79-81
FAST-FOOD-TABLETT	319
FISCHENTSCHUPPER	97
FISCHWENDER	62, 79
FLAP IDENTIFIKATION	196
FLAP-RACK®	180-196
FLASCHENÖFFNER	150
FLEISCHSTAMPFER	96
FORMEN "FLEXIPLAN"	368-375
FRANZÖSISCHER KOCHTOPF INOX-PRO	22, 31
FRITEUSE	269-270
FRITTENHEBER	77
FRITTIERSCHAUFEL	70
GABEL	69, 81, 97, 147
GASTRONORM BEHÄLTER OHNE BPA	174-175
GASTRONORM DIFFUSIONSBODEN	171
GASTRONORM MELAMIN	295-297, 299-302
GASTRONORM POLYKARBONAT	172-173
GASTRONORM POLYPROPYLEN	176-177
GASTRONORM ROSTFREI	162-166, 168, 171
GASTRONORMTABLETT	54
GELOCHTE BÖDEN GASTRONORM	164, 173, 175, 217
GEMÜSEHACKER	118
GEMÜSEHOBEL	115
GEMÜSESCHNEIDER	248
GEMÜSESIEB	93
GETRÄNKEMIXER	266
GEWINKELTE ADAPTERPLATTE	169
GEWÜRZMÜHLE	268
GEWÜRZSTÄNDER	95
GLAS	322
GN TRANSPORTWAGEN	213-217
GRANIT-SCHIEFER PRÄSENTIERPLATTE	297
GRILL	275-277
GRILL	133, 135
GRILLPLATTE MIT GRIFFEN ALUMINIUM	135
GURKENSCHNEIDER	105
HAKEN	93
HALBKUGELFORM	355
HALTER FÜR BESTECKKASTEN GN	320
HALTER FÜR GN DECKEL	169
HALTER FÜR SCHNEIDEBRETTER	169
HALTER FÜR SPRITZBEUTEL	357
HANDY	32-33
HANDY KASSEROLLE	32-33
HANDY STIELKASSEROLLE	33
HANDY STIELKASSEROLLE	33
HANDY TOPF	32

DEUTSCH

ARTIKEL	SEITE
HERDPLATTE	289
HERZFORM	354
HOBBY CHEF	144-145
IDEA KASSEROLLE	143
IDEA KOCHBEDARF	142-143
IDEA STIELKASSEROLLE	143
IDEA TOPF	143
INDUSTRIELLER DOSENÖFFNER	113
INFORMATIONSTAFEL	325
INOX-PRO	24-31
ISOTHERMISCHES TABLETT	321
KÄSE DRAHTSCHNEIDER	112
KÄSEHOBEL	150
KASSEROLLE	134
KASSEROLLE ALUMINIUM	35-36
KASSEROLLE APARTAMENTO	146
KASSEROLLE BLACK SERIES	134
KASSEROLLE COOL • LINE	139
KASSEROLLE COOL • LINE	139
KASSEROLLE HOBBY CHEF	145
KASSEROLLE HOBBY CHEF	144
KASSEROLLE INOX-PRO	26-27
KASSEROLLE PUJADAS 1921	131
KASSEROLLE TOP LINE	20-21
KNOBLAUCHPRESSE	114, 150
KOCHGESCHIRR FARBIG	140
KOCHTOPF INOX-PRO	31
KOLLEKTIVITÄT	318-327
KOMPLETTE REGALSETS	231-237
KONISCHE, TIEFE PLATTE	337
KONISCHER KOCHTOPF	23, 31, 33, 37, 137, 336
KREIDEMARKER	327
KUCHENBACKFORM	348, 355, 365
KÜCHENBEDARF 8-TLG HOBBY CHEF	145
KÜCHENBRENNER	344
KÜCHENMASCHINE	247-252
KÜCHENMASCHINE	109
KÜCHENSÄGE	81, 97
LÖFFEL	69, 71-72, 147-148, 315, 374
LÖFFEL	71
LYONER PFANNE	49
MANUELLE KÜCHENMASCHINEN	103-115
MATTEN	323
MEDIZINISCHES GLEITGEL	115
MEHLSIEB	92
MELAMIN PRÄSENTATION	294-317
MESSBECHER	123
MESSER/RAD (ERSATZTEIL)	113
MESSERSCHÄRFER	267
MIKROWELLE	281
MIXER	256-265
MULTIFUNKTIONSREIBE	113
MULTIMETAL	136-137
NAMENSSCHILDER MIT CLIP	196
NOTIZLEISTE	96
NUDELKOCHER	278

ARTIKEL	SEITE
NUDELSIEB	29
NYLON-SPOODLE®	68
OBSTSCHNEIDER	107
ÖFEN	280
ÖLKANNE	96
OVALE FORM	354
OVALE PLATTE	310-311
PAELLAPFANNE ALUMINIUM	45
PAELLAPFANNE HOBBY CHEF	144
PAELLAPFANNE INOX-PRO	26-27
PAELLAPFANNE PUJADAS 1921	131
PAELLAPFANNE TOP LINE	20-21
PATISSERIEFORMEN	348-351, 353-354, 362-367, 368-375
PATISSERIE-PISTOLE	357
PATISSERIEROST	56, 375
PATISSERIETABLETT	54-55, 375
PFANNE ALUMINIUM	44-46, 146
PFANNE BLACK SERIES	133, 135
PFANNE EDELSTAHL	47-48
PFANNE IDEA	143
PFANNE MULTIMETAL	137
PFANNE PUCHADAS 1921	131
PFANNEN	40-50, 131, 133, 137, 143, 145
PFANNENWENDER	62, 78-81, 147-149, 339
PINSEL	97
PINSEL	149, 341
PIZZAFORM	57
PIZZAMESSER	79
PIZZAPLATTE	57
PIZZAROST	58
PIZZASCHAUFEL	58
POMMES FRITES-SCHNEIDER	105
PORTIONIERER	337
PORTIONSKONTROLLSPENDER	347
PRÄSENTATIONSPLATTE	309
PRÄZISIONSPINZETTE	73
PRESSE	109, 267
PUDDINGFORM	350, 355, 365
PUJADAS 1921. GUSSEISEN ULTRALEICHT INDUKTION	130-131
PVC-BAND FÜR MOUSSE	354
RAHMEN FÜR BACKBLECHE	55
RECHTECKIGE MARMOR-PRÄSENTATIONSPLATTE	297
REDCO®	98-115
REGALE	224-241
REIBE	88-89, 150
REISKOCHER	278
RING	353
ROST GN	56
RÜHRBESEN	148, 338
RÜHRQUIRL	97
RÜHRSCHÜSSEL	336-337
SAFTPRESSE	267
SALAMANDER	278
SALATSCHNEIDER	106
SAUTEUSE HOBBY CHEF	145
SAUTEUSE INOX-PRO	30

ARTIKEL	SEITE
SAUTEUSE MULTIMETAL .....	137
SCHABER .....	79-81, 97, 342
SCHALE .....	303-306, 311-316, 321
SCHAUMLÖFFEL .....	62, 70, 147-148
SCHNEIDEBRETT .....	116-118
SCHNEIDETISCH .....	118
SCHOKOLADENBRUNNEN .....	282
SCHÖPFLÖFFEL .....	60-61, 72, 147-148, 315
SCHUTZHANDSCHUHE .....	124-125
SCHUTZHÜLLE VINYL .....	223
SECHSECKIGE FORM .....	354
SELBSTBEDIENUNGSTABLETT EDELSTAHL .....	320
SEPARIERER FÜR TOPF MIT HAHN .....	29
SERVIERPLATTE .....	295, 297
SERVIERWAGEN (ALUMINIUM) .....	208
SERVIERWAGEN (DEMONTIERBAR) .....	210
SERVIERWAGEN (INOX) .....	209-211
SIEB .....	345
SIEB .....	90-92
SIEB .....	92
SIGNATURE .....	198-202
SILIKON-BAND .....	170
SILIKON-CO-COTTE .....	151
SILIKONFORMEN .....	362-367
SILIKONFORMEN 600 X 400 .....	366-367
SILIKONPAPIER .....	58
SILIKONTUCH .....	125
SILIKONTUCH .....	58
SOSENSCHALE .....	314
SPARSCHÄLER .....	150
SPEZIALKORB IN HALBGRÖßE .....	192-193
SPITZSIEB .....	91
SPOODLE® .....	65-68, 85
SPRITZBEUTEL .....	357
SPÜLBECKEN FÜR PORTIONIERER .....	333
SPÜLKORB (GESCHLOSSENES SYSTEM) .....	188-189
SPÜLKORB (GROSSE TABLETS) .....	196, 202
SPÜLKORB (ISOTHERMISCHE TABLETS) .....	196
SPÜLKORB (OFFENES SYSTEM) .....	184-187, 192-193
SPÜLKORB (TELLER) .....	194-196
SPÜLKORBDECKEL .....	191
STABMIXER .....	253-255
STAHLWOK .....	49
STÄNDER FÜR GN BEHÄLTER .....	169, 302
STÄNDER FÜR SPITZSIEB ODER TRICHTER .....	91, 346
STIELKASSEROLLE APARTAMENTO .....	146
SUPER PAN 3® .....	165
TABLETT .....	54-56, 305-306, 309-311, 319
TAFELN .....	326-327
TASSE .....	315-316, 321
TASSENKÖRBE .....	190
TEIGROLLE .....	340-341
TELLER .....	304-305, 316, 321
TELLERWÄRMER .....	287
THERMOMETER .....	121-123
TIEFE, EMALLIERTE PFANNE MIT GRIFFEN .....	50

ARTIKEL	SEITE
TISCHWÜRFELSCHNEIDER UND - HOBEL .....	103-104
TOASTER .....	271-274
TOMATENSCHNEIDER .....	111
TOP LINE .....	18-23
TOPF ALUMINIUM .....	35-36
TOPF APARTAMENTO .....	146
TOPF COOL • LINE .....	138
TOPF HOBBY CHEF .....	144
TOPF INOX-PRO .....	26-27, 29
TOPF MIT HAHN .....	29
TOPF TOP LINE .....	20-21
TOPFHANDSCHUH .....	124-125
TORTENHEBER .....	79, 81, 149
TORTENSCHNEIDER .....	342
TORTENSTÄNDER .....	345
TRÄNFENFORM .....	354
TRANSPORTWAGE FÜR BESTECKBEHÄLTER .....	207, 220, 318
TRICHTER .....	95, 346
TROLLEY (GUERIDON) .....	206-207
TROPFFENFORM .....	354
TÜLLE .....	358-361
TÜLLE POLYCARBONAT .....	361
T-VERSION .....	182-196
UNIVERSALSCHÄLER .....	150
UNIVERSALSPÜLKORB .....	191, 202
UTENSILIEN MIT HOLZGRIFF .....	80-81
VALENZIANISCHE PAELLAPFANNE .....	50
VERSTELLBARE PROFILE .....	163
VOGELNESTFORM .....	70
WAAGE .....	120-121
WAFFELEISEN .....	283
WAGEN (AUFTAUEN) .....	217
WAGEN (EINSCHÜBE DEMONTIERBAR) .....	214-219
WAGEN (EINSCHÜBE) .....	213-219, 221-222
WAGEN (HOLZ) .....	204-207
WAGEN (KLAPPBAR) .....	213
WAGEN (KUNSTSTOFF) .....	208, 222-223
WAGEN (STAPELBAR) .....	215-216
WAGEN AUFTAUEN .....	217
WAGEN FÜR SCHWERE LASTEN .....	221
WAGEN FÜR SPÜLKORBE .....	222
WAGEN MIT ARBEITSFLÄCHE .....	221
WAGEN MIT EINSCHÜBEN FÜR DEN OFEN .....	218
WÄRMELAMPE .....	288-289
WARMHALTESCHRANK .....	285-286
WASSERBAD .....	282
WEDGER SCHNEIDER .....	108
WOK BLACK SERIES .....	133
WOK INOX .....	48
WOK MULTIMETAL .....	137
WOK PUJADAS 1921 .....	131
WÜRFELSCHNEIDER .....	112
ZANGE .....	73-77, 147, 149
ZWIEBELSCHNEIDER .....	107

PORTUGUÊS

ARTIGO	PÁGINA	ARTIGO	PÁGINA
ABRE-LATAS INDUSTRIAL.....	113	CARRO COM GUIAS, ENCASTRÁVEL.....	215-216
ABRIDOR GARRAFAS.....	150	CARRO COM SUPERFÍCIE DE TRABALHO.....	221
AFIADOR DE FACAS.....	267	CARRO DE MADEIRA.....	204-207
ALMOTOLIA.....	96	CARRO DE PLÁSTICO.....	208, 222-223
ALU-PRO.....	34-37	CARRO DE SERVIÇO DESMONTÁVEL.....	210
APARTAMENTO.....	146	CARRO DE SERVIÇO EM ALUMÍNIO.....	208
APRESENTADOR CUBAS GN.....	169, 302	CARRO DE SERVIÇO INOXIDÁVEL.....	209-211
AQUECEDOR DE PRATOS.....	287	CARRO DESCONGELAÇÃO.....	217
ARANHA.....	70	CARRO DESEMBARAÇO.....	208, 211
ARDÓSIAS.....	326-327	CARRO DUPLO PARA BANDEJAS FAST-FOOD.....	219
ARMÁRIO QUENTE.....	285-286	CARRO GASTRONORM DESCONGELAÇÃO.....	217
ARO.....	353	CARRO GUERIDON.....	206-207
ASSADEIRA.....	53, 134-135, 137	CARRO PARA CARGAS PESADAS.....	221
ASSADOR GRILL.....	133, 135	CARRO PARA CESTOS.....	222
BALANÇA.....	120-121	CARRO PARA PRATOS AJUSTÁVEL.....	223
BANDEJA.....	54-56, 305-306, 309-311, 319	CARRO PORTA-CUBAS GASTRONORM.....	213-217
BANDEJA ALUMÍNIO ANTI-ADERENTE.....	54-56	CARRO PORTA-TALHERES.....	207, 220, 318
BANDEJA EXPOSIÇÃO.....	309	CESTINHO PARA TALHERES.....	191
BANDEJA FAST-FOOD.....	319	CESTO GRANDES BANDEJAS.....	196, 202
BANDEJA GASTRONORM.....	54	CESTO PARA BANDEJAS ISOTÉRMICAS.....	196
BANDEJA ISOTÉRMICA.....	321	CESTO PARA TALHERES.....	191, 193, 202
BANDEJA PASTELARIA.....	54-55, 375	CESTO UNIVERSAL.....	191, 202
BANDEJA PORTA-TALHERES.....	320	CESTOS ABERTOS.....	184-187, 192-193
BANDEJA SELF-SERVICE AÇO INOX.....	320	CESTOS FECHADOS.....	188-189
BANDOLINS.....	115	CESTOS PARA PRATOS.....	194-196
BANHO-MARIA.....	282	CHÁVENA.....	315-316, 321
BARRA DE NOTAS.....	96	COADOR.....	90-92
BASE PIZA.....	57	COADOR CHINÊS.....	91
BATEDEIRAS DE COPO.....	256-265	COADOR DE MASSA.....	29
BATEDEIRAS PARA BATIDOS.....	266	CO-COTTE SILICONE.....	151
BATEDOR.....	148, 338	COLECTIVIDADES.....	318-327
BATERIA COZINHA 8 PEÇAS HOBBY CHEF.....	145	COLHER.....	69, 71-72, 147-148, 315, 374
BATERIA IDEA.....	142-143	COLHER PARA UNTAR.....	79, 81
BLACK SERIES.....	132-135	CONCHA.....	60-61, 72, 147-148, 315
BOLSA PROTECTORA DE VINIL.....	223	CONJUNTO DE TEMPEROS.....	95
BOLSAS REJEITÁVEIS POLIETILENO DISTRIBUIDOR.....	221	CONJUNTOS DE ESTANTES COMPLETOS.....	231-237
BOQUILHA.....	358-361	COOL • LINE.....	138-139
BOQUILHA POLICARBONATO.....	361	COPO.....	322
BRAÇOS TRITURADORES.....	253-255	CORTADOR DE BATATAS FRITAS.....	105
ÇAÇAROLA ALUMÍNIO.....	35-36	CORTADOR DE OVOS.....	114
ÇAÇAROLA APARTAMENTO.....	146	CORTADOR DE VERDURAS.....	248
ÇAÇAROLA COOL • LINE.....	139	CORTADOR TOMATES.....	111
ÇAÇAROLA HANDY.....	32-33	CORTADOR/DESCAROÇADOR MAÇÃS.....	114-115, 150
ÇAÇAROLA HOBBY CHEF.....	144	CORTADORA DE FIAMBRES ELÉCTRICA.....	248
ÇAÇAROLA IDEA.....	143	CORTA-MASSAS.....	340, 352
ÇAÇAROLA INOX-PRO.....	26-27	COZE-MASSAS.....	278
ÇAÇAROLA TOP LINE.....	20-21	CRIVO.....	345
ÇAÇOILA ALUMÍNIO FUNDIÇÃO.....	134	CUBA GASTRONORM SEM BPA.....	174-175
ÇAÇOILA BLACK SERIES.....	134	CUBAS GELATARIA.....	333
ÇAÇOILA PUXADAS 1921.....	131	CUSCUZEIRA.....	28
CALDEIRO.....	336-337	DESCASCADOR BATATAS.....	150
CAMPÂNULA PARA SOBREMESAS.....	344	DESCASCADOR UNIVERSAL.....	150
CARRO BASCULANTE.....	213	DISTRIBUIDOR SOB PRESSÃO.....	94-95
CARRO COM GUIAS.....	213-219, 221-222	ESCAMADOR.....	97
CARRO COM GUIAS PARA FORNO.....	218	ESCORREDOR.....	92
CARRO COM GUIAS, DESMONTÁVEL.....	214-219	ESCOVA.....	97



ARTIGO	PÁGINA
ESCUMADEIRA.....	62, 70, 147-148
ESMAGA-CARNES .....	96
ESPÁTULA .....	62, 78-81, 147-149, 339
ESPREMEDOR.....	109, 267
ESPREMEDOR DE ALHOS.....	114, 150
ESTANTES .....	224-241
EXPOSITOR DE TORTAS.....	345
EXPOSITOR GASTRONORM.....	299-302
FERVEDOR DE ARROZ.....	278
FITA PVC PARA MOUSSE.....	354
FLAP IDENTIFICAÇÃO .....	196
FLAP-RACK®.....	180-196
FORMA DE PUDIM .....	350, 355, 365
FORNOS.....	280
FRITADEIRA.....	269-270
FUNDOS PERFURADOS GASTRONORM .....	164, 173, 175, 217
FUNIL.....	95, 346
FUNIL DOSEADOR .....	346
GANCHO .....	93
GARFO.....	69, 81, 97, 147
GASTRONORM FUNDO DIFUSOR .....	171
GASTRONORM INOXIDÁVEL.....	162-166, 168, 171
GASTRONORM MELAMINA.....	295-297, 299-302
GASTRONORM POLICARBONATO .....	172-173
GASTRONORM POLIPROPILENO .....	176-177
GELATARIA .....	244-247, 330-333
GRAMPO DE IDENTIFICAÇÃO .....	196
GRELHA PLANA COM PEGAS ALUMÍNIO.....	135
GRELHADOR .....	275-277
GRELHAS GN .....	56
GRELHAS PASTELARIA.....	56, 375
HANDY .....	32-33
HOBBY CHEF.....	144-145
INOX-PRO .....	24-31
JARRA DE MEDIÇÃO.....	123
LÂMINA/ROLO SOBRESSALENTE .....	113
LÂMPADA MANTENEDORA.....	288-289
LAVA-RACIONADOR AÇO INOX.....	333
LIQUIDIFICADORES .....	267
LUVA SEM DEDOS.....	124-125
LUVAS PROTECÇÃO.....	124-125
MAÇARICO COZINHA.....	344
MANGAS DE PASTÉIS.....	357
MÁQUINA DE CREPES.....	282
MÁQUINA DE GELADOS .....	244-247
MÁQUINAS DE GOFRES .....	283
MARCADOR DE TORTAS.....	342
MARCADORES GIZ.....	327
MELAMINA APRESENTAÇÃO.....	294-317
MESA DE CORTE.....	118
MICRO-ONDAS.....	281
MOINHO DE FARINHA .....	92
MOINHO ESPECIARIAS.....	268
MOLDE CAKE .....	348, 355, 365
MOLDE FORMA CORAÇÃO .....	354
MOLDE FORMA GOTA.....	354

ARTIGO	PÁGINA
MOLDE FORMA LÁGRIMA .....	354
MOLDE HEXAGONAL .....	354
MOLDE MEIA CANA .....	355
MOLDE NINHO .....	70
MOLDE OVAL.....	354
MOLDE OVO.....	96
MOLDE PARA PIZA.....	57
MOLDE SEMIESFÉRICO .....	355
MOLDES "FLEXIPAN" .....	368-375
MOLDES DE SILICONE .....	362-367
MOLDES PASTELARIA.....	348-351, 353-354, 362-367, 368-375
MOLDES SILICONE 600 X 400 .....	366-367
MULTIMETAL.....	136-137
PÁ.....	337
PÁ APRESENTAÇÃO.....	295, 297
PÁ BATATAS FRITAS.....	77
PÁ FAST-FOOD.....	79-81
PÁ PARA QUEIJO.....	150
PÁ PASTÉIS .....	79, 81, 149
PÁ PEIXE.....	62, 79
PÁ PIZA .....	58
PAINEL INFORMAÇÃO .....	325
PANELA A VAPOR COOL • LINE.....	139
PANELA A VAPOR HOBBY CHEF.....	145
PANELA A VAPOR INOX-PRO.....	28
PANELA ALUMÍNIO.....	35-36
PANELA APARTAMENTO .....	146
PANELA COM TORNEIRA .....	29
PANELA COOL • LINE .....	138
PANELA DE PAELHA ESMALTADA GÁS .....	51
PANELA HANDY.....	32
PANELA HOBBY CHEF .....	144
PANELA IDEA .....	143
PANELA INOX-PRO.....	26-27, 29
PANELA TOP LINE .....	20-21
PANO SILICONE .....	125
PAPEL SILICONIZADO .....	58
PASSADOR DE PURÉS.....	93
PENTE DECORADOR .....	342
PERFIS DIVISÓRIOS.....	163
PINÇA .....	73-77, 147, 149
PINÇA BUFETE .....	74-75
PINÇAS PARA EMPRATAR.....	73
PINCEL .....	149, 341
PISTOLA PASTELARIA .....	357
PLACA DE CORTE .....	116-118
PLACA ELÉCTRICA .....	277
PLACA QUENTE .....	289
PORTA-PÃO .....	315
PORTA-TALHERES.....	207, 211, 220, 318
POSTE SEPARAÇÃO.....	324-325
PRATOS.....	304-305, 316, 321
PROCESSADOR DE ALIMENTOS .....	247-252
PUXADAS 1921. FERRO DE FUNDIÇÃO .....	130-131
ULTRALEVE INDUÇÃO.....	130-131
QUADROS PARA BANDEJAS.....	55

PORTUGUÊS

ARTIGO	PÁGINA
QUEIMADOR ELÉCTRICO	344
RACIONADOR DE GELADO	72, 331-332
RALADOR	88-89, 150
RASPADOR	79-81, 97, 342
RECIPIENTE PARA MOLHOS	314
RECOLHE-VERDURAS	118
REDCO®	98-115
RELÓGIO DE COZINHA DIGITAL	121
REMO	97
ROLETA CORTA-PIZAS	79
ROLO	340-341
SALAMANDRA	278
SAUTEX ALUMÍNIO	37
SAUTEX HANDY	33
SAUTEX HOBBY CHEF	145
SAUTEX INOX-PRO	30
SAUTEX MULTIMETAL	137
SEPARADOR PARA PAINELA COM TORNEIRA	29
SERRA DE COZINHA	81, 97
SERTÃ "LIONESA"	49
SERTÃ AÇO ESMALTADO	50
SERTÃ AÇO INOXIDÁVEL	47-48
SERTÃ ALUMÍNIO	45
SERTÃ ALUMÍNIO	44-46, 146
SERTÃ ALUMÍNIO FUNDIÇÃO	133
SERTÃ BLACK SERIES	133, 135
SERTÃ CREPES	45, 49, 135
SERTÃ FUNDA ESMALTADA COM PEGAS	50
SERTÃ HOBBY CHEF	144
SERTÃ IDEA	143
SERTÃ INOX-PRO	26-27
SERTÃ MULTIMETAL	137
SERTÃ PARA BLINIS	46
SERTÃ PUJADAS 1921	131
SERTÃ PUXADAS 1921	131
SERTÃ TOP LINE	20-21
SERTÃ VALENCIANA	50
SERTÃS	40-50, 131, 133, 137, 143, 145
SIGNATURE	198-202
SPOODLE®	65-68, 85
SUPER PAN 3®	165
SUPORTE APRESENTAÇÃO ARDÓSIA-MÁRMORE	297
SUPORTE CARTUCHO	332
SUPORTE MÁRMORE APRESENTAÇÃO	297
SUPORTE PARA BANDEJAS PORTA-TALHERES GN	320
SUPORTE PARA MANGAS DE PASTÉIS	357
SUPORTE PARA PASSADOR CHINÊS OU FUNIL	91, 346
SUPORTE PARA PIZAS	58
SUPORTE PARA PLACAS DE CORTE	169
SUPORTE TAMPAS GN	169
TABULEIRO DE TALHERES PARA CARRO SERVIÇO	211
TAÇA GELADO	332
TACHO ALUMÍNIO	37
TACHO APARTAMENTO	146
TACHO BOLEADO	23, 31, 33, 37, 137, 336
TACHO COOL • LINE	139

ARTIGO	PÁGINA
TACHO HANDY	33
TACHO HOBBY CHEF	145
TACHO IDEA	143
TACHO INOX-PRO	31
TACHO TIPO FRANCÊS	22, 31
TACHOS DE MEDIÇÃO	123
TAMPA BATERIA	23, 29, 33, 37
TAMPA CHÁVENA PEQUENO-ALMOÇO	321
TAMPA GN	168, 173, 175, 176
TAMPA INOX-PRO	29
TAMPA PARA CESTO	191
TAMPA POLINORM®	168, 173, 175, 176
TAPETE DE SILICONE	58
TAPETES	323
TERMÓMETRO	121-123
TIGELA	303-306, 311-316, 321
TOP LINE	18-23
TORRADEIRA	271-274
TRAVESSA FONDUE CHOCOLATE	282
TRAVESSA FUNDA CÓNICA	337
TRAVESSA OVAL	310-311
TRIPÉ PAINELA DE PAELHA	51
TRITURADOR DE GELO	268
T-VERSION	182-196
UTENSÍLIOS CABO MADEIRA	80-81
VERSATIL MACHINE	109
WOK AÇO	49
WOK BLACK SERIES	133
WOK INOX	48
WOK MULTIMETAL	137
WOK PUXADAS 1921	131

Артикул	Страница
COOL • LINE	138-139
GASTRONORM МЕЛАМИНОВАЯ ПОСУДА	295-297, 299-302
REDCO®	98-115
SIGNATURE	198-202
SPOODLE®	65-68, 85
SUPER PAN 3®	165
T-VERSION	182-196
АЛЮМИНИЕВЫЙ ПОДНОС С ПРОТИВОПРИГАРНЫМ ПОКРЫТИЕМ	54-56
БАРЬЕРНЫЕ СТОЛБИКИ	324-325
БЛЕНДЕРЫ	267
БЛЕНДЕРЫ ДЛЯ КОКТЕЙЛЕЙ	266
БЛЕНДЕРЫ КУВШИННЫЕ	256-265
БЛЕНДЕРЫ ПОГРУЖНЫЕ	253-255
БЛИННИЦА	282
БРУС ДЛЯ ЗАМЕТОК	96
ВЕНЧИК	148, 338
ВЕСЛО	97
ВЕСЫ	120-121
ВИЛКА	69, 81, 97, 147
ВИТРИНА GASTRONORM	299-302
ВОРОНКА	95, 346
ВОРОНКА С ДОЗАТОРОМ	346
ГАЗОВАЯ ГОРЕЛКА	344
ГАСТРОЕМКОСТЬ GASTRONORM, БЕЗ ДФП	174-175
ГАСТРОЕМКОСТЬ ИЗ НЕРЖ. СТАЛИ	333
ГОРЯЧАЯ ПЛИТА	289
ГОФРЕНИЦА	283
ГРИЛЬ	275-277
ГРИЛЬ САЛАМАНДРА	278
ДЕЛИТЕЛЬ ДЛЯ ТОРТА	342
ДЕРЖАТЕЛИ ДЛЯ КОНДИТЕРСКИХ МЕШКОВ	357
ДЕРЖАТЕЛЬ ДЛЯ КИТАЙСКОГО ДУРШЛАГА ИЛИ ВОРОНКИ	91, 346
ДЕРЖАТЕЛЬ ДЛЯ КОНУСНОГО СТАКАНЧИКА	332
ДЕРЖАТЕЛЬ ДЛЯ ПОДНОСОВ С ПРИБОРАМИ GN	320
ДЕРЖАТЕЛЬ ДЛЯ РАЗДЕЛОЧНЫХ ДОСОК	169
ДИСПЕНСЕР ПОД ДАВЛЕНИЕМ	94-95
ДИСПЕНСЕР С ОДНОРАЗОВЫМИ ПОЛИЭТИЛЕНОВЫМИ ЧЕХЛАМИ	221
ДОСКА РАЗДЕЛОЧНАЯ	116-118
ДОСКИ	326-327
ДУРШЛАГ	90-92
ДУРШЛАГ	92
ДУРШЛАГ ДЛЯ МАКАРОННЫХ ИЗДЕЛИЙ	29
ДУХОВЫЕ ШКАФЫ	280
ЖАРОВНЯ-ГРИЛЬ	133, 135
ЗАЩИТНЫЕ ПЕРЧАТКИ	124-125
ЗАЩИТНЫЙ ВИНИЛОВЫЙ ЧЕХОЛ	223
ИДЕНТИФИКАЦИОННЫЙ ЗНАЧЕК	196
ИДЕНТИФИКАЦИОННЫЙ КЛИП	196
ИЗМЕЛЬЧИТЕЛЬ ДЛЯ СПЕЦИЙ	268
ИЗМЕЛЬЧИТЕЛЬ ЛЬДА	268
ИНВЕНТАРЬ С ДЕРЕВЯННЫМИ РУЧКАМИ	80-81
ИНФОРМАЦИОННОЕ ТАБЛО	325
КАСТРЮЛЬКА	60-61, 72, 147-148, 315
КАСТРЮЛЯ APARTAMENTO	146
КАСТРЮЛЯ COOL • LINE	139
КАСТРЮЛЯ HANDY	32-33

Артикул	Страница
КАСТРЮЛЯ HOBBY CHEF	144
КАСТРЮЛЯ IDEA	143
КАСТРЮЛЯ INOX-PRO	26-27
КАСТРЮЛЯ PUJADAS 1921	131
КАСТРЮЛЯ TOP LINE	20-21
КАСТРЮЛЯ АЛЮМИНИЕВАЯ	35-36
КАСТРЮЛЯ ВОК PUJADAS 1921	131
КАСТРЮЛЯ ВОК MULTIMETAL	137
КАСТРЮЛЯ ВОК ИЗ НЕРЖАВЕЮЩЕЙ СТАЛИ	48
КАСТРЮЛЯ ВОК ИЗ СТАЛИ	49
КАСТРЮЛЯ ВОК СЕРИИ BLACK	133
КАСТРЮЛЯ ГЛУБОКАЯ	26-27, 29
КАСТРЮЛЯ ГЛУБОКАЯ APARTAMENTO	146
КАСТРЮЛЯ ГЛУБОКАЯ COOL • LINE	138
КАСТРЮЛЯ ГЛУБОКАЯ HANDY	32
КАСТРЮЛЯ ГЛУБОКАЯ HOBBY CHEF	144
КАСТРЮЛЯ ГЛУБОКАЯ IDEA	143
КАСТРЮЛЯ ГЛУБОКАЯ TOP LINE	20-21
КАСТРЮЛЯ ГЛУБОКАЯ АЛЮМИНИЕВАЯ	35-36
КАСТРЮЛЯ ДЛЯ КУС-КУСА	28
КАСТРЮЛЯ ДЛЯ МАКАРОННЫХ ИЗДЕЛИЙ	278
КАСТРЮЛЯ ИЗ ЛИТОГО АЛЮМИНИЯ	134
КАСТРЮЛЯ ПАРОВАРКА ИЗ НЕРЖАВЕЮЩЕЙ СТАЛИ	28
КАСТРЮЛЯ ПАЗЛЯ HOBBY CHEF	144
КАСТРЮЛЯ ПАЗЛЯ INOX-PRO	26-27
КАСТРЮЛЯ ПАЗЛЯ PUJADAS 1921	131
КАСТРЮЛЯ ПАЗЛЯ TOP LINE	20-21
КАСТРЮЛЯ ПАЗЛЯ АЛЮМИНИЕВАЯ	45
КАСТРЮЛЯ ПАЗЛЯ ВАЛЕНСИЙСКАЯ	50
КАСТРЮЛЯ ПАЗЛЯ ИЗ СТАЛИ, ЭМАЛИРОВАННАЯ	50
КАСТРЮЛЯ ПАЗЛЯ, ЭМАЛИРОВАННАЯ, ДЛЯ ГАЗОВОЙ ПЛИТЫ	51
КАСТРЮЛЯ С КРАНОМ	29
КАСТРЮЛЯ СЕРИИ BLACK	134
КАСТРЮЛЯ-СОУСНИК APARTAMENTO	146
КАСТРЮЛЯ-СОУСНИК ИЗ НЕРЖАВЕЮЩЕЙ СТАЛИ	31
КАСТРЮЛЯ-СОУСНИК КОНИЧЕСКИЙ	23, 31, 33, 37, 137, 336
КАСТРЮЛЯ-СОУСНИК ФРАНЦУЗСКОГО ТИПА	22, 31
КИСТОЧКА	149, 341
КИТАЙСКИЙ ДУРШЛАГ	91
КОВРИКИ	323
КОЛОКОЛ ДЛЯ ДЕСЕРТОВ	344
КОЛЬЦО	353
КОНТЕЙНЕР ДЛЯ МУКИ	92
КОНТЕЙНЕР ДЛЯ ПРИБОРОВ	207, 211, 220, 318
КОРЗИНА ДЛЯ БОЛЬШИХ ПОДНОСОВ	196, 202
КОРЗИНА ДЛЯ ИЗОТЕРМИЧЕСКИХ ПОДНОСОВ	196
КОРЗИНКА ДЛЯ ПРИБОРОВ	191, 193, 202
КОРЗИНКА ДЛЯ ПРИБОРОВ	191
КОРЗИНЫ ДЛЯ ТАРЕЛОК	194-196
КОРЗИНЫ ЗАКРЫТЫЕ	188-189
КОРЗИНЫ ОТКРЫТЫЕ	184-187, 192-193
КОТЕЛ	336-337
КРЫШКА GN	168, 173, 175, 176
КРЫШКА POLINORM®	168, 173, 175, 176
КРЫШКА ДЛЯ КАСТРЮЛЬ	23, 29, 33, 37
КРЫШКА ДЛЯ КОРЗИНЫ	191

Артикул	Страница
КРЫШКА ИЗ НЕРЖАВЕЮЩЕЙ СТАЛИ	29
КРЫШКА НА ЧАШКУ ДЛЯ ЗАВТРАКА	321
КРЮЧОК	93
КУХОННЫЙ НАБОР ИЗ 8-МИ ПРЕДМЕТОВ NOBBY CHEF	145
КУХОННЫЙ ПРОЦЕССОР	247-252
ЛАМПА ПОДОГРЕВА	288-289
ЛЕЙКА ДЛЯ МАСЛА	96
ЛЕНТА КОНДИТЕРСКАЯ ИЗ ПВХ ДЛЯ МУССА	354
ЛОЖКА	69, 71-72, 147-148, 315, 374
ЛОЖКА ДЛЯ СМАЗКИ	79, 81
ЛОПАТКА ДЛЯ КАРТОФЕЛЬНЫХ ЧИПСОВ	77
ЛОПАТКА ДЛЯ ПИЦЦЫ	58
ЛОПАТКА ДЛЯ РЫБЫ	62, 79
ЛОПАТКА ДЛЯ СБОРА ОВОЩЕЙ	118
ЛОПАТКА ДЛЯ СЫРА	150
ЛОПАТКА ДЛЯ ТОРТОВ	79, 81, 149
ЛОПАТКА ДЛЯ ФАСТ-ФУДА	79-81
ЛОПАТКА	62, 78-81, 147-149, 339
ЛОТКИ ДЛЯ МОРОЖЕНОГО	333
МАНДОЛИНЫ	115
МАШИНА "VERSATIL MACHINE"	109
МАШИНА ДЛЯ ВЫЖИМАНИЯ	109, 267
МЕЛАМИНОВАЯ ПОСУДА ДЛЯ ПРЕЗЕНТАЦИИ	294-317
МЕЛКИ ДЛЯ ОТМЕТОК	327
МЕНЗУРКА	123
МЕРНЫЕ ЛОЖКИ	123
МЕШКИ КОНДИТЕРСКИЕ	357
МИКРОВОЛНОВАЯ ПЕЧЬ	281
МИСКА КОНИЧЕСКАЯ	337
МОРОЖЕНИЦА	244-247
МОРОЖЕНОЕ	244-247, 330-333
МРАМОРНАЯ ПОДСТАВКА ДЛЯ ПРЕЗЕНТАЦИИ	297
НАБОР КАСТРЮЛЬ IDEA	142-143
НАБОРЫ ДЛЯ СПЕЦИЙ	95
НАСАДКА	358-361
НАСАДКА ИЗ ПОЛИКАРБОНАТА	361
НОЖ / ЗАПАСНОЙ ВАЛИК	113
НОЖ ДЛЯ НАРЕЗКИ КАРТОФЕЛЯ ФРИ	105
НОЖ ДЛЯ НАРЕЗКИ ОВОЩЕЙ	248
НОЖ ДЛЯ РЕЗКИ ТОМАТОВ	111
НОЖ ДЛЯ РЕЗКИ ЯБЛОК И ВЫЕМКИ СЕРДЦЕВИНЫ	114-115, 150
НОЖ ДЛЯ РЕЗКИ ЯИЦ	114
НОЖ ДЛЯ ЧИСТКИ КАРТОФЕЛЯ	150
ОВАЛЬНОЕ БЛЮДО	310-311
ОСНОВА ДЛЯ ПИЦЦЫ	57
ОТКРЫВАЛКА ПРОМЫШЛЕННАЯ	113
ПАРОВАРКА	282
ПАРОВАРКА COOL • LINE	139
ПАРОВАРКА NOBBY CHEF	145
ПЕРФОРИРОВАННОЕ ДНО GASTRONORM	164, 173, 175, 217
ПИАЛА	303-306, 311-316, 321
ПИЛА КУХОННАЯ	81, 97
ПИСТОЛЕТ КОНДИТЕРСКИЙ	357
ПЛОСКАЯ СКОВОРОДА-ГРИЛЬ С АЛЮМИНИЕВЫМИ РУЧКАМИ	135
ПОДНОС	54-56, 305-306, 309-311, 319
ПОДНОС GASTRONORM	54

Артикул	Страница
ПОДНОС ДЛЯ ПРЕЗЕНТАЦИИ	309
ПОДНОС ДЛЯ ПРИБОРОВ	320
ПОДНОС ДЛЯ СЕМИОБСЛУЖИВАНИЯ ИЗ НЕРЖ. СТАЛИ	320
ПОДНОС ИЗОТЕРМИЧЕСКИЙ	321
ПОДНОС КОНДИТЕРСКИЙ	54-55, 375
ПОДНОС ФАСТ-ФУД	319
ПОДОГРЕВАТЕЛЬ ТАРЕЛОК	287
ПОДСТАВКА ДЛЯ КРЫШЕК GN	169
ПОДСТАВКА ДЛЯ ПИЦЦЫ	58
ПОДСТАВКА ДЛЯ ТОРТА	345
ПОЛКИ	224-241
ПОРЦИОННАЯ ЛОЖКА ДЛЯ МОРОЖЕНОГО	72, 331-332
ПРЕЗЕНТАЦИОННАЯ ЛОПАТКА	295, 297
ПРЕСС ДЛЯ ЧЕСНОКА	114, 150
ПЮРЕШНИЦА	93
РАЗДЕЛИТЕЛЬ ДЛЯ КАСТРЮЛИ С КРАНОМ	29
РАЗДЕЛИТЕЛЬНЫЕ ПРОФИЛИ	163
РАМКИ ДЛЯ ПОДНОСОВ	55
РЕГУЛИРУЕМАЯ ТЕЛЕЖКА ДЛЯ ТАРЕЛОК	223
РЕШЕТКИ GN	56
РЕШЕТКИ КОНДИТЕРСКИЕ	56, 375
РИСОВАРКА	278
РОЛИК ДЛЯ НАРЕЗКИ ПИЦЦЫ	79
РУКАВИЦА	124-125
СЕРИИ BLACK	132-135
СЕРИЯ GASTRONORM ИЗ ПОЛИКАРБОНАТА	172-173
СЕРИЯ GASTRONORM С УТОЛЩЕННЫМ ДНОМ СЭНДВИЧ	171
СЕРИЯ ALU-PRO	34-37
СЕРИЯ APARTAMENTO	146
СЕРИЯ FLAP-RACK®	180-196
СЕРИЯ GASTRONORM ИЗ ПОЛИПРОПИЛЕНА	176-177
СЕРИЯ GASTRONORM, НЕРЖ. СТАЛЬ	162-166, 168, 171
СЕРИЯ HANDY	32-33
СЕРИЯ NOBBY CHEF	144-145
СЕРИЯ INOX-PRO	24-31
СЕРИЯ MULTIMETAL	136-137
СЕРИЯ PUJADAS 1921. ЧУГУН С ВЕРХЛЕГКИМ ДЛЯ И ИДУКЦИОННЫХ ПЛИТ	130-131
СЕРИЯ TOP LINE	18-23
СИЛИКОНОВАЯ БУМАГА	58
СИЛИКОНОВАЯ КАСТРЮЛЬКА СО-СОТТЕ	151
СИЛИКОНОВАЯ САЛФЕТКА	125
СИЛИКОНОВАЯ САЛФЕТКА	58
СИТО	345
СКАЛКА ДЛЯ ТЕСТА	340-341
СКОВОРОДА "LYONNAISE"	49
СКОВОРОДА IDEA	143
СКОВОРОДА MULTIMETAL	137
СКОВОРОДА PUJADAS 1921	131
СКОВОРОДА АЛЮМИНИЕВАЯ	44-46, 146
СКОВОРОДА АЛЮМИНИЕВАЯ	133
СКОВОРОДА ГЛУБОКАЯ, ЭМАЛИРОВАННАЯ, С РУЧКАМИ	50
СКОВОРОДА ГРИЛЬ	53, 134-135, 137
СКОВОРОДА ДЛЯ БЛИНОВ	46
СКОВОРОДА ДЛЯ ФРАНЦУЗСКИХ БЛИНОВ	45, 49, 135
СКОВОРОДА СЕРИИ BLACK	133, 135



Артикул	Страница
СКОВОРОДА, НЕРЖ. СТАЛЬ.....	47-48
СКОВОРОДЫ.....	40-50, 131, 133, 137, 143, 145
СКРЕБОК.....	79-81, 97, 342
СКРЕБОК ДЕКОРАТИВНЫЙ.....	342
СКРЕБОК ДЛЯ ЧИСТКИ РЫБЫ.....	97
СЛАНЦЕВО-МРАМОРНАЯ ПОДСТАВКА ДЛЯ ПРЕЗЕНТАЦИИ.....	297
СОВОК.....	337
СОСУД ДЛЯ СОУСОВ.....	314
СОТЕЙНИК HANDY.....	33
СОТЕЙНИК NOBВU CHEF.....	145
СОТЕЙНИК MULTIMETAL.....	137
СОТЕЙНИК АЛЮМИНИЕВЫЙ.....	37
СОТЕЙНИК ИЗ НЕРЖАВЕЮЩЕЙ СТАЛИ.....	30
СОУСНИК COOL • LINE.....	139
СОУСНИК HANDY.....	33
СОУСНИК NOBВU CHEF.....	145
СОУСНИК IDEA.....	143
СОУСНИК АЛЮМИНИЕВАЯ.....	37
СТАКАН.....	322
СТЕНД ДЛЯ ГАСТРОЕМКОСТЕЙ GN.....	169, 302
СТОЛ ДЛЯ НАРЕЗКИ.....	118
ТАРЕЛКИ.....	304-305, 316, 321
ТЕЛЕЖКА GUERIDON.....	206-207
ТЕЛЕЖКА ДВОЙНАЯ ДЛЯ ПОДНОСОВ ФАСТ-ФУД.....	219
ТЕЛЕЖКА ДЕРЕВЯННАЯ.....	204-207
ТЕЛЕЖКА ДЛЯ ГАСТРОЕМКОСТЕЙ GASTRONORM.....	213-217
ТЕЛЕЖКА ДЛЯ КОРЗИНОК.....	222
ТЕЛЕЖКА ДЛЯ ПРИБОРОВ.....	207, 220, 318
ТЕЛЕЖКА ДЛЯ РАЗМОРАЖИВАНИЯ.....	217
ТЕЛЕЖКА ДЛЯ РАЗМОРАЖИВАНИЯ GASTRONORM.....	217
ТЕЛЕЖКА ДЛЯ СБОРА ПОСУДЫ.....	208, 211
ТЕЛЕЖКА ДЛЯ ТЯЖЕЛЫХ ГРУЗОВ.....	221
ТЕЛЕЖКА ОПРОКИДНАЯ.....	213
ТЕЛЕЖКА ПЛАСТМАССОВАЯ.....	208, 222-223
ТЕЛЕЖКА С НАПРАВЛЯЮЩИМИ.....	213-219, 221-222
ТЕЛЕЖКА С НАПРАВЛЯЮЩИМИ ДЛЯ ДУХОВКИ.....	218
ТЕЛЕЖКА С НАПРАВЛЯЮЩИМИ, РАЗБОРНАЯ.....	214-219
ТЕЛЕЖКА С РАБОЧЕЙ ПОВЕРХНОСТЬЮ.....	221
ТЕЛЕЖКА СЕРВИРОВОЧНАЯ АЛЮМИНИЕВАЯ.....	208
ТЕЛЕЖКА СЕРВИРОВОЧНАЯ ИЗ НЕРЖ. СТАЛИ.....	209-211
ТЕЛЕЖКА СЕРВИРОВОЧНАЯ РАЗБОРНАЯ.....	210
ТЕЛЕЖКА ШПИЛЬКА.....	215-216
ТЕПЛОЙ ШКАФ.....	285-286
ТЕРКА.....	88-89, 150
ТЕРМОМЕТР.....	121-123
ТОСТЕР.....	271-274
ТОЧИЛО ДЛЯ НОЖЕЙ.....	267
ТРЕНОЖНИК ДЛЯ КАСТРЮЛИ ПАЭЛЬЯ.....	51
ТЯПКА ДЛЯ ОТБИВАНИЯ МЯСА.....	96
УКОМПЛЕКТОВАННЫЕ НАБОРЫ ПОЛОК.....	231-237
УНИВЕРСАЛЬНАЯ КОНЗИНКА.....	191, 202
УНИВЕРСАЛЬНЫЙ НОЖ ДЛЯ ЧИСТКИ.....	150
УЧРЕЖДЕНИЯ.....	318-327
ФОНТАН ДЛЯ ШОКОЛАДНОГО ФОНДЮ.....	282
ФОРМА ГНЕЗДО.....	70
ФОРМА ДЛЯ ВЫПЕЧКИ "СЛЕЗА".....	354

Артикул	Страница
ФОРМА ДЛЯ ВЫПЕЧКИ "КАПЛЯ".....	354
ФОРМА ДЛЯ ВЫПЕЧКИ "КЕЙК".....	348, 355, 365
ФОРМА ДЛЯ ВЫПЕЧКИ "СЕРДЦЕ".....	354
ФОРМА ДЛЯ ВЫПЕЧКИ ОВАЛЬНАЯ.....	354
ФОРМА ДЛЯ ВЫПЕЧКИ ПОЛУСФЕРА.....	355
ФОРМА ДЛЯ ВЫПЕЧКИ ШЕСТИУГОЛЬНАЯ.....	354
ФОРМА ДЛЯ ПИЦЦЫ.....	57
ФОРМА ДЛЯ РУЛЕТА.....	355
ФОРМА ДЛЯ ЯЙЦА.....	96
ФОРМА-СТАКАНЧИК ДЛЯ ФЛАНА.....	350, 355, 365
ФОРМЫ ДЛЯ ВЫПЕЧКИ "FLEXIPAN".....	368-375
ФОРМЫ ДЛЯ ВЫПЕЧКИ СИЛИКОНОВЫЕ.....	362-367
ФОРМЫ ДЛЯ ВЫРЕЗАНИЯ ТЕСТА.....	340, 352
ФОРМЫ КОНДИТЕРСКИЕ.....	348-351, 353-354, 362-367, 368-375
ФОРМЫ СИЛИКОНОВЫЕ 600 X 400.....	366-367
ФРИТЮРНИЦА.....	269-270
ХЛЕБНИЦА.....	315
ЦИФРОВЫЕ КУХОННЫЕ ЧАСЫ.....	121
ЧАША.....	315-316, 321
ЧАША ДЛЯ МОРОЖЕНОГО.....	332
ШТОПОР.....	150
ШУМОВКА.....	62, 70, 147-148
ШУМОВКА СЕТЧАТАЯ.....	70
ЩЕТКА.....	97
ЩИПЦЫ.....	73-77, 147, 149
ЩИПЦЫ ДЛЯ БУФЕТА.....	74-75
ЩИПЦЫ СЕРВИРОВОЧНЫЕ.....	73
ЭЛЕКТРИЧЕСКАЯ ЛАМПА.....	344
ЭЛЕКТРИЧЕСКИЙ ГЛИЛЬ.....	277
ЭЛЕКТРИЧЕСКИЙ СЛАЙСЕР ДЛЯ КОЛБАСНЫХ ИЗДЕЛИЙ.....	248
ЯЩИК ДЛЯ ПРИБОРОВ ДЛЯ СЕРВИРОВОЧНОЙ ТЕЛЕЖКИ.....	211

REF.	Pag.	REF.	Pag.	REF.	Pag.	REF.	Pag.	REF.	Pag.	REF.	Pag.
306	108	15073	104	47156	331	52713	200	52832	201	90182	165
308	108	15076	104	47157	331	52714	201	52844	201	90202	165
336	108	15078	104	47158	331	52715	201	52845	201	90212	165
338	108	15081	104	47159	331	52716	201	52846	201	90222	165
434	106	15082	104	47160	331	52717	201	52847	201	90242	165
435	106	15083	104	47161	331	52718	200	52848	201	90252	165
485	106	15085	104	47169	331	52719	200	52849	201	90262	165
485	107	15086	104	47170	331	52720	200	55000	103	90282	165
509	107	15103	111	47171	331	52721	200	55001	103	90302	166
510	107	15104	111	47172	331	52722	201	55002	103	90312	166
511	107	15105	111	47200	331	52723	201	55010	105	90322	166
512	107	15113	111	47245	331	52724	201	55011	103	90342	166
0653	111	15114	111	47246	331	52725	201	55025	105	90352	166
0654	111	15115	111	47247	331	52726	199	55028	105	90362	166
704	108	15149	115	47248	331	52727	199	55059	103	90382	166
706	108	15153	103	47274	330	52728	199	55060	103	90402	166
708	108	15155	103	47275	330	52729	199	55061	103	90412	166
712	108	15205	111	47276	330	52730	199	55062	103	90422	166
1400	115	15209	111	47277	330	52731	199	55063	103	90442	166
1401	115	15601	107	47278	330	52732	200	55064	103	90452	166
1811	112	15604	107	47279	330	52733	200	55066	103	90462	166
1812	112	19184	169	47322	77	52734	201	55088	103	90482	166
1823	112	19196	169	47325	77	52735	201	55179	83	90502	166
1837	112	40761	250	47326	77	52736	199	64130	71	90512	166
1838	112	40762	250	47329	77	52737	200	64132	71	90522	166
1853	112	40763	250	47378	86	52738	200	64134	71	90542	166
4408	106	40764	250	47390	72	52739	201	64136	71	90552	166
5382	112	40765	251	47391	72	52740	201	64138	71	90562	166
6003	113	40766	251	47392	72	52754	200	86100	319	90622	166
6005	113	40767	251	47393	72	52755	200	86101	319	90642	166
6011	113	40768	251	47395	72	52757	200	86103	319	90662	166
6012	113	40769	251	47396	72	52760	199	86104	319	90682	166
6013	113	40770	251	47397	72	52761	199	86105	319	90922	166
6014	113	40771	251	47398	72	52762	199	86106	319	90942	166
6015	113	40772	251	47400	86	52763	199	86107	319	400780	84
15000	104	40773	251	47703	105	52764	199	86108	319	400880	84
15001	104	40774	251	47704	109	52765	199	86109	319	401080	84
15002	104	40775	251	47713	105	52766	200	86110	319	401280	84
15003	104	40776	251	47714	105	52767	200	86111	319	1512606	103
15005	104	40777	251	47715	105	52768	200	86113	319	1512808	103
15006	104	40778	251	52670	202	52769	200	86114	319	1515106	103
15007	104	40779	251	52671	202	52770	200	86115	319	1515208	103
15008	104	40780	251	52672	202	52771	200	86116	319	1515310	103
15010	104	45682	105	52678	202	52772	200	86117	319	1515512	103
15016	104	47002	86	52680	202	52773	200	86118	319	4075502	250
15017	104	47003	86	52681	202	52774	200	86119	319	4075503	250
15019	104	47004	86	52682	202	52775	200	86120	319	4075602	250
15022	104	47005	86	52683	202	52776	200	86121	319	4075603	250
15024	104	47006	86	52684	200	52777	200	86123	319	4075702	251
15050	104	47042	77	52689	201	52778	201	86124	319	4075703	251
15052	104	47046	77	52691	200	52779	201	86125	319	4075802	251
15053	104	47049	77	52692	200	52780	201	86126	319	4075803	251
15054	104	47139	72	52693	200	52781	201	86127	319	4075902	251
15055	104	47140	72	52694	200	52782	201	86128	319	4075903	251
15058	104	47141	72	52695	202	52783	201	86129	319	4076002	251
15059	104	47142	72	52696	202	52784	201	90002	165	4076003	251
15060	104	47143	72	52699	201	52785	201	90012	165	4656965	85
15061	104	47144	72	52702	200	52786	201	90022	165	4658765	85
15062	104	47145	72	52703	200	52787	201	90042	165	4659065	85
15063	104	47146	72	52704	200	52788	201	90052	165	4659165	85
15064	104	47147	86	52706	200	52789	201	90062	165	4659265	85
15065	104	47150	331	52707	200	52790	201	90082	165	4689760	72
15067	104	47151	331	52708	200	52811	201	90102	165	4689815	72
15068	104	47152	331	52709	200	52812	201	90112	165	4689830	72
15069	104	47153	331	52710	200	52813	201	90122	165	4689840	72
15070	104	47154	331	52711	200	52816	201	90142	165	4689850	72
15072	104	47155	331	52712	200	52817	201	90162	165	4689860	72

REF.	Pag.	REF.	Pag.	REF.	Pag.	REF.	Pag.	REF.	Pag.	REF.	Pag.
4689960	72	4808720	78	6432120	66	484C	106	N-0001G	170	P111.0F1	171
4761965	85	4808780	86	6432220	66	4961-1301	95	N-0002B	170	P111.0F2	171
4763265	85	4808815	78	6432230	66	4961-1308	95	N-0002G	170	P111.0P1	176
4763465	85	4808820	78	6432320	66	4961-13191	95	N-0003B	170	P111.111	163
4763565	85	4808880	86	6432335	66	4961-1332	95	N-0003G	170	P111.501	162
4763765	85	4808915	78	6432420	66	500N	107	N-0006B	170	P111.502	164
4780610	76	4808920	78	6432445	66	501N	107	N-0006G	170	P111.5BF	174
4780620	74	4980120	61	6432480	85	502N	107	P100.002P	169	P111.5C1	172
4780630	74	4980230	61	6432520	66	503N	107	P100.003P	169	P111.5F1	171
4780640	74	4980280	85	6432620	66	5324-13	94	P100.004P	169	P111.5F2	171
4780650	74	4980335	61	6432655	66	6001X	267	P100.005P	169	P111.5P1	176
4780660	74	4980445	61	6432820	66	606N	108	P100.006P	169	P112.001	162
4780670	74	4980480	85	6432865	66	700-1	108	P100.008P	169	P112.002	164
4780680	85	4980655	61	6433120	66	700-4	108	P103.016	37	P112.020	37
4780910	76	4980865	61	6433220	66	808N	108	P103.018	37	P112.025	37
4780911	75	5200080	84	6433230	66	808SG	108	P103.020	37	P112.027	37
4780912	76	5283520	68	6433320	66	ADC-4	223	P103.022	37	P112.030	37
4780920	75	5283620	68	6433335	66	ADP	223	P103.024	37	P112.032	37
4780922	76	5283720	68	6433420	66	BB255E	261	P103.028	37	P112.035	37
4780930	75	5283820	68	6433445	66	BB300E	257	P104.016	37	P112.038	37
4780940	75	5283920	68	6433480	85	BB340E	257	P104.018	37	P112.040	37
4780950	75	5284020	68	6433520	66	BJX240	267	P104.020	37	P112.045	37
4780960	75	5284120	78	6433580	85	CAC132	257	P104.022	37	P112.050	37
4780970	75	5284220	72	6433620	66	CAC93XI	264	P104.024	37	P112.060	37
4780980	85	5284320	72	6433655	66	CAC95I	264	P104.026	37	P112.0C1	172
4781210	76	5292620	68	6433820	66	CB15VE	261	P106.020	37	P112.0P1	176
4781212	76	5292720	68	6433865	66	CTS1000E	272	P106.024	37	P113.030	53
4781220	75	5292820	68	15126060	103	HGB25E	257	P106.028	37	P113.035	53
4781222	76	5292920	68	15128080	103	HR1	192	P106.032	37	P113.040	53
4781230	75	5293320	68	15151060	103	HR1 A	193	P106.040	37	P113.045	53
4781240	75	5293420	68	15152080	103	HR1 AA	193	P107.040	337	P113.050	53
4781250	75	6412120	67	15153100	103	HR1 AAA	193	P107.050	337	P113.055	53
4781260	75	6412220	67	15155120	103	HR1 AAAA	193	P107.060	337	P113.060	53
4781270	75	6412230	67	478091280	85	HR1 B1	193	P109.030	92	P113.065	53
4781280	85	6412320	67	0643N	111	HR1 B1B	193	P109.035	92	P113.070	53
4781610	76	6412335	67	0643SGN	111	HR1 B1BB	193	P109.040	92	P114.040	53
4781612	76	6412420	67	0644N	111	HR1 B1BBB	193	P109.045	92	P114.045	53
4781620	75	6412445	67	0644SGN	111	HR1 C1	193	P109.050	92	P114.050	53
4781622	76	6412520	67	1009-01	182	HR1 C1C	193	P110.000	168	P114.060	53
4781630	75	6412620	67	1009-02	182	HR1 C1CC	193	P110.001	168	P114.070	53
4781640	75	6412655	67	1009-03	182	HR1 C1CCC	193	P110.002	168	P114.540	53
4781650	75	6412820	67	1009-04	182	HR1 D1	193	P110.004	168	P114.545	53
4781660	75	6412865	67	1009-05	182	HR1 D1D	193	P110.005	168	P114.550	53
4781670	75	6414015	71	1009-06	182	HR1 D1DD	193	P110.0BF	175	P115.000	163
4781680	85	6414030	71	1009-08	182	HR1 D1DDD	193	P110.0C1	173	P115.000	217
4790910	76	6414040	71	1009-19	182	HR1 F	193	P110.0C1	177	P115.020	35
4790920	75	6414050	71	1009-32	182	HR1 FF	193	P110.0P1	168	P115.024	35
4790930	75	6414070	71	10815P	84	HR1 FFF	193	P110.0P1	173	P115.028	35
4790940	75	6414080	86	10816P	84	HR2	193	P110.0P1	175	P115.032	35
4790950	75	6414215	71	1500-C80	84	HR2 A	193	P110.0P1	176	P115.040	35
4790960	75	6414230	71	1522-C80	84	HRA	192	P110.201	162	P115.050	35
4790970	75	6414240	71	1527-C80	84	HRB	192	P110.202	164	P115.060	35
4791210	76	6414250	71	2208-1354	94	HRB1	192	P110.401	162	P115.0BF	175
4791220	75	6414270	71	26120-13	95	HRC	192	P110.402	164	P115.0C1	173
4791230	75	6414280	86	26240-13	95	HRC1	192	P110.4F1	171	P115.0P1	177
4791240	75	6422120	67	26320-13	95	HRD	192	P110.551	162	P115.132	36
4791250	75	6422220	67	2800-31	347	HRD1	192	P110.552	164	P115.140	36
4791260	75	6422230	67	2803-18	347	HRF	192	P110.651	162	P115.150	36
4791270	75	6422320	67	2908-13	94	IC70E	268	P110.652	164	P115.160	36
4791610	76	6422335	67	2912-13	94	MX1000XTPEE	263	P110.6BF	174	P116.025	36
4791620	75	6422420	67	3316-13191	94	MX1000XTXEE	263	P110.6C1	172	P116.030	36
4791630	75	6422445	67	400N	106	MX1100XTPSEE	263	P110.6F1	171	P116.035	36
4791640	75	6422520	67	401N	106	MX1100XTXSEE	263	P110.6P1	176	P116.040	36
4791650	75	6422620	67	402NC	106	MX1200XTXEE	264	P111.001	162	P116.045	36
4791660	75	6422655	67	403N	106	MX1500XTPSEE	263	P111.002	164	P116.050	36
4791670	75	6422820	67	403NH	107	MX1500XTXSEE	263	P111.0BF	174	P116.060	36
4808715	78	6422865	67	4400N	106	N-0001B	170	P111.0C1	172	P116.125	35

# ÍNDICE NUMÉRICO / NUMERICAL INDEX / INDEX NUMÉRIQUE / NUMMERISCHER INDEX

REF.	Pag.	REF.	Pag.	REF.	Pag.	REF.	Pag.	REF.	Pag.	REF.	Pag.
P116.130	35	P120.4F1	171	P128.124	44	P135.120	49	P149.330	133	P160.0P1	173
P116.135	35	P120.651	162	P128.128	44	P135.124	49	P15.000	270	P160.0P1	175
P116.140	35	P120.652	164	P128.132	44	P135.128	49	P15.001	270	P160.0P1	176
P116.145	35	P120.6BF	174	P128.220	44	P135.132	49	P15.002	270	P160.651	163
P116.150	35	P120.6C1	172	P128.224	44	P135.136	49	P15.003	270	P160.6BF	175
P116.160	35	P120.6F1	171	P128.228	44	P135.140	49	P15.004	276	P160.6C1	173
P117.025	36	P120.6P1	176	P128.232	44	P135.330	49	P15.005	276	P160.6P1	177
P117.027	36	P120.820	46	P128.320	44	P135.424	49	P15.006	276	P161.001	163
P117.030	36	P120.824	46	P128.324	44	P136.006	355	P15.007	276	P161.0BF	175
P117.032	36	P120.828	46	P128.328	44	P136.007	355	P15.008	276	P161.0C1	173
P117.035	36	P120.832	46	P128.332	44	P136.008	355	P15.009	276	P161.0P1	177
P117.038	36	P120.920	46	P128.420	44	P139.012	46	P15.010	282	P161.501	163
P117.040	36	P120.924	46	P128.424	44	P140.000	168	P15.026	287	P161.5BF	175
P117.045	36	P120.928	46	P128.428	44	P140.001	168	P15.027	287	P161.5C1	173
P117.050	36	P120.932	46	P128.432	44	P140.002	168	P15.028	287	P161.5P1	177
P117.060	36	P121.001	162	P128.920	46	P140.004	168	P15.029	289	P162.001	163
P117.125	35	P121.002	164	P128.924	46	P140.018	45	P15.030	289	P165.024	131
P117.127	35	P121.0BF	174	P128.928	46	P140.020	45	P15.031	288	P165.030	131
P117.130	35	P121.0C1	172	P128.932	46	P140.024	45	P15.032	288	P165.034	131
P117.132	35	P121.0F1	171	P130.000	168	P140.028	45	P15.033	289	P165.0BF	175
P117.135	35	P121.0P1	176	P130.001	168	P140.032	45	P15.034	289	P165.0C1	173
P117.138	35	P121.501	162	P130.002	168	P140.036	45	P15.035	280	P165.0P1	177
P117.140	35	P121.502	164	P130.004	168	P140.040	45	P15.036	278	P166.032	131
P117.145	35	P121.5BF	174	P130.0BF	175	P140.0BF	175	P15.038	273	P166.032V	131
P117.150	35	P121.5C1	172	P130.0C1	173	P140.0C1	173	P15.039	273	P167.026	131
P117.160	35	P121.5F1	171	P130.0C1	177	P140.0C1	177	P15.040	274	P167.028	131
P118.025	36	P121.5P1	176	P130.0P1	168	P140.0P1	168	P15.041	274	P167.030	131
P118.027	36	P122.001	162	P130.0P1	173	P140.0P1	173	P15.042	272	P167.032	131
P118.030	36	P122.002	164	P130.0P1	175	P140.0P1	175	P15.044	278	P168.024	131
P118.032	36	P122.040	53	P130.0P1	176	P140.0P1	176	P15.070	270	P168.028	131
P118.035	36	P122.050	53	P130.201	162	P140.201	163	P15.071	270	P168.030	131
P118.040	36	P122.060	53	P130.202	164	P140.651	163	P15.073	289	P169.020	131
P118.045	36	P122.0C1	172	P130.401	162	P140.6BF	175	P15.074	289	P169.024	131
P118.050	36	P122.0P1	176	P130.402	164	P140.6C1	173	P15.075	282	P169.028	131
P118.060	36	P122.222	163	P130.651	162	P140.6P1	177	P15.080	281	P169.030	131
P118.125	35	P123.040	55	P130.652	164	P141.001	163	P15.084	277	P19.100	324
P118.127	35	P123.060	55	P130.6BF	174	P141.020	134	P15.086	277	P19.101	324
P118.130	35	P123.140	55	P130.6C1	172	P141.024	134	P15.089	248	P19.102	324
P118.132	35	P123.160	55	P130.6P1	177	P141.028	134	P15.090	248	P19.103	325
P118.135	35	P123.240	55	P131.001	162	P141.032	134	P15.091	248	P19.104	325
P118.140	35	P123.260	55	P131.002	164	P141.036	134	P15.095	248	P19.105	325
P118.145	35	P124.020	45	P131.022	45	P141.040	134	P15.096	282	P19.106	325
P118.150	35	P124.024	45	P131.026	45	P141.0BF	175	P15.097	282	P19.107	325
P118.160	35	P124.028	45	P131.0BF	174	P141.0C1	173	P15.028	135	P19.108	325
P120.000	168	P124.032	45	P131.0C1	172	P141.0P1	177	P150.128	133	P19.111	325
P120.001	168	P124.036	45	P131.0P1	177	P141.501	163	P151.016	134	P19.113	324
P120.002	168	P124.040	45	P131.501	162	P141.5BF	175	P151.020	134	P19.114A	324
P120.004	168	P125.000	163	P131.502	164	P141.5C1	173	P151.024	134	P19.114N	324
P120.005	168	P125.038	45	P131.5BF	174	P141.5P1	177	P151.028	134	P19.114R	324
P120.018	44	P125.0BF	175	P131.5C1	172	P1412-6	195	P151.032	134	P19.115A	325
P120.020	44	P125.0C1	173	P131.5P1	177	P1412-6 F1	195	P1510-5	195	P19.115N	325
P120.022	44	P125.0P1	177	P132.001	162	P142.000	135	P1510-5 F1	195	P19.115R	325
P120.024	44	P127.024	45	P132.002	164	P142.001	163	P152.025	135	P19.116	325
P120.026	44	P127.028	45	P132.040	55	P142.100	133	P152.030	135	P190.000	168
P120.028	44	P127.032	45	P132.060	55	P145.000	163	P152.035	135	P190.0BF	175
P120.032	44	P127.036	45	P132.0C1	172	P145.0BF	175	P153.025	135	P190.0C1	173
P120.036	44	P127.040	45	P132.0P1	177	P145.0C1	173	P153.034	135	P190.0C1	177
P120.040	44	P128.018	44	P132.140	56	P145.0P1	177	P153.050	135	P190.0P1	168
P120.0BF	175	P128.020	44	P132.160	56	P148.020	45	P155.032	134	P190.0P1	173
P120.0C1	173	P128.022	44	P132.240	56	P148.024	45	P160.000	168	P190.0P1	175
P120.0C1	177	P128.024	44	P132.260	56	P148.028	45	P160.001	168	P190.0P1	176
P120.0P1	168	P128.026	44	P132.365	54	P148.032	45	P160.002	168	P190.651	163
P120.0P1	173	P128.028	44	P132.560	54	P149.120	133	P160.004	168	P190.6BF	175
P120.0P1	175	P128.032	44	P135.000	163	P149.124	133	P160.0BF	175	P190.6C1	173
P120.0P1	176	P128.036	44	P135.0BF	175	P149.128	133	P160.0C1	173	P190.6P1	177
P120.201	162	P128.040	44	P135.0C1	173	P149.130	133	P160.0C1	177	P191.001	163
P120.401	162	P128.120	44	P135.0P1	177	P149.228	133	P160.0P1	168	P191.0BF	175



REF.	Pag.	REF.	Pag.	REF.	Pag.	REF.	Pag.	REF.	Pag.	REF.	Pag.
P191.0C1	173	P204.035	30	P21.005	326	P216.016	26	P22.030	317	P22.104	314
P191.0P1	177	P204.040	23	P21.006	326	P216.018	26	P22.031	317	P22.105	314
P1912-6	195	P204.040	30	P21.007	326	P216.020	26	P22.033	315	P22.106	314
P1912-6 F1	195	P205.020	26	P21.008	326	P216.024	26	P22.034	315	P22.107	314
P200.012	22	P205.024	26	P21.013	326	P216.028	26	P22.037	307	P22.108	313
P200.012	31	P205.028	26	P21.015	327	P216.030	26	P22.038	307	P22.109	313
P200.014	22	P205.030	26	P21.016	327	P216.032	26	P22.039	300	P22.110	315
P200.014	31	P205.032	26	P21.017	327	P216.035	26	P22.040	299	P22.111	316
P200.016	22	P205.035	26	P21.020	327	P216.040	26	P22.041	300	P22.112	316
P200.016	31	P205.040	26	P21.023	327	P216.045	26	P22.042	299	P22.113	316
P200.018	22	P205.045	26	P21.025	327	P216.050	26	P22.043	300	P22.114	316
P200.018	31	P205.050	26	P21.027	327	P216.060	26	P22.044	299	P22.115	316
P200.020	22	P205.060	26	P21.028	327	P217.016	26	P22.045	300	P22.116	316
P200.020	31	P206.016	27	P21.029	327	P217.018	26	P22.046	299	P22.117	316
P200.022	22	P206.018	27	P210.016	30	P217.020	26	P22.047	300	P22.118	316
P200.022	31	P206.020	27	P210.018	30	P217.024	26	P22.048	299	P22.123	303
P200.024	22	P206.024	27	P210.020	30	P217.028	26	P22.049	300	P22.144	297
P200.024	31	P206.028	27	P210.201	162	P217.030	26	P22.050	299	P22.145	297
P200.028	22	P206.030	27	P210.202	164	P217.032	26	P22.051	300	P22.150	309
P200.028	31	P206.032	27	P210.401	162	P217.035	26	P22.052	299	P22.151	309
P200.116	31	P206.035	27	P210.402	164	P217.040	26	P22.053	300	P22.152	301
P200.120	31	P206.040	27	P210.651	162	P217.045	26	P22.054	299	P22.153	301
P200.320	23	P206.045	27	P210.652	164	P217.050	26	P22.055	301	P22.154	302
P200.320	31	P206.050	27	P211.001	162	P217.060	26	P22.056	301	P22.155	302
P200.324	23	P206.060	27	P211.002	164	P218.016	26	P22.057	301	P22.156	302
P200.324	31	P207.016	27	P211.018	30	P218.018	26	P22.058	301	P22.157	302
P201.016	22	P207.018	27	P211.020	30	P218.020	26	P22.059	301	P22.158	303
P201.016	31	P207.020	27	P211.501	162	P218.024	26	P22.060	301	P22.159	301
P201.018	22	P207.024	27	P211.502	164	P218.028	26	P22.061	301	P22.160	315
P201.018	31	P207.028	27	P2110-5	195	P218.030	26	P22.062	301	P22.161	297
P201.020	22	P207.030	27	P2110-5 F1	195	P218.032	26	P22.063	301	P22.162	297
P201.020	31	P207.032	27	P212.001	162	P218.035	26	P22.064	301	P22.163	310
P201.024	22	P207.035	27	P212.002	164	P218.040	26	P22.065	301	P22.164	307
P201.024	31	P207.040	27	P212.016	30	P218.045	26	P22.066	301	P22.165	307
P201.028	22	P207.045	27	P212.018	30	P218.050	26	P22.067	301	P22.166	307
P201.028	31	P207.050	27	P212.020	30	P218.060	26	P22.068	301	P22.167	312
P201.032	22	P207.060	27	P213.018	48	P219.016	30	P22.069	301	P22.168	312
P201.032	31	P208.016	27	P213.020	48	P219.018	30	P22.070	301	P22.169	313
P2011-5	195	P208.018	27	P213.022	48	P219.020	30	P22.071	301	P22.170	310
P2011-5 F1	195	P208.020	27	P213.024	48	P22.000	307	P22.072	301	P22.171	312
P202.016	22	P208.024	27	P213.026	48	P22.001	307	P22.073	301	P22.172	312
P202.016	31	P208.028	27	P213.028	48	P22.002	309	P22.074	301	P22.173	312
P202.018	22	P208.030	27	P213.032	48	P22.0021	309	P22.075	301	P22.174	313
P202.018	31	P208.032	27	P213.036	48	P22.0023	309	P22.076	301	P22.175	313
P202.020	22	P208.035	27	P213.040	48	P22.003	309	P22.077	301	P22.176	313
P202.020	31	P208.040	27	P214.016	22	P22.0031	309	P22.078	301	P22.177	311
P202.024	22	P208.045	27	P214.016	31	P22.0033	309	P22.079	299	P22.178	315
P202.024	31	P208.050	27	P214.018	22	P22.004	311	P22.080	300	P22.179	315
P202.028	22	P208.060	27	P214.018	31	P22.005	311	P22.081	299	P22.180	315
P202.028	31	P209.014	29	P214.020	22	P22.006	299	P22.082	300	P22.181	315
P202.032	22	P209.016	29	P214.020	31	P22.007	299	P22.083	299	P22.182	316
P202.032	31	P209.018	29	P214.022	22	P22.008	299	P22.084	300	P22.183	316
P203.016	30	P209.020	29	P214.022	31	P22.009	300	P22.085	309	P22.184	316
P203.018	30	P209.022	29	P214.024	22	P22.010	300	P22.086	309	P22.185	317
P203.020	30	P209.024	29	P214.024	31	P22.011	300	P22.087	299	P22.200	312
P203.024	30	P209.028	29	P215.000	163	P22.012	307	P22.088	314	P22.200A	312
P204.020	23	P209.030	29	P215.000	217	P22.013	307	P22.089	299	P22.200AM	312
P204.020	30	P209.032	29	P215.020	27	P22.014	307	P22.090	309	P22.200N	312
P204.024	23	P209.035	29	P215.024	27	P22.015	307	P22.091	307	P22.200R	312
P204.024	30	P209.040	29	P215.028	27	P22.016	307	P22.092	307	P22.200V	312
P204.028	23	P209.045	29	P215.030	27	P22.017	297	P22.097	315	P22.201	312
P204.028	30	P209.050	29	P215.032	27	P22.018	297	P22.098	315	P22.202	312
P204.030	23	P209.060	29	P215.035	27	P22.019	311	P22.099	313	P22.202A	312
P204.030	30	P21.000	326	P215.040	27	P22.020	311	P22.100	311	P22.202AM	312
P204.032	23	P21.001	326	P215.045	27	P22.021	311	P22.101	311	P22.202N	312
P204.032	30	P21.003	326	P215.050	27	P22.022	311	P22.102	311	P22.202R	312
P204.035	23	P21.004	326	P215.060	27	P22.023	311	P22.103	310	P22.202V	312

REF.	Pag.	REF.	Pag.	REF.	Pag.	REF.	Pag.	REF.	Pag.	REF.	Pag.
P22.203	312	P22.960	304	P241.050	28	P290.140	20	P301.108	60	P313.030	93
P22.203A	312	P22.971	304	P241.060	28	P290.145	20	P301.109	60	P313.126	93
P22.203AM	312	P22.972	304	P241.070	28	P290.150	20	P301.110	60	P313.132	93
P22.203N	312	P220.018	47	P241.501	162	P291.020	21	P301.112	60	P313.200	93
P22.203R	312	P220.020	47	P242.020	28	P291.024	21	P301.114	60	P313.500	93
P22.203V	312	P220.022	47	P242.024	28	P291.028	21	P301.116	60	P314.110	62
P22.204	312	P220.024	47	P242.028	28	P291.030	21	P301.118	60	P314.112	62
P22.211	312	P220.026	47	P242.032	28	P291.032	21	P301.165	60	P314.210	62
P22.220	303	P220.028	47	P242.035	28	P291.035	21	P301.206	60	P314.212	62
P22.221	303	P220.032	47	P243.020	28	P291.040	21	P301.208	60	P314.300	62
P22.222	303	P220.036	47	P243.024	28	P291.045	21	P301.210	60	P315.010	70
P22.250	314	P220.040	47	P243.028	28	P291.050	21	P301.212	60	P315.012	70
P22.251	314	P220.820	48	P243.032	28	P291.060	21	P301.214	60	P315.015	70
P22.270	306	P220.824	48	P243.035	28	P291.120	20	P301.216	60	P315.017	70
P22.271	306	P220.828	48	P244.020	28	P291.124	20	P302.108	62	P315.020	70
P22.272	306	P220.832	48	P244.024	28	P291.128	20	P302.110	62	P316.025	338
P22.273	306	P220.836	48	P244.028	28	P291.130	20	P302.112	62	P316.030	338
P22.274	306	P220.840	48	P244.032	28	P291.132	20	P302.114	62	P316.035	338
P22.275	306	P223.035	29	P244.035	28	P291.135	20	P302.116	62	P316.040	338
P22.500	310	P223.040	29	P248.028	29	P291.140	20	P302.118	62	P316.045	338
P22.501	310	P224.023	29	P248.032	29	P291.145	20	P302.120	62	P316.050	338
P22.502	310	P224.026	29	P248.035	29	P291.150	20	P302.210	62	P316.125	338
P22.600	295	P23.550	151	P248.040	29	P291.160	20	P302.212	62	P316.130	338
P22.601	295	P23.551	151	P248.045	29	P292.016	21	P302.214	62	P316.135	338
P22.602	295	P23.552	151	P249.028	29	P292.020	21	P302.216	62	P316.140	338
P22.603	295	P230.000	168	P249.032	29	P292.024	21	P303.016	91	P316.145	338
P22.604	295	P230.001	168	P249.035	29	P292.028	21	P303.018	91	P316.150	338
P22.605	295	P230.201	162	P249.040	29	P292.030	21	P303.020	91	P316.530	338
P22.606	295	P230.202	164	P249.045	29	P292.032	21	P303.022	91	P316.630	338
P22.610B	296	P230.401	162	P251.020	137	P292.035	21	P303.024	91	P316.635	338
P22.610N	296	P230.402	164	P251.024	137	P292.040	21	P303.026	91	P316.640	338
P22.611B	296	P230.651	162	P251.028	137	P292.045	21	P303.200	91	P318.005	54
P22.611N	296	P230.652	164	P251.032	137	P292.050	21	P303.265	60	P318.040	54
P22.612B	296	P231.001	162	P26.000	323	P292.060	21	P304.016	336	P318.060	54
P22.612N	296	P231.002	164	P26.001	323	P292.120	20	P304.018	336	P318.211	54
P22.613B	296	P231.501	162	P26.002	323	P292.124	20	P304.020	336	P32.902	150
P22.613N	296	P231.502	164	P26.003	323	P292.128	20	P304.022	336	P32.905	150
P22.614B	296	P232.001	162	P269.035	53	P292.130	20	P304.024	336	P32.906	150
P22.614N	296	P232.002	164	P270.016	146	P292.132	20	P305.020	145	P32.908	150
P22.615B	296	P233.024	137	P270.020	146	P292.135	20	P305.022	145	P32.909	150
P22.615N	296	P233.028	137	P270.024	146	P292.140	20	P306.035	336	P32.911	150
P22.616B	296	P233.032	137	P270.028	146	P292.145	20	P307.020	336	P32.912	150
P22.616N	296	P233.124	137	P271.016	146	P292.150	20	P307.025	336	P3208-3	196
P22.620	296	P233.128	137	P271.020	146	P292.160	20	P307.030	336	P3208-3 F1	196
P22.621	296	P233.132	137	P271.024	146	P293.028	21	P307.035	336	P321.020	92
P22.622	296	P234.016	137	P271.028	146	P293.032	21	P307.040	336	P321.022	92
P22.640B	296	P234.018	137	P272.014	146	P293.035	21	P307.045	336	P321.024	92
P22.640N	296	P234.020	137	P272.016	146	P293.040	21	P307.050	336	P321.026	92
P22.641B	296	P234.024	137	P272.018	146	P293.128	20	P307.060	336	P322.101	89
P22.641N	296	P234.028	137	P272.020	146	P293.132	20	P307.070	336	P322.102	89
P22.642B	296	P235.000	163	P273.024	146	P293.135	20	P307.125	336	P322.103	89
P22.642N	296	P237.120	139	P273.028	146	P293.140	20	P307.130	336	P322.104	89
P22.650	295	P237.124	139	P290.020	21	P299.016	23	P307.140	336	P322.201	89
P22.651	295	P238.120	137	P290.024	21	P299.020	23	P307.150	336	P322.202	89
P22.652	295	P239.036	137	P290.028	21	P299.024	23	P307.230	336	P322.203	89
P22.670	297	P239.136	137	P290.030	21	P299.028	23	P307.240	336	P322.204	89
P22.671	297	P239.236	48	P290.032	21	P299.030	23	P308.030	92	P323.050	97
P22.672	297	P239.336	48	P290.035	21	P299.032	23	P308.035	92	P324.013	90
P22.890	314	P239.436	137	P290.040	21	P299.035	23	P308.040	92	P324.016	90
P22.901	304	P239.536	137	P290.045	21	P299.040	23	P308.045	92	P324.019	90
P22.902	304	P240.040	28	P290.050	21	P299.045	23	P308.050	92	P324.022	90
P22.911	304	P240.050	28	P290.120	20	P299.050	23	P309.035	53	P324.025	90
P22.912	304	P240.070	28	P290.124	20	P299.060	23	P309.040	53	P325.008	90
P22.920	305	P240.401	162	P290.128	20	P300.024	92	P309.050	53	P325.010	90
P22.930	305	P240.651	162	P290.130	20	P300.030	92	P309.060	53	P325.012	90
P22.940	305	P241.001	162	P290.132	20	P3008-4	195	P309.070	53	P325.015	90
P22.950	305	P241.040	28	P290.135	20	P3008-4 F1	195	P313.025	93	P325.018	90

REF.	Pag.	REF.	Pag.	REF.	Pag.	REF.	Pag.	REF.	Pag.	REF.	Pag.
P325.020	90	P350.730	345	P376.037	69	P400.928	33	P490.624	139	P5160 E4F1	189
P328.020	88	P350.735	345	P376.137	69	P400.932	33	P490.624A	140	P5160 E5	186
P328.023	88	P350.740	345	P377.037	69	P400.935	33	P490.624G	140	P5160 E5F1	189
P328.600	88	P354.025	338	P377.137	69	P400.940	33	P490.624N	140	P5160 F1	188
P33.601	148	P354.030	338	P38.240.250	245	P404.512	145	P490.624R	140	P5161	184
P33.602	148	P354.035	338	P38.250.250	244	P404.514	145	P490.628	139	P5161 F1	188
P33.603	148	P354.040	338	P38.550.250	245	P404.516	145	P490.628A	140	P5250	184
P33.604	148	P354.045	338	P380.000	79	P404.518	145	P490.628G	140	P5250 E1	186
P33.605	148	P354.050	338	P381.008	79	P404.520	145	P490.628N	140	P5250 E1F1	189
P33.607	148	P355.007	355	P381.010	79	P406.524	144	P490.628R	140	P5250 E2	186
P33.608	149	P355.008	355	P382.000	79	P406.528	144	P490.632	139	P5250 E2F1	189
P33.610	149	P355.107	355	P383.000	79	P407.516	144	P490.632A	140	P5250 E3	186
P33.612	149	P355.108	355	P384.000	79	P407.520	144	P490.632G	140	P5250 E3F1	189
P33.614	149	P356.016	337	P385.020	79	P407.524	144	P490.632N	140	P5250 E4	186
P33.620	149	P356.020	337	P385.026	79	P407.528	144	P490.632R	140	P5250 E4F1	189
P331.039	331	P356.024	337	P385.030	79	P407.532	144	P490.716	139	P5250 E5	186
P331.044	331	P356.028	337	P385.500	79	P408.516	144	P490.720	139	P5250 E5F1	189
P331.050	331	P356.032	337	P386.000	79	P408.520	144	P490.724	139	P5250 F1	188
P331.056	331	P358.024	74	P390.000	114	P408.524	144	P490.728	139	P5251	184
P331.059	331	P358.029	74	P390.100	114	P408.528	144	P490.732	139	P5251 F1	188
P331.066	331	P358.040	74	P391.000	88	P408.532	144	P490.732A	140	P5360	185
P331.070	331	P358.241	74	P392.065	60	P410.524	145	P490.732G	140	P5360 E1	187
P332.010	332	P358.242	74	P393.080	338	P411.524	144	P490.732N	140	P5360 E1F1	189
P332.095	332	P358.243	74	P393.100	338	P411.528	144	P490.732R	140	P5360 E2	187
P334.025	96	P358.244	74	P393.125	338	P412.020	145	P490.824	138	P5360 E2F1	189
P334.050	96	P358.245	74	P394.008	70	P412.024	145	P490.828	138	P5360 E3	187
P334.100	96	P358.246	74	P394.012	70	P4407-3	196	P5000	191	P5360 E3F1	189
P334.200	96	P358.247	74	P395.038	69	P4407-3 F1	196	P5001	191	P5360 E4	187
P340.000	320	P358.301	74	P396.009	60	P454.012	143	P5002	191	P5360 E4F1	189
P340.010	147	P358.302	74	P396.010	60	P454.014	143	P5003	191	P5360 E5	187
P340.020	147	P358.303	74	P396.012	60	P454.016	143	P5004	191	P5360 E5F1	189
P340.030	147	P358.304	74	P397.247	69	P454.018	143	P501 F1	181	P5360 F1	188
P340.040	147	P358.305	74	P397.347	70	P454.020	143	P501 F2	181	P5361	185
P340.050	147	P358.306	74	P398.024	339	P456.016	143	P501 F3	181	P5361 F1	188
P340.060	147	P358.307	74	P398.035	339	P456.020	143	P501 F4	181	P5490	185
P340.070	147	P358.401	74	P398.042	339	P456.024	143	P501 F5	181	P5490 E1	187
P340.080	147	P358.402	74	P398.125	339	P456.028	143	P501 F6	181	P5490 E1F1	189
P340.090	147	P358.403	74	P398.135	339	P456.032	143	P5015	222	P5490 E2	187
P343.400	73	P358.404	74	P398.140	339	P457.016	143	P5017	222	P5490 E2F1	189
P343.500	73	P358.405	74	P398.225	339	P457.020	143	P5018	191	P5490 E3	187
P343.600	73	P358.406	74	P398.235	339	P457.024	143	P5019	191	P5490 E3F1	189
P343.700	73	P358.407	74	P398.240	339	P457.028	143	P5060	191	P5490 E4	187
P343.800	73	P36.790.250	246	P398.290	339	P457.032	143	P5061	191	P5490 E4F1	189
P347.020	91	P37.318	151	P400.016	33	P458.024	143	P5062	191	P5490 E5	187
P347.024	91	P373.020	91	P400.018	33	P458.028	143	P508.015	288	P5490 E5F1	189
P348.008	90	P373.024	91	P400.020	33	P459.018	143	P5090	184	P5490 F1	188
P348.010	90	P373.028	91	P400.024	33	P459.020	143	P5090 E1	186	P5491	185
P348.012	90	P374.013	90	P400.320	33	P459.024	143	P5090 E1F1	189	P5491 F1	188
P348.015	90	P374.015	90	P400.324	33	P459.028	143	P5090 E2	186	P600.005	120
P348.018	90	P374.018	90	P400.424	33	P460.018	146	P5090 E2F1	189	P601.010	120
P350.230	345	P374.020	90	P400.624	33	P460.020	146	P5090 E3	186	P602.015	120
P350.235	345	P374.026	90	P400.628	33	P460.022	146	P5090 E3F1	189	P603.012	123
P350.330	345	P375.010	80	P400.632	33	P460.024	146	P5090 E4	186	P603.015	123
P350.335	345	P375.020	80	P400.635	33	P460.026	146	P5090 E4F1	189	P604.001	123
P350.426	345	P375.030	90	P400.640	33	P460.028	146	P5090 E5	186	P604.002	123
P350.430	345	P375.035	90	P400.724	32	P460.030	146	P5090 E5F1	189	P604.500	123
P350.435	345	P375.041	80	P400.728	32	P460.032	146	P5090 F1	188	P607.000	58
P350.440	345	P375.042	80	P400.732	32	P470.005	145	P5091	184	P609.010	120
P350.526	345	P375.050	80	P400.735	32	P490.012	139	P5091 F1	188	P609.200	121
P350.530	345	P375.061	80	P400.824	32	P490.014	139	P5160	184	P609.705	121
P350.535	345	P375.062	80	P400.828	32	P490.016	139	P5160 E1	186	P610.000	114
P350.540	345	P375.063	80	P400.832	32	P490.018	139	P5160 E1F1	189	P611.000	121
P350.626	345	P375.070	81	P400.835	32	P490.020	139	P5160 E2	186	P611.001	77
P350.630	345	P375.080	81	P400.916	33	P490.220	139	P5160 E2F1	189	P620.001	77
P350.635	345	P375.090	81	P400.918	33	P490.224	139	P5160 E3	186	P621.000	77
P350.640	345	P375.100	81	P400.920	33	P490.616	139	P5160 E3F1	189	P621.001	77
P350.726	345	P375.110	81	P400.924	33	P490.620	139	P5160 E4	186	P6305-2	196

REF.	Pag.	REF.	Pag.	REF.	Pag.	REF.	Pag.	REF.	Pag.	REF.	Pag.
P6305-2 F1	196	P7040	232	P7098	236	P7148	232	P720.012	351	P7258	236
P640.000	208	P7041	232	P7099	236	P7149	232	P7200	234	P7259	236
P641.100	208	P7042	232	P710.020	349	P715.006	350	P7201	234	P7260	236
P642.000	208	P7043	232	P710.024	349	P7150	232	P7202	234	P7261	236
P643.000	208	P7044	232	P710.028	349	P7151	232	P7203	234	P7262	236
P688.010	281	P7045	232	P710.032	349	P7152	232	P7204	234	P7263	236
P688.045	288	P7046	232	P710.205	289	P7153	232	P7205	234	P7264	236
P688.085	278	P7047	234	P710.206	289	P7154	232	P7206	234	P7265	236
P688.087	278	P7048	234	P7100	236	P7155	232	P7207	234	P7266	236
P688.150	280	P7049	234	P7101	236	P7156	232	P7208	234	P7267	236
P7000	232	P705.024	57	P7102	236	P7157	232	P7209	234	P7268	236
P7001	232	P705.028	57	P7103	236	P7158	232	P721.005	351	P7269	236
P7002	232	P705.032	57	P7104	236	P7159	232	P721.006	351	P7270	236
P7003	232	P7050	234	P7105	236	P716.008	351	P721.007	351	P7271	236
P7004	232	P7051	234	P7106	236	P716.010	351	P721.008	351	P7272	236
P7004R	231	P7052	234	P7107	236	P716.012	351	P721.010	351	P7273	236
P7005	232	P7053	234	P7108	236	P7160	232	P7210	234	P7274	236
P7005R	231	P7054	234	P7109	236	P7161	232	P7211	234	P7275	236
P7006	232	P7055	234	P711.010	349	P7162	232	P7212	234	P7276	236
P7006R	231	P7056	234	P711.012	349	P7163	232	P7213	234	P7277	236
P7007	232	P7057	234	P711.020	349	P7164	232	P7214	234	P7278	236
P7008	232	P7058	234	P711.024	349	P7165	232	P7215	234	P7279	236
P7009	232	P7059	234	P711.028	349	P7166	232	P7216	234	P7280	236
P701.014	350	P706.039	348	P711.032	349	P7167	232	P7217	234	P7281	236
P701.016	350	P7060	234	P7110	236	P7168	232	P7218	234	P7282	233
P701.018	350	P7061	234	P7111	236	P7169	232	P7219	234	P7283	233
P701.020	350	P7062	234	P7112	236	P717.008	351	P722.000	351	P7284	233
P701.022	350	P7063	234	P7113	236	P717.010	351	P7220	234	P7285	233
P7010	232	P7064	234	P7114	236	P7170	232	P7221	234	P7286	233
P7011	232	P7065	234	P7115	236	P7171	232	P7222	234	P7287	233
P7012	232	P7066	234	P7116	236	P7172	232	P7223	234	P7288	233
P7013	232	P7067	234	P7117	236	P7173	232	P7224	234	P7289	233
P7014	232	P7068	234	P7118	236	P7174	232	P7225	234	P7290	233
P7015	232	P7069	234	P7119	236	P7175	232	P7226	234	P7291	233
P7016	232	P707.039	348	P712.022	350	P7176	232	P7227	234	P7292	233
P7017	232	P7070	234	P7120	236	P7177	232	P7228	234	P7293	233
P7018	232	P7071	234	P7121	236	P7178	232	P7229	234	P7294	233
P7019	232	P7072	234	P7122	236	P7179	232	P723.024	349	P7295	233
P702.026	348	P7073	234	P7123	236	P718.006	351	P723.028	349	P7296	233
P702.028	348	P7074	234	P7124	236	P718.008	351	P7230	234	P7297	233
P702.230	348	P7075	234	P7125	236	P718.010	351	P7231	234	P7298	233
P7020	232	P7076	234	P7126	236	P718.011	351	P7232	234	P7299	233
P7021	232	P7077	234	P7127	236	P7180	232	P7233	234	P7300	233
P7022	232	P7078	234	P7128	236	P7181	232	P7234	234	P7301	233
P7023	232	P7079	234	P7129	236	P7182	232	P7235	236	P7302	233
P7024	232	P708.008	350	P713.075	350	P7183	232	P7236	236	P7303	233
P7025	232	P708.022	350	P7130	236	P7184	232	P7237	236	P7304	233
P7026	232	P708.024	350	P7131	236	P7185	232	P7238	236	P7305	233
P7027	232	P7080	234	P7132	236	P7186	232	P7239	236	P7306	233
P7028	232	P7081	234	P7133	236	P7187	232	P7240	236	P7307	233
P7029	232	P7082	234	P7134	236	P7188	234	P7241	236	P7308	233
P703.020	349	P7083	234	P7135	236	P7189	234	P7242	236	P7309	233
P703.024	349	P7084	234	P7136	236	P7190	234	P7243	236	P7310	233
P703.028	349	P7085	234	P7137	236	P7191	234	P7244	236	P7311	233
P703.032	349	P7086	234	P7138	236	P7192	234	P7245	236	P7312	233
P7030	232	P7087	234	P7139	236	P7193	234	P7246	236	P7313	233
P7031	232	P7088	234	P7140	236	P7194	234	P7247	236	P7314	233
P7032	232	P7089	234	P7141	232	P7195	234	P7248	236	P7315	233
P7033	232	P709.035	348	P7142	232	P7196	234	P7249	236	P7316	233
P7034	232	P7090	234	P7143	232	P7197	234	P7250	236	P7317	233
P7035	232	P7091	234	P7144	232	P7198	234	P7251	236	P7318	233
P7036	232	P7092	234	P7145	232	P7199	234	P7252	236	P7319	233
P7037	232	P7093	234	P7145R	231	P720.005	351	P7253	236	P732.000	352
P7038	232	P7094	236	P7146	232	P720.006	351	P7254	236	P7320	233
P7039	232	P7095	236	P7146R	231	P720.007	351	P7255	236	P7321	233
P704.024	348	P7096	236	P7147	232	P720.008	351	P7256	236	P7322	233
P704.030	348	P7097	236	P7147R	231	P720.010	351	P7257	236	P7323	233



REF.	Pag.	REF.	Pag.	REF.	Pag.	REF.	Pag.	REF.	Pag.	REF.	Pag.
P7324	233	P7388	237	P7455	233	P7522	237	P7590	229	P778.048	55
P7325	233	P7389	237	P7456	233	P7523	237	P7591	229	P778.060	55
P7326	233	P7390	237	P7457	233	P7524	237	P7592	229	P779.017	54
P7327	233	P7391	237	P7458	233	P7525	237	P7593	229	P779.021	54
P7328	233	P7392	237	P7459	233	P7526	237	P7594	229	P779.026	54
P7329	235	P7393	237	P7460	233	P7527	237	P7595	229	P779.060	54
P733.000	352	P7394	237	P7461	233	P7528	237	P7596	229	P780.006	353
P7330	235	P7395	237	P7462	233	P7529	237	P7597	229	P780.008	353
P7331	235	P7396	237	P7463	233	P7530	237	P7598	229	P780.010	353
P7332	235	P7397	237	P7464	233	P7531	237	P7599	229	P780.020	353
P7333	235	P7398	237	P7465	233	P7532	237	P7603	231	P780.024	353
P7334	235	P7399	237	P7466	233	P7533	237	P7604	231	P780.028	353
P7335	235	P7400	237	P7467	233	P7534	237	P7605	231	P781.006	353
P7336	235	P7401	237	P7468	233	P7535	237	P7606	231	P781.008	353
P7337	235	P7402	237	P7469	233	P7536	237	P7607	231	P781.010	353
P7338	235	P7403	237	P7470	235	P7537	237	P7608	231	P781.018	353
P7339	235	P7404	237	P7471	235	P7538	237	P7609	231	P781.020	353
P7340	235	P7405	237	P7472	235	P7539	237	P7610	231	P782.008	353
P7341	235	P7406	237	P7473	235	P7540	237	P7611	231	P782.010	353
P7342	235	P7407	237	P7474	235	P7541	237	P7612	231	P782.012	353
P7343	235	P7408	237	P7475	235	P7542	237	P7613	231	P782.014	353
P7344	235	P7409	237	P7476	235	P7543	237	P7614	231	P782.016	353
P7345	235	P7410	237	P7477	235	P7544	237	P7615	231	P782.018	353
P7346	235	P7411	237	P7478	235	P7545	237	P7616	231	P782.020	353
P7347	235	P7412	237	P7479	235	P7546	237	P7617	231	P782.022	353
P7348	235	P7413	237	P7480	235	P7547	237	P7618	231	P782.024	353
P7349	235	P7414	237	P7481	235	P7548	237	P7628	230	P782.026	353
P7350	235	P7415	237	P7482	235	P7549	237	P7629	230	P782.028	353
P7351	235	P7416	237	P7483	235	P7550	237	P7630	230	P782.075	353
P7352	235	P7417	237	P7484	235	P7551	237	P7631	230	P783.006	353
P7353	235	P7418	237	P7485	235	P7552	237	P7632	230	P783.008	353
P7354	235	P7419	237	P7486	235	P7553	237	P7633	230	P783.010	353
P7355	235	P7420	237	P7487	235	P7554	237	P7634	230	P783.012	353
P7356	235	P7421	237	P7488	235	P7555	237	P7635	230	P783.014	353
P7357	235	P7422	237	P7489	235	P7556	237	P7636	230	P783.016	353
P7358	235	P7423	233	P7490	235	P7557	237	P7637	230	P783.018	353
P7359	235	P7424	233	P7491	235	P7558	237	P7638	230	P783.020	353
P736.030	57	P7425	233	P7492	235	P7559	237	P7639	230	P783.022	353
P736.034	57	P7426	233	P7493	235	P7560	237	P764.004	355	P783.024	353
P7360	235	P7427	233	P7494	235	P7561	237	P764.006	355	P783.026	353
P7361	235	P7428	233	P7495	235	P7562	237	P764.008	355	P783.028	353
P7362	235	P7429	233	P7496	235	P7563	237	P764.010	355	P783.030	353
P7363	235	P7430	233	P7497	235	P7565	228	P764.012	355	P784.020	355
P7364	235	P7431	233	P7498	235	P7566	228	P764.014	355	P784.025	355
P7365	235	P7432	233	P7499	235	P7567	228	P7640	230	P784.030	355
P7366	235	P7433	233	P7500	235	P7568	228	P7641	230	P784.035	355
P7367	235	P7434	233	P7501	235	P7569	228	P7642	230	P784.040	355
P7368	235	P7435	233	P7502	235	P7570	228	P7643	230	P785.006	353
P7369	235	P7436	233	P7503	235	P7571	228	P7646	229	P785.008	353
P7370	235	P7437	233	P7504	235	P7572	228	P7647	229	P785.010	353
P7371	235	P7438	233	P7505	235	P7573	228	P765.020	354	P785.012	353
P7372	235	P7439	233	P7506	235	P7574	228	P765.022	354	P785.016	353
P7373	235	P7440	233	P7507	235	P7575	228	P765.024	354	P785.020	353
P7374	235	P7441	233	P7508	235	P7576	228	P768.006	354	P788.025	355
P7375	235	P7442	233	P7509	235	P7577	228	P768.008	354	P788.050	355
P7376	237	P7443	233	P7510	235	P7578	228	P768.016	354	P789.025	355
P7377	237	P7444	233	P7511	235	P7579	228	P769.008	354	P789.050	355
P7378	237	P7445	233	P7512	235	P7580	228	P769.010	354	P796.000	352
P7379	237	P7446	233	P7513	235	P7581	228	P769.018	354	P796.100	352
P7380	237	P7447	233	P7514	235	P7582	228	P769.020	354	P798.040	357
P7381	237	P7448	233	P7515	235	P7583	228	P769.022	354	P798.055	357
P7382	237	P7449	233	P7516	235	P7584	228	P770.014	354	P798.065	357
P7383	237	P7450	233	P7517	237	P7585	229	P771.025	354	P80.210	206
P7384	237	P7451	233	P7518	237	P7586	229	P777.540	55	P80.216	207
P7385	237	P7452	233	P7519	237	P7587	229	P777.548	55	P80.219	206
P7386	237	P7453	233	P7520	237	P7588	229	P777.560	55	P80.220	206
P7387	237	P7454	233	P7521	237	P7589	229	P778.040	55	P80.240	209

REF.	Pag.	REF.	Pag.	REF.	Pag.	REF.	Pag.	REF.	Pag.	REF.	Pag.
P80.250	209	P800.035	357	P830.005	346	P851.050	357	P859.179	375	P90.813	207
P80.260	209	P800.040	357	P833.001	58	P851.060	357	P859.183	372	P90.814	207
P80.270	209	P800.045	357	P833.002	58	P853.004	361	P859.184	372	P900.000	320
P80.280	209	P800.050	357	P833.003	58	P853.006	361	P859.185	372	P901.014	118
P80.290	209	P800.055	357	P834.000	344	P853.008	361	P859.186	372	P901.018	118
P80.300	209	P800.060	357	P835.000	344	P853.010	361	P859.189	372	P905.015	96
P80.310	209	P800.065	357	P836.110	342	P853.012	361	P859.190	372	P908.000	332
P80.320	209	P800.070	357	P836.120	342	P853.014	361	P859.191	372	P908.001	332
P80.330	210	P801.040	341	P836.147	342	P853.016	361	P859.192	373	P908.002	332
P80.340	210	P801.048	341	P836.200	342	P854.006	361	P859.195	373	P908.003	332
P80.350	210	P802.000	341	P836.215	342	P854.008	361	P859.196	373	P908.004	332
P80.360	210	P803.000	341	P837.003	345	P854.010	361	P859.197	373	P909.111	56
P80.374	211	P804.000	341	P837.005	345	P854.012	361	P859.198	373	P909.121	56
P80.380	220	P805.000	340	P837.007	345	P854.014	361	P859.200	374	P909.211	56
P80.390	220	P807.000	340	P837.300	345	P854.016	361	P859.201	374	P909.221	56
P80.430	213	P808.000	342	P839.000	340	P855.000	361	P859.202	374	P909.340	56
P80.440	215	P81.000	286	P840.000	340	P856.000	361	P859.203	375	P909.360	56
P80.460	216	P81.010	286	P842.000	340	P857.000	361	P859.204	375	P909.460	56
P80.470	214	P81.020	286	P845.040	341	P859.101	370	P859.205	375	P909.559	347
P80.480	215	P810.002	358	P845.050	341	P859.102	370	P859.206	373	P911.201	117
P80.500	216	P810.004	358	P845.060	341	P859.103	370	P859.207	373	P911.202	117
P80.510	215	P810.006	358	P845.075	341	P859.104	370	P859.210	374	P911.301	117
P80.520	214	P810.008	358	P845.110	341	P859.105	370	P859.211	374	P911.302	117
P80.530	216	P810.010	358	P845.138	341	P859.106	373	P859.212	374	P911.303	117
P80.540	221	P810.012	358	P845.155	341	P859.107	373	P859.219	371	P911.304	117
P80.550	221	P810.014	358	P845.275	341	P859.109	370	P859.900	366	P911.305	117
P80.560	221	P810.016	358	P846.025	123	P859.110	370	P859.901	366	P911.306	117
P80.570	221	P811.002	358	P846.050	123	P859.111	370	P859.902	366	P911.401	117
P80.580	222	P811.004	358	P846.100	123	P859.112	375	P859.903	366	P911.402	117
P80.590	222	P811.006	358	P846.200	123	P859.113	369	P859.904	366	P911.403	117
P80.610	221	P811.008	358	P846.300	123	P859.114	372	P859.905	366	P911.404	117
P80.620	221	P811.010	358	P848.008	342	P859.115	369	P859.906	367	P911.405	117
P80.630	221	P811.012	358	P848.014	342	P859.116	374	P859.907	367	P911.406	117
P80.640	221	P811.014	358	P849.000	357	P859.117	373	P859.908	367	P911.501	118
P80.670	213	P811.016	358	P850.001	363	P859.119	375	P859.909	367	P911.502	118
P80.680	211	P811.018	358	P850.002	363	P859.120	375	P859.910	367	P911.503	118
P80.700	320	P812.003	358	P850.003	363	P859.121	375	P859.911	367	P911.504	118
P80.710	320	P812.005	358	P850.004	363	P859.122	371	P861.045	319	P911.505	118
P80.720	320	P812.007	358	P850.005	363	P859.123	371	P861.053	319	P911.506	118
P80.730	320	P812.009	358	P850.006	363	P859.124	371	P867.030	314	P911.601	118
P80.740	220	P812.011	358	P850.007	363	P859.125	372	P867.060	314	P911.602	118
P80.740	318	P813.016	358	P850.010	363	P859.126	372	P867.090	314	P911.603	118
P80.750	222	P813.020	358	P850.012	363	P859.129	373	P867.120	314	P911.604	118
P80.760	222	P813.028	358	P850.017	363	P859.130	371	P868.001	94	P911.605	118
P80.770	222	P814.000	359	P850.018	363	P859.132	369	P868.002	94	P911.606	118
P80.780	221	P815.004	359	P850.022	363	P859.134	369	P868.003	94	P911.701	117
P80.800	213	P815.006	359	P850.023	363	P859.135	369	P868.004	94	P911.801	117
P80.810	217	P815.009	359	P850.024	363	P859.139	369	P868.005	94	P911.802	117
P80.811	217	P815.012	359	P850.025	363	P859.141	369	P868.006	94	P911.803	117
P80.813	217	P815.015	359	P850.026	363	P859.142	369	P868.007	94	P911.804	117
P80.814	217	P815.018	359	P850.027	363	P859.143	370	P868.008	94	P911.805	117
P80.840	216	P816.011	358	P850.028	363	P859.144	370	P868.009	94	P911.806	117
P80.850	216	P816.013	358	P850.030	363	P859.150	370	P870.000	96	P911.901	118
P80.870	216	P816.015	358	P850.031	363	P859.151	370	P871.000	96	P911.902	118
P80.880	216	P817.005	358	P850.032	364	P859.152	370	P872.000	79	P911.903	118
P80.890	218	P817.006	358	P850.033	364	P859.153	370	P872.500	342	P911.904	118
P80.891	218	P817.008	358	P850.034	364	P859.154	371	P873.045	96	P911.905	118
P80.900	208	P820.000	359	P850.037	364	P859.155	371	P873.060	96	P911.906	118
P80.910	219	P821.000	359	P850.124	365	P859.156	371	P873.090	96	P912.001	117
P80.940	211	P822.000	360	P850.128	365	P859.157	371	P875.003	332	P913.000	118
P80.941	211	P823.000	360	P850.222	365	P859.158	371	P875.004	332	P913.501	118
P80.950	219	P824.000	360	P850.424	365	P859.159	371	P90.490	204	P913.601	118
P80.951	219	P826.000	357	P850.426	365	P859.167	371	P90.492	204	P913.701	118
P80.960	210	P830.001	346	P850.528	365	P859.169	371	P90.492	205	P913.901	118
P80.961	210	P830.002	346	P850.614	365	P859.171	372	P90.493	204	P914.080	333
P80.970	214	P830.003	346	P851.040	357	P859.172	372	P90.493	205	P914.120	333
P800.030	357	P830.004	346	P851.046	357	P859.174	374	P90.495	205	P914.150	333

REF.	Pag.	REF.	Pag.	REF.	Pag.	REF.	Pag.	REF.	Pag.
P915.080	333	P948.090	58	P981.600	122	RE15.095-6	248	TRJ	184
P915.150	333	P948.132	58	P981.650	122	RE15.095-7	248	TRM	185
P916.000	333	P948.163	58	P99.00.000	247	RE15.095-8	248	WCG75E	252
P916.120	333	P949.025	57	P991.010	344	RE15.095-9	248	WCT708E	274
P917.080	333	P949.030	57	P991.108	344	SAC-SQ5-06	223	WDM120E	266
P918.000	333	P949.035	57	P991.112	344	SE1000	264	WDM360E	266
P919.000	321	P949.040	57	P992.040	354	SE500	264	WFP7E	252
P920.001	321	P951.010	337	P992.045	354	T400780	84	WKS800E	267
P920.002	321	P951.015	337	P992.050	354	T400880	84	WPG150E	277
P920.003	321	P951.019	337	P994.020	50	T401080	84	WPG250E	277
P921.001	321	P951.024	337	P994.022	50	T401280	84	WSB2W	255
P922.000	321	P952.001	337	P994.024	50	T7206	331	WSB33XE	255
P922.100	321	P952.002	337	P994.026	50	TBB145E	259	WSB40E	255
P923.000	321	P952.003	337	P994.030	50	TBB160E	259	WSB50E	254
P923.001	321	P953.000	97	P994.032	50	TBB175E	259	WSB50ST	254
P924.001	322	P953.001	337	P994.034	50	TR11	184	WSB55E	254
P924.002	322	P953.002	337	P994.036	50	TR11 G	186	WSB55ST	254
P924.002A	322	P953.003	337	P994.038	50	TR11 GG	186	WSB60E	254
P924.002R	322	P953.004	337	P994.040	50	TR11 GGG	186	WSB60ST	254
P924.002V	322	P953.005	337	P994.042	50	TR11 GGGG	186	WSB65E	254
P925.001	219	P954.013	95	P994.046	50	TR11 GGGGG	186	WSB65ST	254
P925.001	322	P954.015	95	P994.050	50	TR12	185	WSB70E	254
P925.002	219	P954.020	95	P994.055	50	TR12 H	187	WSB70ST	254
P925.002	322	P954.025	95	P994.065	50	TR12 HH	187	WSBPPCE	254
P929.025	57	P955.010	70	P994.080	50	TR12 HHH	187	WSG30E	268
P929.028	57	P955.012	70	P994.090	50	TR12 HHHH	187	WSG60E	268
P929.030	57	P955.015	70	P995.010	50	TR12 HHHHH	187	WW180E	283
P929.036	57	P955.017	70	P995.016	50	TR13	185	WW200E	283
P929.040	57	P955.020	70	P995.020	50	TR13 KKKK	190	WWCM180E	283
P937.000	109	P958.010	93	P995.026	50	TR13 KKKKK	190	XMIX0702	250
P938.000	114	P958.012	93	P995.030	50	TR13 KKKKKK	190	XMIX0703	250
P94.500.250	247	P958.014	93	P995.034	50	TR13 M	187	XMIX0704	250
P940.000	97	P958.016	93	P995.036	50	TR13 MM	187	XMIX0705	250
P940.090	97	P958.018	93	P995.038	50	TR13 MMM	187		
P940.120	97	P959.025	338	P995.040	50	TR13 MMMM	187		
P941.000	97	P959.030	338	P995.042	50	TR16	190		
P941.013	70	P959.035	338	P995.050	50	TR16 B	190		
P941.015	70	P959.040	338	P995.060	50	TR16 BB	190		
P941.018	70	P959.045	338	P997.014	50	TR16 BBB	190		
P941.020	70	P959.050	338	P997.016	50	TR16 BBBB	190		
P941.022	70	P960.225	339	P997.028	50	TR18	184		
P941.024	70	P960.230	339	P997.032	50	TR18 J	186		
P941.028	70	P960.235	339	P997.036	50	TR18 JJ	186		
P942.000	96	P962.002	289	P997.040	50	TR18 JJJ	186		
P943.000	96	P962.003	289	P998.035	51	TR18 JJJJ	186		
P944.000	97	P963.025	57	P998.050	51	TR18 JJJJJ	186		
P945.037	92	P963.030	57	P998.070	51	TR21	196		
P945.050	92	P963.035	57	P999.000	51	TR22	196		
P945.051	92	P963.040	57	RE 937.001	109	TR23	196		
P946.001	95	P964.001	113	RE 937.002	109	TR30	196		
P946.002	95	P970.000	91	RE 937.003	109	TR33	191		
P946.003	95	P972.060	58	RE 940.001	97	TR4	190		
P946.004	95	P975.000	114	RE 941.001	97	TR4 D	190		
P947.033	124	P975.100	114	RE 964.100	113	TR4 DD	190		
P947.038	124	P975.500	115	RE 964.200	113	TR4 DDD	190		
P947.043	124	P975.600	115	RE 975.001	114	TR4 DDDD	190		
P947.101	124	P975.900	111	RE 975.002	114	TR5	190		
P947.102	124	P977.015	58	RE 975.101	114	TR5 A	190		
P947.103	124	P979.000	344	RE 975.102	114	TR5 AA	190		
P947.301	124	P979.100	344	RE 975.901	111	TRA	190		
P947.302	124	P979.200	344	RE15.095-1	248	TRB	190		
P947.303	124	P980.000	121	RE15.095-10	248	TRD	190		
P947.400	125	P980.050	121	RE15.095-11	248	TRG	184		
P947.500	125	P980.200	121	RE15.095-2	248	TRH	185		
P947.600	125	P980.400	123	RE15.095-3	248	TRICE 16	190		
P947.700	125	P981.400	122	RE15.095-4	248	TRICE 25	190		
P948.066	58	P981.500	122	RE15.095-5	248	TRICE 36	190		

# CONDICIONES GENERALES DE VENTA / GENERAL SELLING CONDITIONS /

ESPAÑOL

## CONDICIONES DE VENTA

### RESERVA DE DOMINIO

PUJADAS se reserva el derecho de propiedad de todos los materiales suministrados hasta el cumplimiento íntegro del pago de los mismos.

### PRECIOS

Los precios de venta son los que figuran en nuestras tarifas y se refieren para la mercancía situada en nuestros almacenes de Santa Coloma de Farners con embalaje de cartón no retornable.

### PORTES

Todos los pedidos de ámbito Península y Baleares con un valor superior a 500 € (1.000 € en Canarias), se enviarán a portes pagados. Resto de países a consultar.

Pedidos de importe inferior podrán viajar con porte a cargo de PUJADAS mediante recargo del 4% en factura del valor neto del pedido con un mínimo de 10 €.

### CANTIDADES

Los materiales serán suministrados por embalajes completos conteniendo las cantidades indicadas en nuestras tarifas.

### DEVOLUCIONES

Sólo se admitirán las devoluciones aceptadas previamente por PUJADAS, en embalajes completos, etiquetados y referenciados. Para la aceptación de la misma será necesario remitir el formulario PUJADAS de devolución, firmado por el comercial de PUJADAS asignado y autorizado por Dirección Comercial. En caso de devolución por error en el pedido, o por razones ajenas a PUJADAS, la mercancía y el embalaje de la misma deberán encontrarse en condiciones para su reventa y estar referenciada en la tarifa vigente. La mercancía será abonada a su valor neto cargándose un demérito del 10% en concepto de participación en los costes de revisión y manipulado, descontándose si ha lugar el coste del embalaje y su acondicionamiento. En ningún caso se admitirán devoluciones de materiales que hayan sido utilizados.

Tampoco se admitirá la devolución de aquellos materiales en los que PUJADAS haya realizado alguna adaptación específica para el pedido. Las devoluciones o envíos de materiales a las instalaciones de PUJADAS ya sea para su abono, sustitución o reparación deberán efectuarse siempre a portes pagados.

Las devoluciones de ESTANTERIAS se efectuarán sólo en embalajes completos, sobre palet si es más de un embalaje y con protección de film plástico sobre el mismo.

Las devoluciones de CARROS se harán sobre palet y con embalaje protector completo.

### RECLAMACIONES

En ningún caso se aceptarán reclamaciones sobre el estado de la mercancía o sobre errores de envíos una vez pasados 15 días laborales desde su recepción.

### REPARACIONES

La reparación o reposición de materiales defectuosos se realizará sin cargo sólo cuando esté dentro del periodo de garantía. Nuestros productos están garantizados por el plazo de dos años (un año en el caso de la maquinaria). En todos los casos en que resulte exigible la garantía nuestra responsabilidad se limita a la entrega gratuita de un nuevo producto que sustituya al averiado o al reembolso íntegro del precio del producto afectado, quedando expresamente excluida cualquier responsabilidad por daños y perjuicios o cualesquiera otros gastos, cargos o indemnizaciones.

### FOTOS, DATOS Y MEDIDAS

Las fotos, datos y medidas de este catálogo pueden cambiar, sin previo aviso por exigencias técnicas o de producción.

### LEY APLICABLE Y JURISDICCION COMPETENTE

Las partes de estas Condiciones Generales de Venta acuerdan expresamente que cualquier litigio en relación con las mismas sea sometida a la jurisdicción de los tribunales de Barcelona (España) y que la Ley aplicable sea la Ley española.

ENGLISH

## GENERAL SELLING CONDITIONS

### TITLE RETENTION

PUJADAS reserves ownership rights over all the materials supplied until full payment of the same.

### PRICES

The selling prices are those specified in our rates, in reference to the merchandise in our warehouse of Santa Coloma de Farners with non-returnable cardboard packaging.

### FREIGHT

All orders made from the area of the Peninsula and the Balearic Islands with a value over 500 € (1.000 € in Canary Islands), shall be shipped prepaid. The remaining countries should consult regarding the same.

Orders with a lower value may be shipped with freight collect chargeable to PUJADAS for a surcharge of 4% over the net worth of the invoice on a minimum order of 10 €.

### QUANTITY

The materials will be supplied in complete packaging containing the quantity indicated in our rates.

### RETURNS

PUJADAS shall only admit returns which it has previously accepted, in complete packaging, labelled and indexed. In order to accept the same it will be necessary to remit the PUJADAS return form, signed by the salesperson of PUJADAS, settled and authorized by Business Management.

In case of return due to mistake in the order, or due to reasons not attributable to PUJADAS, the merchandise and the packaging thereof should be in conditions for resale and be indexed at the rate in force. The merchandise shall be paid at its net worth, charging a depreciation of 10% for sharing in costs of inspection and handling, discounting, as the case may be, the cost of packaging and the condition thereof.

Under no circumstances shall the return of materials which have been used be admitted.

Neither shall the return of materials be admitted in which PUJADAS has performed some specific adaptation to comply with the order.

The returns or shipments of materials to the facilities of PUJADAS whether for payment, replacement or repair should always be made by prepaid freight. The return of SHELVING shall only be performed in complete packaging, on pallets if it is more than one packaging and with plastic film protection over the same.

The return of TROLLEYS shall be made on pallets and with complete protective packaging.

### CLAIMS

Under no circumstances shall claims concerning the condition of the merchandise or regarding shipping mistakes be accepted once 15 workdays have elapsed since the reception thereof.

### REPAIRS

The repair or replacement of defective materials shall be performed without charge only when it is within the warranty period. Our products are guaranteed for a two year term (one year for machinery).

In all cases in which the warranty turns out to be enforceable, our liability is limited to the free delivery of a new product in substitution for the damaged product or full reimbursement of the price of the affected product, expressly excluding hereby any liability for consequential damages or any other expenses, charges or indemnities.

### PHOTOS, DATA AND MEASUREMENTS.

The photos, data and measurements in this catalogue are subject to change, without prior notice, due to technical or production requirements.

### GOVERNING LAW AND JURISDICTION

The parties to these General Selling Conditions agree that they shall be governed and interpreted according to the laws of Spain and both parties hereby expressly submit to the jurisdiction of the Courts of Barcelona (Spain), in respect of any proceedings arising out of or in connection with the present General Selling Conditions.



# CONDITIONS GENERALES DE VENTE / GENERELLE VERKAUFSBEDINGUNGEN

FRANÇAIS

## CONDITIONS GENERALES DE VENTE

### RÉSERVE DE PROPRIÉTÉ

PUJADAS se réserve le droit de propriété sur toutes les marchandises fournies jusqu'au paiement total de celles-ci.

### PRIX

Les prix de vente sont ceux qui figurent sur nos tarifs et font référence à la marchandise se trouvant dans nos entrepôts de Santa Coloma de Farners sous emballage en carton non retournable.

### PORTS

Toutes les commandes sur la Péninsule et les Baléares d'une valeur supérieure à 500 € (1.000 € pour les Canaries) seront envoyées en port payé. Pour les autres pays, veuillez consulter. Les commandes inférieures pourront être expédiées avec port à la charge de PUJADAS moyennant une majoration sur facture de 4% de la valeur nette de la commande et pour un minimum de 10 €.

### QUANTITÉS

Les marchandises seront fournies par emballages complets contenant les quantités indiquées sur nos tarifs.

### RETOURS

Seuls seront admis les retours préalablement acceptés par PUJADAS, dans des emballages complets, étiquetés et référencés. Pour l'acceptation de ces derniers, il faudra remettre le formulaire PUJADAS de retour, signé par le commercial de PUJADAS assigné et autorisé par la Direction Commerciale. En cas de retour pour erreur sur la commande ou pour des raisons indépendantes de la volonté de PUJADAS, la marchandise avec son emballage devront être en condition de revente et elle devra être référencée sur le tarif en vigueur. La marchandise sera créditée à concurrence de sa valeur nette en appliquant une dépréciation de 10% à titre de frais de révision et de manutention et en décomptant s'il y a lieu le coût de l'emballage et de son conditionnement.

Les retours de marchandises ayant été utilisées ne seront en aucun cas acceptés.

Le retour de marchandises sur lesquelles PUJADAS aura réalisé une quelconque adaptation spécifique à la commande ne sera pas non plus accepté.

Les retours ou envois de marchandises aux installations de PUJADAS, que ce soit pour être créditées, remplacées ou réparées, devront être toujours effectués en port payé.

Les retours d'ÉTAGERES ne seront effectués que sous emballages complets, sur palette s'il y a plus d'un emballage, et protégés à l'aide d'un film plastique tout autour.

Les retours de CHARIOTS seront effectués sur palette et sous emballage protecteur complet.

### RÉCLAMATIONS

Les réclamations sur l'état de la marchandise ou pour erreur d'envoi ne seront en aucun cas acceptées après écoulement d'un délai de 15 jours ouvrables à compter de la date de réception.

### RÉPARATIONS

La réparation ou le remplacement de marchandises défectueuses seront effectués sans frais dès l'instant que la période de garantie sera en vigueur. Nos produits sont garantis pendant une période de deux ans (un an pour les machines).

Dans tous les cas où la garantie sera exigible, notre responsabilité se limitera à la livraison gratuite d'un nouveau produit remplaçant le produit défectueux ou au remboursement du produit affecté, toute autre responsabilité en dommages-intérêts ou tout autre frais, dédit ou indemnisation étant expressément exclus.

### PHOTOGRAPHIES, DONNÉES ET DIMENSIONS

Les photos, données et dimensions de ce catalogue peuvent changer sans préavis suite à des impératifs techniques ou de production.

### JURIDICTION COMPÉTENTE ET LOI APPLICABLE

Pour le règlement des litiges, les deux parties s'en remettent expressément aux Tribunaux de Barcelone (Espagne), comme juridiction compétente étant la Loi applicable la Loi Espagnole.

DEUTSCH

## VERKAUFSBEDINGUNGEN

### Eigentumsrecht

PUJADAS behält sich das Eigentumsrecht an allen gelieferten Materialien bis zur vollständigen Bezahlung derselben.

### PREISE

Die Verkaufspreise sind in unseren Tarifen festgeschrieben und beziehen sich auf die Ware in unserem Lager in Santa Coloma de Farners mit Kartonverpackung nicht rücksendbar.

### LIEFERUNG

Alle Bestellungen auf der Halbinsel Spanien und den Balearen mit einem Wert über 500 € (1.000 € Kanarische Inseln) werden bei Vorauszahlung Frachtkostenfrei geliefert. Bei Lieferungen in andere Ländern fragen Sie bitte nach. Bestellungen unterhalb des Wertes können auf Kosten von PUJADAS geliefert werden mit einem Preiszuschlag von 4% des Nettobestellwertes bei einem Mindestbestellwert von 10 €.

### MENGEN

Die Produkte werden in kompletten Verpackungen geliefert, welche die in unseren Tarifen angegebenen Mengen beinhalten.

### RÜCKGABE

Rücksendungen, in kompletten Verpackungen, etikettiert mit Referenznummern, werden nur angenommen, wenn PUJADAS diese vorher akzeptiert hat. Für die Akzeptierung ist es nötig das Rückgabeformular von PUJADAS zu schicken, welches vom zugeteilten PUJADAS Vertreter unterschrieben sein soll und durch die Verkaufsleitung autorisiert.

In Fall der Rückgabe wegen Falschbestellung oder aus nicht von Pujadas zu vertretenen Gründen, muss die Ware und die Verpackung in einem wiederverkäuflichen Zustand sein und in den aktuellen Tarifen aufgelistet sein. Die Ware wird in seinem Nettowert erstattet mit einer Reduzierung von 10% an Bearbeitungs- und Kontrollkosten, in manchen Fällen können die Verpackungs- und Bereitstellungskosten auch abgezogen werden. In keinem Fall wird die Rückgabe von Materialien zugelassen, die schon gebraucht wurden. Es wird auch keine Rückgabe von Materialien zugelassen, die von PUJADAS teilweise speziell für die Bestellung angefertigt wurden. Die Frachtkosten für die Rückgabe oder Rücksendung der Materialien zu den Einrichtungen von PUJADAS, sei es wegen seiner Gutschrift, Ersetzung oder Reparatur müssen immer bezahlt sein. Die Rückgabe der Regale werden nur mit seiner kompletten Verpackung akzeptiert. Sind es mehr Verpackungen, müssen diese auf einer Palette mit einer Verpackungsfolie zusammen verpackt sein. Die Rückgabe der Wägen hat auf einer Palette mit der kompletten Schutzhülle zu erfolgen.

### REKLAMATIONEN

Auf keinen Fall werden Reklamationen wegen dem Zustand der Waren oder Falschlieferungen 15 Werktagen nach Erhalt der Waren akzeptiert.

### REPARIERUNGEN

Die Reparatur oder Ersetzung von defekten Waren erfolgt nur innerhalb des Garantiezeitraums ohne Kosten. Die Garantiedauer unserer Produkte beträgt zwei Jahre (1 Jahr im Falle von Maschinen). In allen Garantiefällen, beschränkt sich unsere Verantwortung auf die kostenlose Lieferung eines neuen Produktes, welches das Defekte ersetzt oder auf die Zurückerstattung des Wertes des betroffenen Produktes. Die Haftung für Schäden, Folgeschäden oder irgendwelche andere Kosten, Gebühren oder Wiedergutmachungen ist ausdrücklich ausgeschlossen.

### FOTOS, DATEN UND GRÖSSEN

Fotos, Daten und Grössen im Katalog können sich ohne vorherige Ankündigung aus technischen Gründen oder aus Produktionsanforderungen ändern.

### ANWENDBARES RECHT UND ZUSTÄNDIGER GERICHTSSTAND

Die Parteien dieser generellen Verkaufsbedingungen erklären sich ausdrücklich damit einverstanden, dass im Streitfall, der zuständige Gerichtsstand in Barcelona (Spanien) sein wird und das anzuwendende Recht, das spanische Recht ist.



## **The Vollrath Company, L.L.C. Headquarters**

1236 North 18th Street  
Sheboygan, Wisconsin 53081-3201 USA  
Customer Service: 920.457.4851  
Fax: 920.459.6573  
Credit: 920.459.5387

## **Vollrath Pujadas SAU EMEA**

Ctra. de Castanyet, 132  
17430 Sta. Coloma de Farners (Girona) - Spain  
Tel: +34 972.84.32.01  
email: info@pujadas.es

## **Vollrath of China**

Vollrath Shanghai Trading Limited  
29D, 855 South Pu Dong Road  
Shanghai, China 200120  
Tel: 86-21-50589580

## **Vollrath de Mexico S. de R.L. de C.V.**

Periferico Sur Edificio 2-C  
Col. Santa María Tequepexpan  
45601 Tlaquepaque, Jalisco Mexico  
Tel: (52) 333.133.6767 or (52) 333.133.6769  
Fax: (52) 333.133.6768

**pujadas.es**

**pujadas®**

A VOLLRATH® COMPANY

**PROFESSIONAL COOKWARE**