

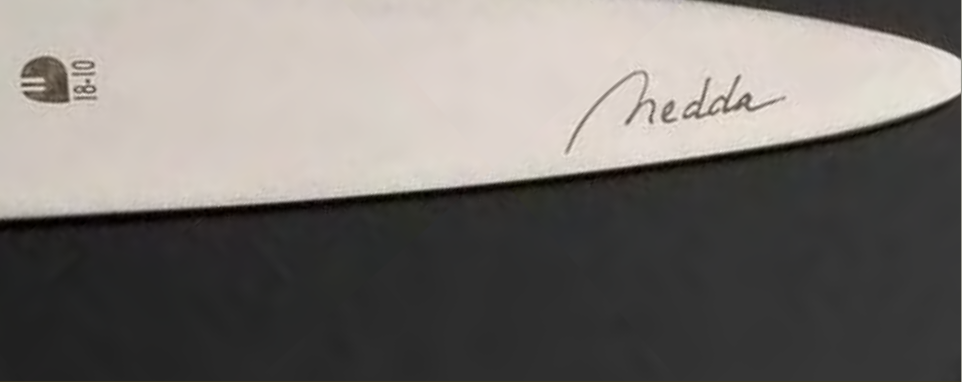

eternum 
created 1924



Content
Sommaire
Inhoud
Inhalt
Contenuto
Contenido
Spis treści
Содержани
Περιεχόμενα



Who are we?	3
Qui sommes-nous?	9
Wie zijn we?	15
Wer sind wir?	21
Chi siamo?	27
¿Quiénes somos?	33
Kim jesteśmy?	39
О н а с ?	45
Ποιοι ήμαστε?	51

Hotel reference list Références hôtelières Referentielijst hotels Hotelreferenzen Elenco di riferimento hotel Lista de referencia de hoteles Lista referencyjna hotelu Κατάλογος Отели – наши клиенты Ξενοδοχείων αναφοράς	57
--	----

Cutlery Eternum Signature Couverts Eternum Signature Bestek Eternum Signature Besteck Eternum Signature Marchio Posateria Eternum Cubertería Eternum Signature Sztućce Eternum Signature Столовые приборы Eternum Signature Μαχαιροπήρουνα Eternum Signature	59
--	----

Cutlery Eternum Couverts Eternum Bestek Eternum Besteck Eternum Posateria Eternum Cubertería Eternum Sztućce Eternum Столовые приборы Eternum Μαχαιροπήρουνα Eternum	81
--	----

Tableware Eternum Signature Articles de table Eternum Signature Tafelartikelen Eternum Signature Tischaccessoires Eternum Signature Marchio Vasellame Eternum Artículos de mesa Firma Eternum Zastawa stołowa Eternum Signature Столовая посуда Eternum Signature Επιτραπέζια σκεύη Eternum Signature	104
---	-----

Tableware Eternum Articles de table Eternum Tafelartikelen Eternum Tischaccessoires Eternum Artículos de mesa Vasellame Eternum Zastawa stołowa Eternum Столовая посуда Eternum Επιτραπέζια σκεύη Eternum	124
---	-----

Who are we?

Eternum
Your cutlery specialist
since **1924**

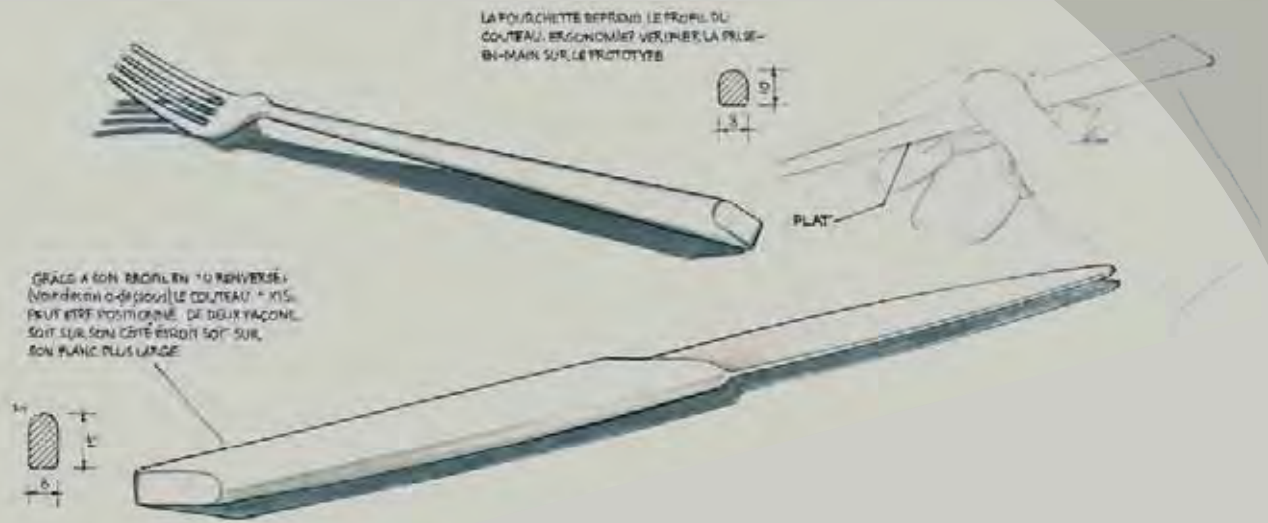

Eternum was established in 1924.

Our headquarters are in Gembloux, Belgium, where our Belgian production unit and a warehouse for 3000 pallets are located.

We are a 100% subsidiary of the Norwegian K.A. Rasmussen group (www.ka-rasmussen.no), a holding company specialised in the production and sale of noble metals for consumer and industrial markets.

Eternum focuses exclusively on stainless steel cutlery and accessories for table settings and buffets. Thanks to this specialised niche approach and our intensive product development policy we have developed into an important cutlery supplier at the international level.

We have a network of distributors and local representatives in 40 countries and our full selection is deliverable from stock.

Message from the Board of Directors

Dear Customer,

Eternum's vision and mission begin with you as customer, and our most important product is customer service. Service not only in the form of 98.7% delivery reliability*, but supplemented by that extra dimension that you as customer need now more than ever:

- the ability to quickly and flexibly respond to your questions and requirements,
- development of the right new products to increase your turnover and the satisfaction of your customers,
- strict management of our overhead expenses, allowing us to offer you quality at the right price.

We work daily to put this vision into practice in all aspects of the company, so that you can always count on the dedication of the whole Eternum team!

Always at your service,

Frank De Lombaert
Executive Director

Harald Sverdrup
Chairman, Board of Directors

*average service rating in 2009

Belgium, as a small country in the centre of Europe, is a melting pot of various influences, languages and cultures.

Therefore as a Belgian company we work primarily with Belgian designers, some of whom have developed a strong reputation at the international level.



*Nedda El Asmar,
Appetize Design*

<http://www.nedda.be>

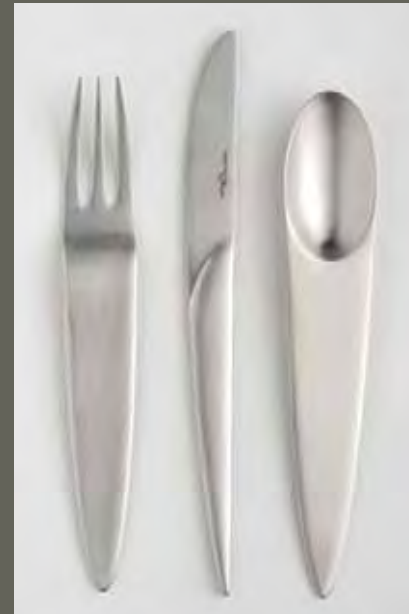

*Louis de Limburg,
Stirum Design*

<http://stirum-design.be>



eternum 
signature



Design within arm's reach



Eternum Signature is a high-quality collection for higher level hotels and restaurants.

- > Only 18/10 steel is used.
- > New models are always developed in collaboration with external designers.

eternum



The Eternum range fits perfectly into a casual dining environment.

- > 18/10 as well as 18/0 steel is used.
- > New models are designed either by external designers or by our internal design department.

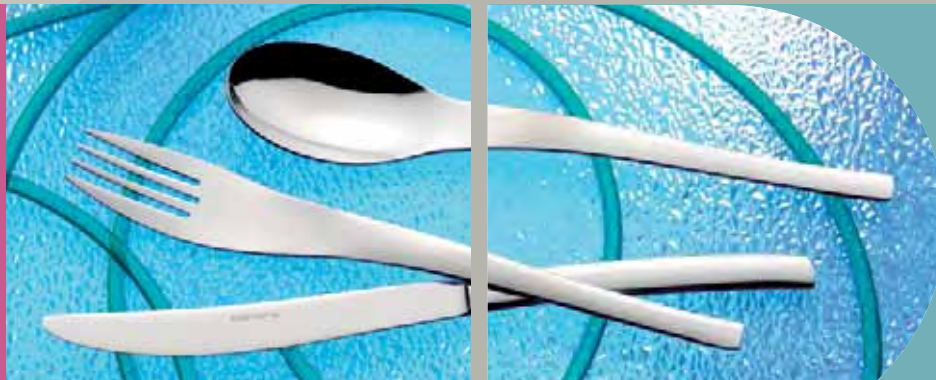

We can **personalise** your orders to fit your needs perfectly

Embossing

With or without re-polishing



Etching



Laser engraving



Diamond engraving



Matt re-polishing



Sand blasting



Silver plating

cutlery 33 or 40 microns
Table ware 10 or 15 microns



Gold plating



PVD coating

Anthracite

Food approved - Scratch resistant - Min. 400 pcs/colour



PVD coating

Gold

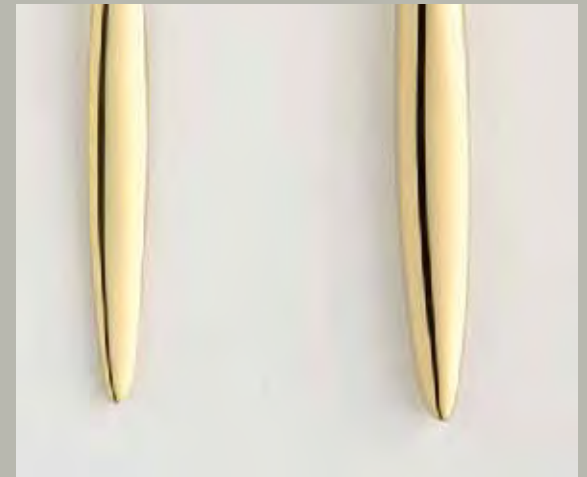

Qui sommes-nous ?

Eternum
Votre spécialiste en
couverts depuis **1924**

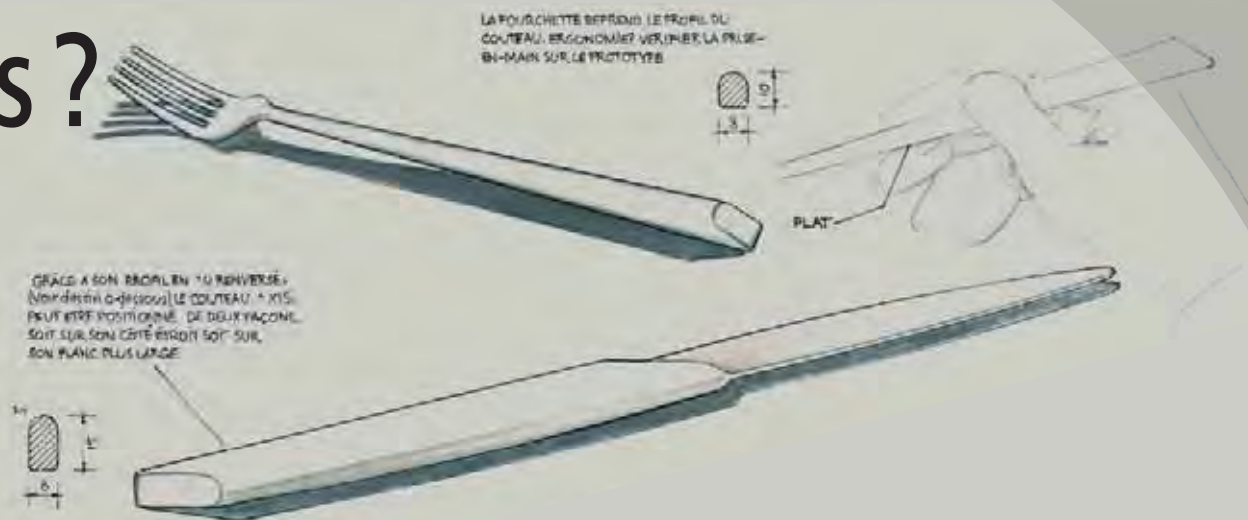

Eternum a été fondée en 1924.

Notre siège principal est établi à Gembloux (Belgique), où se situent également notre unité de production belge ainsi qu'un entrepôt de 3 000 palettes.

Nous sommes une filiale à 100% du groupe norvégien K.A.Rasmussen (www.ka-rasmussen.no), un holding spécialisé dans la production et la vente de métaux précieux destinés au marché des biens de consommation et l'industrie.

Eternum se concentre exclusivement sur les couverts et accessoires en inox pour la table et les buffets. Cette approche spécialisée, combinée à une stratégie de design intensive, nous a permis de devenir un des fournisseurs de couverts les plus en vue sur la scène internationale.

Nous sommes présents dans 40 pays à travers notre réseau de distributeurs et d'agents locaux, et tous nos articles sont livrables de stock.

Message du conseil d'administration

Cher client,

Chez Eternum, le service clientèle est le plus important des produits. Votre satisfaction est au cœur de notre vision et de notre mission.

Ce service ne se limite pas à un taux de fiabilité des livraisons de 98,7 %*, mais prend cette dimension supplémentaire dont, aujourd'hui plus que jamais, vous avez besoin :

- des réponses rapides et flexibles à vos questions et à vos besoins ;
- le choix de nouveaux designs qui dopent à la fois votre chiffre d'affaires et la satisfaction de vos clients ;
- une gestion rigoureuse de nos frais généraux afin de pouvoir vous offrir la qualité au juste prix.

Cette vision, nous nous efforçons de la mettre en pratique au quotidien, à chaque niveau de l'entreprise, de façon à ce que vous puissiez à tout moment compter sur l'enthousiasme et le dévouement de toute l'équipe d'Eternum.

À votre service,

Frank De Lombaert
Administrateur délégué

Harald Sverdrup
Président du Conseil
d'administration

* niveau de service moyen en 2009

Petit pays situé en plein cœur de l'Europe, la Belgique est un melting-pot d'influences, de langues et de cultures diverses.

En tant qu'entreprise belge, nous avons donc choisi de collaborer principalement avec des designers belges, dont certains se sont déjà forgé une réputation internationale.



*Nedda El Asmar,
Appetize Design*

<http://www.nedda.be>



*Louis de Limburg,
Stirum Design*

<http://stirum-design.be>



eternum signature



Le design à portée de main



Eternum Signature est une collection de qualité supérieure destinée aux meilleurs hôtels et restaurants.

- > Utilisation exclusive d'acier 18/10.
- > Les nouveaux modèles sont systématiquement créés en collaboration avec des designers externes.

eternum



La gamme Eternum est idéale pour des ambiances plus décontractées.

- > Utilisation d'acier 18/10 et 18/0.
- > Les nouveaux modèles sont créés soit par des designers externes, soit par notre département design interne.

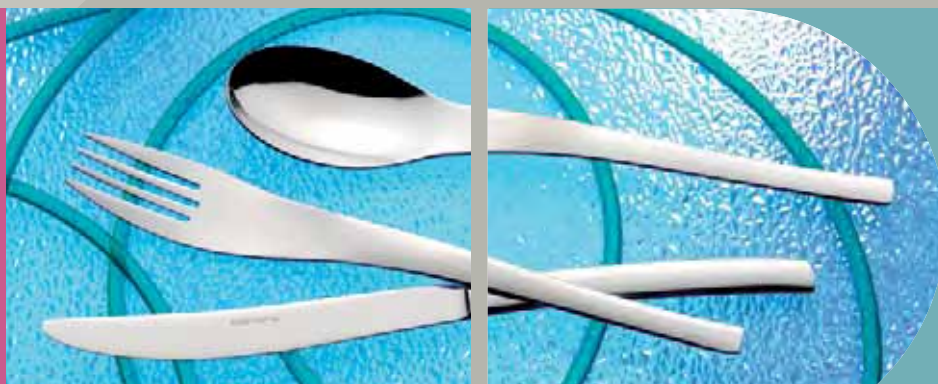

Nous **personnalisons** vos commandes pour vous fournir les couverts parfaitement adaptés à vos besoins

Poinçonnage
Avec ou sans repolissage



Électrolyse



Gravure au laser



Gravure au diamant



Repolissage mat



Sablage



Argenture

couverts 33 ou 40 microns
vaisselle 10 ou 15 microns



Dorure



Revêtement PVD

Anthracite

usage alimentaire - anti-rayures - min. 400 pcs/couleur



Revêtement PVD

Or



Wie zijn we?

Eternum Uw bestekspecialist sinds 1924

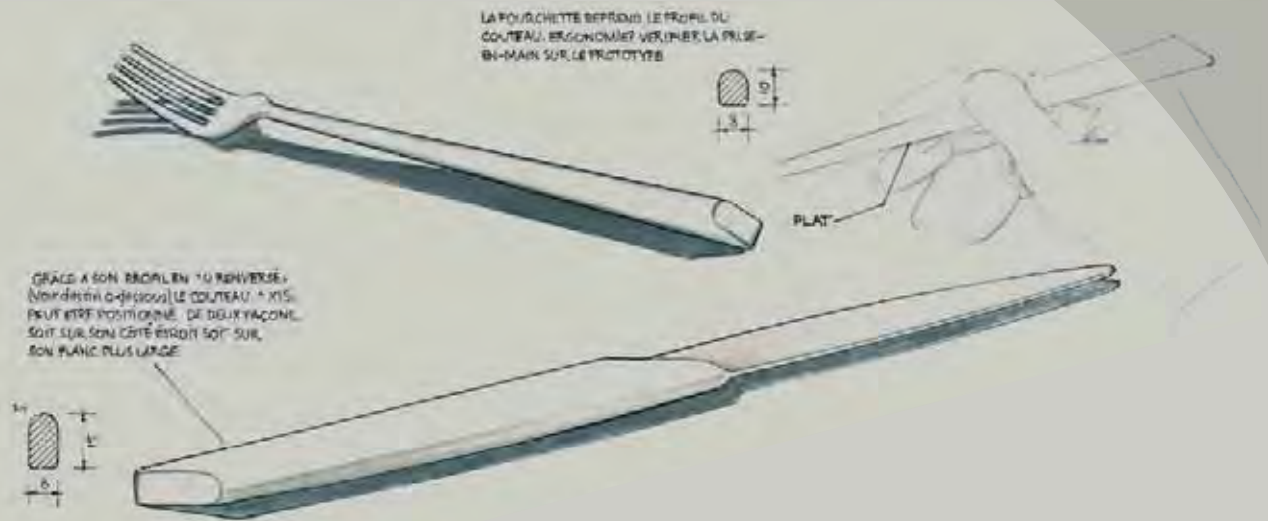

Eternum werd opgericht in 1924.

Ons hoofdkwartier is gevestigd in Gembloux, België, waar zich ook onze Belgische productie-unit en een warehouse voor 3000 palletten bevindt.

Wij zijn een 100% dochterbedrijf van de Noorse K.A.Rasmussen groep (www.ka-rasmussen.no), een holding gespecialiseerd in de productie en verkoop van edele metalen voor consumenten- en industriële markten.

Eternum focust zich uitsluitend op roestvrijstalen bestek en accessoires voor de gedekte tafel en buffetten. Dankzij deze gespecialiseerde niche-aanpak en ons intensief productontwikkelingsbeleid zijn wij uitgegroeid tot een belangrijke bestekleverancier op internationaal niveau.

Wij beschikken over een netwerk van distributeurs en lokale agenten in 40 landen en ons volledig assortiment is leverbaar uit voorraad.

Boodschap van de raad van bestuur

Beste Klant,

Eternum's visie en missie begint bij U als klant en ons belangrijkste product is klantenservice.

Service niet enkel in de vorm van 98,7 % leverbetrouwbaarheid*, maar versterkt met die extra dimensie die U als klant vandaag meer dan ooit nodig hebt:

- snel en flexibel op Uw vragen en behoeften kunnen inspelen,
- de juiste nieuwe producten ontwikkelen zodat U Uw omzet en de tevredenheid van Uw klanten ziet toenemen,
- strenge beheersing van onze overheadkosten om U kwaliteit te kunnen aanbieden tegen een correcte prijs.

Dagelijks werken wij aan het in de praktijk brengen van deze visie in alle lagen van de onderneming, zodat U permanent kan rekenen op de inzet van het ganse Eternum team!

Steeds tot Uw dienst,

Frank De Lombaert
Gedelegeerd bestuurder

Harald Sverdrup
Voorzitter Raad van Bestuur

* gemiddelde servicegraad in 2009

België, als klein land in het centrum van Europa, is een smeltkroes van diverse invloeden, talen en culturen.

Daarom werken wij als Belgische firma voornamelijk met Belgische ontwerpers, waarvan sommigen een sterke reputatie hebben opgebouwd op internationaal vlak.



*Nedda El Asmar,
Appetize Design*

<http://www.nedda.be>



*Louis de Limburg,
Stirum Design*

<http://stirum-design.be>



eternum
signature



Design binnen handbereik



Eternum Signature is een hoogwaardige collectie voor de betere hotels en restaurants.

- > Enkel 18/10 staal wordt gebruikt.
- > Ontwikkeling van nieuwe modellen gebeurt steeds in samenwerking met externe designers

eternum



Het Eternum assortiment past perfect in een casual dining omgeving .

- > Zowel 18/10 als 18/0 staal worden gebruikt.
- > Nieuwe modellen worden ofwel ontworpen door externe designers ofwel door onze interne designafdeling.



We kunnen uw bestellingen **personaliseren** om perfect aan uw behoeften te voldoen.

Stempelen

Met of zonder overpolijsting



Etsen (Elektrolyse)



Graveren laser



Graveren diamant



Matte overpolijsting



Zandstralen



Verzilveren

bestek 33 of 40 micron
tafelartikelen 10 of 15 micron



Vergulden



PVD coating

Antraciet

goedgekeurd voor voedsel - krasbestendig - min. 400 st./kleur



PVD coating

Goud

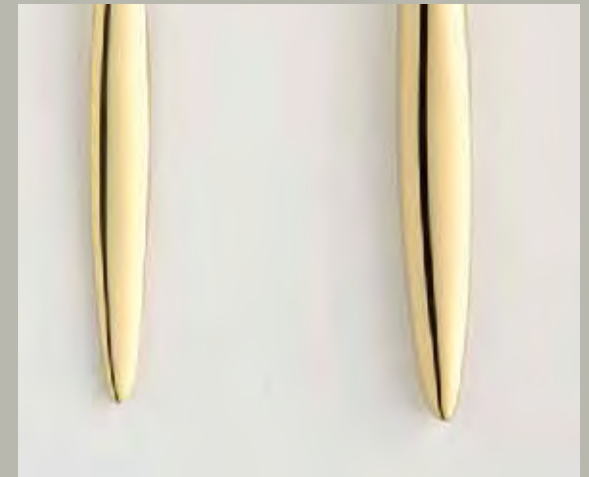

Belgien – als kleines Land im Zentrum Europas – ist ein Schmelztiegel verschiedener Einflüsse, Sprachen und Kulturen.

Deshalb arbeiten wir als belgisches Unternehmen hauptsächlich mit belgischen Designern, von denen einige eine starke internationale Reputation aufgebaut haben.



*Nedda El Asmar,
Appetize Design*

<http://www.nedda.be>

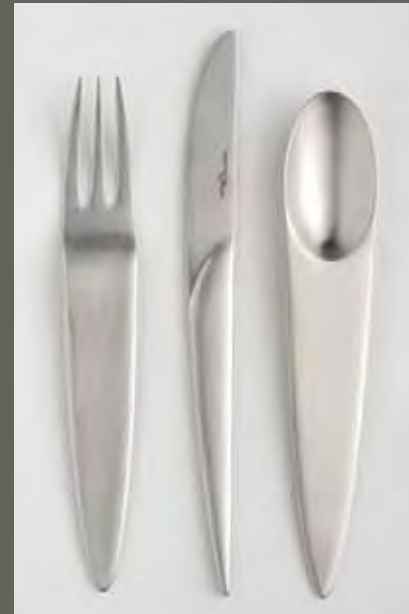

*Louis de Limburg,
Stirum Design*

<http://stirum-design.be>



eternum 
signature



Design in Reichweite



Eternum Signature ist eine hochwertige Kollektion für die besseren Hotels und Restaurants.

- > Es wird ausschließlich 18/10-Stahl verwendet.
- > Die Entwicklung neuer Modelle erfolgt stets in Kooperation mit externen Designern.

eternum



Das Eternum-Sortiment passt perfekt in eine ungezwungene gastronomische Umgebung.

- > Sowohl 18/10- als auch 18/0-Stahl werden verwendet.
- > Neue Modelle werden entweder von externen Designern oder von unserer internen Designabteilung entworfen.



Wir können Ihre Bestellungen **personalisieren**, damit sie völlig Ihren Bedürfnissen entsprechen.

Prägung

Mit oder ohne erneutem Polieren



Ätzung (Elektrolyse)



Lasergravur



Diamantgravur



Erneutes polieren matt Sandstrahlen



Versilberung

Besteck 33 oder 40 Mikron
Tischaccessoires 10 oder 15 Mikron



Vergoldung



PVD-Beschichtung Anthrazit

lebensmittelsicher - kratzfest - mind. 400 Stück/Farbe



PVD-Beschichtung Gold

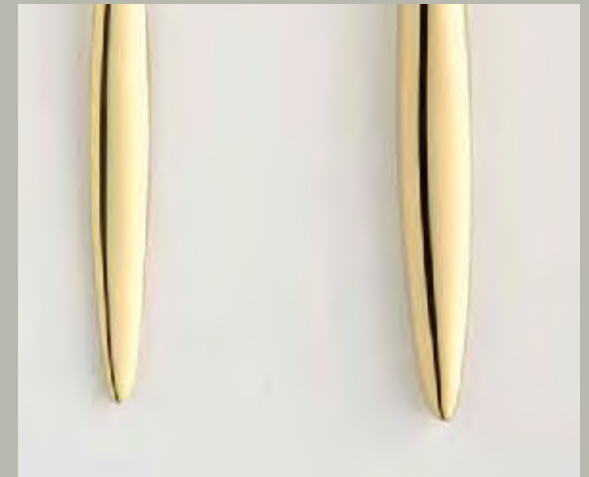

Chi siamo?

Eternum Specialista di posate dal 1924

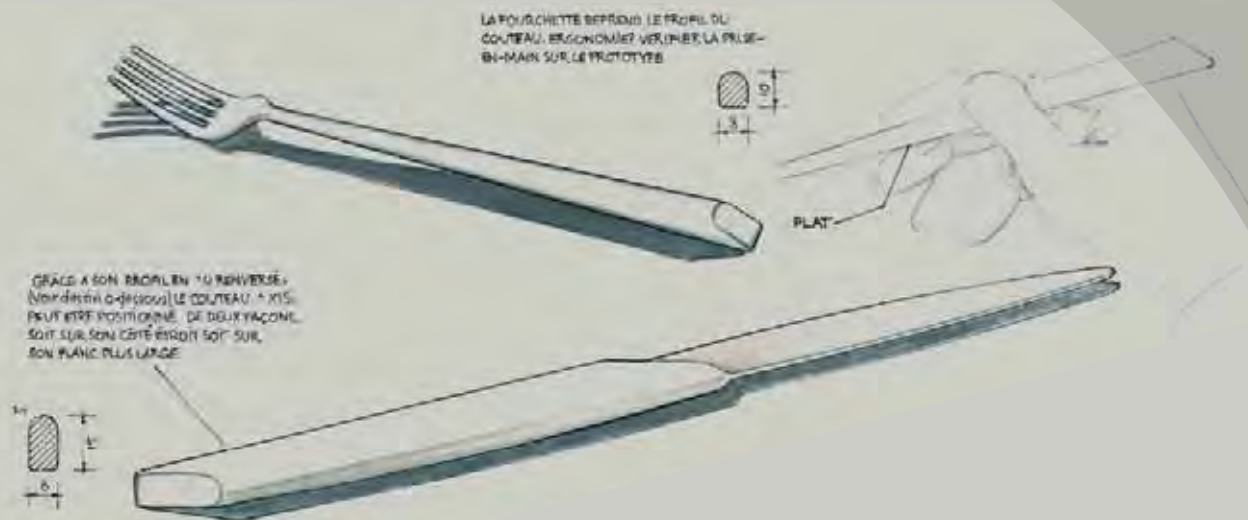

Eternum è stata fondata nel 1924.

La nostra sede si trova a Gembloux, in Belgio dove si trovano anche la nostra unità produttiva belga e un deposito per 3000 bancali.

La nostra azienda è una sussidiaria controllata al 100% dal gruppo norvegese K.A.Rasmussen (www.ka-rasmussen.no), una holding specializzata nella produzione e nella vendita di metalli nobili per il mercato al consumo e dell'industria.

Eternum si occupa esclusivamente della produzione di posate e di accessori per la tavola in acciaio inossidabile. Grazie al nostro approccio specializzato di nicchia e alla nostra intensa politica di sviluppo siamo diventati uno dei principali fornitori di posate a livello internazionale.

Disponiamo di una rete di distributori e di agenti locali in 40 paesi e l'intero assortimento è disponibile in pronta consegna.

Messaggio del Consiglio di amministrazione

Gentile Cliente,

La vision e la mission di Eternum iniziano proprio da Voi clienti, e il nostro prodotto più importante è il servizio alla clientela.

Questo servizio non si traduce solo nel 98,7% di affidabilità delle consegne*, ma si arricchisce di quella dimensione ulteriore che per Voi, nostri clienti, oggi è più importante che mai:

- ascoltare e saper rispondere alle Vostre richieste e necessità con prontezza e flessibilità,
- sviluppare i prodotti giusti che Vi consentano di aumentare la soddisfazione dei Vostri clienti e i Vostri ricavi,
- operare una gestione razionale dei costi per poterVi offrire qualità ad un giusto prezzo.

Ogni giorno lavoriamo per poter mettere in pratica la nostra filosofia a tutti i livelli dell'azienda, per far sì che possiate sempre contare sull'impegno dell'intero team Eternum!

Sempre al Vostro servizio,

Frank De Lombaert
Administrador Delegado

Harald Sverdrup
Presidente del Consejo
de Administración

* nivel de servicio medio en 2009

Il Belgio, paese piccolo nel cuore dell'Europa, è un incontro di tradizioni, lingue e culture diverse.

Per questo motivo la nostra azienda belga lavora prevalentemente con progettisti belgi, alcuni dei quali hanno raggiunto una notevole fama anche a livello internazionale.



*Nedda El Asmar,
Appetize Design*

<http://www.nedda.be>

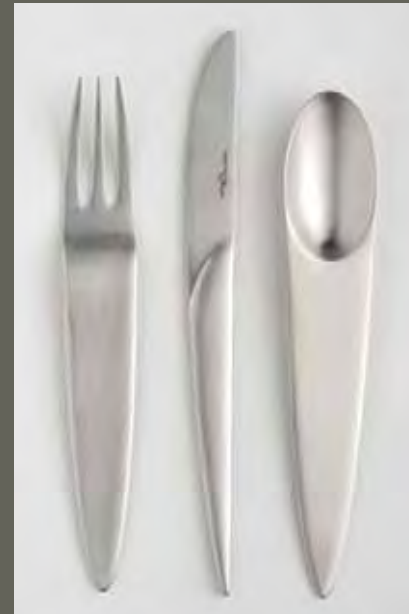

*Louis de Limburg,
Stirum Design*

<http://stirum-design.be>



eternum 
signature



Design a portata di mano



Eternum Signature è una collezione prestigiosa per i migliori alberghi e ristoranti.

- > Utilizza soltanto acciaio 18/10.
- > Lo sviluppo di nuovi modelli avviene sempre in collaborazione con designer esterni.

eternum



L'assortimento Eternum si adatta perfettamente al contesto di una cena informale.

- > Utilizza sia l'acciaio 18/10 che l'acciaio 18/0.
- > I nuovi modelli vengono elaborati da designer esterni o dal nostro reparto di progettazione.

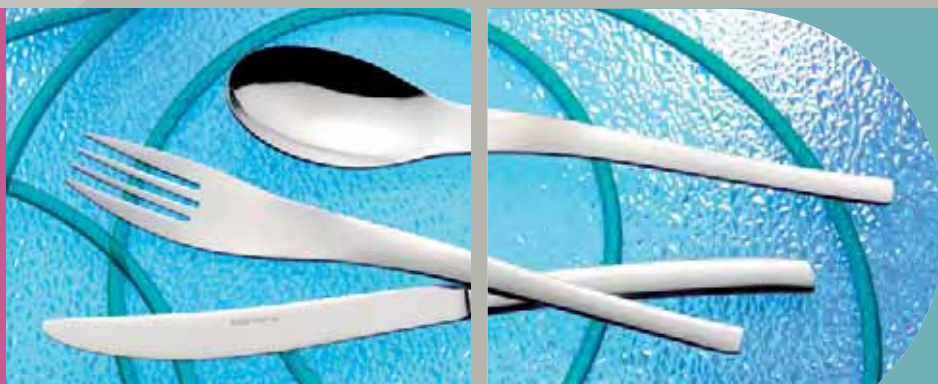

Possiamo **personalizzare** i suoi ordini per soddisfare al meglio le sue esigenze

Goffratura

Con o senza ri-lucidatura



Incisione all'acquaforte



Incisione a laser



Incisione diamante



Ri-verniciatura opaca Sabbiatura



Placcatura Argento

posateria 33 o 40 micron
vasellame 10 o 15 micron



Placcatura Oro

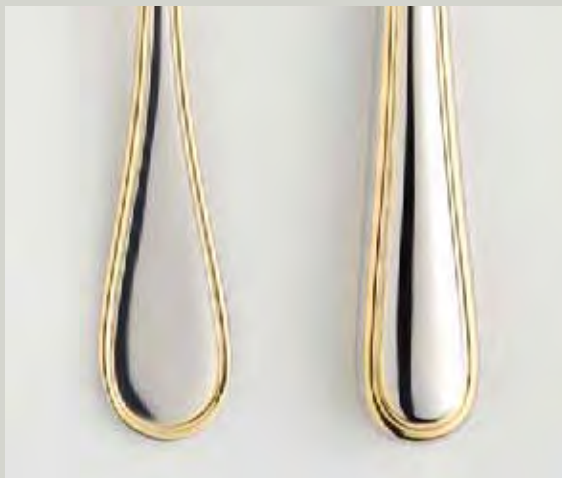

Rivestimento PVD

Antracite

per alimenti - resistente ai graffi - min. 400 pezzi/colore



Rivestimento PVD

Oro



¿Quiénes somos?

Eternum

Su especialista en cubiertos desde 1924

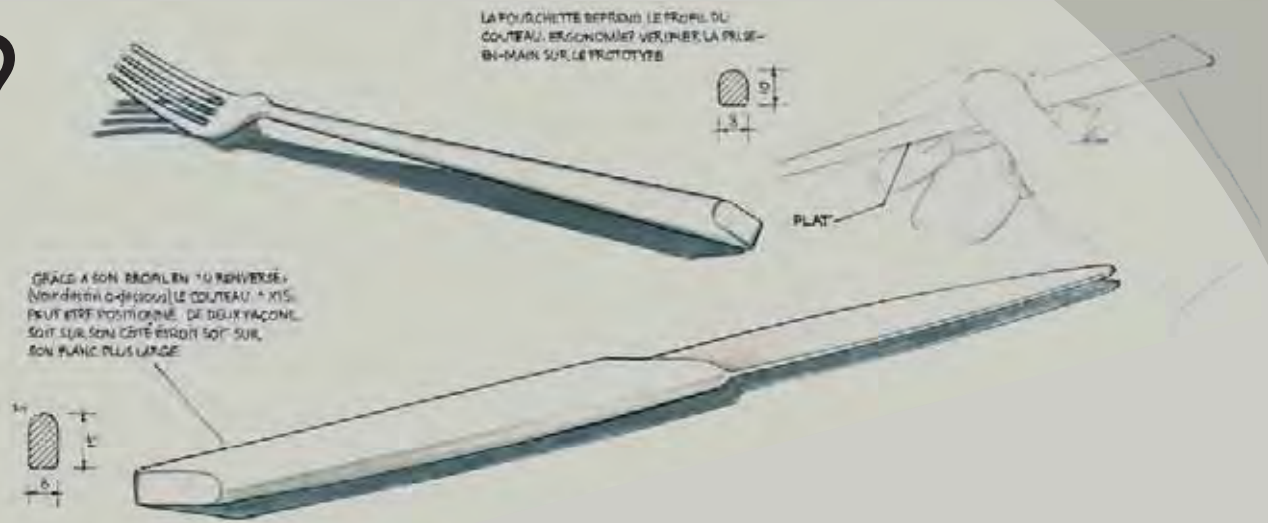

Eternum fue creada en el año 1924.

Nuestra sede principal está establecida en Gembloux (Bélgica) donde también se encuentra nuestra unidad de producción Belga y nuestro almacén con un espacio disponible para 3000 palets.

Somos una empresa filial al 100% del grupo Noruego K.A. Rasmussen (www.ka-rasmussen.no), un holding especializado en la producción y venta de metales nobles tanto para el consumidor directo como para los mercados industriales.

Eternum está centrado exclusivamente en la fabricación de cubiertos y accesorios en aceros inoxidables para la mesa y buffets. Esta especialización combinada con una estrategia de una gran variedad de diseños, nos ha permitido convertirnos en un proveedor a escala internacional.

Estamos presentes en 40 países a través de nuestra red de distribuidores y agentes locales y todos nuestros artículos están disponibles en nuestros almacenes.

Mensaje del consejo de administración

Estimado/a cliente/a:

La visión y la misión de Eternum comienza con usted como cliente y nuestro producto más importante es el servicio al cliente.

Servicio, no sólo en términos numéricos, con un 98,7% de fiabilidad a la hora de realizar las entregas*, sino un servicio reforzado con los detalles que usted como cliente necesita hoy más que nunca:

- rapidez y flexibilidad para responder a sus preguntas y necesidades;
- desarrollo de los productos nuevos adecuados para que usted vea aumentar tanto sus beneficios como la satisfacción de sus clientes;
- alto dominio de nuestros gastos indirectos para poder ofrecerle calidad a un precio correcto.

Nuestro trabajo diario se centra en llevar a la práctica esta visión en todos los niveles de la sociedad para que usted pueda contar con la dedicación de todo el equipo Eternum.

Siempre a su servicio,

Frank De Lombaert
Administrador Delegado

Harald Sverdrup
Presidente del Consejo
de Administración

* nivel de servicio medio en 2009

Como país pequeño en el centro de Europa, Bélgica es un crisol de influencias, idiomas y culturas.

Por eso, como empresa belga, trabajamos principalmente con diseñadores belgas, de los cuales algunos de ellos han alcanzado una gran reputación a escala internacional.



Nedda El Asmar,
Appetize Design

<http://www.nedda.be>



Louis de Limburg,
Stirum Design

<http://stirum-design.be>



eternum signature



Diseño al alcance de la mano



Eternum Signature es una colección de alta calidad para hoteles y restaurantes de nivel más alto.

- > Sólo se utiliza acero 18/10.
- > El diseño de los modelos nuevos siempre se lleva a cabo de la mano de diseñadores externos.

eternum



La gama Eternum encaja perfectamente en un entorno de cena informal.

- > Se utiliza tanto acero 18/10 como 18/0.
- > El diseño de los modelos nuevos se lleva a cabo de la mano de diseñadores externos o de nuestro departamento interno de diseño.



Podemos **personalizar** sus pedidos para satisfacer plenamente sus necesidades

Grabado en relieve
Con o sin repulido



Grabado al ácido
(Electrolisis)



Grabado con láser



Grabado con diamante



Repulido mate



Chorro de arena



Plateado

cutertería de 33 ó 40 micrómetros
artículos de mesa de 10 ó 15 micrómetros



Chapado en oro



Capa de PVD

Antracita

apto para la alimentación - resistente al rayado - mín. 400 u./color



Capa de PVD

Oro

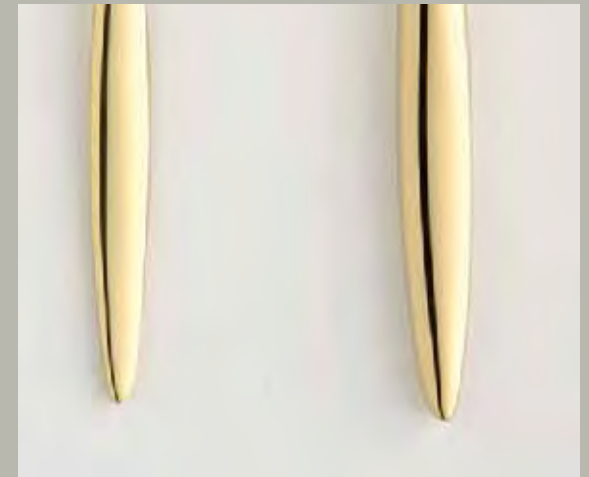

Kim jesteśmy?

Eternum Państwa specjalista w kreowaniu sztućców od 1924 r.

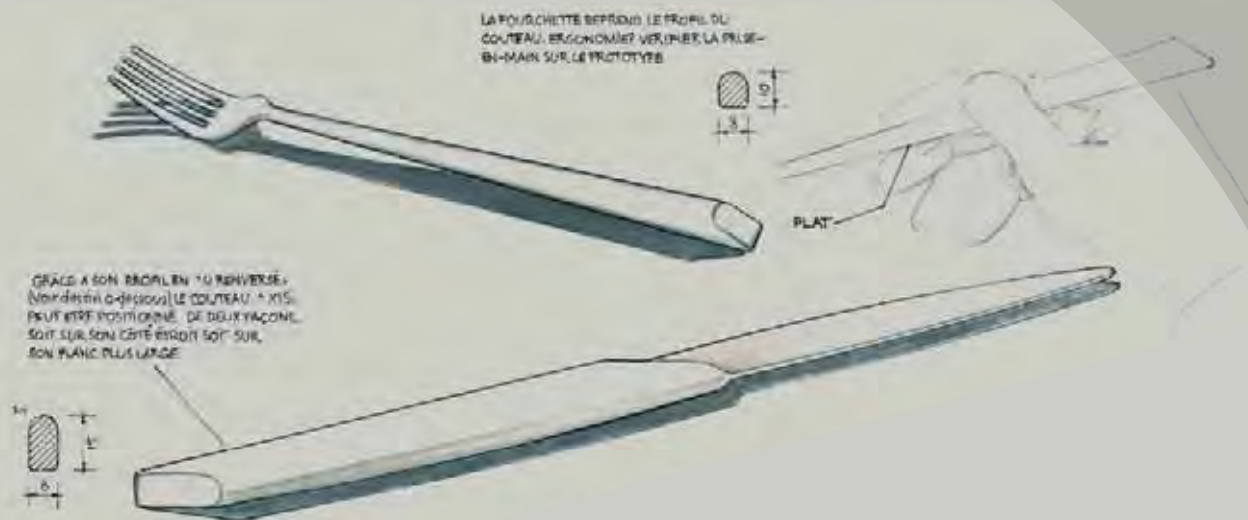

Firma Eternum została założona w 1924 r.

Nasza siedziba główna mieści się w belgijskiej miejscowości Gembloux, gdzie znajduje się również nasz belgijski oddział produkcyjny oraz magazyn na 3000 palet.

W 100% stanowimy spółkę-córkę norweskiej grupy K.A.Rasmussen (www.ka-rasmussen.no), holdingu specjalizującego się w produkcji i sprzedaży metali szlachetnych dla rynku konsumenckiego i przemysłowego.

Eternum koncentruje się wyłącznie na wyrobie sztućców i akcesoriów ze stali nierdzewnej do nakrycia stołu oraz bufetów. Dzięki takiemu niszowemu podejściu i naszej polityce intensywnego rozwijania produktów staliśmy się ważnym dostawcą sztućców na międzynarodowym poziomie.

Dysponujemy siecią dystrybutorów oraz lokalnych agentów w 40 krajach, a nasz cały asortyment dostarczamy ze statych zapasów magazynowych.

Wiadomość od zarządu

Szanowni Klienci,

Wizja i misja Eternum zaczyna się od Państwa, jako naszych Klientów, a naszym najważniejszym produktem jest obsługa Klienta.

Obsługa ta wyraża się nie tylko w niezawodności w dostawach na poziomie 98,7%*. Wzmacniają ją dodatkowe wartości, których Państwo, jako klienci, potrzebują dziś szczególnie. Są to:

- szybka i elastyczna reakcja na Państwa pytania i potrzeby;
- projektowanie odpowiednich nowych produktów tak, aby zwiększyć Państwa zyski i zadowolenie Państwa klientów;
- solidne zarządzanie naszymi kosztami ogólnymi, by móc zaoferować Państwu jakość za rozsądną cenę.

Każdego dnia staramy się urzeczywistnić naszą wizję na każdym poziomie przedsiębiorstwa tak, aby zawsze mogli Państwo liczyć na zaangażowanie całego zespołu Eternum!

Zawsze do Państwa dyspozycji,

Frank De Lombaert
Delegowany członek
zarządu

Harald Sverdrup
Prezes zarządu

* średni poziom usług w 2009 r.

Będąc niewielkim krajem w sercu Europy, Belgia stanowi tygiel różnych wpływów, języków i kultur.

Dlatego jako belgijska firma pracujemy w głównej mierze z belgijskimi projektantami, wśród których są osoby cieszące się doskonałą reputacją na szczeblu międzynarodowym.



*Nedda El Asmar,
Appetize Design*

<http://www.nedda.be>



*Louis de Limburg,
Stirum Design*

<http://stirum-design.be>



eternum signature



Design na wyciągnięcie dłoni



Eternum Signature to wysokiej jakości kolekcja dla hoteli i restauracji, o wysokich standardach.

- > Wykorzystywana jest wyłącznie stal 18/10.
- > Projektowanie nowych modeli odbywa się w ciągłej współpracy z projektantami z zewnątrz.

eternum



Asortyment Eternum idealnie pasuje do restauracji w segmencie „casual dining” .

- > Wykorzystywana jest stal 18/10 oraz 18/0.
- > Projektowaniem nowym modeli zajmują się projektanci z zewnątrz lub nasz wewnętrzny dział projektowania.

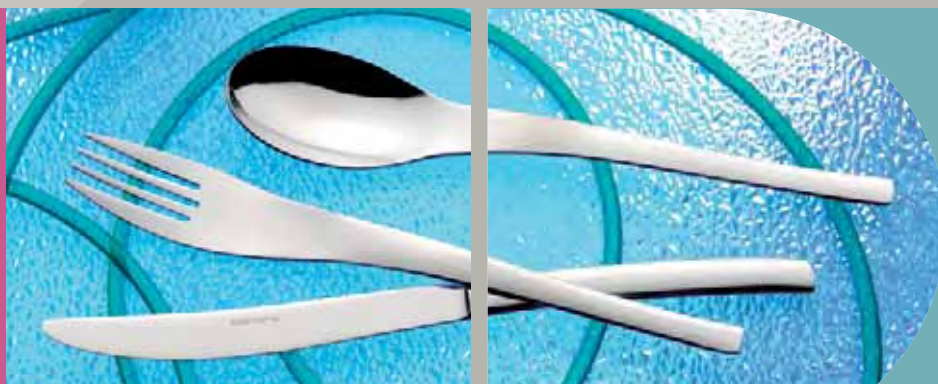

Możemy dostosować
zamówienia do
Państwa potrzeb

Wytłaczanie

*Z ponownym polerowaniem
lub bez polerowania*



Grawerowanie
laserowe



Wytrawianie (Elektroliza)



Grawerowanie
diamentem



Ponowne polerowanie matowe



Platerowanie złotem



Piaskowanie



Powłoka PVD *Antracyt*

dopuszczone do kontaktu z żywnością - odporne na zarysowania -
min. 400 sztuk/kolor



Platerowanie srebrem

sztućce 33 lub 40 mikrony
zastawa stołowa 10 lub 15 mikronów



Powłoka PVD *Złoto*



О нас?

Eternum

Ваш эксперт в
области столовой
посуды с **1924** года.



Обращение правления

Уважаемый Клиент!

Миссия компании Eternum начинается с Вас, нашего клиента, а важнейшим элементом нашей деятельности является обслуживание клиентов.

Такое обслуживание не только подразумевает надежность поставок на уровне 98,7%*, но и те дополнительные преимущества, которые сегодня как никогда нужны нашим клиентам:

- быстрое и гибкое решение Ваших вопросов и проблем,
- разработка именно такой продукции, благодаря которой Вы сможете увеличить свой оборот и в еще большей степени удовлетворить своих клиентов,
- строгий контроль наших накладных расходов, что дает нам возможность предложить Вам высокое качество по доступной цене.

Мы повседневно работаем над воплощением этих принципов на всех уровнях предприятия для того, чтобы Вы во всем и полностью могли положиться на профессиональный коллектив компании Eternum!

Всегда к Вашим услугам,

Франк Де Ломбарт
Полномочный директор

Харальд Свердруп
Председатель
Правления

* средний показатель за 2009 г.

Бельгия-небольшая страна в сердце Европы-является своеобразным котлом, в котором смешиваются различные течения, языки и культуры.

Поэтому, будучи бельгийской фирмой, мы работаем преимущественно с бельгийскими дизайнерами, некоторые из которых имеют отличную репутацию и на международной арене.



Nedda El Asmar,
Appetize Design

<http://www.nedda.be>



Louis de Limburg,
Stirum Design

<http://stirum-design.be>



eternum signature



Роскошный дизайн всегда под рукой



Eternum Signature – роскошная коллекция для дорогих отелей и ресторанов.

- > Используется только сталь 18/10.
- > Разработка новых моделей обязательно происходит с привлечением дизайнеров извне.

eternum



Коллекция Eternum отлично подойдет для неофициальной обстановки.

- > Используется сталь 18/10 и 18/0.
- > Новые модели разрабатываются либо с привлечением дизайнеров извне, либо нашим собственным дизайнерским отделом.

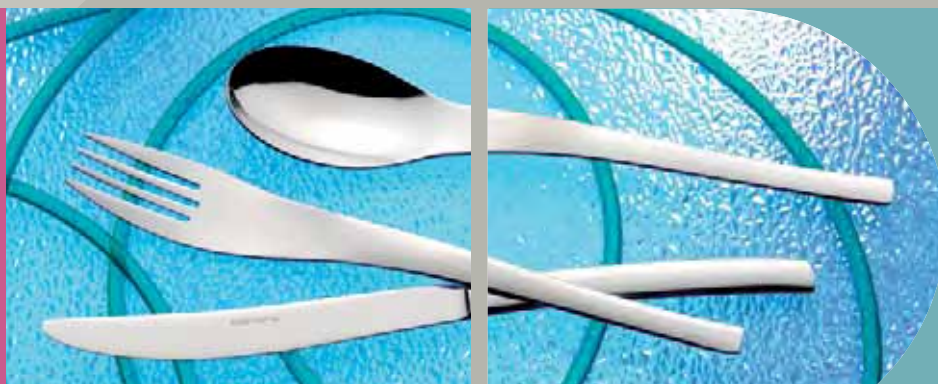

Мы поставим Вам именно такие товары, которые наиболее полно отвечают Вашим требованиям

Тиснение
С или без повторной полировки



Гравировка травлением
(Электролиз)



Лазерная гравировка



Алмазная гравировка



Матовая полировка



Пескоструйная обработка



Серебрение

Стальные приборы :33 или 40 микрон.



Золочение



Покрытие, нанесённое осаждением паров (PVD)

Антрацит

Золото

Допускается контакт с пищевыми продуктами- Устойчивое к царапинам-Мин. 400 моек в посудомоечной машине.

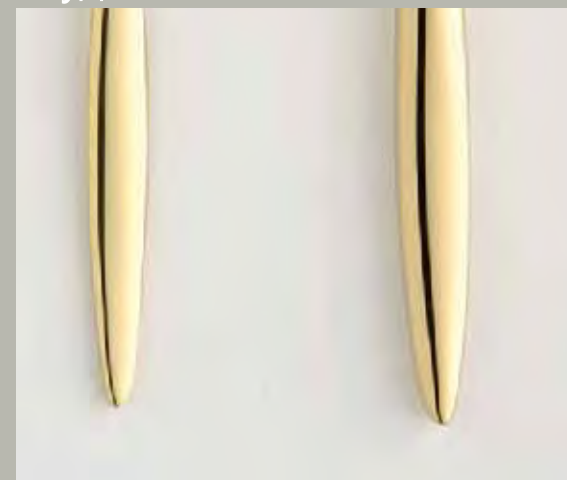

Ποιοι ήμαστε?

Eternum

Ο δικός σας ειδικός
στα μαχαιροπήρουνα
από το 1924.



Η Eternum συστάθηκε το 1924.

Η εταιρία μας εδρεύει στην πόλη Gembloux του Βελγίου όπου βρίσκεται και η βελγική μας μονάδα παραγωγής και η αποθήκη με χωρητικότητα 3.000 παλέτες.

Είμαστε μια 100% θυγατρική εταιρία του νορβηγικού ομίλου K.A Rasmussen, (www.karasmussen.no), μια εταιρία χόλντινγκ που εξειδικεύεται στην παραγωγή και πώληση ευγενών μετάλλων διοχετεύοντας τα σε καταναλωτικές και βιομηχανικές αγορές.

Η Eternum εστιάζει αποκλειστικά σε μαχαιροπήρουνα και αξεσουάρ από ανοξείδωτο ατσάλι για το έτοιμο, στρωμένο τραπέζι και το μπουφέ. Χάρη στην εξειδικευμένη μας τακτική και στην εντατική πολιτική μας όσον αφορά την ανάπτυξη προϊόντων εξελιχθήκαμε σε σημαντικό προμηθευτή μαχαιροπήρουνων σε διεθνές επίπεδο.

Διαθέτουμε δίκτυο διανομών και τοπικών αντιπροσώπων σε 40 χώρες και όλες οι σειρές είναι παραδοτέες από το απόθεμά μας.

Μήνυμα από το διοικητικό συμβούλιο

Αγαπητέ πελάτη,

Το όραμα και η αποστολή της Eternum έχει εσάς ως αφετηρία και το σημαντικότερο μας προϊόν αποτελεί η εξυπηρέτηση πελατών.

Η εξυπηρέτησή μας δεν σημαίνει μόνο αξιοπιστία παράδοσης 98,7%*, αλλά ενισχύεται από την επιπλέον διάσταση που εσείς, ως πελάτης, χρειάζεστε σήμερα περισσότερο από ποτέ:

- Γρήγορη και ευέλικτη ανταπόκριση στις απορίες και τις ανάγκες σας.
- Η ανάπτυξη των κατάλληλων νέων προϊόντων έτσι ώστε να αυξάνεται ο κύκλος εργασιών σας καθώς και η ικανοποίηση των πελατών.
- Αυστηρός έλεγχος λειτουργικών δαπανών της εταιρίας μας για να σας προσφέρουμε ποιότητα σε σωστή τιμή.

Καθημερινά κοπιάζουμε για να υλοποιήσουμε αυτό το όραμα σε όλα τα επίπεδα της επιχείρησης, με αποτέλεσμα να μπορείτε να βασίζεστε διαρκώς στο ζήλο όλης της ομάδας της Eternum!

Είμαστε πάντα στη διάθεσή σας.

Frank De Lombaert
Ο Πληρεξούσιος Διοικητής

Harald Sverdrup
Ο Πρόεδρος του Δ.Σ.

* Μέσος όρος εξυπηρέτησης για το 2009

Το Βέλγιο ως μικρή χώρα στο κέντρο της Ευρώπης αποτελεί κράμα διαφόρων γλωσσών και πολιτισμών, δεχόμενο πολλές επιρροές.

Για αυτό κι εμείς ως Βελγική εταιρία συνεργαζόμαστε κυρίως με σχεδιαστές του Βελγίου, μερικοί από τους οποίους απέκτησαν μεγάλη φήμη σε διεθνές επίπεδο.



Nedda El Asmar,
Appetize Design

<http://www.nedda.be>



Louis de Limburg,
Stirum Design

<http://stirum-design.be>



eternum
signature



Ευέλικτος σχεδιασμός ατόνι



Η Eternum Signature είναι μια συλλογή εξαιρετικής ποιότητας για τα καλά ξενοδοχεία και εστιατόρια

- > Χρησιμοποιείται μόνο ανοξείδωτο ατσάλι 18/10.
- > Η δημιουργία νέων σχεδίων πραγματοποιείται σε συνεργασία με εξωτερικούς συνεργάτες

eternum



Η σειρά Eternum ταιριάζει απόλυτα σε χώρους για ένα απλό δείπνο.

- > Χρησιμοποιείται τόσο το ανοξείδωτο ατσάλι 18/10 όσο και το 18/0.
- > δημιουργία νέων σχεδίων πραγματοποιείται είτε σε συνεργασία με εξωτερικούς συνεργάτες ή από το τμήμα σχεδιασμού της εταιρίας μας.

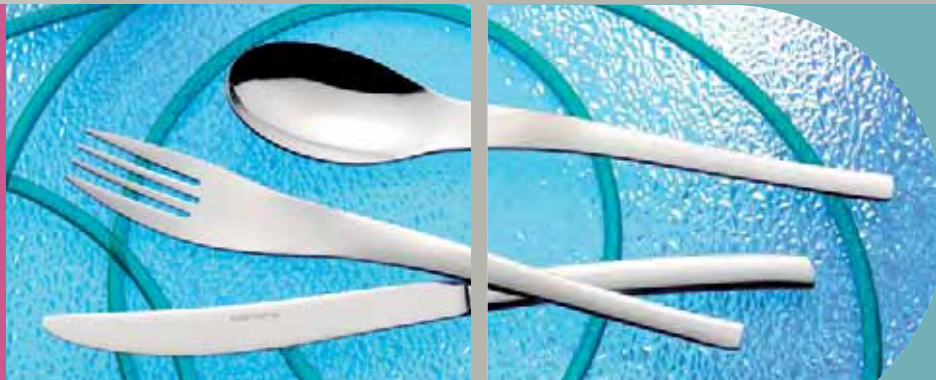

Μπορούμε να δώσουμε προσωπικό χαρακτήρα στις παραγγελίες σας, ώστε να ανταποκρίνονται πλήρως στις ανάγκες σας

Ανάγλυφη χάραξη
Με ή χωρίς νέα στίλβωση



Χάραξη
(Ηλεκτρόλυση)



Εγχάραξη με
διαμάντι

Εγχάραξη με λείζερ



Νέα στίλβωση σε ματ Αμμοβολή



Επαργύρωση

μαχαιροπήρουνα 33 ή 40 μικρόν
επιτραπέζια σκεύη 10 ή 15 μικρόν



Επιχρύσωση

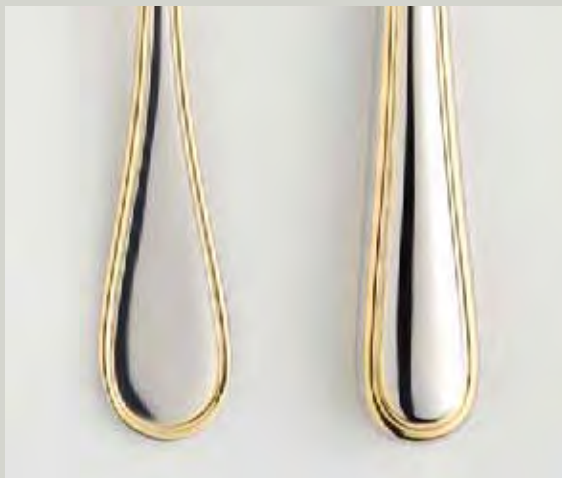

Επικάλυψη PVD

Ανθρακίτης

κατάλληλο για τρόφιμα - αντοχή στα γδαρσίματα - τουλάχιστον 400τεμ/χρώμα



Επικάλυψη PVD

Χρυσός

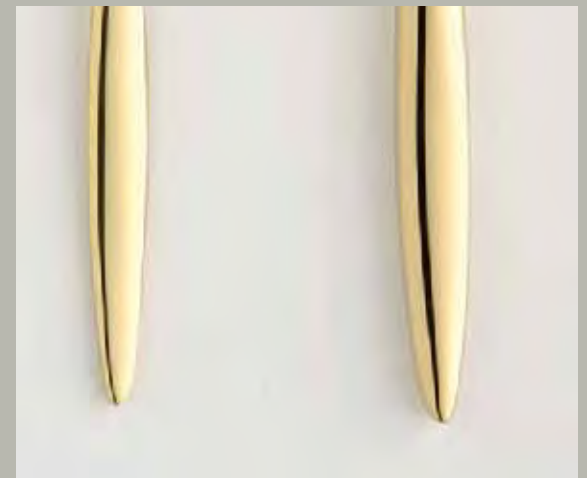

Hotel reference list :



AFRICA		
Lybia	Tripoli	Sheraton
Marocco	Agadir	Hotel Tikida
Mauritius	Bel Ombre	Heritage Golf & Spa
Mauritius	Flic en Flac	Sofitel imperial
Nigeria	Abuja	Hilton
Nigeria	Abuja	Hilton Nicon Noga
Seychelles	Praslin	Lemuria Resort
South Africa	Cape Town	Mount Nelson
South Africa	Johannesburg	Crowne Plaza The Rosebank
South Africa	Magaliesburg	Mount Grace Lodge
Tchad	N'Djamena	Kempinski
Uganda	Luanda	Talatona Convention hotel
AMERICA (CENTRAL + CARIBBEAN ISLANDS)		
Anguilla		Cap Juluca
Anguilla		CuisinArt Resort & Spa
Anguilla		Malliouhana hotel & Spa
Antigua	St John's	Blue Waters
Aruba		Amsterdam Manor Beach Resort
Aruba		Divi Resorts
Saint-Martin		La Samanna Luxury Resort & Spa
Sint-Maarten		Radisson
Sint-Maarten		Westin Dawn Beach Resort & Spa
AMERICA (SOUTH)		
Colombia	Bogota	Sheraton
Colombia	Cali	Sheraton
Suriname		Bergendal Eco & Cultural River
ASIA		
China	Beijing	Grand Millenium
China	Beijing	Shangri-La
China	Beijing	Sofitel
China	Chanksha	Crowne Plaza
China	Chongqing	Holiday Inn
China	Hangzhou	Century Hotel Xiaoshan
China	Sanya	Crown Plaza
China	Sanya	Sanya Resort Intercontinental
China	Shanghai	Crowne Plaza Fudan
China	Shanghai	Four Seasons
China	Shanghai	New Westin
China	Shanghai	Novotel
China	Shenzhen	Crowne Plaza
China	Shenzhen	Four Points Sheraton
China	Shenzhen	Intercontinental
China	Wuhan	Novotel
China	Xiamen	Crowne Plaza
India	Cochin	Le Meridien

india	Goa	Park Hyatt
India	Hyderabad	Meridien Resort Banjara Hills
India	Hyderabad	Minerva Grand
India	Mumbai	Westin
India	Sohna	Westin
Indonesia	Bali	Conrad
Indonesia	Bali	Intercontinental Jimbaran
Japan	Tokyo	Mandarin Oriental
Kazachstan	Astana	Okan Inter-Continental
Maldives	Male	Holiday Inn
Singapore		Marriott
EUROPE (WEST & SOUTH)		
Belgium	Antwerp	Corinthia
Belgium	Antwerp	Hilton
Belgium	Antwerp	Holiday Inn Crowne Plaza
Belgium	Brussels	Hilton
Belgium	Brussels	Hotel Palace Crowne Plaza
Belgium	Brussels	Husa President Park
Belgium	Brussels	Le Plaza
Belgium	Brussels	President WTC
Belgium	Marke	d-hotel
Belgium	Spa	Radisson SAS
Belgium	Zaventem	Crowne Plaza
Cyprus	Aphrodite Hills	Intercontinental
Cyprus	Limassol	Atlantica Group
Cyprus	Limassol	Le Meridien
Cyprus	Paphos	Anassa Hotel
England	Heathrow	Radisson
Finland	Helsinki	Klippan Palace
Finland	Helsinki	Royal Crown
France	Orly	Hilton
France	Paris	Hilton
France	Strasbourg	Hilton
Germany	Cologne	Radisson SAS
Germany	Fleesensee	Robinson Club
Greece	Athens	Athens Grand Hotel
Greece	Athens	Meliá
Greece	Athens (Kifisia)	Twenty One
Greece	Corfu	Corfu Imperial
Greece	Kos	Porto Bello Royal
Greece	Sithonia	Porto Carras Resort
Ireland	Ashbourne	Marriott
Ireland	Cork	Cork Airport Hotel
Ireland	Galway	Radisson SAS
Malta	St Julians	Inter-Continental
Portugal	Acores	Hotel Avenida
Portugal	Acores	Hotel Do Canal

Portugal	Acores	Hotel Marina Atlantico
Portugal	Acores	Terceira Mar Hotel
Portugal	Lisbon	Acores Lisboa
Portugal	Madeira	Royal Savoy
Spain	Madrid	Inter-Continental
Spain	Madrid (Barajas)	Hilton
Switzerland	Zurich	Park Inn
Turkey	Istanbul	Inter-Continental
Turkey	Konya	Hilton
Turkey	Nobilis	Robinson Club
EUROPE (EAST)		
Bulgaria	Sofia	Radisson SAS
Czech Republic	Prague	Savoy
Hungary	Budapest	Holiday Beach
Hungary	Budapest	Polus Palace
Lithuania	Klaipeda	Radisson SAS
Poland	Warsaw	Radisson SAS
Poland	Wroclaw	Radisson SAS
Rumania	Bucharest	Hilton
Russia	Ekatارينenburg	Park Inn
Russia	Kiev	Tivoli
Slovakia	Bratislava	Radisson SAS
MIDDLE EAST		
Bahrein	Riffa Views	The Royal Golf Club
Oman	Muscat	Radisson SAS
Qatar	Doha	Mercure Grand Hotel
Saoudi Arabia	Makkah	Sofitel
Syria	Damascus	Sheraton
UAE	Abu Dhabi	Sheraton
UAE	Al Ain	Hilton
UAE	Dubai	Dubai Creek Golf & Yacht Club
UAE	Dubai	Emirates Hotel
UAE	Dubai	Grand Hyatt
UAE	Dubai	Kempinski Mall of the Emirates
UAE	Dubai	Rotana hotels
UAE	Dubai	Royal Meridien
UAE	Dubai	Taj Palace Hotel
UAE	Fujeirah	Hilton
UAE	Ras Al Khaimah	Al Hamra Fort Hotel
UAE	Ras Al Khaimah	Hilton
UAE	Ras Al Khaimah	Rak Hotel
OCEANIA		
Australia	Brisbane	Grand Chancellor Hotel
Australia	Melbourne	Hilton Convention Center
Australia	Melbourne	Sofitel



















X15

1860 - forged - 10,0 mm - 18-10

Stirum Design

Article		Description	Length (mm)	Gage (mm)	EAN 13: 5413521+	Master (Pcs)
1860-1		table fork	218	10	860018	120
1860-2		table spoon	215	10	860025	120
1860-5		table knife mono	242	137 gr	860056	120
1860-14		dessert fork	193	8,5	860148	120
1860-15		dessert spoon	191	8,5	860155	120
1860-6		dessert knife mono	216	93 gr	860063	120
1860-3		tea spoon	143	6,5	860032	300
1860-26		mocca spoon	110	5,5	860261	300
1860-4		cake fork	144	6,5	860049	300
1860-16		fish fork	192	8,5	860162	120
1860-17		fish knife	206	8,5	860179	120
1860-33		soup spoon	189	8,5	860339	120
1860-40		fruit/butter knife	162	46 gr	860407	240
1860-25		cocktail spoon	213	9,5	860254	120



*Louis de Limburg,
Stirum Design*

<http://stirum-design.be>

















Appetize

3030 - forged - 2,5 mm - 18-10

Nedda El Asmar

Article		Description	Length (mm)	Gage (mm)	EAN 13: 5413521+	Master (Pcs)
3030-1		table fork	216	2,5	30015	120
3030-2		table spoon	215	2,5	30022	120
3030-5		table knife mono	238	91 gr	30053	120
3030-14		dessert fork	184	2,5	30145	120
3030-15		dessert spoon	184	2,5	30152	120
3030-6		dessert knife mono	200	63 gr	30060	120
3030-3		tea spoon	141	2	30039	600
3030-26		mocca spoon	105	1,8	30268	600
3030-17		fish knife	209	2,5	30176	120
3030-40		fruit/butter knife	140	51 gr	30404	240
3030-25		cocktail spoon	199	2,5	30251	120
3030-41		combi-stick	228	2,5	30411	300
3030-10		salad server		-	30107	1
3030-34		zakouski spoon 18-0	99	2,0	030343	300
3030-39		zakouski fork 18-0	100	2,5	030398	600



Designer of
Belgium
the year 2007



Nedda El Asmar,
Appetize Design

<http://www.nedda.be>

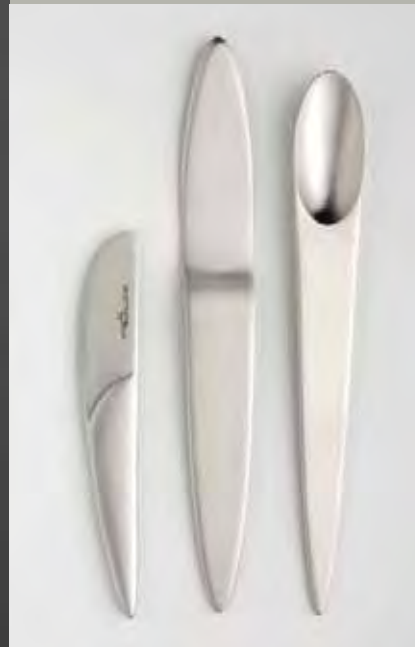

Atlantis

3010 - 4,0 mm - 18-10

Stirum Design

table knife mono

3010-5



Article	Description	Length (mm)	Gage (mm)	EAN 13: 5413521+	Master (Pcs)
3010-1	table fork	212	4	310018	300
3010-2	table spoon	211	4	310025	300
3010-5	table knife mono	234	111 gr	310056	120
3010-5V	table knife mono "vertical"	233	100 gr	310599	120
3010-51	table knife HH	233	-	310513	120
3010-14	dessert fork	187	3	310148	300
3010-15	dessert spoon	185	3	310155	300
3010-6	dessert knife mono	211	78 gr	310063	120
3010-6V	dessert knife mono "vertical"	212	78 gr	310568	120
3010-61	dessert knife HH	213	-	310612	120
3010-3	tea spoon	145	2,5	310032	600
3010-26	mocca spoon	114	2,5	310261	600
3010-4	cake fork	145	2,5	310049	600
3010-16	fish fork	186	3	310162	300
3010-17	fish knife	199	3	310179	300
3010-33	soup spoon	173	3	310339	300
3010-40	fruit/butter knife	163	39 gr	310407	300
3010-45	steak knife	234	108 gr	310452	120
3010-25	cocktail spoon	260	3	310254	300
3010-32	tasting spoon	181	3	310322	300
3010-7	soup ladle	296	3	310070	1
3010-8	cake server	256	4	310087	1
3010-10	salad server	295	4	310100	1
3010-11	gravy ladle	186	4	310117	1
3010-12	servng spoon	224	4	310124	1

Alaska

2080 - 3,5 mm - 18-10

Stirum Design



Article	Description	Length (mm)	Gage (mm)	EAN 13: 5413521+	Master (Pcs)
2080-1	table fork	203	3,5	208018	300
2080-2	table spoon	205	3,5	208025	300
2080-5	table knife mono	226	68 gr	208056	240
2080-14	dessert fork	181	3	208148	300
2080-15	dessert spoon	181	3	208155	300
2080-6	dessert knife mono	203	50 gr	208063	300
2080-3	tea spoon	140	2,5	208032	600
2080-26	mocca spoon	118	2,2	208261	600
2080-4	cake fork	143	2,5	208049	600
2080-16	fish fork	187	3	208162	300
2080-17	fish knife	192	3	208179	300
2080-45	steak knife	225	68 gr	208452	240
2080-25	cocktail spoon	200	3,2	208254	300
2080-35	spaghetti fork	220	-	208353	300
2080-36	spaghetti spoon	213	-	208360	300
2080-7	soup ladle	165	3,5	208070	1
2080-8	cake server	259	3,5	208087	1
2080-10	salad server	234	3,5	208100	1
2080-11	gravy ladle	173	3,5	208117	1
2080-12	serving spoon	215	3,5	208124	1





















Spaghetti cutlery



Oslo

1930 - 4,0 mm - 18-10

Stirum Design



















Article	Description	Length (mm)	Gage (mm)	EAN 13: 5413521+	Master (Pcs)
1930-1	 table fork	210	4	930018	300
1930-2	 table spoon	209	4	930025	300
1930-5	 table knife mono	235	113 gr	930056	120
1930-14	 dessert fork	188	2,8	930148	300
1930-15	 dessert spoon	188	2,8	930155	300
1930-6	 dessert knife mono	215	86 gr	930063	120
1930-3	 tea spoon	145	2,5	930032	600
1930-26	 mocca spoon	116	2,5	930261	600
1930-4	 cake fork	142	2,5	930049	600
1930-16	 fish fork	189	2,8	930162	300
1930-17	 fish knife	210	2,8	930179	300
1930-33	 soup spoon	184	2,8	930339	300
1930-40	 fruit/butter knife	160	45 gr	930407	300
1930-45	 steak knife	242	112 gr	930452	120
1930-7	 soup ladle	276	3	930070	1
1930-8	 cake server	244	3	930087	1
1930-10	 salad server	301	3	930100	1
1930-11	 gravy ladle	168	2,8	930117	1
1930-12	 serving spoon	250	3	930124	1



Adagio

2990 - 4,0 mm - 18-10

Stirum Design





















Article	Description	Length (mm)	Gage (mm)	EAN 13: 5413521+	Master (Pcs)
2090-1	 table fork	204	4	209015	300
2090-2	 table spoon	205	4	209022	300
2090-5	 table knife mono	224	87 gr	209053	120
2090-51	 table knife HH	224	-	209510	240
2090-14	 dessert fork	183	3	209145	300
2090-15	 dessert spoon	180	3	209152	300
2090-6	 dessert knife mono	202	60 gr	209060	120
2090-61	 dessert knife HH	202	-	209619	240
2090-3	 tea spoon	137	2,5	209039	600
2090-26	 mocca spoon	116	2,5	209268	600
2090-4	 cake fork	140	2,5	209046	600
2090-16	 fish fork	189	3	209169	300
2090-17	 fish knife	201	3	209176	300
2090-40	 fruit/butter knife	162	40 gr	209404	300
2090-7	 soup ladle	281	4	209077	1
2090-8	 cake server	242	4	209084	1
2090-10	 salad server	235	4	209107	1
2090-11	 gravy ladle	174	3,5	209114	1
2090-12	 serving spoon	251	4	209121	1



Alinea

3020 - 4,0 mm - 18-10

Stirum Design

Article	Description	Length (mm)	Gage (mm)	EAN 13: 5413521+	Master (Pcs)
3020-1	 table fork	208	4	320017	300
3020-2	 table spoon	208	4	320024	300
3020-5	 table knife mono	240	117 gr	320055	120
3020-14	 dessert fork	193	3	320147	300
3020-15	 dessert spoon	191	3	320154	300
3020-6	 dessert knife mono	218	85 gr	320062	120
3020-3	 tea spoon	143	2,5	320031	600
3020-26	 mocca spoon	114	2,2	320260	600
3020-4	 cake fork	149	2,5	320048	600
3020-16	 fish fork	194	3	320161	300
3020-17	 fish knife	208	3	320178	300
3020-33	 soup spoon	184	3	320338	300
3020-40	 fruit/butter knife	159	42 gr	320406	300
3020-45	 steak knife	245	121 gr	320451	120
3020-7	 soup ladle	280	4	320079	1
3020-8	 cake server	258	4	320086	1
3020-10	 salad server	289	4	320109	1
3020-11	 gravy ladle	170	3,5	320116	1
3020-12	 serving spoon	248	4	320123	1
3020-21	 serving fork	248	4	320215	1



Arcade

1620 - 3,5 mm - 18-10

Stirum Design

Article	Description	Length (mm)	Gage (mm)	EAN 13: 5413521+	Master (Pcs)
1620-1	table fork	208	3,5	620018	300
1620-2	table spoon	208	3,6	620025	300
1620-5	table knife mono	238	106 gr	620056	120
1620-51	table knife HH	240	-	620513	240
1620-14	dessert fork	186	2,8	620148	300
1620-15	dessert spoon	185	2,8	620155	300
1620-6	dessert knife mono	214	79 gr	620063	120
1620-61	dessert knife HH	215	-	620612	240
1620-3	tea spoon	142	2,5	620032	600
1620-26	mocca spoon	117	2,5	620261	600
1620-4	cake fork	144	2,3	620049	600
1620-16	fish fork	180	2,8	620162	300
1620-17	fish knife	201	2,8	620179	300
1620-33	soup spoon	173	2,8	620339	300
1620-40	fruit/butter knife	160	36 gr	620407	300
1620-45	steak knife	238	106 gr	620452	120

The Arcade pattern can be combined with the patterns Ascot (page 69) and Beaubourg (page 70), offering you 70 items to compose any table setting!























Ascot

3050 - 3,0 mm - 18-10

Stirum Design

Article	Description	Length (mm)	Gage (mm)	EAN 13: 5413521+	Master (Pcs)
3050-1	 table fork	207	3	350014	300
3050-2	 table spoon	207	3	350021	300
3050-5	 table knife mono	231	110 gr	350052	120
3050-14	 dessert fork	183	2,5	350144	300
3050-15	 dessert spoon	184	2,5	350151	300
3050-6	 dessert knife mono	208	77 gr	350069	120
3050-3	 tea spoon	114	2,2	350038	600
3050-26	 mocca spoon	115	2	350267	600
3050-4	 cake fork	145	2	350045	600
3050-16	 fish fork	178	2,5	350168	300
3050-17	 fish knife	197	2,5	350175	300
3050-33	 soup spoon	170	2,5	350335	300
3050-40	 fruit/butter knife	158	38 gr	350403	300
3050-45	 steak knife	236	114 gr	350458	120
3050-7	 soup ladle	302	3	350076	1
3050-8	 cake server	231	2,5	350083	1
3050-10	 salad server	286	3	350106	1
3050-11	 gravy ladle	169	2,5	350113	1
3050-12	 serving spoon	245	3	350120	1

Beaubourg

1920 - 3,0 mm - 18-10

























Article	Description	Length (mm)	Gage (mm)	EAN 13: 5413521+	Master (Pcs)
1920-1	table fork	198	3	920019	300
1920-2	table spoon	199	3	920026	300
1920-5	table knife mono	210	98 gr	920057	120
1920-51	table knife HH	211	-	920514	120
1920-14	dessert fork	178	2,5	920149	300
1920-15	dessert spoon	180	2,5	920156	300
1920-6	dessert knife mono	188	69 gr	920064	240
1920-61	dessert knife HH	188	-	920613	120
1920-3	tea spoon	144	2,2	920033	600
1920-26	mocca spoon	117	2	920262	600
1920-4	cake fork	148	2	920040	600
1920-16	fish fork	179	2,5	920163	300
1920-17	fish knife	202	2,5	920170	300
1920-33	soup spoon	175	2,5	920330	300
1920-40	fruit/butter knife	155	48 gr	920408	300
1920-25	cocktail spoon	193	2,5	920255	300
1920-18	icecream spoon	143	2	920187	600
1920-19	oyster fork	144	2,2	920194	600
1920-20	snail fork	145	2	920200	600
1920-32	tasting spoon	197	2,5	920323	300
1920-34	zakouski spoon	118	2,5	920347	1
1920-7	soup ladle	310	3	920071	1
1920-8	cake server	247	3	920088	1
1920-9	chips server	254	3	920095	1
1920-10	salad server	204	3	920101	1
1920-11	gravy ladle	177	3	920118	1
1920-12	serving spoon	224	3	920125	1
1920-21	serving fork	211	3	920217	1
1920-23	carving fork	255	-	920231	1
1920-24	carving knife	285	-	920248	1
1920-27B	butter knife mono	164	-	920279	1
1920-27	butter knife HH	216	-	920279	1
1920-28	cheese knife HH	210	-	920286	1
1920-29	cake knife HH	248	-	920293	1
1920-30	fish serving fork	244	-	920309	1
1920-31	fish serving knife	272	-	920316	1

Nordic

1910 - 3,0 mm - 18-10















Article	Description	Length (mm)	Gage (mm)	EAN 13: 5413521+	Master (Pcs)
1910-1	 table fork	196	3	910010	300
1910-2	 table spoon	196	3	910027	300
1910-5	 table knife mono	212	77 gr	910058	240
1910-14	 dessert fork	177	2,5	910140	300
1910-15	 dessert spoon	176	2,5	910157	300
1910-6	 dessert knife mono	196	60 gr	910065	240
1910-3	 tea spoon	138	2	910034	600
1910-26	 mocca spoon	138	2	910263	600
1910-4	 cake fork	141	2	910041	600
1910-16	 fish fork	173	2,5	910164	300
1910-17	 fish knife	195	2,5	910171	300
1910-25	 cocktail spoon	201	3	910256	300
1910-18	 icecream spoon	138	2,2	910188	600
1910-19	 oyster fork	134	2	910195	600
1910-20	 snail fork	141	2	910201	600
1910-7	 soup ladle	314	3	910072	1
1910-8	 cake server	248	3	910089	1
1910-9	 chips server	250	3	910096	1
1910-10	 salad server	203	3	910102	1
1910-11	 gravy ladle	178	3	910119	1
1910-12	 serving spoon	226	3	910126	1
1910-21	 serving fork	214	3	910218	1
1910-27B	 butter knife mono	179	2,2	910270	1



Atrium

1870 - forged - 7,0 mm - 18-10

Stirum Design

Article		Description	Length (mm)	Gage (mm)	EAN 13: 5413521+	Master (Pcs)
1870-1		table fork	209	7	870017	120
1870-2		table spoon	210	7	870024	120
1870-5		table knife mono	233	136 gr	870055	120
1870-14		dessert fork	190	6	870147	120
1870-15		dessert spoon	190	6	870154	120
1870-6		dessert knife mono	213	96 gr	870062	120
1870-3		tea spoon	145	4	870031	300
1870-26		mocca spoon	110	3	870260	300
1870-4		cake fork	145	4	870048	300
1870-16		fish fork	190	6	870161	120
1870-17		fish knife	206	6	870178	120
1870-33		soup spoon	190	6	870338	120
1870-40		fruit/butter knife	161	42 gr	870406	240

Byblos

1840 - 3,8 mm - 18-10



Article	Description	Length (mm)	Gage (mm)	EAN 13: 5413521+	Master (Pcs)
1840-1	table fork	209	3,8	840010	300
1840-2	table spoon	207	3,8	840027	300
1840-51	table knife HH	239	-	840515	240
1840-14	dessert fork	183	3,2	840140	300
1840-15	dessert spoon	182	3,2	840157	300
1840-61	dessert knife HH	214	-	840614	180
1840-3	tea spoon	143	3	840034	600
1840-26	mocca spoon	116	2,8	840263	600
1840-4	cake fork	146	2,8	840041	600
1840-16	fish fork	178	3,2	840164	300
1840-17	fish knife	197	3,2	840171	300
1840-33	soup spoon	172	3,2	840331	300
1840-25	cocktail spoon	192	3,2	840256	300
1840-18	icecream spoon	138	2,7	840188	600
1840-19	oyster fork	136	2,7	840195	600
1840-20	snail fork	143	2,5	840201	600
1840-32	tasting spoon	180	3,2	840324	300
1840-7	soup ladle	313	3,8	840072	1
1840-8	cake server	247	3,8	840089	1
1840-9	chips server	251	3,8	840096	1
1840-10	salad server	210	3,8	840102	1
1840-11	gravy ladle	180	3,8	840119	1
1840-12	serving spoon	223	-	840126	1
1840-21	serving fork	215	3,8	840218	1
1840-23	carving fork	246	-	840232	1
1840-24	carving knife	287	-	840249	1
1840-27B	butter knife mono	158	2,5	840270	1
1840-27	butter knife HH	204	-	840270	1
1840-28	cheese knife HH	200	-	840287	1
1840-29	cake knife HH	250	-	840294	1
1840-30	fish serving fork	233	-	840300	1
1840-31	fish serving knife	267	-	840317	1

Baguette

1610 - 3,5 mm - 18-10



Article	Description	Length (mm)	Gage (mm)	EAN 13: 5413521+	Master (Pcs)
1610-1	table fork	208	3,5	610019	300
1610-2	table spoon	205	3,5	610026	300
2610-5	table knife mono	238	111 gr	261051	240
1610-51	table knife HH	250	-	610514	240
1610-14	dessert fork	184	3	610149	300
1610-15	dessert spoon	187	3	610156	300
2610-6	dessert knife mono	212	84 gr	261068	240
1610-61	dessert knife HH	222	-	610613	240
1610-3	tea spoon	137	2,5	610033	600
1610-26	mocca spoon	111	2	610262	600
1610-4	cake fork	152	2,5	610040	600
1610-16	fish fork	181	3	610163	300
1610-17	fish knife	200	3	610170	300
1610-33	soup spoon	163	2,5	610330	300
1610-40	fruit/butter knife	165	43 gr	610408	300
1610-45	steak knife	236	-	610453	240
1610-25	cocktail spoon	201	3	610255	300
1610-32	tasting spoon	182	2,5	610323	300
1610-7	soup ladle	284	3,5	610071	1
1610-8	cake server	249	3,5	610088	1
1610-10	salad server	200	3,5	610101	1
1610-11	gravy ladle	168	3,5	610118	1
1610-12	serving spoon	251	3,5	610125	1

Anser 1670 - 3,0mm - 18-10



Article	Description	Length (mm)	Gage (mm)	EAN 13: 5413521+	Master (Pcs)
1670-1	table fork	208	3	670013	300
1670-2	table spoon	207	3	670020	300
1670-5	table knife mono	236	113 gr	670051	120
1670-51	table knife HH	237	-	670518	120
1670-14	dessert fork	183	2,5	670143	300
1670-15	dessert spoon	183	2,5	670150	300
1670-6	dessert knife mono	213	95 gr	670068	120
1670-61	dessert knife HH	215	-	670617	120
1670-3	tea spoon	143	2,2	670037	600
1670-26	mocca spoon	118	2,2	670266	600
1670-4	cake fork	145	2,2	670044	600
1670-16	fish fork	173	2,5	670167	300
1670-17	fish knife	196	2,5	670174	300
1670-33	soup spoon	173	2,5	670334	300
1670-40	fruit/butter knife	160	48 gr	670402	300
1670-45	steak knife	235	113 gr	670457	120
1670-25	cocktail spoon	192	2,5	670259	300
1670-18	icecream spoon	131	2	670181	600
1670-19	oyster fork	136	2,2	670198	600
1670-20	snail fork	142	2	670204	600
1670-32	tasting spoon	182	2,5	670327	300
1670-7	soup ladle	312	2,5	670075	1
1670-8	cake server	257	2,5	670082	1
1670-9	chips server	256	2,5	670099	1
1670-10	salad server	212	2,5	670105	1
1670-11	gravy ladle	182	2,5	670112	1
1670-12	serving spoon	225	2,5	670129	1
1670-21	serving fork	214	2,2	670211	1
1670-23	carving fork	245	-	670235	1
1670-24	carving knife	290	-	670242	1
1670-27	butter knife HH	207	-	670273	1
1670-28	cheese knife HH	200	-	670280	1
1670-29	cake knife HH	249	-	670297	1
1670-30	fish serving fork	235	-	670303	1
1670-31	fish serving knife	265	-	670310	1

Louvres 1650 - 3,0 mm - 18-10



Article	Description	Length (mm)	Gage (mm)	EAN 13: 5413521+	Master (Pcs)
1650-1	table fork	207	3	650015	300
1650-2	table spoon	206	3	650022	300
1650-5	table knife mono	236	112 gr	650053	240
1650-51	table knife HH	236	-	650510	240
1650-14	dessert fork	183	2,5	650145	300
1650-15	dessert spoon	183	2,5	650152	300
1650-6	dessert knife mono	213	94 gr	650060	240
1650-61	dessert knife HH	212	-	650619	240
1650-3	tea spoon	145	2,5	650039	600
1650-26	mocca spoon	116	2,5	650268	600
1650-4	cake fork	142	2	650046	600
1650-16	fish fork	181	2,5	650169	300
1650-17	fish knife	197	2,5	650176	300
1650-33	soup spoon	166	2,5	650336	300
1650-25	cocktail spoon	193	2,5	650251	300
1650-18	icecream spoon	137	2	650183	600
1650-19	oyster fork	134	2	650190	600
1650-20	snail fork	142	2	650206	600
1650-32	tasting spoon	187	2,5	650329	300
1650-7	soup ladle	322	3	650077	1
1650-8	cake server	259	3	650084	1
1650-9	chips server	254	3	650091	1
1650-10	salad server	212	3	650107	1
1650-11	gravy ladle	184	3	650114	1
1650-12	serving spoon	225	3	650121	1
1650-21	serving fork	214	3	650213	1
1650-23	carving fork	248	-	650237	1
1650-24	carving knife	290	-	650244	1
1650-27B	butter knife mono	162	2,5	650275	1
1650-27	butter knife HH	212	-	650275	1
1650-28	cheese knife HH	212	-	650282	1
1650-29	cake knife HH	234	-	650299	1
1650-30	fish serving fork	240	-	650305	1
1650-31	fish serving knife	271	-	650312	1

Contour

1800 - 3,0 mm - 18-10



Article	Description	Length (mm)	Gage (mm)	EAN 13: 5413521+	Master (Pcs)
1800-1	table fork	207	3	800014	300
1800-2	table spoon	209	3	800021	300
1800-5	table knife mono	244	120 gr	800052	120
1800-51	table knife HH	244	-	800519	120
1800-14	dessert fork	183	2,5	800144	300
1800-15	dessert spoon	183	2,5	800151	300
1800-6	dessert knife mono	215	84 gr	800069	240
1800-61	dessert knife HH	212	-	800618	240
1800-3	tea spoon	143	2,5	800038	600
1800-26	mocca spoon	116	2,2	800267	600
1800-4	cake fork	144	2,2	800045	600
1800-16	fish fork	181	2,5	800168	300
1800-17	fish knife	198	2,5	800175	300
1800-40	fruit/butter knife	160	45 gr	800403	300
1800-25	cocktail spoon	193	2,5	800250	300
1800-18	icecream spoon	138	2,2	800182	600
1800-19	oyster fork	135	2,2	800199	600
1800-20	snail fork	143	2,2	800205	600
1800-7	soup ladle	327	3	800076	1
1800-8	cake server	255	3	800083	1
1800-9	chips server	254	3	800090	1
1800-10	salad server	210	3	800106	1
1800-11	gravy ladle	180	3	800113	1
1800-12	serving spoon	238	3	800120	1
1800-21	serving fork	214	3	800212	1
1800-23	carving fork	248	-	800236	1
1800-24	carving knife	290	-	800243	1
1800-27	butter knife HH	206	-	800274	1
1800-28	cheese knife HH	205	-	800281	1
1800-29	cake knife HH	250	-	800298	1
1800-30	fish serving fork	235	-	800304	1
1800-31	fish serving knife	265	-	800311	1

Châtelet

1680 - 3,0 mm - 18-10























Article	Description	Length (mm)	Gage (mm)	EAN 13: 5413521+	Master (Pcs)
1680-1	table fork	206	3	680012	300
1680-2	table spoon	207	3	680029	300
1680-51	table knife HH	238	-	680517	120
1680-14	dessert fork	183	2,5	680142	300
1680-15	dessert spoon	182	2,5	680159	300
1680-61	dessert knife HH	219	-	680616	180
1680-3	tea spoon	144	2,2	680036	600
1680-26	mocca spoon	117	2,1	680265	600
1680-4	cake fork	145	2,2	680043	600
1680-16	fish fork	175	2,5	680166	300
1680-17	fish knife	195	2,5	680173	300
1680-40	fruit/butter knife	160	50 gr	680401	240
1680-25	cocktail spoon	193	2,5	680258	300
1680-18	icecream spoon	138	2,2	680180	600
1680-19	oyster fork	134	2,2	680197	600
1680-20	snail fork	142	2,2	680203	600
1680-32	tasting spoon	183	2,5	680326	300
1680-7	soup ladle	312	3	680074	1
1680-8	cake server	257	3	680081	1
1680-9	chips server	256	3	680098	1
1680-10	salad server	212	3	680104	1
1680-11	gravy ladle	182	3	680111	1
1680-12	serving spoon	237	3	680128	1
1680-21	serving fork	214	3	680210	1
1680-23	carving fork	240	-	680234	1
1680-24	carving knife	285	-	680241	1
1680-27	butter knife HH	205	-	680272	1
1680-28	cheese knife HH	200	-	680289	1
1680-29	cake knife HH	245	-	680296	1
1680-30	fish serving fork	235	-	680302	1
1680-31	fish serving knife	265	-	680319	1

Ruban

1640 - 3,0 mm - 18-10



Article		Description	Length (mm)	Gage (mm)	EAN 13: 5413521+	Master (Pcs)
1640-1		table fork	202	3	640016	300
1640-2		table spoon	206	2,5	640023	300
1640-5		table knife mono	245	124 gr	640054	120
1640-51		table knife HH	246	-	640511	240
1640-14		dessert fork	182	2,5	640146	300
1640-15		dessert spoon	182	2,5	640153	300
1640-6		dessert knife mono	221	95 gr	640061	240
1640-61		dessert knife HH	208	-	640610	300
1640-3		tea spoon	143	2,5	640030	600
1640-26		mocca spoon	117	2,2	640269	600
1640-4		cake fork	145	2,2	640047	600
1640-16		fish fork	175	2,5	640160	300
1640-17		fish knife	194	2,5	640177	300
1640-33		soup spoon	173	2,5	640337	300
1640-25		cocktail spoon	192	2,5	640252	300
1640-7		soup ladle	312	2,5	640078	1
1640-8		cake server	257	2,5	640085	1
1640-9		chips server	256	2,5	640092	1
1640-10		salad server	212	2,5	640108	1
1640-11		gravy ladle	182	2,5	640115	1
1640-12		serving spoon	237	2,5	640122	1



Eventail

1630 - 2,5 mm - 18-10

Article	Description	Length (mm)	Gage (mm)	EAN 13: 5413521+	Master (Pcs)
1630-1	table fork	199	2,5	630017	300
1630-2	table spoon	198	2,6	630024	300
1630-5	table knife mono	222	94 gr	630055	240
1630-14	dessert fork	185	2,5	630147	300
1630-15	dessert spoon	184	2,5	630154	300
1630-6	dessert knife	212	89 gr	630062	300
1630-3	tea spoon	135	2,2	630031	600
1630-26	mocca spoon	108	2,2	630260	600
1630-4	cake fork		-	630048	600
1630-16	fish fork	180	2,5	630161	300
1630-17	fish knife	200	2,5	630178	300
1630-33	soup spoon	175	2,5	630338	300
1630-40	fruit/butter knife	159	44 gr	630406	300
1630-25	cocktail spoon	193	2,5	630253	300
1630-18	icecream spoon	137	2,2	630185	600
1630-19	oyster fork	134	2,2	630192	600
1630-20	snail fork	141	2,2	630208	600
1630-32	tasting spoon	197	2,5	630321	300
1630-7	soup ladle	306	2,5	630079	1
1630-8	cake server	244	2,5	630086	1
1630-9	chips server	250	2,5	630093	1
1630-10	salad server	201	2,5	630109	1
1630-11	gravy ladle	178	2,5	630116	1
1630-12	serving spoon	217	2,5	630123	1
1630-21	serving fork	212	2,5	630215	1
1630-30	fish serving fork	217	2,5	630307	1
1630-31	fish serving knife	261	2,5	630314	1

Milano

969 - 3,0 mm - 18-10



Article	Description	Length (mm)	Gage (mm)	EAN 13: 5413521+	Master (Pcs)
969-1	table fork	199	3	969018	300
969-2	table spoon	196	3	969025	300
969-5	table knife mono	218	60 gr	969056	240
969-14	dessert fork	175	2	969148	300
969-15	dessert spoon	177	2,5	969155	300
969-6	dessert knife mono	199	49 gr	969063	240
969-3	tea spoon	142	1,8	969032	600
969-26	mocca spoon	112	1,5	969261	600
969-4	cake fork	148	1,8	969049	600
969-16	fish fork	186	2,5	969162	300
969-17	fish knife	200	2,5	969179	300
969-7	soup ladle	300	2,8	969070	1
969-8	cake server	239	2,5	969087	1
969-9	chips server	225	2,5	969094	1
969-10	salad server	197	2,5	969100	1
969-11	gravy ladle	170	2,5	969117	1
969-12	serving spoon	237	2,5	969124	1

Sonate

977 - 3,0 mm - 18-10

Stirum Design



















Article	Description	Length (mm)	Gage (mm)	EAN 13: 5413521+	Master (Pcs)
977-1	table fork	199	3	977013	300
977-2	table spoon	198	3	977020	300
977-5	table knife mono	219	76 gr	977051	300
977-14	dessert fork	181	2,2	977143	300
977-15	dessert spoon	175	2,2	977150	300
977-6	dessert knife mono	191	56 gr	977068	300
977-3	tea spoon	143	2	977037	600
977-26	mocca spoon	114	1,8	977266	600
977-4	cake fork	149	2	977044	600
977-16	fish fork	180	2,2	977167	300
977-17	fish knife	206	2,2	977174	300
977-33	soup spoon	176	1,8	977334	300
977-45	steak knife	228	82 gr	977457	120
977-7	soup ladle	260	2,8	977075	1
977-8	cake server	255	2,8	977082	1
977-10	salad server	225	2,8	977105	1
977-11	gravy ladle	170	2,8	977112	1
977-12	serving spoon	243	2,8	977129	1

Galaxy

1720 - 3,0 mm - 18-10

Stirum Design



















Article	Description	Length (mm)	Gage (mm)	EAN 13: 5413521+	Master (Pcs)
1720-1	 table fork	208	3	172012	300
1720-2	 table spoon	207	3	172029	300
1720-5	 table knife mono	228	75 gr	172050	240
1720-14	 dessert fork	190	2,5	172142	300
1720-15	 dessert spoon	188	2,5	172159	300
1720-6	 dessert knife mono	203	-	172067	1
1720-3	 tea spoon	145	2	172036	600
1720-26	 mocca spoon	114	1,8	172265	600
1720-4	 cake fork	148	2	172043	600
1720-16	 fish fork	190	2,5	172166	300
1720-17	 fish knife	208	2,5	172173	300
1720-7	 soup ladle	267	3	172074	1
1720-8	 cake server	255	2,8	172081	1
1720-10	 salad server	232	3	172104	1
1720-11	 gravy ladle	160	2,8	172111	1
1720-12	 serving spoon	248	2,8	172128	1

Napoli

1740- 3,0 mm - 18-10



Article		Description	Length (mm)	Gage (mm)	EAN 13: 5413521+	Master (Pcs)
1740-1		table fork	201	3	174016	300
1740-2		table spoon	204	3	174023	300
1740-5		table knife mono	221	75 gr	174054	240
1740-14		dessert fork	189	2,5	174146	300
1740-15		dessert spoon	188	2,5	174153	300
1740-6		dessert knife mono	205	62 gr	174061	300
1740-3		tea spoon	136	2	174030	600
1740-26		mocca spoon	113	2	174269	600
1740-4		cake fork	145	2	174047	600
1740-16		fish fork	200	2,5	174160	300
1740-17		fish knife	209	2,5	174177	300
1740-7		soup ladle	297	3	174078	1
1740-8		cake server	257	3	174085	1
1740-10		salad server	220	3	174108	1
1740-11		gravy ladle	180	3	174115	1
1740-12		serving spoon	220	3	174122	1

Baguette LM

2610 - 2,5 mm - 18-10



Article	Description	Length (mm)	Gage (mm)	EAN 13: 5413521+	Master (Pcs)
2610-1	table fork	208	2,5	261013	300
2610-2	table spoon	208	2,5	261020	300
2610-5	table knife mono	238	111 gr	261051	240
2610-14	dessert fork	181	2	261143	300
2610-15	dessert spoon	180	2	261150	300
2610-6	dessert knife mono	212	84 gr	261068	240
2610-3	tea spoon	135	2	261037	600
2610-26	mocca spoon	112	1,8	261266	600
2610-4	cake fork	143	2	261044	600
2610-16	fish fork	174	2	261167	300
2610-17	fish knife	195	2	261174	300
2610-33	soup spoon	175	2	261334	300

Rivoli

1921 - 2,5 mm - 18-10



Article	Description	Length (mm)	Gage (mm)	EAN 13: 5413521+	Master (Pcs)
1921-1	table fork	196	2,5	921016	300
1921-2	table spoon	195	2,5	921023	300
1921-5	table knife mono	210	98 gr	921054	120
1921-14	dessert fork	179	2	921146	300
1921-15	dessert spoon	181	2	921153	300
1921-6	dessert knife mono	188	69 gr	921061	240
1921-3	tea spoon	144	2	921030	600
1921-26	mocca spoon	118	1,8	921269	600
1921-4	cake fork	149	2	921047	600
1921-16	fish fork	181	2	921160	300
1921-17	fish knife	202	2	921177	300
1921-10	salad server	203	2,5	921108	1
1921-11	gravy ladle	174	2,5	921115	1
1921-12	serving spoon	208	2,2	921122	1

Elégance

966 - 2,5 mm - 18-10



Article	Description	Length (mm)	Gage (mm)	EAN 13: 5413521+	Master (Pcs)
966-1	table fork	194	2,5	966017	300
966-2	table spoon	194	2,5	966024	300
966-5	table knife mono	218	69 gr	966055	300
966-14	dessert fork	175	2	966147	300
966-15	dessert spoon	177	2	966154	300
966-6	dessert knife mono	190	56 gr	966062	300
966-3	tea spoon	128	2	966031	600
966-26	mocca spoon	113	1,8	966260	600
966-4	cake fork	148	2	966048	600
966-16	fish fork	176	2	966161	300
966-17	fish knife	194	2	966178	300
966-7	soup ladle	303	2,5	966079	1
966-8	cake server	240	2,5	966086	1
966-9	chips server	222	2,5	966093	1
966-10	salad server	196	2,5	966109	1
966-11	gravy ladle	167	2,5	966116	1
966-12	serving spoon	227	2,5	966123	1

Auteuil

972 - 2,5 mm - 18-10



Article	Description	Length (mm)	Gage (mm)	EAN 13: 5413521+	Master (Pcs)
972-1	table fork	195	2,5	972018	300
972-2	table spoon	198	2,5	972025	300
972-5	table knife mono	213	96 gr	972056	240
972-3	tea spoon	143	2	972032	600
972-26	mocca spoon	121	1,5	972261	600
972-4	cake fork	144	2	972049	600
972-45	steak knife	229	88 gr	972452	240
972-8	cake server	233	2	972087	1
972-9	chips server	228	2,5	972094	1
972-12	serving spoon	204	2	972124	1

Utah

973 - 2,5 mm - 18-10



Article	Description	Length (mm)	Gage (mm)	EAN 13: 5413521+	Master (Pcs)
973-1	table fork	194	2,5	973015	300
973-2	table spoon	199	2,5	973022	300
973-5	table knife mono	215	90 gr	973053	120
973-14	dessert fork	177	2	973145	300
973-15	dessert spoon	175	2	973152	300
973-6	dessert knife mono	198	69 gr	973060	300
973-3	tea spoon	147	2	973039	600
973-26	mocca spoon	121	1,8	973268	600
973-4	cake fork	147	2	973046	600
973-45	steak knife	225	82 gr	973459	240
973-34	zakouski spoon	123	2	973343	1
973-8	cake server	232	2	973084	1
973-9	chips server	225	2,5	973091	1
973-11	gravy ladle	185	2	973114	1

Orly

1420 - 2,5 mm - 18-10



Article	Description	Length (mm)	Gage (mm)	EAN 13: 5413521+	Master (Pcs)
1420-1	table fork	192	2,5	420014	300
1420-2	table spoon	194	2,5	420021	300
1420-5	table knife mono	213	66 gr	420052	300
1420-14	dessert fork	184	2	420144	300
1420-15	dessert spoon	180	2	420151	300
1420-6	dessert knife mono	196	60 gr	420069	300
1420-3	tea spoon	139	2	420038	600
1420-26	mocca spoon	115	1,7	420267	600
1420-4	cake fork	144	1,7	420045	600
1420-17	fish knife	210	2	420175	300
1420-33	soup spoon	177	2	420335	300
1420-34	zakouski spoon	125	2	420342	1
1420-7	soup ladle	311	2,8	420076	1
1420-8	cake server	25	2,5	420083	1
1420-9	chips server	250	2,5	420090	1
1420-10	salad server	205	3	420106	1
1420-11	gravy ladle	170	2,5	420113	1
1420-12	serving spoon	226	2,5	420120	1

Olga

963 - 2,2 mm - 18-10













Article	Description	Length (mm)	Gage (mm)	EAN 13: 5413521+	Master (Pcs)
963-1	table fork	199	2,2	963016	300
963-2	table spoon	194	2	963023	300
958-5S	table knife mono	227	64 gr	958050	300
963-3	tea spoon	137	1,8	963030	600

Salsa

982 - 2,5 mm - 18-0













Article	Description	Length (mm)	Gage (mm)	EAN 13: 5413521+	Master (Pcs)
982-1	 table fork	204	2,5	982017	300
982-2	 table spoon	202	2,5	982024	300
982-5	 table knife mono	220	77 gr	982055	240
982-14	 dessert fork	185	2	982147	300
982-15	 dessert spoon	183	2	982154	300
982-6	 dessert knife mono	202	59 gr	982062	240
982-3	 tea spoon	140	1,8	982031	600
982-26	 mocca spoon	114	1,5	982260	600
982-4	 cake fork	140	1,8	982048	600
982-17	 fish knife	199	2	982178	300
982-40	 fruit/butter knife	159	41 gr	982406	300

Fjord

1900 - 2,5 mm - 18-0















Article		Description	Length (mm)	Gage (mm)	EAN 13: 5413521+	Master (Pcs)
1900-1		table fork	211	2,5	900011	300
1900-2		table spoon	209	2,5	900028	300
1900-5		table knife mono	235	71 gr	900059	120
1900-14		dessert fork	186	1,8	900141	300
1900-15		dessert spoon	185	1,8	900158	300
1900-6		dessert knife mono	208	52 gr	900066	240
1900-3		tea spoon	138	2	900035	600
1900-26		mocca spoon	100	1	900264	1200
1900-17		fish knife	211	1,8	900172	300
1900-25		cocktail spoon	197	2	900257	300
1900-34		zakouski spoon	120	1,8	900349	1

Doria

8004 - forged - 18-0



Article	Description	Length (mm)	Gage (mm)	EAN 13: 5413521+	Master (Pcs)
8004-1	 table fork	193	-	804012	300
8004-2	 table spoon	193	-	804029	300
8004-5	 table knife mono	211	63 gr	804050	240
8004-3	 tea spoon	152	-	804036	600
8004-26	 mocca spoon	125	-	804265	600
8004-4	 cake fork	152	-	804043	600
8004-45	 steak knife	209	58 gr	804456	240
8004-46	 steak fork	192	-	804463	300
8004-8	 cake server	255	-	804081	1
8004-10	 salad server	214	-	804104	1
8004-11	 gravy ladle	184	-	804111	1
8004-12	 serving spoon	199	-	804128	1

Scandinave

8060 - 3,0 mm - 18-0



Article	Description	Length (mm)	Gage (mm)	EAN 13: 5413521+	Master (Pcs)
8060-1	table fork	190	3	806016	300
8060-2	table spoon	193	3	806023	300
8060-5	table knife mono	215	82 gr	806054	240
8060-14	dessert fork	182	2,5	806146	300
8060-15	dessert spoon	183	2,5	806153	300
8060-6	dessert knife mono	207	69 gr	806061	300
8060-3	tea spoon	138	2	806030	600
8060-4	cake fork	138	2	806047	600
8060-16	fish fork	190	2,5	806160	300
8060-17	fish knife	205	2,5	806177	300

Concorde

1400 - 2,5 mm - 18-0



Article	Description	Length (mm)	Gage (mm)	EAN 13: 5413521+	Master (Pcs)
1400-1	table fork	192	2,2	400016	300
1400-2	table spoon	193	2,2	400023	300
1400-5	table knife mono	212	66 gr	400054	300
1400-14	dessert fork	184	2	400146	300
1400-15	dessert spoon	179	2	400153	300
1400-6	dessert knife mono	196	60 gr	400061	300
1400-3	tea spoon	139	2	400030	600
1400-4	cake fork	142	2	400047	600
1400-17	fish knife	290	2	400177	300
1400-7	soup ladle	311	2,8	400078	1
1400-8	cake server	256	2,5	400085	1
1400-9	chips server	250	2,5	400092	1
1400-10	salad server	205	3	400108	1
1400-11	gravy ladle	170	2,5	400115	1
1400-12	serving spoon	226	2,5	400122	1

Ingres

1700 - 2,5 mm - 18-0



Article	Description	Length (mm)	Gage (mm)	EAN 13: 5413521+	Master (Pcs)
1700-1	table fork	209	2,5	170018	300
1700-2	table spoon	210	2,5	170025	300
1700-5	table knife mono	235	97 gr	170056	120
1700-14	dessert fork	184	2,5	170148	300
1700-15	dessert spoon	184	2,5	170155	300
1700-6	dessert knife mono	211	70 gr	170063	240
1700-3	tea spoon	144	2	170032	600
1700-26	mocca spoon	118	2	170261	600
1700-4	cake fork	148	2	170049	600
1700-16	fish fork	181	2,5	170162	300
1700-17	fish knife	194	2,5	170179	300
1700-25	cocktail spoon	195	2	170254	300
1700-19	oyster fork	134	2	170193	600
1700-20	snail fork	144	2	170209	600
1700-7	soup ladle	305	2,5	170070	1
1700-8	cake server	248	2,5	170087	1
1700-9	chips server	248	2,5	170094	1
1700-10	salad server	195	2,5	170100	1
1700-11	gravy ladle	169	2,5	170117	1
1700-12	serving spoon	233	2,5	170124	1

Lipsi

2040 - 2,5 mm - 18-0



Article	Description	Length (mm)	Gage (mm)	EAN 13: 5413521+	Master (Pcs)
2040-1	table fork	206	2,5	204010	300
2040-2	table spoon	200	2,5	204027	300
2040-5	table knife mono	228	85 gr	204058	240
2040-14	dessert fork	190	2,5	204140	300
2040-15	dessert spoon	185	2,5	204157	300
2040-6	dessert knife mono	210	77 gr	204065	240
2040-3	tea spoon	141	2	204034	600
2040-26	mocca spoon	118	2	204263	600
2040-4	cake fork	150	2	204041	600
2040-16	fish fork	188	2,5	204164	300
2040-17	fish knife	199	2,5	204171	300
2040-7	soup ladle	310	2,5	204072	1
2040-8	cake server	251	2,5	204089	1
2040-9	chips server	247	2,5	204096	1
2040-10	salad server	206	2,5	204102	1
2040-11	gravy ladle	165	2,5	204119	1
2040-12	serving spoon	205	2,5	204126	1

Opera

968 - 2,5 mm - 18-0



Article	Description	Length (mm)	Gage (mm)	EAN 13: 5413521+	Master (Pcs)
968-1	table fork	209	2,5	968011	300
968-2	table spoon	208	2,5	968028	300
968-5	table knife mono	233	81 gr	968059	240
968-14	dessert fork	186	2,5	968141	300
968-15	dessert spoon	185	2,5	968158	300
968-6	dessert knife mono	203	56 gr	968066	240
968-3	tea spoon	143	2	968035	600
968-26	mocca spoon	118	2	968264	600
968-4	cake fork	146	2	968042	600
968-16	fish fork	174	2,5	968165	300
968-17	fish knife	196	2,5	968172	300
968-45	steak knife	223	84 gr	968455	240

Ecobaguette

2611 - 2,5 mm - 18-0



Article	Description	Length (mm)	Gage (mm)	EAN 13: 5413521+	Master (Pcs)
2611-1	table fork	208	2,5	611016	300
2611-2	table spoon	208	2,5	611023	300
2610-5	table knife mono	238	111 gr	261051	240
2611-14	dessert fork	182	2	611146	300
2611-15	dessert spoon	180	2	611153	300
2610-6	dessert knife mono	212	84 gr	261068	240
2611-3	tea spoon	138	1,8	611030	600
2611-26	mocca spoon	111	1,8	611269	600
2611-4	cake fork	145	1,8	611047	600
2611-16	fish fork	174	2	611160	300
2611-17	fish knife	195	2	611177	300

Vieux-Paris

1300 - 2,5 mm - 18-0



Article	Description	Length (mm)	Gage (mm)	EAN 13: 5413521+	Master (Pcs)
1300-1	table fork	210	2,5	130012	300
1300-2	table spoon		-	130029	300
1300-5	table knife mono	231	87 gr	130050	240
1300-14	dessert fork	184	2,2	130142	300
1300-15	dessert spoon	182	2,2	130159	300
1300-6	dessert knife mono	210	68 gr	130067	240
1300-3	tea spoon	145	2	130036	300
1300-26	mocca spoon	117	2,2	130265	300
1300-16	fish fork	185	2,2	130166	300
1300-17	fish knife	198	2,2	130173	300
1300-25	cocktail spoon	193	2,5	130258	300

Isabelle

2010 - 2,2 mm - 18-0



Article	Description	Length (mm)	Gage (mm)	EAN 13: 5413521+	Master (Pcs)
2010-1	table fork	205	2,2	201019	300
2010-2	table spoon	198	2,2	201026	300
2010-5	table knife mono	228	71 gr	201057	240
2010-14	dessert fork	195	2,2	201149	300
2010-15	dessert spoon	188	2,2	201156	300
2010-6	dessert knife mono	208	67 gr	201064	300
2010-3	tea spoon	142	1,8	201033	600
2010-4	cake fork	148	1,8	201040	600
2010-16	fish fork	191	2,2	201163	300
2010-17	fish knife	201	2,2	201170	300
2010-19	oyster fork	136	1,8	201194	600
2010-20	snail fork	141	1,8	201200	600
2010-8	cake server	262	2,5	201088	1
2010-9	chips server	254	2,5	201095	1
2010-10	salad server	196	2,2	201101	1
2010-11	gravy ladle	172	2,5	201118	1

Aude

1922 - 2,2 mm - 18-0



Article	Description	Length (mm)	Gage (mm)	EAN 13: 5413521+	Master (Pcs)
1922-1	table fork	196	2,2	922013	300
1922-2	table spoon	198	2,2	922020	300
1922-5	table knife mono	230	81 gr	922051	240
1922-14	dessert fork	177	1,8	922143	300
1922-15	dessert spoon	178	1,8	922150	300
1922-6	dessert knife mono	202	60 gr	922068	300
1922-3	tea spoon	144	1,8	922037	600
1922-26	mocca spoon	116	1,5	922266	600
1922-4	cake fork	147	1,8	922044	600
1922-16	fish fork	180	1,8	922167	300
1922-17	fish knife	203	1,8	922174	300
1922-25	cocktail spoon	195	2	922259	300
1922-7	soup ladle	287	2	922075	1
1922-8	cake server	235	2	922082	1
1922-10	salad server	199	2	922105	1
1922-12	serving spoon	208	2	922129	1

Octo

1790 - 2,2 mm - 18-0



























Article	Description	Length (mm)	Gage (mm)	EAN 13: 5413521+	Master (Pcs)
1790-1	table fork	197	2,5	790018	300
1790-2	table spoon	195	2,5	790025	300
1790-5	table knife mono	231	91 gr	790056	120
1790-14	dessert fork	190	2,2	790148	300
1790-15	dessert spoon	179	2,2	790155	300
1790-6	dessert knife mono	213	79 gr	790063	240
1790-3	tea spoon	138	1,8	790032	600
1790-26	mocca spoon	108	1,8	790261	600
1790-4	cake fork	144	1,8	790049	600
1790-16	fish fork	190	2,2	790162	300
1790-17	fish knife	199	2,2	790179	300
1790-25	cocktail spoon	189	1,8	790254	300
1790-19	oyster fork	132	1,8	790193	600
1790-20	snail fork	137	1,8	790209	600
1790-7	soup ladle	285	2,5	790070	1
1790-8	cake server	243	2,5	790087	1
1790-9	chips server	250	2,5	790094	1
1790-11	gravy ladle	180	2,5	790117	1
1790-12	serving spoon	221	2,5	790124	1

Frida

958 - 2,2 mm - 18-0



Article	Description	Length (mm)	Gage (mm)	EAN 13: 5413521+	Master (Pcs)
958-1	 table fork	201	2,2	958012	300
958-2	 table spoon	194	2	958029	300
958-5S	 table knife mono	227	64 gr	958050	300
958-14	 dessert fork	166	2	958142	300
958-15	 dessert spoon	168	2	958159	300
958-6S	 dessert knife mono	194	40 gr	958067	300
958-3	 tea spoon	135	1,8	958036	600
958-26	 mocca spoon	121	1,8	958265	600
958-4	 cake fork	143	1,8	958043	600
958-16	 fish fork	196	2	958166	300
958-17	 fish knife	205	2	958173	300
958-4S	 steak knife	233	61 gr	958456	300
958-25	 cocktail spoon	199	1,8	958258	300
958-18	 icecream spoon	137	1,8	958180	600
958-19	 oyster fork	135	1,8	958197	600
958-20	 snail fork	143	1,8	958203	600
958-7	 soup ladle	310	2,8	958074	1
958-8	 cake server	250	2,5	958081	1
958-9	 chips server	250	2,5	958098	1
958-10	 salad server	195	2	958104	1
958-11	 gravy ladle	162	2,5	958111	1
958-12	 serving spoon	246	2,5	958128	1
958-21	 serving fork	208	2	958210	1
958-27B	 butter knife mono	170	2	958272	1
958-39	 zakouski fork	117	1,8	958395	600

Roma

301 - 2,2 mm - 18-0



Article	Description	Length (mm)	Gage (mm)	EAN 13: 5413521+	Master (Pcs)
301-1	table fork	194	2,2	301016	300
301-2	table spoon	195	2	301023	300
301-5	table knife mono	219	73 gr	301054	300
301-3	tea spoon	152	1,8	301030	600
301-4	cake fork	153	1,8	301047	600

Diva

1721 - 2,0 mm - 18-0







Article	Description	Length (mm)	Gage (mm)	EAN 13: 5413521+	Master (Pcs)
1721-1	table fork	207	2	721012	300
1721-2	table spoon	205	2	721029	300
1721-3	tea spoon	147	1,2	721036	600
1721-26	mocca spoon	110	1	721265	600
1721-45	steak knife	229	64 gr	721456	240

Futura

314 - 2,0 mm - 18-0









Article	Description	Length (mm)	Gage (mm)	EAN 13: 5413521+	Master (Pcs)
314-1	 table fork	193	2	314016	300
314-2	 table spoon	192	2	314023	300
314-5	 table knife mono	203	70 gr	314054	180
314-3	 tea spoon	125	1,5	314030	600
314-4	 cake fork	135	1,5	314047	600

New Carmen

315 - 2,0 mm - 18-0



Article	Description	Length (mm)	Gage (mm)	EAN 13: 5413521+	Master (Pcs)
315-1	 table fork	189	2	315013	300
315-2	 table spoon	188	2	315020	300
315-5	 table knife mono	210	57 gr	315051	300
315-3	 tea spoon	134	1,5	315037	600
315-26	 mocca spoon	114	1,5	315266	600
315-4	 cake fork	137	1,5	315044	600
315-25	 cocktail spoon	173	1,5	315259	300

Verona

319 - 2,2 mm - 18-0



Article	Description	Length (mm)	Gage (mm)	EAN 13: 5413521+	Master (Pcs)
319-1	table fork	197	2,2	319011	300
319-2	table spoon	189	2	319028	300
319-5	table knife mono	212	62 gr	319059	240
319-3	tea spoon	133	1,5	319035	600
319-26	mocca spoon	108	1,5	319264	600

Tumble polish with additional side polish

Modena

957 - 2,0 mm - 18-0









Article	Description	Length (mm)	Gage (mm)	EAN 13: 5413521+	Master (Pcs)
957-1	table fork	189	2	957015	300
957-2	table spoon	186	1,8	957022	300
957-5	table knife mono	211	40 gr	957053	300
957-3	tea spoon	137	1,5	957039	600
957-26	mocca spoon	115	1,2	957268	600

Tumble polish

Vesuve

951 - 2,0 mm - 18-0



Article	Description	Length (mm)	Gage (mm)	EAN 13: 5413521+	Master (Pcs)
951-1	 table fork	186	2	951013	300
951-2	 table fork	188	1,8	951020	300
951-5	 table spoon	209	40 gr	951051	300
951-3	 table knife mono	137	1,5	951037	600
951-26	 tea spoon	113	1,5	951266	600
951-4	 mocca spoon	143	1,5	951044	600
951-25	 cake fork	199	1,5	951259	300

Tumble polish

953 - 1,0 mm - 18-0

Article	Description	Length (mm)	Gage (mm)	EAN 13: 5413521+	Master (Pcs)
953-3	 tea spoon	130	1	953031	1200

Tumble polish



Hôtel "de Witte Lelie"
Antwerp - 17th century *small luxury hotel*





eternum *signature*

eternum



Coffee / Tea

106

124



Serving plates

109

127



Tableware

111

128



Bar

116

133



Buffet

119



Special cutlery

122

134

How to read the data?

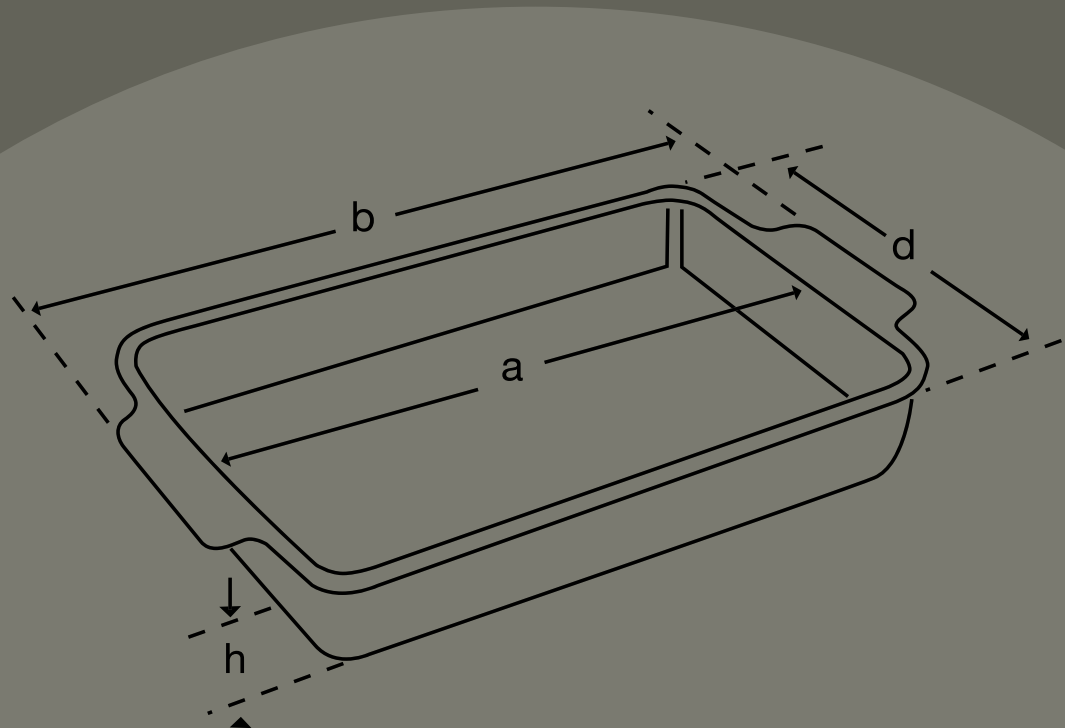

Code :

a (mm) = interior length
longueur intérieure
binnenlengte
Innenmass
lunghezza interna
longitud interior
długość wewnętrzna
внутренняя длина
εσωτερικό μήκος

i (cl) = capacity
capacité
inhoud
Inhalt
capacità
capacidad
pojemność
вместимость
χωρητικότητα

b (mm) = exterior length
longueur extérieure
buitenlengte
Aussenmass
lunghezza esterna
longitud exterior
długość zewnętrzna
внешняя длина
εξωτερικό μήκος

e (mm) = thickness
épaisseur
dikte
Materialstärke
spessore
espesor
grubość
толщина
πάχος

d (mm) = width
largeur
breedte
Breite
larghezza
anchura
szerokość
ширина
πλάτος

h (mm) = height
hauteur
hoogte
Höhe
altezza
altura
wysokość
высота
ύψος

Coffee pot "classic"

Cafetière • Koffiepot • Kaffeekanne • Caffettiera • Cafetera •
Czajniczek do kawy • Кофейник • Καφετιέρα

Ref	a	b	d	h	i	e	gr	Master (Pcs)	Steel	EAN 5413521+
6035	58			145	35	1,3	328	36	18/10	060357
6050	65			168	50	1,5	443	24	18/10	060500
6090	77			190	90	1,5	592	12	18/10	060906
6160	95			230	160	1,5	860	12	18/10	061606



Tea pot "classic"

Théière • Theepot • Teekanne • Teiera • Tetera • Czajniczek
do herbaty • Чайник • Τσαγιέρα

Ref	a	b	d	h	i	e	gr	Master (Pcs)	Steel	EAN 5413521+
6235	65			128	35	1,3	347	36	18/10	062351

Milk jug "classic"

Crémier • Melkpot • Milchkanne • Bricchetto per panna •
Casaro Lechera • Dzbaneek na śmietankę • Кувшинчик
для сливок • Σκεύος κρέμας γάλακτος

Ref	a	b	d	h	i	e	gr	Master (Pcs)	Steel	EAN 5413521+
6423	62			90	23	1,0	171	48	18/10	064232
6435	58			117	35	1,3	275	36	18/10	064355
6460	65			137	00	1,5	366	24	18/10	064607



Sugar pot "classic"

Sucrier • Suikerpot • Zuckerdose • Zuccheriera •
Azucarero • Cukiernica • Сахарница • Захарієра

Ref	a	b	d	h	i	e	gr	Master (Pcs)	Steel	EAN 5413521+
6628	68			115	28	1,0	279	48	18/10	066281



Coffee pot "luxe"

Cafetière • Koffiepot • Kaffeekanne • Caffettiera
Cafetera • Czajniczek do kawy • Кофейник • Кафетієра

Ref	a	b	d	h	i	e	gr	Master (Pcs)	Steel	EAN 5413521+
4035	57			100	35	1,0	308	48	18/10	040359
4060	68			119	60	1,0	423	40	18/10	040601
4100	81			148	100	1,0	682	20	18/10	041004

Tea pot "luxe"

Théière • Theepot • Teekanne • Teiera • Tetera
• Czajniczek do herbaty • Чайник • Тсaгiєpa

Ref	a	b	d	h	i	e	gr	Master (Pcs)	Steel	EAN 5413521+
4235	69			90	35	1,0	340	36	18/10	042353
4260	81			100	60	1,0	418	24	18/10	042605



Milk jug "luxe"

Crémier • Melkpot • Milchkanne • Bricchetto per panna • Casaro Lechera • Dzbanek na śmietankę • Кувшинчик для сливок • Σκεύος κρέμας γάλακτος

Ref	a	b	d	h	i	e	gr	Master (Pcs)	Steel	EAN 5413521+
4415	48			64	15	1,0	116	12/144	18/10	044159
4435	65			84	35	1,0	262	12/72	18/10	044357
4460	77			100	60	1,0	385	12/48	18/10	044609



Sugar pot "luxe"

Sucrier • Suikerpot • Zuckerdose • Zuccheriera • Azucarero • Cukiernica • Сахарница • Ζαχαριέρα

Ref	a	b	d	h	i	e	gr	Master (Pcs)	Steel	EAN 5413521+
4623	67			67	23	1,0	193	12/96	18/10	046238



Rectangular tray

Plateau rectangulaire • Rechthoekige schaal • rechteckige Schale • Vassaoio rettangolare • Bandeja Rectangular • Taca prostokątna • Прямоугольный Поднос • ορθογώνιος δίσκος

Ref	a	b	d	h	i	e	gr	Master (Pcs)	Steel	EAN 5413521+
630	255	305	253	17		1,0	760	10/20	18/10	006300
638	335	384	298	17		1,2	1100	10/20	18/10	006386



Rectangular tray with handles

Plateau rectangulaire • Rechthoekige schaal • rechteckige Schale • Vassaoio rettangolare • Bandeja Rectangular • Taca prostokątna • Прямоугольный Поднос • ορθογώνιος δίσκος

Ref	a	b	d	h	i	e	gr	Master (Pcs)	Steel	EAN 5413521+
666H	540	773	471			1,5	3700	3	18/10	066487
668H	660	893	550			1,5	4270	2	18/10	066885



Round tray

Plateau Rond • Ronde Schaal • runde Schale • Vassoio Rotondo
Bandeja Redonda • Τάσα οκτάγωνα • Круглый подно • Στρογγυλός δίσκος

Ref	a	b	d	h	i	e	gr	Master (Pcs)	Steel	EAN 5413521+
230	250	300		21		1,0	560	10/40	18/10	002302
237	310	370		21		1,0	920	10/20	18/10	002371
241	355	410		21		1,0	1500	5/15	18/10	002418



Rectangular tray

Plateau Rectangulaire • Rechthoekige Schaal
• rechteckige Schale • Vassoio rettangolare
• Bandeja Rectangular • Τάσα prostokątna
• Прямоугольный Поднос • ορθογώνιος δίσκος

Ref	a	b	d	h	i	e	gr	Master (Pcs)	Steel	EAN 5413521+
325	215	252	196	16		1,0	376	10/40	18/10	003255
331	245	311	238	21		1,0	614	10/20	18/10	003316
337	315	370	270	23		1,0	840	10/20	18/10	003378
341	333	412	315	23		1,2	1280	5/10	18/10	003415
346	373	463	356	23		1,2	1600	4/8	18/10	003460

Rectangular Tray With Handles

Plateau rectangulaire • Rechthoekige schaal • rechteckige Schale • Vassoio rettangolare
Bandeja rectangular • Τάσα prostokątna • Прямоугольный поднос • ορθογώνιος δίσκος

Ref	a	b	d	h	i	e	gr	Master (Pcs)	Steel	EAN 5413521+
346H	577	463	356	23		1,2	1800	4/8	18/10	034600
351H	425	628	390	23		1,2	2200	3/6	18/10	035102



Bread basket

Corbeille à pain • Broodschaal • Brotschale • Vassoio portapane • Panera • Koszyk na chleb • Чаша для хлеба • Δίσκος ψωμιού

Ref	a	b	d	h	i	e	gr	Master (Pcs)	Steel	EAN 5413521+
322		308	171	45		0,9	365	10/40	18/10	003224



Butter dish

Beurrier • Boterschaal • Butterschale • Portaburro • Mantequera • Pojemnik na masło • Маслёнка • Βουτιριέρα

Ref	a	b	d	h	i	e	gr	Master (Pcs)	Steel	EAN 5413521+
507	57	90		75		1,0	208	1/54	18/10	005075

Cooling butter dish

Beurrier • Boterschaal • Butterschale • Portaburro • Mantequera • Pojemnik na masło • Маслёнка • Βουτιριέρα

Ref	a	b	d	h	i	e	gr	Master (Pcs)	Steel	EAN 5413521+
510	146	83		70	10	0,7	349	36	18/10	005105



Gravy boat

Saucière • Sauskom • Sauciere • Salsiera • Salsera • Sosjerka
• Соусник • -Σαλτσιέρα

Ref	a	b	d	h	i	e	gr	Master (Pcs)	Steel	EAN 5413521+
306		157	73	87	15	1,0	140	12/96	18/10	003064
303		192	82	96	30	1,0	210	12/72	18/10	003033



Dome cover

Cloche de table • Tafelklok • Speisehauben • Coprivivande •
Campana de mesa • Klosz do przykrywania potraw • купольная
крышка • Θόλος καλύψεως

Ref	a	b	d	h	i	e	gr	Master (Pcs)	Steel	EAN 5413521+
522	218	228				1,5	800	5/20	18/10	005228
524	240	255				1,5	960	5/20	18/10	005242
526	255	265				1,5	1020	5/20	18/10	005266

Condiment sets

Sets à condiments • Condimentenset • Gewürzsets • Set per
condimenti • Servicio de condimentos • Zestaw do przypraw •
Наборы для специй • Σετ αρτυμάτων

	Ref	a	b	d	h	i	e	gr	Master (Pcs)	Steel	EAN 5413521+
oil - vinegar	2504-E		70	130	184			718	28	18/10	025042
cheese pot	2506-E		120	95	125			502	30	18/10	025066
salt - pepper - mustard	2523-E		110	95	125			534	30	18/10	025233
salt - pepper - mustard - oil - vinegar	2525-E		110	141	184			1140	22	18/10	025257
salt - pepper	2702-E		50	188	150			322	80	18/10	027022



Plat à escargots • Slakkenschotel • Schneckenteller • Piatto per lumache • Fuente para caracoles • Talerz na ślimaki • блюдо для улиток • Πιάτο σαλιγκαριών

Snail dish

Ref	a	b	d	h	i	e	gr	Master (Pcs)	Steel	EAN 5413521+
406	125	172		10		0,8	182	12/72	18/10	004061
412	165	230		10		0,8	204	12/72	18/10	004122



Snail tong

Pince à escargot • Slakkentang • Schneckenzange • Pinza per lumache • Pinza caracoles • Szczypce Do ślimaków • Блюдо для улиток • Πιάτο σαλιγκαριών

Ref	a	b	d	h	i	e	gr	Master (Pcs)	Steel	EAN 5413521+
2946							42	12/240	18/10	029460

Lobster Cracker

Pince à homard • Kreeftenschaar • Hummerschere • Pinza per aragosta • Kinza bogavante • Szczypce do homarów • Злоумышленник омара • Σπαστήρας αστακού

Ref	a	b	d	h	i	e	gr	Master (Pcs)	Steel	EAN 5413521+
3011	180						132	12/288	18 Cr	030114



Finger bowl

Rince-doigts • Vingerkom • Fingerschale • Ciotola lava-dita • Lavados • Miseczka do mycia palców • Чаша для омовения пальцев • Μπολ χεριών

Ref	a	b	d	h	i	e	gr	Master (Pcs)	Steel	EAN 5413521+
580		110		35	25	1,5	134	10/100	18/10	005808

Ice cream cup

Coupe à glace • Ijsbeker • Eisbecher • Coppetta da gelato • Copa helado • Pucharek do lodów • Вазочка для мороженого • Κούπα παγωτού

Ref	a	b	d	h	i	e	gr	Master (Pcs)	Steel	EAN 5413521+
3020	106			87	20	1,5	183	10/80	18/10	030206



Napkin rings (set of 4 pieces)

Ronds de serviette • Servettenring • Serviettenring • Portatovaglioli • Anillos de servilleta • Pierścienie na serwetki • Колец для салфеток • δαχτυλίδια πετσέτας

Ref	a	b	d	h	i	e	gr	Master (Pcs)	Steel	EAN 5413521+
15924		50	39			1,0	160	24	18/10	159242

Coaster

Sous-verres et bouteille • Onderzetter • Untersetzer • Sotto • Posas • Podstawka - Подставки • Σουβέρ

	Ref	a	b	d	h	i	e	gr	Master (Pcs)	Steel	EAN 5413521+
for glass	15919	75	103		10		0,6	290	60		159198
for bottle	15920	85	113		10		0,6	120	12/72		159204



Crum scoop

Ramasse-miettes • Kruidmeldief • Tischbesen • Togli briciole -
Recogemigas • Zestaw do okruszków • Κροσκα • Εργαλείο απομάκρυνσης
ψίχουλων

Ref	a	b	d	h	i	e	gr	Master (Pcs)	Steel	EAN 5413521+
770		152	29			1,0	39	12/600	18/10	007703



Banket stand

Porte n° • Nummerhouder • Nummerständer • Porta numero •
Portanúmero • Podstawka na numerek • Банкетная стойка • Βάση
πάγκου

Ref	a	b	d	h	i	e	gr	Carton	Steel	EAN 5413521+
2020				200			188	10/100	18/10	020207
2030				300			218	10/50	18/10	020306
2040				400			248	10/50	18/10	020405

Vase

Soliflor • Vaasje • Vase • Soliflor • Florero • Wazon Soliflor • Βαза • Βάζο

Ref	a	b	d	h	i	e	gr	Master (Pcs)	Steel	EAN 5413521+
2001	25			185		1,0	316	15/60	18/10	020016



Champagne bucket

Seau à champagne • Champagnekoeler • Sektkühler • Secchiello per champagne • Cubo de champán • Wiaderko na szampana • Ведёрко для шампанского • Σαμπανιέρα

Ref	a	b	d	h	i	e	gr	Master (Pcs)	Steel	EAN 5413521+
2908	213			210	600	0,9	1100	4	21 Cr	029088



Champagne bucket stand

Pied pour seau • Voet voor koeler • Ständer für Kühler • Base per secchiello champagne • Pie de champanero • Podstawka pod wiaderko do szampana • Поддержка для шампанского ведро • Πόδι σαμπανιέρας

Ref	a	b	d	h	i	e	gr	Master (Pcs)	Steel	EAN 5413521+
2900	180	218	300	595		1,0	2150	4	18/10	029002



Champagne bucket

Seau à champagne • Champagnekoeler • Sektkühler • Secchiello per champagne • Cubo de champán • Wiaderko na szampan • Ведёрко для шампанского • Σαμπανιέρα

Ref	a	b	d	h	i	e	gr	Master (Pcs)	Steel	EAN 5413521+
2906	214			210	450	1,0	1400	1	18/10	029064



Ice bucket

Seau à glace • Ijsemmer • Eiskühler • Secchiello per il ghiaccio • Cubo de hielo • Wiaderko na lód • Ведерко со льдом • Παγωπιέρα

Ref	a	b	d	h	i	e	gr	Carton	Steel	EAN 5413521+
2910	107	125		120	100	1,0	392	30	18/10	029101

Ice tong

Pince à glace • Ijstang • Eiszange • Pinza da ghiaccio • Pinza hielo • Szczypce do lodu • Щипцы для льда • Λαβίδα πάγου

Ref	a	b	d	h	i	e	gr	Master (Pcs)	Steel	EAN 5413521+
2927	180					1,0	45	60/240	18 Cr	029279



Shaker

Shaker • Shaker • Shaker • Shaker • Coctelera • Shaker • Шейкер • Σέικερ

Ref	a	b	d	h	i	e	gr	Master (Pcs)	Steel	EAN 5413521+
2912				240	70		430	48	18/10	029125



Punch bowl

Ref	a	b	d	h	i	e	gr	Master (Pcs)	Steel	EAN 5413521+
484		455		250	150	1,0	2700	2	18/10	004849

Liqueur ladle

Louche à liqueur • Likeurlepel • Likörlöffel • Mestolo per liqueore • Cucharón de licor • Chochelka do likieru • Ковш напитоков • Κουτάλα λικέρ

Ref	a	b	d	h	i	e	gr	Master (Pcs)	Steel	EAN 5413521+
780		300				4,0	60	100	18/10	007802



Chafing dish brass feet

Roll-top chafing dish gastronorm 1/1

Ref	a	b	d	h	i	e	gr	Master (Pcs)	Steel	EAN 5413521+
CD-660	530	660	435	430			17600	1	18/10	346604



Round chafing dish brass feet

Chafing dish rond • Cd rond • Cd rund • Scaldavivande rotondo
• Cd redondo • Okrągły podgrzewacz • Круглый жаровня
• Στρογγυλό σκεύος Ζεστάματος

Ref	a	b	d	h	i	e	gr	Master (Pcs)	Steel	EAN 5413521+
CD-50	385	500		450			13600	1	18/10	340503

Coffee dispenser brass feet

Urne à café • Koffieverdeler • Kaffeespender • Dosatore caffè • Urna de café • Termos do kawy •
Электрический дозатор • Δοσομετρητής καφέ

Ref	a	b	d	h	i	e	gr	Master (Pcs)	Steel	EAN 5413521+
CD-12L	215	273		580	1200		6400	1	18/10	340121



Chafing dish stainless steel feet

Roll-top chafing dish gastronorm 1/1

Ref	a	b	d	h	i	e	gr	Master (Pcs)	Steel	EAN 5413521+
CDG-1/1	530	660	435	430			17400	1	18/10	351103



Round chafing dish stainless steel

Chafing dish rond • Cd rond • Cd rund • Scaldavivande rotondo • Cd redondo
• ΟΚραγτύ podgrzewacz • Круглый жаровня • Στρογγυλό σκεύος Ζεστάματος

Ref	a	b	d	h	i	e	gr	Master (Pcs)	Steel	EAN 5413521+
CDR-46	385	500		450			13500	1	18/10	350465

Coffee dispenser stainless steel feet

Urne à café • Koffieverdeler • Kaffeespender • Dosatore caffè
• Urna de café • Термос до кауу • КЭлектрический дозатор • Δοσομετρητής καφέ

Ref	a	b	d	h	i	e	gr	Master (Pcs)	Steel	EAN 5413521+
CDS-12L	215	273		580	1200		5000	1	18/10	350120



Double soup station

Ensemble double soupières • Set 2 soepkommen • Doppelte Suppenstation • Scaldavivande
• 2 Soperas • Stacja na zupę • Супница с подогревом • Σκεύος σούπας

Ref	a	b	d	h	i	e	gr	Master (Pcs)	Steel	EAN 5413521+
CD-SOUP	215			230			3900	2	18/10	349995



CD-660 + CD-soup

Food pan for gastronorm 1/1

Insert pour cd 1/1 • Binnenschotel voor cd 1/1 • Innerteller für cd 1/1 • Inserire Cd 1/1 • Plato interior cd 1/1 • Talerz cd 1/1 • Интерьер плато CD 1 / 1 • Πτολ CD 1/1

Ref	a	b	d	h	i	e	gr	Master (Pcs)	Steel	EAN 5413521+
2112		530	327	65			1170	20	18/10	021129

Appetize



	Length (mm)	Gage (mm)	Master (Pcs)	Steel	EAN : 5413521+
3030-34	99	2,0	300	18 Cr	030343
3030-39	100	2,5	600	18 Cr	030398
3030-41	228	2,5	300	18/10	030411

Zakouski spoon

Cuillère zakouski • Zakouskilepel • Zakouskilöffel • Cucchiaio zakouski • Cuchara zakouski • Łyżka do zakąsek • Ложка для закусок • Κουτάλι ορεκτικών «Zakouski»

	Length (mm)	Gage (mm)	Master (Pcs)	Steel	EAN : 5413521+
1920-34	117	2,5	300	18/10	920347



Steak knife laminated wood

Couteau steak • Steakmes • Steakmesser • Coltello da bistecca • cuchillo de carne • Nóż do steków • нож для бифштекса • Μαχαίρι Μπριζόλας

	Length (mm)	Gage (mm)	Master (Pcs)	Steel	EAN : 5413521+
764	225	-	12	13/0	007642

Steak fork laminated wood

Fourchette steak • Steakvork • Steakgabel • Forchetta da bistecca • Tenedor de carne • Widelec do steków • вилка для бифштекса • Πιρούνι μπριζόλας

	Length (mm)	Gage (mm)	Master (Pcs)	Steel	EAN : 5413521+
766	225	-	12	18/10	007666



Steak knife "pistol"

Couteau steak • Steakmes • Steakmesser • Coltello da bistecca • Cuchillo de carne • Nóż do steków • Нож для бифштекса • Μαχαίρι Μπιριζόλας

	Length (mm)	Gage (mm)	Master (Pcs)	Steel	EAN : 5413521+
999-45	233	-	12/240	18/10 + 13/0	999459



Spaghetti cutlery

Couverts spaghetti • Spaghattibestek • Spaghattibestek • Posateria spaghetti • Cub. espaguetis • Szućce do spaghetti • pokryta для спагетти • Μαχαροπήρουνα μακαρονιών

	Length (mm)	Gage (mm)	Master (Pcs)	Steel	EAN : 5413521+
2080-35	219	3,5	12/300	18/10	208353
2080-36	215	3,5	12/300	18/10	208360

Lobster fork

Curette à homard • Kreeftvork • Hummergabel • Forchetta per aragosta • Tenedor bogavante • Widelec do homarów • Вилочка для омара • Πιρούνι αστακού

Ref	Length (mm)	Gage (mm)	Master (Pcs)	Steel	EAN : 5413521+
782	204	2,5	12/300	18/10	007826
781	190	2,0	12/300	18/10	007819



Coffee pot

Cafetière • Koffiepot • Kaffeekanne • Caffettiera • Cafetera •
Czajniczek do kawy • Кофейник • Καφετιέρα

Ref	a	b	d	h	i	e	gr	Master (Pcs)	Steel	EAN 5413521+
9-212	65			110	35	1,0	186	60	18/10	092129
9-208	78			130	60	1,0	291	36	18/10	092082
9-206	90			150	100	1,0	440	24	18/10	092068
9-203	100			190	150	1,0	566	24	18/10	092037
9-217	110			210	200	1,0	651	12	18/10	092174



Tea pot

Théière • Theepot • Teekanne • Teiera • Tetera • Czajniczek do herbaty • Чайник • Τσαγιέρα

Ref	a	b	d	h	i	e	gr	Master (Pcs)	Steel	EAN 5413521+
9-213	74			107	35	1,0	186	60	18/10	092136
9-209	87			112	60	1,0	291	36	18/10	092099

Coffee pot "long spout"

Cafetière • Koffiepot • Kaffeekanne • Caffettiera • Cafetera • Czajniczek do kawy • Кофейник •
Καφετιέρα

Ref	a	b	d	h	i	e	gr	Master (Pcs)	Steel	EAN 5413521+
9-231P	65			110	35	1,0	208	12/48	18/10	092310
9-232P	78			130	60	1,0	337	6/36	18/10	092327
9-233P	90			150	100	1,0	404	30	18/10	092334
9-234P	100			190	150	1,0	647	12	18/10	092341
9-235P	110			210	200	1,0	700	12	18/10	092358



Tea pot "long spout"

Théière • Theepot • Teekanne • Teiera • Tetera • Czajniczek do herbaty • Чайник • Τσαγιέρα

Ref	a	b	d	h	i	e	gr	Master (Pcs)	Steel	EAN 5413521+
9-236P	74			107	35	1,0	208	12/48	18/10	092365
9-237P	87			112	60	1,0	337	6/48	18/10	092372



Milk jug

Crèmier • Melkpot • Milchkanne • Bricchetto per panna • Lechera • Dzbaneek na śmietankę • Кувшинчик для сливок • Σκεύος κρέμας γάλακτος

Ref	a	b	d	h	i	e	gr	CMaster (Pcs)	Steel	EAN 5413521+
9-240	53			60	15	0,8	74	100	18/10	092402
9-202	75			50	23	1,0	116	24/144	18/10	092020
9-214	65			90	35	1,0	132	60	18/10	092143
9-210	78			105	60	1,0	209	36	18/10	092105
9-205	90			125	100	1,0	278	24	18/10	092051
9-204	100			165	150	1,0	494	24	18/10	092044
9-218	110			180	200	1,0	534	12	18/10	092181

Jug with ice guard

Cruche • Kruik • Krug • Brocca • Jarra • Dzbaneek • ЭКувшин • Κανάτα

Ref	a	b	d	h	i	e	gr	Master (Pcs)	Steel	EAN 5413521+
9-219	110			180	200	1,0	550	12	18/10	092198



Sugar pot

Sucrier • Suikerpot • Zuckerdose • Zuccheriera • Azucarero • Cukier-NICA • Сахарница • Ζαχαριέρα

Ref	a	b	d	h	i	e	gr	Master (Pcs)	Steel	EAN 5413521+
898	94			85	35	0,7	218	10/80	18/10	008984
9-201L	87			70	23	0,7	143	24/144	18/10	092013



Milk jug

Crèmier • Melkpot • Milchkanne • Bricchetto per panna • Lechera • DzbaneK na śmietankę • Кувшинчик для сливок • Σκεύος κρέμας γάλακτος

Ref	a	b	d	h	i	e	gr	Master (Pcs)	Steel	EAN 5413521+
2400P0.03					3	0,6	15	10/240	18/10	024007
2400P0.10					10	0,6	33	10/200	18/10	240001

Tea infuser

Cuillère à thé • Theelepел • Teelöffel • Infusore per tè • Cuchara para té • łyżeczka do herbaty • Чайник для заварки • Συσκευή διήθησης τσαγιού

Ref	a	b	d	h	i	e	gr	Master (Pcs)	Steel	EAN 5413521+
3116		150				0,5	38	24	18/10	031166



Lemon squeezer

Presse-citrons - Citroenpers - Zitronenpresse - Spremiagrumi - Exprimelimonas • Wyciskacz do cytryn • Выжималка для лимона • Λεμονοστύφτης

Ref	a	b	d	h	i	e	gr	Master (Pcs)	Steel	EAN 5413521+
2928		80	50	34			34	12/600	18/10	029286



Vegetable bowl

Légumier • Groentenschotel • Gemüseschale • Insalatiera • Plato de verduras • Naczynie do serwowania warzyw • Салатница • Μπολ λαχανικών

Ref	a	b	d	h	i	e	gr	Master (Pcs)	Steel	EAN 5413521+
112	125	145		50	40	0,7	81	12/240	18/10	001121
116	160	200		40	55	0,7	246	12/96	18/10	001169
120	208	252		55	115	0,8	294	10/60	18/10	001206

Oval tray

Plateau ovale • Ovale schotel • ovale Schale • Vassoio ovale • Bandeja ovalada • Owalny talerz • Овальное Поднос • Οβάλ δίσκος

Ref	a	b	d	h	i	e	gr	Master (Pcs)	Steel	EAN 5413521+
130	260	310	220	20		0,6	296	10/60	18/10	001305
135	300	355	255	20		0,7	380	10/40	18/10	001350
140	350	415	300	20		0,7	540	10/30	18/10	001404
145	400	460	355	20		0,8	760	10/20	18/10	001459
150	450	510	370	20		0,8	980	10/20	18/10	001503



Serving tray

Plateau de service • Serveerschotel • Serviertablett • Vassoio da portata • Bandeja • Τάσα • Раздаточный поднос • Δίσκος σερβιρίσματος

Ref	a	b	d	h	i	e	gr	Master (Pcs)	Steel	EAN 5413521+
540	350	400		32		1,0	915	24	14/1	005402



Condiment sets

Sets à condiments • Kruiden sets • Gewürzsets • Set per condimenti • Servicio de condimentos • Zestaw do przypraw • Наборы для специй • Σετ αρτιμάτων

	Ref	a	b	d	h	i	e	gr	Master (Pcs)	Steel	EAN 5413521+
salt - pepper - mustard	566/758		82	77	130			340	60	18 Cr	566583
oil - vinegar	566/761		52	112	215			560	12/48	18 Cr	566613
salt - pepper	566/768		36	77	130			215	12/72	18 Cr	566682

Butter dish

Beurrier • Boterschaal • Butterschale • Portaburro • Mantequera • Pojemnik na masł • Маслёнка • Βουτιριέρα

Ref	a	b	d	h	i	e	gr	Master (Pcs)	Steel	EAN 5413521+
508	55	90		75		0,6	208	54	18/10	005082



Soup bowl

Bol à potage • Soepkom • Suppenschale • Zuppiera • Sopa de contenedores • Mieczka Na Zupę
• Суповая миска • Μπόλ σούπας

Ref	a	b	d	h	i	e	gr	Master (Pcs)	Steel	EAN 5413521+
730	130	150		65	45	1,0	161	10/100	18/10	007307
730-E	130	150		65	45	1,0	169	10/100	14/1	300071



Gravy boat

Saucière • Sauskom • Sauciere • Salsiera • Salsera • Sosjerka
• Соусник • Σαλτσιέρα

Ref	a	b	d	h	i	e	gr	Master (Pcs)	Steel	EAN 5413521+
401		190	87	52	22	0,7	79	24/192	18/10	004016

Gravy boat

Saucière • Sauskom • Sauciere • Salsiera • Salsera
• Sosjerka • Соусник • Σαλτσιέρα

Ref	a	b	d	h	i	e	gr	Master (Pcs)	Steel	EAN 5413521+
1514		170	75	78	14	0,7	137	12/96	18/10	015142
1522		220	95	90	22	0,7	380	10/60	14/1	015227



Bowl

Ramequin • Schaaltje • Schale • Ciotola • Ramekin • Miseczka • Чаша
• Μπολ

Ref	a	b	d	h	i	e	gr	Master (Pcs)	Steel	EAN 5413521+
2940		100		40		1,0	91	50/200	18/10	029408



Ice cream cup

Coupe à glace • Ijsbeker • Eisbecher • Coppetta da gelato •
Copa helado • Pucharek do lodów • Вазочка для мороженого •
Κούπα παγωτού

Ref	a	b	d	h	i	e	gr	Master (Pcs)	Steel	EAN 5413521+
3010	100	104		52		0,8	76	20/160	18/10	030107
3010-E	100	104		52		0,8	84	20/160	14/1	100305

Egg cup

Coquetier • Eierdopje • Eierbecher • Portauovo • Huevero • Kieliszek do jaj •
Подставка для яйца • Αυγουλιέρα

Ref	a	b	d	h	i	e	gr	Master (Pcs)	Steel	EAN 5413521+
2300	49	50		52		0,5	28	60/600	14/1	023000



Sugar dispenser

Sucrier doseur • Suikerdoseerder • Zuckerstreuer • Dosatore zucchero • Azucarero dosificador •
Dozownik do cukru • Сахаря распылитель • Δοσομετρητής ζάχαρης

Ref	a	b	d	h	i	e	gr	Master (Pcs)	Steel	EAN 5413521+
3125		130	70	135	18		209	60	18 Cr	031258



Bottle coaster

Sous-bouteille • Fles onderzetter • Flaschenuntersetzer •
Sottobottiglia • Posa botella • Podstawka pod butelkę •
Подставки для бутылки • Σουβέρ για μπουκάλια



Ref	a	b	d	h	i	e	gr	Master (Pcs)	Steel	EAN 5413521+
1801	110	130		6		0,6	62	60/240	18/10	018013

Table cloth clip

Attache-nappe • Tafelkleed clip • Tischtuchhalter • Fermatovaglia •
Tie mantel • Klips Do Obrusów • Галстук скатерть • Клип
τραπεζομάντηλου

Ref	a	b	d	h	i	e	gr	Master (Pcs)	Steel	EAN 5413521+
793							60	12/192	18 Cr	007932



Seafood plate stand

Support plateau fruits de mer • Staander zeevruchtenschotel • Meeresfrüchte Plattenständer • SUPPorto per piatto di frutti di mare • Soporte bandeja de mariscos • Aca na owoce morz • Подставка для блюда с морепродуктами • Βάση πιάτου θαλασσινών

Ref	a	b	d	h	i	e	gr	Master (Pcs)	Steel	EAN 5413521+
3400	195	285		200			300	64	chromed	034006



Mussel dish

Plat à moules • Mosselschotel • Muschelteller • Piatto per mitil • Fuente para mejillones • Talerz na małże • Блюдо для мидий • Πιάτο μυδιών

Ref	a	b	d	h	i	e	gr	Master (Pcs)	Steel	EAN 5413521+
425	220	250		10		1,0	440	10/50	18/10	004252

Lobster cracker

Pince à homard • Kreeftenschaar • Hummerschere • Pinza per aragosta • Pinza bogavante • Szczypce do homarów • Злоумышленник омара • Σπαστήρας αστακού

Ref	a	b	d	h	i	e	gr	Master (Pcs)	Steel	EAN 5413521+
3015	157						102	50		030152



Champagne bucket

Seau à champagne • Champagnekoeler • Sektkühler • Secchiello per champagne • Cubo de champán • Wiaderko na szampana • Ведёрко для шампанского • Σαμπανιέρα

Ref	a	b	d	h	i	e	gr	Master (Pcs)	Steel	EAN 5413521+
2905	198			210	400	0,4	560	24	14/1	029057



Champagne bucket

Seau à champagne • Champagnekoeler • Sektkühler • Secchiello per champagne • Cubo de champán • Wiaderko na szampana • Ведёрко для шампанского • Σαμπανιέρα

Ref	a	b	d	h	i	e	gr	Master (Pcs)	Steel	EAN 5413521+
2904	190			190	325	1,0	540	5/30	18 Cr	029040

Wine valet

Porte-seau • Koelemmersteun • Kühlertischhalter • Porta bottiglia • Soporte cubo • Podstawka pod wiaderk • Поддержка де ведро • σετ σερβιρίσματος κρασιού

Ref	a	b	d	h	i	e	gr	Master (Pcs)	Steel	EAN 5413521+
3302	165						600	1	18/10	033023



Sugar bowl "bistrot"

Sucrier • Suikerpot • Zuckerdose • Zucheriera • Azucarero • Cukiernica • Сахарница • Ζαχαριέρα

Ref	a	b	d	h	i	e	gr	Master (Pcs)	Steel	EAN 5413521+
899	127			145		0,5	347	24	18/10	008991



Ashtray

Cendrier • Asbak • Aschenbecher • Portacenere • Cenicero • Popielniczka • Пепельница • Τασάκι

Ref	a	b	d	h	i	e	gr	Master (Pcs)	Steel	EAN 5413521+
608		80		29		1,5	111	12/120	18/10	006089

Spaghetti tong

Pince à spaghetti • Spaghettitang • Spaghettizzange • Pinza per spaghetti • Pinza espaguetis • Szczyrpsc do spaghetti • Щипцы для спагетти • Λαβίδα μακαρονιών

Ref	a	b	d	h	i	e	gr	Master (Pcs)	Steel	EAN 5413521+
2926	210					0,8	84	144	18/10	029262



Utility tong

Pince • Tang • Zange • Pinza • Pinza • Szczypce • Блюдо • Λαβίδα

Ref	a	b	d	h	i	L	mm	Master (Pcs)	Steel	EAN 5413521+
3117	230					0,5	70	100	18 Cr	031173
3117S	230					0,5	77	12/300	18 Cr	031173
3119	400					0,8	126	24/144	18 Cr	031197



Basting spoon

Cuillère à ragout • Groentenlepel • Ragoutlöffel • Cucchiaino da ragout • Cuchara servir
• Łyżka do gulaszu • Ложка для подливки • Κουτάλι περιχύσεως

Ref	a	b	d	h	i	e	gr	Master (Pcs)	Steel	EAN 5413521+
785	315					2,0	120	12/144	18 Cr	007857
785P	315					2,0	119	12/144	18 Cr	078512

Waffle fork

Fourchette à gaufre • Wafelvork • Waffelgabel • Forchetta per wafel • Banda de waffle • Widelec do gofrów • Группа вафельные • Πιρούνι Wafel

Ref	a	b	d	h	i	e	gr	Master (Pcs)	Steel	EAN 5413521+
792		350				4,0	55	100	18/10	007925



Cake tong

Pince à gâteau • Gebakjestang • Gebäckzange • Pinza per dolci • Pinza pastel • Szczyrce do ciastek • Щипцы для торта • Λαβίδα γλυκού

Ref	a	b	d	h	i	e	gr	Master (Pcs)	Steel	EAN 5413521+
3115		195				1,5	77	24/240	18 Cr	031159



Antifreeze ice cream scoop

Portionneur à glace • Ijschepper • Eisportionierer • Cucchiaino dosatore per gelato • Racionador • Dozownik do lodu • Лопатка для мороженого • Κουτάλι σερβιρίσματος παγωτού

Ref	a	b	d	h	i	e	gr	Master (Pcs)	Steel	EAN 5413521+
3001	175						136	12/144	Alu	030015

Ice cream scoop

Portionneur à glace • Ijschepper • Eisportionierer • Cucchiaino dosatore per gelato • Racionador • dozownik do lodu • Лопатка для мороженого • Κουτάλι σερβιρίσματος παγωτού

Ref	a	b	d	h	i	e	gr	Master (Pcs)	Steel	EAN 5413521+
3002-45	45				35	1,0	123	24/144	18/10	530027
3002-50	50				40	1,0	133	24/144	18/10	030022
3002-56	56				53	1,0	154	24/144	18/10	630024



Zakouski spoon

	Length (mm)	Gage (mm)	Master (Pcs)	Steel	EAN : 5413521+
1900-34	118	1,8	300	18 Cr	900349
1420-34	117	2,0	300	18/10	420342
973-34	124	2,0	300	18/10	973343



Zakouski fork

	Length (mm)	Gage (mm)	Master (Pcs)	Steel	EAN : 5413521+
958-39	117	1,8	12/600	18 Cr	958395

Steak knife ABS handle

Couteau steak • Steakmes • Steakmesser • Coltello Da Bistecca • Cuchillo de carne •
Nóż do steków • Нож для бифштекса • Μαχαίρι Μπριζόλας

	Length (mm)	Gage (mm)	Master (Pcs)	Steel	EAN : 5413521+
763	215	-	12/72/504	13 Cr	007635



Tapas

	Length (mm)	Gage (mm)	Master (Pcs)	Steel	EAN : 5413521+
2111731	200	2,0	12/300	18 Cr	117310
391059	99	2,0	12/300	18/10	910591
207059	102	1,0	12/300	118 Cr	070592



Tapas

	Length (mm)	Gage (mm)	Master (Pcs)	Steel	EAN : 5413521+
291161	121	1,5	12/300	18 Cr	911611
104192	98	1,2	12/300	18 Cr	041929

Tapas

	Length (mm)	Gage (mm)	Master (Pcs)	Steel	EAN : 5413521+
207760	125	1,2	12/300	18 Cr	077607
291162	124	1,5	12/300	18 Cr	911628
207765	111	1,2	12/300	18 Cr	077652



Paring & bread knife

Couteau à éplucher / à pain • Groenten & broodmes • Gemüse & Brotmesser •
Coltello da cucina & pane • Recortes y cuchillo de pan • Nóż do obierania/do chleba
• Кожура и хлебный нож • Μαχαίρι Ξεφλουδίσματος & Ψωμιού

	Length (mm)	Gage (mm)	Master (Pcs)	Steel	EAN : 5413521+
5320	200	-	1	13 Cr	053205
5307	70	-	1	13 Cr	053076



Lobster fork (set of 12)

Curette à homard • Kreeftvork • Hummergabel • Forchetta per aragosta • Tenedor bogavante •
Widelec do homarów • Вилочка для омара • Πιρούνι αστακού

	Length (mm)	Gage (mm)	Master (Pcs)	Steel	EAN : 5413521+
783	187	2,0	50	18 Cr	007833

Periwinkle skewers (set of 12)

Piques à bigorneaux • Kreukelprikkers • Strandschnecken Spiesser • Spiedinl •
Recoge bigaros • Widelec do ślimaków • Дама морщин • Διαλέγει θάλασσα σαλιγκάρια

	Length (mm)	Gage (mm)	Master (Pcs)	Steel	EAN : 5413521+
3017	71	-	167	18 Cr	030176





Grapefruit spoon

Cuillère à agrumes • Citrusvruchtenlepel • Zitrusfrüchtelöffel • Cucchiaio per pompelmo • Cuch. para Cítricos • Łyżeczka do cytrusów • грейпфрут ложкой • Κουτάλι γκρέιπφρουτ

	Length (mm)	Gage (mm)	Master (Pcs)	Steel	EAN : 5413521+
784	145	2,0	12/600	18 Cr	007840

Absinth spoon

Cuillère à absinthe • Absintlepel • Absinthlöffel • Cucchiaio per assenzio • Pala a absenta • Łopatka do absyntu • Ложка для абсента • Κουτάλι αφεντιού





































	Length (mm)	Gage (mm)	Master (Pcs)	Steel	EAN : 5413521+
771	167	1,0	12/600	18/10	007710



eternum 
created 1924



Chaussée de Tirlemont 66 - B-5030 Gembloux Belgium - www.eternum.com

1		table fork	fourchette table	tafelvork	Tafelgabel	forchetta da tavola	tenedor de mesa	widelec	столовая вилка	επιτραπέζιο πιρούνι
2		table spoon	cuillère table	tafellepel	Tafellöffel	cucchiaio da tavola	cuchara de mesa	łyżka stołowa	столовая ложка	επιτραπέζιο κουτάλι
5		table knife SH	couteau table MB	tafelmes monobloc	Tafelmesser monobloc	coltello da tavola impugnatura piena	cuchillo de mesa	nóż stołowy z litą rączką	столовый нож с массивной ручкой	επιτραπέζιο μαχαίρι με συμπαγή λαβή
51		table knife HH	couteau table MC	tafelmes holheft	Tafelmesser HH	coltello da tavola a manico cavo	cuchillo de mesa MH	nóż stołowy z pustą rączką	столовый нож ПР	επιτραπέζιο μαχαίρι με κοίλη λαβή
14		dessert fork	fourchette dessert	dessertvork	Dessertgabel	forchetta da dolce	tenedor de postre	widelczyk deserowy	десертная вилка	πιρούνι επιδορπίου
15		dessert spoon	cuillère dessert	dessertlepel	Dessertlöffel	cucchiaio da dolce	cuchara de postre	łyżeczka deserowa	десертная ложка	κουτάλι επιδορπίου
6		dessert knife SH	couteau dessert MB	dessertmes monobloc	Dessertmesser monobloc	coltello da dolce impugnatura piena	cuchillo de postre	nóż deserowy z litą rączką	десертный нож с массивной ручкой	μαχαίρι επιδορπίου με συλ ¹ μαχαίρι επιδορπίου με κοίλη λαβή
61		dessert knife HH	couteau dessert MC	dessertmes holheft	Dessertmesser HH	coltello da dolce a manico cavo	cuchillo de postre MH	nóż deserowy z pustą rączką	десертный нож ПР	μαχαίρι επιδορπίου με κοίλη λαβή
3		tea spoon	cuillère à café	koffielepel	Fischservice (Gabel)	cucchiaino da tè	cuchara de café	łyżeczka do kawy	набор для раздачи рыбы (вилка)	κουτάλι τσαγιού
26		mocca spoon	cuillère moka	mokkalepel	Mokkalöffel	cucchiaino da caffè	cuchara de moka	łyżeczka do mokki	кофейная ложка	κουτάλι demi-tasse
4		cake fork	fourchette gâteau	taartvorkje	Kuchengabel	forchetta da torta	tenedor de pastel	widelczyk do ciasta	вилка для торта	πιρούνι γλυκού
16		fish fork	fourchette poisson	visvork	Fischgabel	forchetta da pesce	tenedor pescado	wideliec do ryby	вилка для рыбы	πιρούνι ψαριού
17		fish knife	couteau poisson	vismes	Fischmesser	coltello da scalco	cuchillo pescado	nóż do ryby	нож для рыбы	μαχαίρι ψαριού
33		soup spoon	cuillère à consommé	bouillonlepel	Kraftbrüהלöffel	cucchiaio da brodo	cuchara consomé	łyżka do bulionu	супная ложка	κουτάλι ζωμού
40		fruit/butter knife	couteau fruit/beurre	fruit/botermes	Früchte/Buttermesser	coltello per burro/frutta	cuchillo de frutas/mantequilla	nóż do owoców/masła	нож для фруктов	μαχαίρι φρούτου/βουτύρου
45		steak knife	couteau steak	steakmes	Steakmesser	coltello da bistecca	cuchillo de carne	nóż do steków	нож для бифштекса	μαχαίρι μπριζόλας
25		cocktail spoon	cuillère cocktail	cocktaillepel	Limonadenlöffel	cucchiaino da cocktail	cuchara de cóctel	łyżeczka do koktajlu	ложка для коктейля	κουτάλι κοκτέιλ
18		ice cream spoon	pelle à glace	ijslepel	Eislöffel	cucchiaino da gelato	cuchara helados	łyżka do lodów	ложка для мороженого	κουτάλι παγωτού
19		oyster fork	fourchette à huîtres	oestervork	Austerngabel	forchetta da ostrica	tenedor de ostra	wideliec do ostryg	вилка для устриц	πιρούνι στρειδιών
20		snail fork	fourchette à escargots	slakkenvork	Schnecken-gabel	forchetta per lumache	tenedor caracol	widelczyk do ślimaków	вилка для улиток	πιρούνι σαλιγκαριών
32		tasting spoon	cuillère à dégustation	degustatielepel	Gourmetlöffel	cucchiaio da assaggio	cuchara degustación	łyżeczka do degustacji	гастрономическая ложка	κουτάλι γευσιγνωσίας
34		zakouski spoon	cuillère zakouski	zakouskilepel	Zakouskilöffel	cucchiaio zakouski	cuchara zakouski	łyżka do zakąsek	ложка для закусок	κουτάλι ορεκτικών Zakouski
7		soup ladle	louche	pollepel	Suppenshöpfer	mestolo per zuppa	cucharón	chochla	поварешка	κουτάλα σούπας
8		cake server	pelle à tarte	taartschep	Tortenheber	paletta per dolce	pala de tarta	łopatka do ciasta	лопаточка для торта	σπάτουλα για τάρτες
9		chips server	pelle à frites	frittenschep	Frittenlöffel	paletta per patatine fritte	cuchara para fritos	łopatka do frytek	ложка для раздачи чипсов	φτυαράκι για τηγανητές πατάτες
10		salad server	service salade	slabestek	Salatbesteck	posate per insalata	servicio ensalada	sztućce do sałaty	набор для салата	сет σεβριρίματος σαλάτας
11		gravy ladle	cuillère à sauce	sauslepel	Saucenlöffel	mestolo per salse	cazo de salsa	łyżka do sosu	ложка для подливки	κουτάλα σάλτσας
12		serving spoon	cuillère service	opdienlepel	Servierlöffel	cucchiaio da servizio	cuchara servicio	łyżka wazowa	раздаточная ложка	κουτάλι σεβριρίματος
21		serving fork	fourchette service	opdienvork	Aufschnittgabel	forchetta da servizio	tenedor servicio	wideliec do serwowania	раздаточная ложка	πιρούνι σεβριρίματος
23		carving fork	fourchette à découper	voorsnijvork	Tranchiergabel	forchettone	tenedor para trinchar	wideliec do mięs	вилка для разделки	πιρούνι κοψίματος κρέατος
24		carving knife	couteau à découper	voorsnijmes	Tranchiermesser	coltello da scalco	cuchillo para trinchar	nóż do mięs	нож для разделки	μαχαίρι κοψίματος κρέατος
27b		butter knife	couteau beurre	botermes	Buttermesser monobloc	coltello da burro	cuchillo mantequilla	nóż do masła z litą rączką	нож для масла с массивной ручкой	μαχαίρι βουτύρου με συμπαγή λαβή
27		butter knife HH	couteau tartineur MC	botersmeemes	Buttermesser	coltello da burro con impugnatura piena	cuchillo mantequilla MH	nóż do masła z pustą rączką	нож для масла с поллой ручкой (ПР)	μαχαίρι βουτύρου
28		cheese knife	couteau fromage	kaasmes	Käsmesser	coltello da formaggio a manico cavo	cuchillo queso MH	nóż do sera z pustą rączką	нож для сыра ПР	μαχαίρι τυριού με κοίλη λαβή
29		cake knife	couteau tarte	taartmes	Tortenmesser	coltello da torta a manico cavo	cuchillo pastel MH	nóż do ciast z pustą rączką	нож для торта ПР	μαχαίρι γλυκού με κοίλη λαβή
30		fish serving fork	fourchette service poisson	visservevork	Fischservice (Gabel)	forchetta per servire il pesce	tenedor de servicio pescado	wideliec do serwowania ryby	набор для раздачи рыбы (вилка)	πιρούνι σεβριρίματος ψαριού
31		fish serving knife	couteau service poisson	visserveermes	Fischservice (Messer)	coltello per servire il pesce	cuchillo de servicio pescado	nóż do serwowania ryby	набор для раздачи рыбы (нож)	μαχαίρι σεβριρίματος ψαριού